



**Shenzhen CTA Testing Technology Co., Ltd.**

Room 106, Building 1, Yibaolai Industrial Park, Qiaotou Community, Fuhai Street, Bao'an District, Shenzhen, China

**FCC PART 15 SUBPART C TEST REPORT**

**FCC PART 15.247**

**Report Reference No.**.....: **CTA22061000201**

**FCC ID**.....: **2A6P9-WUA1**

Compiled by

( position+printed name+signature) .: File administrators Kevin Liu

Supervised by

( position+printed name+signature) .: Project Engineer Kevin Liu

Approved by

( position+printed name+signature) .: RF Manager Eric Wang

Date of issue .....: Jun. 30, 2022



**Testing Laboratory Name** .....: **Shenzhen CTA Testing Technology Co., Ltd.**

Address .....: Room 106, Building 1, Yibaolai Industrial Park, Qiaotou Community, Fuhai Street, Bao' an District, Shenzhen, China

**Applicant's name**.....: **Promaster Electronic LLC**

Address .....: 25511 Budde Rd, Ste 1602. Spring, TX, 77380. USA

**Test specification** .....

Standard.....: **FCC Part 15.247**

TRF Originator.....: Shenzhen CTA Testing Technology Co., Ltd.

**Shenzhen CTA Testing Technology Co., Ltd. All rights reserved.**

This publication may be reproduced in whole or in part for non-commercial purposes as long as the Shenzhen CTA Testing Technology Co., Ltd. is acknowledged as copyright owner and source of the material. Shenzhen CTA Testing Technology Co., Ltd. takes no responsibility for and will not assume liability for damages resulting from the reader's interpretation of the reproduced material due to its placement and context.

**Test item description** .....

Trade Mark.....: Autosky

Manufacturer .....: Huizhou Funnavi Electronics Co., Ltd

Model/Type reference .....: WUA-1

Listed Models .....: N/A

Modulation Type.....: CCK/DSSS/ OFDM

Operation Frequency.....: From 2412 - 2462MHz

Rating .....: DC 5.0V From external circuit

Result .....: **PASS**

**Shenzhen CTA Testing Technology Co., Ltd.**

Room 106, Building 1, Yibaolai Industrial Park, Qiaotou Community, Fuhai Street, Bao'an District, Shenzhen, China  
Tel:+86-755 2322 5875 E-mail:cta@cta-test.cn Web:http://www.cta-test.cn

# TEST REPORT

Equipment under Test : Wireless CP adaptor

Model /Type : WUA-1

Series Model No. : N/A

Applicant : Promaster Electronic LLC

Address : 25511 Budde Rd, Ste 1602. Spring, TX, 77380. USA

Manufacturer : Huizhou Funnavi Electronics Co., Ltd

Address : 3rd floor, No.:25 Xiangda road Xiao Jin kou street, Huicheng district, Huizhou city, China

<b>Test Result:</b>	<b>PASS</b>
---------------------	-------------

The test report merely corresponds to the test sample.  
It is not permitted to copy extracts of these test result without the written permission of the test laboratory.

## Contents

<b>1</b>	<b><u>TEST STANDARDS .....</u></b>	<b>4</b>
<b>2</b>	<b><u>SUMMARY .....</u></b>	<b>5</b>
2.1	General Remarks	5
2.2	Product Description	5
2.3	Equipment Under Test	5
2.4	Short description of the Equipment under Test (EUT)	5
2.5	EUT operation mode	6
2.6	Block Diagram of Test Setup	6
2.7	Related Submittal(s) / Grant (s)	6
2.8	Modifications	6
<b>3</b>	<b><u>TEST ENVIRONMENT .....</u></b>	<b>7</b>
3.1	Address of the test laboratory	7
3.2	Test Facility	7
3.3	Environmental conditions	7
3.4	Test Description	8
3.5	Statement of the measurement uncertainty	8
3.6	Equipments Used during the Test	9
<b>4</b>	<b><u>TEST CONDITIONS AND RESULTS.....</u></b>	<b>10</b>
4.1	AC Power Conducted Emission	10
4.2	Radiated Emission	13
4.3	Maximum Peak Conducted Output Power	20
4.4	Power Spectral Density	22
4.5	6dB Bandwidth	28
4.6	Out-of-band Emissions	33
4.7	Antenna Requirement	46
<b>5</b>	<b><u>TEST SETUP PHOTOS OF THE EUT .....</u></b>	<b>47</b>
<b>6</b>	<b><u>PHOTOS OF THE EUT .....</u></b>	<b>48</b>

## 1 TEST STANDARDS

The tests were performed according to following standards:

[FCC Rules Part 15.247](#): Frequency Hopping, Direct Spread Spectrum and Hybrid Systems that are in operation within the bands of 902-928 MHz, 2400-2483.5 MHz, and 5725-5850 MHz.

[ANSI C63.10-2013](#): American National Standard for Testing Unlicensed Wireless Devices

[KDB558074 D01 v05r02](#): Guidance for Compliance Measurements on Digital Transmission Systems (DTS) ,Frequency Hopping Spread Spectrum System(HFSS), and Hybrid System Devices Operating Under §15.247 of The FCC rules.

## 2 SUMMARY

### 2.1 General Remarks

Date of receipt of test sample	:	Jun. 05, 2022
Testing commenced on	:	Jun. 05, 2022
Testing concluded on	:	Jun. 30, 2022

### 2.2 Product Description

Product Name:	Wireless CP adaptor
Model/Type reference:	WUA-1
Power supply:	DC 5.0V From external circuit
PC information (Auxiliary test supplied by testing Lab)	Model: TP00083A Input:AC 100-240V 50/60Hz Output:DC 20V 2.5A
PC Adapter information (Auxiliary test supplied by testing Lab)	Model: ADLX45NCC3A Input:AC 100-240V 50/60Hz Output:DC 20V 2.5A
testing sample ID:	CTA220610002-1# (Engineer sample), CTA220610002-2# (Normal sample)
Hardware version:	V1.0
Software version:	V1.0
<b>WIFI :</b>	
Supported type:	802.11b/802.11g/802.11n(H20)
Modulation:	802.11b: DSSS 802.11g/802.11n(H20): OFDM
Operation frequency:	802.11b/802.11g/802.11n(H20): 2412MHz~2462MHz
Channel number:	802.11b/802.11g/802.11n(H20): 11
Channel separation:	5MHz
Antenna type:	PCB antenna
Antenna gain:	0.00 dBi for Ant0 and Ant 1

### 2.3 Equipment Under Test

#### Power supply system utilised

Power supply voltage	:	<input type="radio"/> 230V / 50 Hz	<input type="radio"/> 120V / 60Hz
		<input type="radio"/> 5 V DC	<input type="radio"/> 24 V DC
		<input checked="" type="radio"/> Other (specified in blank below)	

DC 5.0V From external circuit

### 2.4 Short description of the Equipment under Test (EUT)

This is Wireless CP adaptor.

For more details, refer to the user's manual of the EUT.

**Shenzhen CTA Testing Technology Co., Ltd.**

Room 106, Building 1, Yibaolai Industrial Park, Qiaotou Community, Fuhai Street, Bao'an District, Shenzhen, China  
Tel:+86-755 2322 5875 E-mail:cta@cta-test.cn Web:http://www.cta-test.cn

## 2.5 EUT operation mode

The application provider specific test software(AT command) to control sample in continuous TX and RX (Duty Cycle >98%) for testing meet KDB558074 test requirement.

IEEE 802.11b/g/n: Thirteen channels are provided to the EUT.

Channel	Frequency(MHz)	Channel	Frequency(MHz)
1	2412	8	2447
2	2417	9	2452
3	2422	10	2457
4	2427	11	2462
5	2432		
6	2437		
7	2442		

## 2.6 Block Diagram of Test Setup

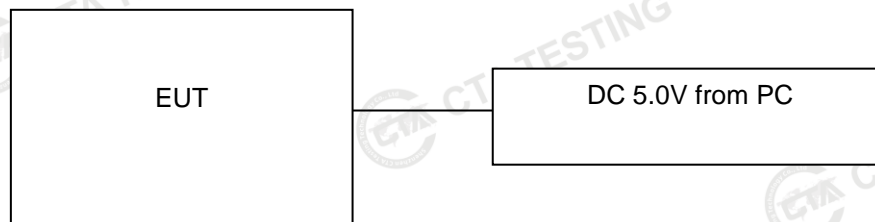

## 2.7 Related Submittal(s) / Grant (s)

This submittal(s) (test report) is intended for filing to comply with Section 15.247 of the FCC Part 15, Subpart C Rules.

## 2.8 Modifications

No modifications were implemented to meet testing criteria.

### 3 TEST ENVIRONMENT

#### 3.1 Address of the test laboratory

**Shenzhen CTA Testing Technology Co., Ltd.**

Room 106, Building 1, Yibaolai Industrial Park, Qiaotou Community, Fuhai Street, Bao'an District, Shenzhen, China

#### 3.2 Test Facility

The test facility is recognized, certified, or accredited by the following organizations:

**FCC-Registration No.: 517856 Designation Number: CN1318**

Shenzhen CTA Testing Technology Co., Ltd. has been listed on the US Federal Communications Commission list of test facilities recognized to perform electromagnetic emissions measurements.

**A2LA-Lab Cert. No.: 6534.01**

Shenzhen CTA Testing Technology Co., Ltd. has been listed by American Association for Laboratory Accreditation to perform electromagnetic emission measurement.

The 3m-Semi anechoic test site fulfils CISPR 16-1-4 according to ANSI C63.10 and CISPR 16-1-4:2010.

#### 3.3 Environmental conditions

During the measurement the environmental conditions were within the listed ranges:

Radiated Emission:

Temperature:	25 ° C
Humidity:	45 %
Atmospheric pressure:	950-1050mbar

Conducted testing:

Temperature:	25 ° C
Humidity:	44 %
Atmospheric pressure:	950-1050mbar

AC Power Conducted Emission

Temperature:	24 ° C
Humidity:	44 %
Atmospheric pressure:	950-1050mbar

### 3.4 Test Description

FCC PART 15.247		
FCC Part 15.207	AC Power Conducted Emission	PASS
FCC Part 15.247(a)(2)	6dB Bandwidth	PASS
FCC Part 15.247(d)	Spurious RF Conducted Emission	PASS
FCC Part 15.247(b)	Maximum Peak Conducted Output Power	PASS
FCC Part 15.247(e)	Power Spectral Density	PASS
FCC Part 15.109/ 15.205/ 15.209	Radiated Emissions	PASS
FCC Part 15.247(d)	Band Edge	PASS
FCC Part 15.203/15.247 (b)	Antenna Requirement	PASS

#### Data Rate Used:

Preliminary tests were performed in different data rate to find the worst radiated emission. The data rate shown in the table below is the worst-case rate with respect to the specific test item. Investigation has been done on all the possible configurations for searching the worst cases. The following table is a list of the test modes shown in this test report.

Test Items	Mode	Data Rate	Channel
Maximum Peak Conducted Output Power Power Spectral Density 6dB Bandwidth Spurious RF conducted emission Radiated Emission 9KHz~1GHz& Radiated Emission 1GHz~10 <sup>th</sup> Harmonic	11b/DSSS	1 Mbps	1/6/11
	11g/OFDM	6 Mbps	1/6/11
	11n(20MHz)/OFDM	6.5Mbps	1/6/11
Band Edge	11b/DSSS	1 Mbps	1/11
	11g/OFDM	6 Mbps	1/11
	11n(20MHz)/OFDM	6.5Mbps	1/11

### 3.5 Statement of the measurement uncertainty

The data and results referenced in this document are true and accurate. The reader is cautioned that there may be errors within the calibration limits of the equipment and facilities. The measurement uncertainty was calculated for all measurements listed in this test report acc. to TR-100028-01 "Electromagnetic compatibility and Radio spectrum Matters (ERM);Uncertainties in the measurement of mobile radio equipment characteristics; Part 1" and TR-100028-02 "Electromagnetic compatibility and Radio spectrum Matters (ERM);Uncertainties in the measurement of mobile radio equipment characteristics; Part 2 " and is documented in the Shenzhen CTA Testing Technology Co., Ltd. quality system acc. to DIN EN ISO/IEC 17025. Furthermore, component and process variability of devices similar to that tested may result in additional deviation. The manufacturer has the sole responsibility of continued compliance of the device.

Hereafter the best measurement capability for Shenzhen CTA Testing Technology Co., Ltd. :

Test	Range	Measurement Uncertainty	Notes
Radiated Emission	30~1000MHz	4.06 dB	(1)
Radiated Emission	1~18GHz	5.14 dB	(1)
Radiated Emission	18-40GHz	5.38 dB	(1)
Conducted Disturbance	0.15~30MHz	2.14 dB	(1)

- (1) This uncertainty represents an expanded uncertainty expressed at approximately the 95% confidence level using a coverage factor of k=2.



### 3.6 Equipments Used during the Test

Test Equipment	Manufacturer	Model No.	Equipment No.	Calibration Date	Calibration Due Date
LISN	R&S	ENV216	CTA-308	2021/08/06	2022/08/05
LISN	R&S	ENV216	CTA-314	2021/08/06	2022/08/05
EMI Test Receiver	R&S	ESPI	CTA-307	2021/08/06	2022/08/05
EMI Test Receiver	R&S	ESCI	CTA-306	2021/08/06	2022/08/05
Spectrum Analyzer	Agilent	N9020A	CTA-301	2021/08/06	2022/08/05
Spectrum Analyzer	R&S	FSP	CTA-337	2021/08/06	2022/08/05
Vector Signal generator	Agilent	N5182A	CTA-305	2021/08/06	2022/08/05
Analog Signal Generator	R&S	SML03	CTA-304	2021/08/06	2022/08/05
Universal Radio Communication	CMW500	R&S	CTA-302	2021/08/06	2022/08/05
Temperature and humidity meter	Chigo	ZG-7020	CTA-326	2021/08/06	2022/08/05
Ultra-Broadband Antenna	Schwarzbeck	VULB9163	CTA-310	2021/08/07	2022/08/06
Horn Antenna	Schwarzbeck	BBHA 9120D	CTA-309	2021/08/07	2022/08/06
Loop Antenna	Zhinan	ZN30900C	CTA-311	2021/08/07	2022/08/06
Horn Antenna	Beijing Hangwei Dayang	OBH100400	CTA-336	2021/08/06	2022/08/05
Amplifier	Schwarzbeck	BBV 9745	CTA-312	2021/08/06	2022/08/05
Amplifier	Taiwan chengyi	EMC051845B	CTA-313	2021/08/06	2022/08/05
Directional coupler	NARDA	4226-10	CTA-303	2021/08/06	2022/08/05
High-Pass Filter	XingBo	XBLBQ-GTA18	CTA-402	2021/08/06	2022/08/05
High-Pass Filter	XingBo	XBLBQ-GTA27	CTA-403	2021/08/06	2022/08/05
Automated filter bank	Tonscend	JS0806-F	CTA-404	2021/08/06	2022/08/05
Power Sensor	Agilent	U2021XA	CTA-405	2021/08/06	2022/08/05
Amplifier	Schwarzbeck	BBV9719	CTA-406	2021/08/06	2022/08/05

## 4 TEST CONDITIONS AND RESULTS

### 4.1 AC Power Conducted Emission

#### TEST CONFIGURATION

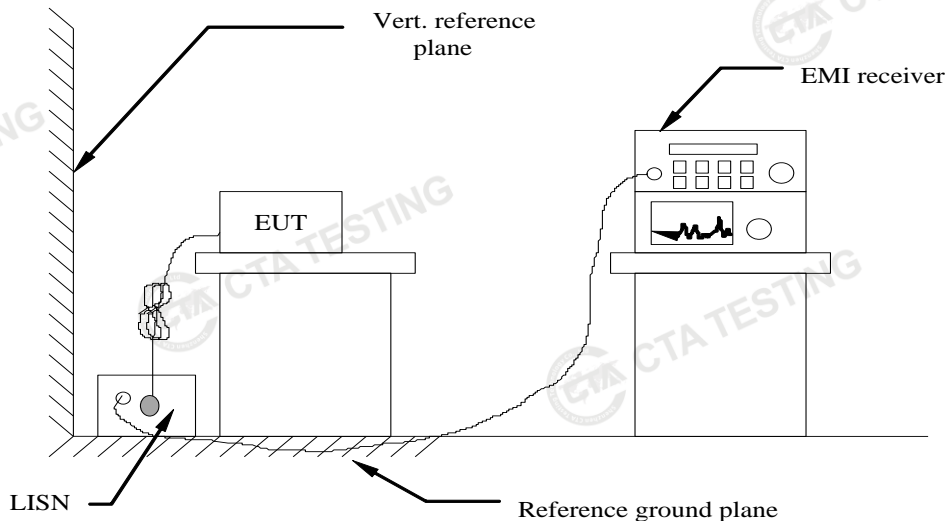

#### TEST PROCEDURE

- 1 The equipment was set up as per the test configuration to simulate typical actual usage per the user's manual. The EUT is a tabletop system, a wooden table with a height of 0.8 meters is used and is placed on the ground plane as per ANSI C63.10-2013.
- 2 Support equipment, if needed, was placed as per ANSI C63.10-2013
- 3 All I/O cables were positioned to simulate typical actual usage as per ANSI C63.10-2013
- 4 The EUT received power from adapter, the adapter received AC120V/60Hz and AC 240V/60Hz power through a Line Impedance Stabilization Network (LISN) which supplied power source and was grounded to the ground plane.
- 5 All support equipments received AC power from a second LISN, if any.
- 6 The EUT test program was started. Emissions were measured on each current carrying line of the EUT using a spectrum Analyzer / Receiver connected to the LISN powering the EUT. The LISN has two monitoring points: Line 1 (Hot Side) and Line 2 (Neutral Side). Two scans were taken: one with Line 1 connected to Analyzer / Receiver and Line 2 connected to a 50 ohm load; the second scan had Line 1 connected to a 50 ohm load and Line 2 connected to the Analyzer / Receiver.
- 7 Analyzer / Receiver scanned from 150 KHz to 30MHz for emissions in each of the test modes.
- 8 During the above scans, the emissions were maximized by cable manipulation.

#### AC Power Conducted Emission Limit

For intentional device, according to § 15.207(a) AC Power Conducted Emission Limits is as following :

Frequency range (MHz)	Limit (dBuV)	
	Quasi-peak	Average
0.15-0.5	66 to 56*	56 to 46*
0.5-5	56	46
5-30	60	50

\* Decreases with the logarithm of the frequency.

#### TEST RESULTS

Remark:

1. All modes of 802.11b/g/n were tested at Low, Middle, and High channel; only the worst result of 802.11b CH11 was reported as below:
2. Both 120 VAC, 50/60 Hz and 240 VAC, 50/60 Hz power supply have been tested, only the worst result of 120 VAC, 60 Hz was reported as below:

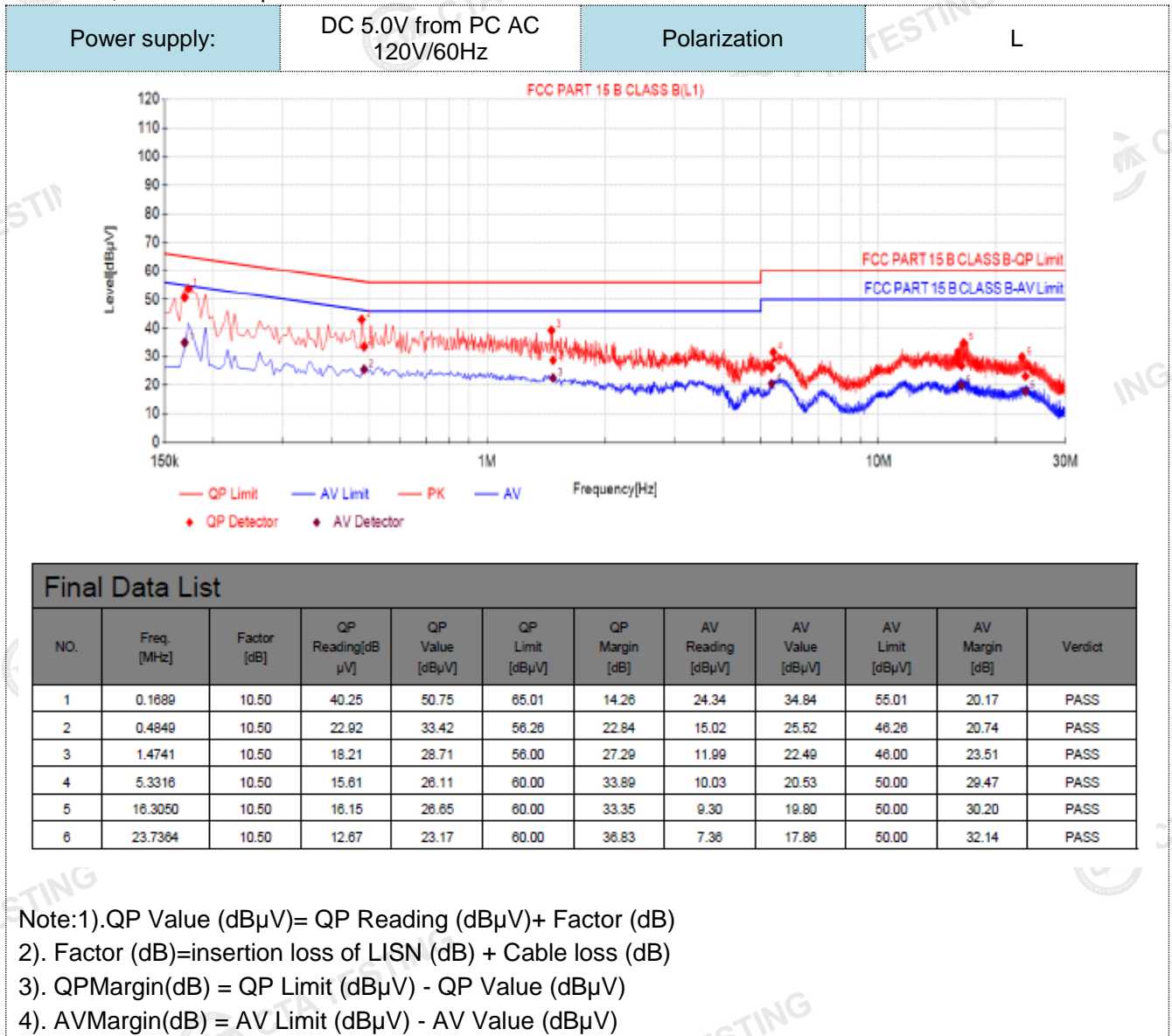

Power supply:	DC 5.0V from PC AC 120V/60Hz	Polarization	N
---------------	---------------------------------	--------------	---

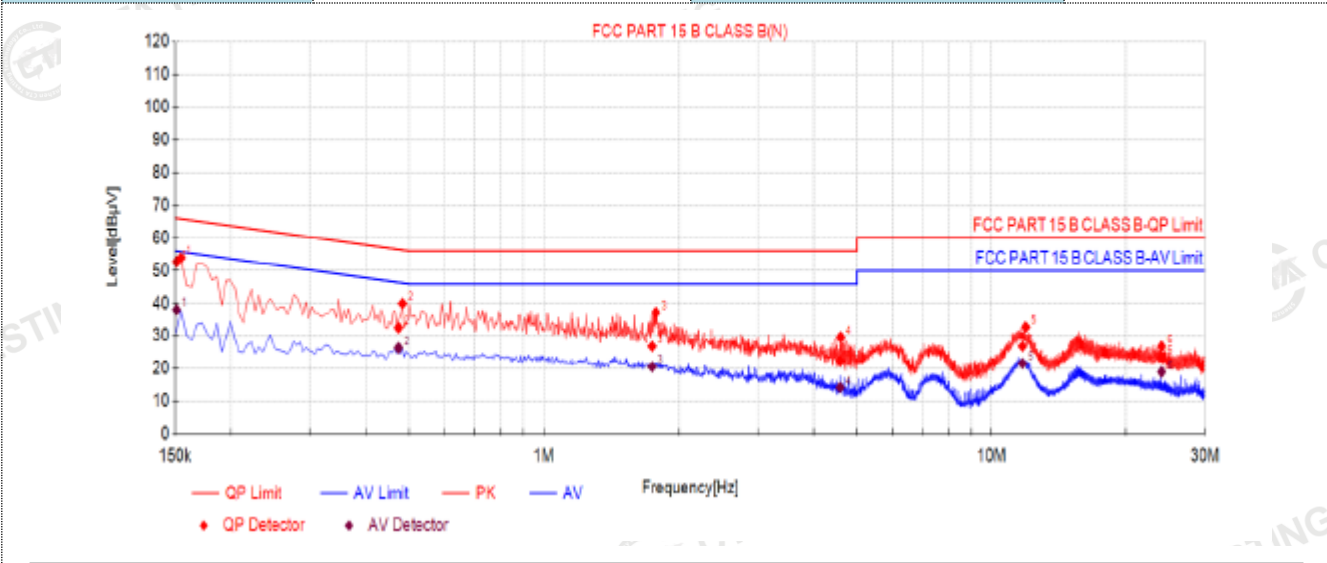

Final Data List											
NO.	Freq. [MHz]	Factor [dB]	QP Reading [dBµV]	QP Value [dBµV]	QP Limit [dBµV]	QP Margin [dB]	AV Reading [dBµV]	AV Value [dBµV]	AV Limit [dBµV]	AV Margin [dB]	Verdict
1	0.1510	10.50	42.16	52.66	65.94	13.28	27.52	38.02	55.94	17.92	PASS
2	0.4733	10.50	22.00	32.50	56.46	23.96	15.80	26.30	46.46	20.16	PASS
3	1.7443	10.50	16.27	26.77	56.00	29.23	10.05	20.55	46.00	25.45	PASS
4	4.5930	10.50	11.77	22.27	56.00	33.73	3.73	14.23	46.00	31.77	PASS
5	11.7360	10.50	16.27	26.77	60.00	33.23	11.06	21.56	50.00	28.44	PASS
6	24.0000	10.50	13.02	23.52	60.00	36.48	8.47	18.97	50.00	31.03	PASS

- Note:1).QP Value (dBµV)= QP Reading (dBµV)+ Factor (dB)
- 2). Factor (dB)=insertion loss of LISN (dB) + Cable loss (dB)
- 3). QPMargin(dB) = QP Limit (dBµV) - QP Value (dBµV)
- 4). AVMargin(dB) = AV Limit (dBµV) - AV Value (dBµV)

## 4.2 Radiated Emission

### TEST CONFIGURATION

Frequency range 9 KHz – 30MHz

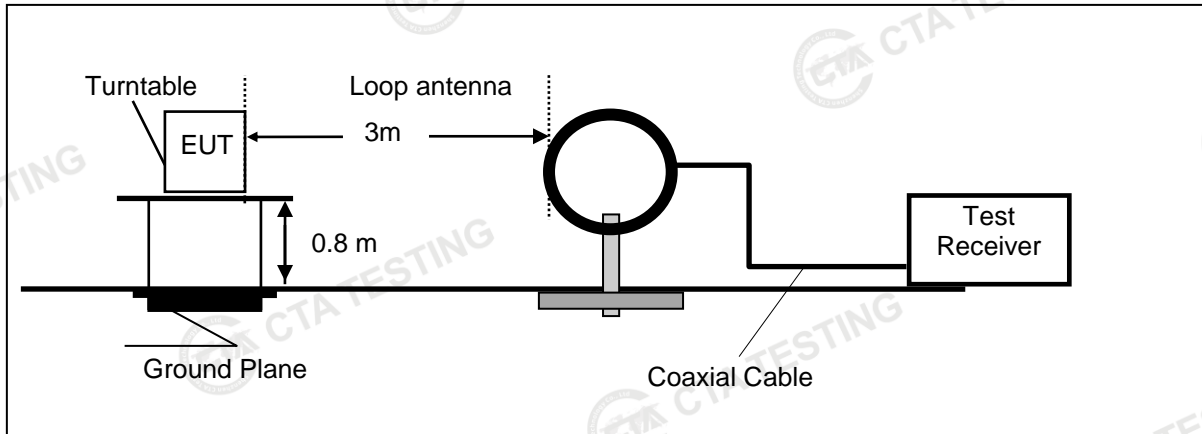

Frequency range 30MHz – 1000MHz

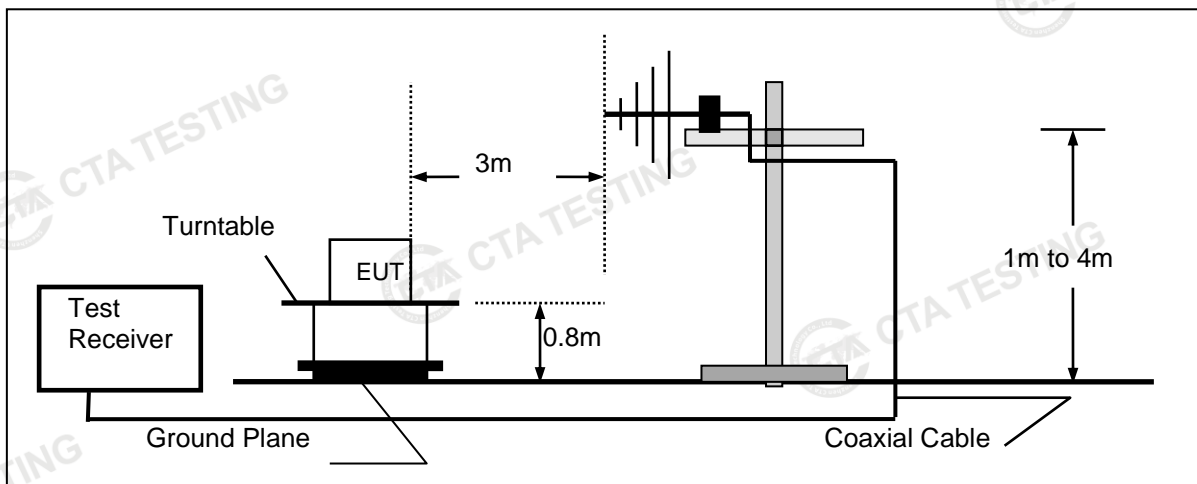

Frequency range above 1GHz-25GHz

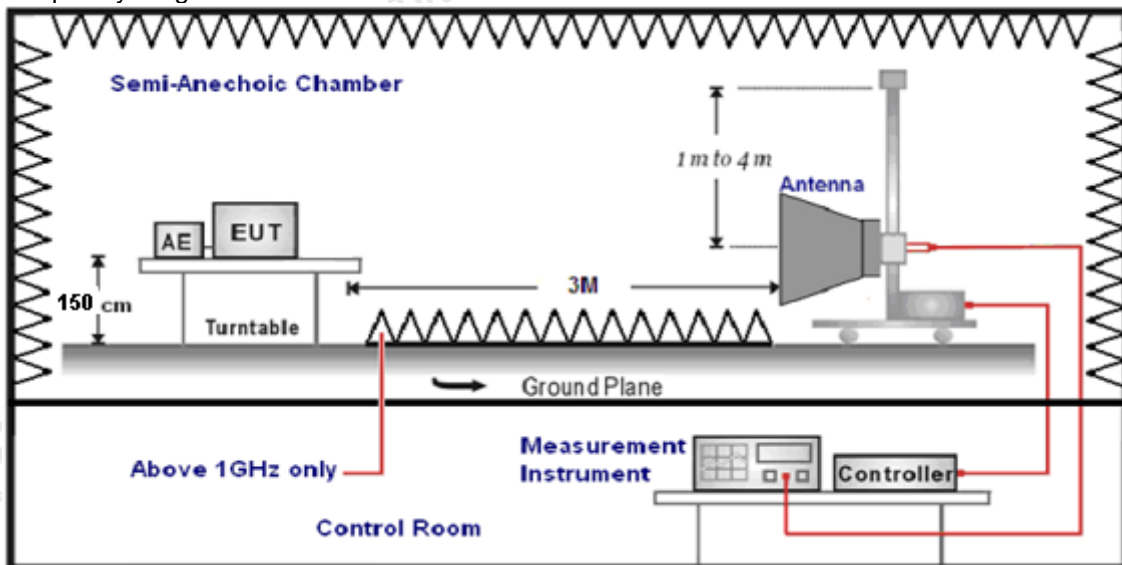

**TEST PROCEDURE**

1. The EUT was placed on a turn table which is 0.8m above ground plane when testing frequency range 9 KHz –1GHz;the EUT was placed on a turn table which is 1.5m above ground plane when testing frequency range 1GHz – 25GHz.
2. Maximum procedure was performed by raising the receiving antenna from 1m to 4m and rotating the turn table from 0° to 360° to acquire the highest emissions from EUT.
3. And also, each emission was to be maximized by changing the polarization of receiving antenna both horizontal and vertical.
4. Repeat above procedures until all frequency measurements have been completed.
5. Radiated emission test frequency band from 9KHz to 25GHz.
6. The distance between test antenna and EUT as following table states:

Test Frequency range	Test Antenna Type	Test Distance
9KHz-30MHz	Active Loop Antenna	3
30MHz-1GHz	Ultra-Broadband Antenna	3
1GHz-18GHz	Double Ridged Horn Antenna	3
18GHz-25GHz	Horn Antenna	1

7. Setting test receiver/spectrum as following table states:

Test Frequency range	Test Receiver/Spectrum Setting	Detector
9KHz-150KHz	RBW=200Hz/VBW=3KHz,Sweep time=Auto	QP
150KHz-30MHz	RBW=9KHz/VBW=100KHz,Sweep time=Auto	QP
30MHz-1GHz	RBW=120KHz/VBW=1000KHz,Sweep time=Auto	QP
1GHz-40GHz	Peak Value: RBW=1MHz/VBW=3MHz, Sweep time=Auto Average Value: RBW=1MHz/VBW=10Hz, Sweep time=Auto	Peak

**Field Strength Calculation**

The field strength is calculated by adding the Antenna Factor and Cable Factor and subtracting the Amplifier Gain and Duty Cycle Correction Factor(if any) from the measured reading. The basic equation with a sample calculation is as follows:

$$FS = RA + AF + CL - AG$$

Where FS = Field Strength	CL = Cable Attenuation Factor (Cable Loss)
RA = Reading Amplitude	AG = Amplifier Gain
AF = Antenna Factor	

$$Transd=AF +CL-AG$$

**RADIATION LIMIT**

For intentional device, according to § 15.209(a), the general requirement of field strength of radiated emission from intentional radiators at a distance of 3 meters shall not exceed the following table. According to § 15.247(d), in any 100kHz bandwidth outside the frequency band in which the EUT is operating, the radio frequency power that is produced by the intentional radiator shall be at least 20dB below that in the100kHz bandwidth within the band that contains the highest level of desired power.

The pre-test have done for the EUT in three axes and found the worst emission at position shown in test setup photos.

Frequency (MHz)	Distance (Meters)	Radiated (dBµV/m)	Radiated (µV/m)
0.009-0.49	3	20log(2400/F(KHz))+40log(300/3)	2400/F(KHz)
0.49-1.705	3	20log(24000/F(KHz))+ 40log(30/3)	24000/F(KHz)
1.705-30	3	20log(30)+ 40log(30/3)	30
30-88	3	40.0	100
88-216	3	43.5	150
216-960	3	46.0	200
Above 960	3	54.0	500

**TEST RESULTS**

Remark:

1. This test was performed with EUT in X, Y, Z position and the worse case was found when EUT in X position.
2. All three channels (lowest/middle/highest) of each mode were measured below 1GHz and recorded worst case at 802.11b low channel.
3. Radiated emission test from 9 KHz to 10th harmonic of fundamental was verified, and no emission found except system noise floor in 9 KHz to 30MHz and not recorded in this report.

**For 30MHz-1GHz**

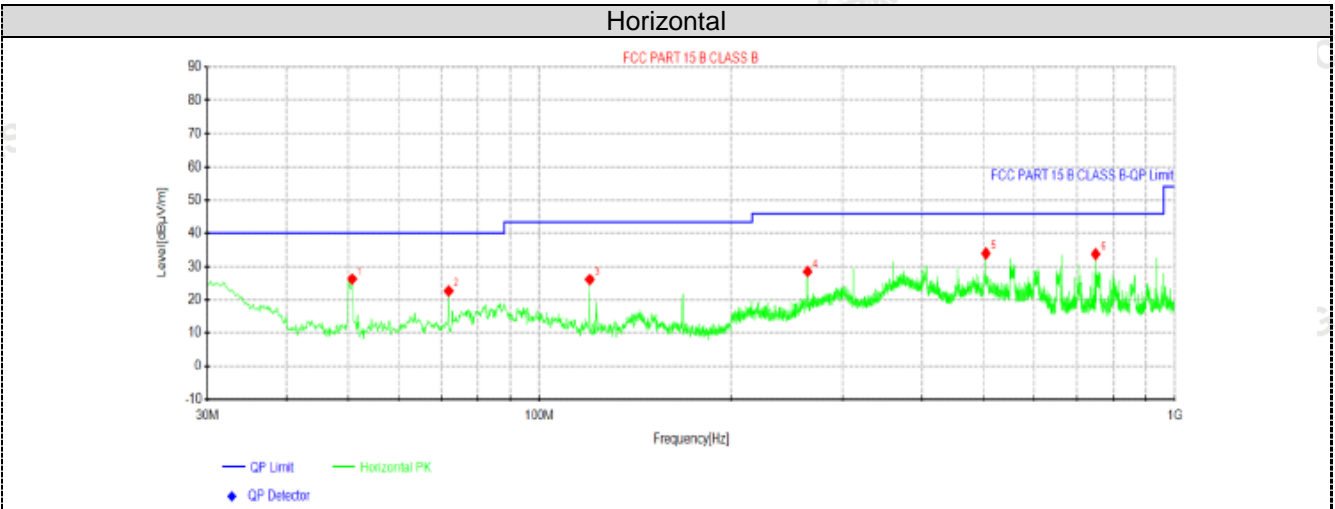

**Suspected Data List**

NO.	Freq. [MHz]	Reading [dBµV]	Level [dBµV/m]	Factor [dB/m]	Limit [dBµV/m]	Margin [dB]	Height [cm]	Angle [°]	Polarity
1	50.7338	42.43	26.21	-16.22	40.00	13.79	100	308	Horizontal
2	71.9525	43.61	22.64	-20.97	40.00	17.36	100	18	Horizontal
3	119.967	46.34	26.05	-20.29	43.50	17.45	100	97	Horizontal
4	264.012	46.29	28.56	-17.73	46.00	17.44	100	155	Horizontal
5	503.966	48.24	34.00	-14.24	46.00	12.00	100	347	Horizontal
6	750.103	44.46	33.79	-10.67	46.00	12.21	100	194	Horizontal

Note:1).Level (dBµV/m)= Reading (dBµV)+ Factor (dB/m)

2). Factor(dB/m)=Antenna Factor (dB/m) + Cable loss (dB) - Pre Amplifier gain (dB)

3). Margin(dB) = Limit (dBµV/m) - Level (dBµV/m)

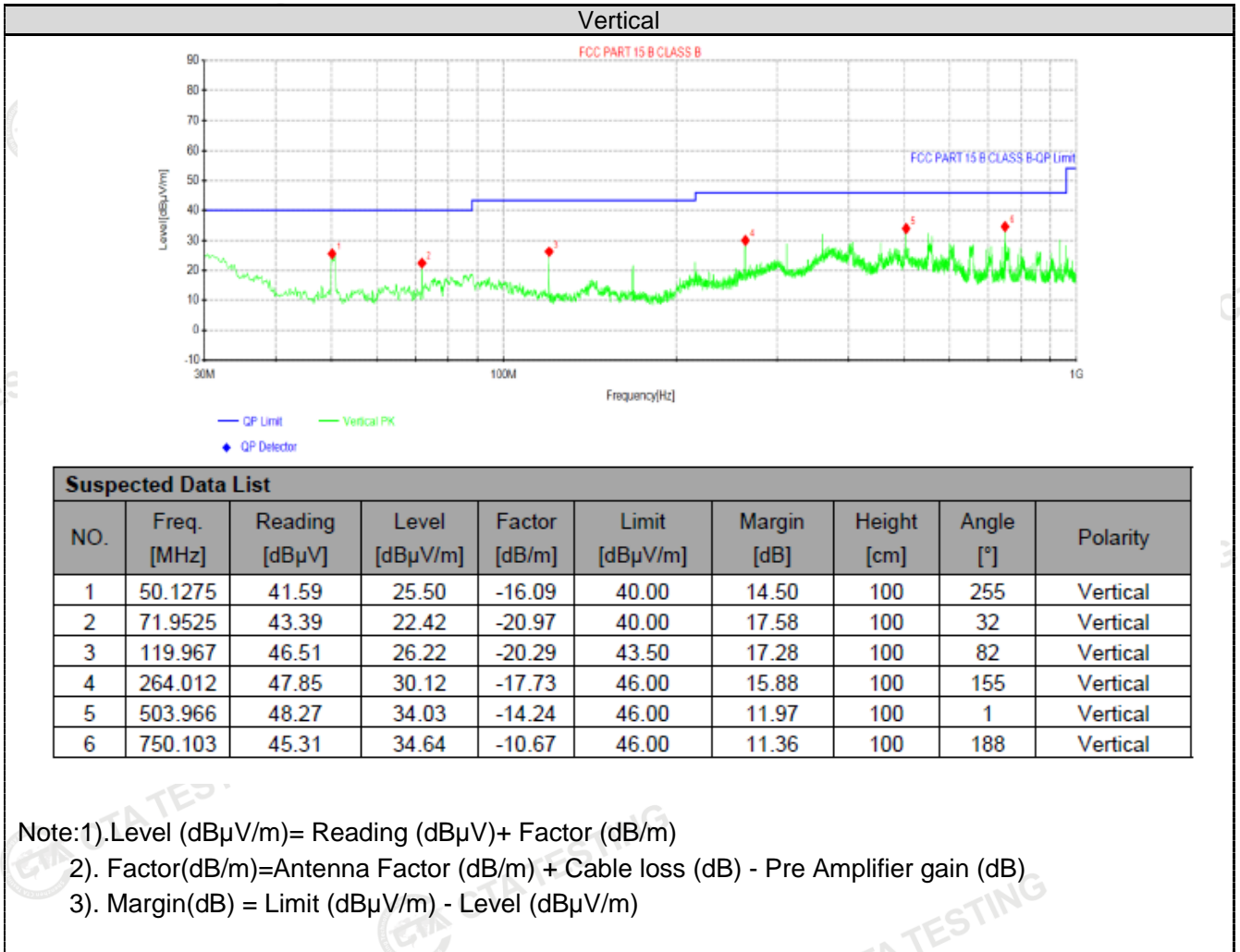



## For 1GHz to 25GHz

Note: 802.11b/802.11g/802.11n (H20) Mode all have been tested, only worse case 802.11b mode is reported

(above 1GHz)

Frequency(MHz):			2412		Polarity:		HORIZONTAL		
Frequency (MHz)	Emission Level (dBuV/m)		Limit (dBuV/m)	Margin (dB)	Raw Value (dBuV)	Antenna Factor (dB/m)	Cable Factor (dB)	Pre-amplifier (dB)	Correction Factor (dB/m)
4824.00	59.76	PK	74	14.24	64.1234	32.4	5.11	41.87	-4.36
4824.00	44.28	AV	54	9.72	48.6434	32.4	5.11	41.87	-4.36
7236.00	53.47	PK	74	20.53	54.1034	36.58	6.43	43.64	-0.63
7236.00	41.99	AV	54	12.01	42.6184	36.58	6.43	43.64	-0.63

Frequency(MHz):			2412		Polarity:		VERTICAL		
Frequency (MHz)	Emission Level (dBuV/m)		Limit (dBuV/m)	Margin (dB)	Raw Value (dBuV)	Antenna Factor (dB/m)	Cable Factor (dB)	Pre-amplifier (dB)	Correction Factor (dB/m)
4824.00	58.64	PK	74	15.36	63	32.4	5.11	41.87	-4.36
4824.00	43.16	AV	54	10.84	47.52	32.4	5.11	41.87	-4.36
7236.00	52.35	PK	74	21.65	52.98	36.58	6.43	43.64	-0.63
7236.00	40.87	AV	54	13.14	41.495	36.58	6.43	43.64	-0.63

Frequency(MHz):			2437		Polarity:		HORIZONTAL		
Frequency (MHz)	Emission Level (dBuV/m)		Limit (dBuV/m)	Margin (dB)	Raw Value (dBuV)	Antenna Factor (dB/m)	Cable Factor (dB)	Pre-amplifier (dB)	Correction Factor (dB/m)
4874.00	59.38	PK	74	14.62	63.3334	32.56	5.34	41.85	-3.95
4874.00	44.13	AV	54	9.87	48.0834	32.56	5.34	41.85	-3.95
7311.00	52.88	PK	74	21.12	53.2434	36.54	6.81	43.71	-0.36
7311.00	42.41	AV	54	11.59	42.7734	36.54	6.81	43.71	-0.36

Frequency(MHz):			2437		Polarity:		VERTICAL		
Frequency (MHz)	Emission Level (dBuV/m)		Limit (dBuV/m)	Margin (dB)	Raw Value (dBuV)	Antenna Factor (dB/m)	Cable Factor (dB)	Pre-amplifier (dB)	Correction Factor (dB/m)
4874.00	58.26	PK	74	15.74	62.21	32.56	5.34	41.85	-3.95
4874.00	43.01	AV	54	10.99	46.96	32.56	5.34	41.85	-3.95
7311.00	51.76	PK	74	22.24	52.12	36.54	6.81	43.71	-0.36
7311.00	41.29	AV	54	12.71	41.65	36.54	6.81	43.71	-0.36

Frequency(MHz):			2462		Polarity:		HORIZONTAL		
Frequency (MHz)	Emission Level (dBuV/m)		Limit (dBuV/m)	Margin (dB)	Raw Value (dBuV)	Antenna Factor (dB/m)	Cable Factor (dB)	Pre-amplifier (dB)	Correction Factor (dB/m)
4924.00	59.97	PK	74	14.03	63.4334	32.73	5.64	41.83	-3.46
4924.00	44.15	AV	54	9.85	47.6134	32.73	5.64	41.83	-3.46
7386.00	53.03	PK	74	20.97	53.0934	36.5	7.23	43.79	-0.06
7386.00	42.26	PK	54	11.74	42.3234	36.5	7.23	43.79	-0.06

Frequency(MHz):			2462		Polarity:		VERTICAL		
Frequency (MHz)	Emission Level (dBuV/m)		Limit (dBuV/m)	Margin (dB)	Raw Value (dBuV)	Antenna Factor (dB/m)	Cable Factor (dB)	Pre-amplifier (dB)	Correction Factor (dB/m)
4924.00	58.85	PK	74	15.15	62.31	32.73	5.64	41.83	-3.46
4924.00	43.03	AV	54	10.97	46.49	32.73	5.64	41.83	-3.46
7386.00	51.91	PK	74	22.09	51.97	36.5	7.23	43.79	-0.06
7386.00	41.14	PK	54	12.86	41.2	36.5	7.23	43.79	-0.06

Shenzhen CTA Testing Technology Co., Ltd.

Room 106, Building 1, Yibaolai Industrial Park, Qiaotou Community, Fuhai Street, Bao'an District, Shenzhen, China

Tel:+86-755 2322 5875 E-mail:cta@cta-test.cn Web:http://www.cta-test.cn

- 1) Emission level (dBuV/m) = Meter Reading+ antenna Factor+ cable loss- preamp factor.
- 2) Margin value = Limits-Emission level.
- 3) -- Mean the PK detector measured value is below average limit.
- 4) The other emission levels were very low against the limit.
- 5) RBW1MHz VBW3MHz Peak detector is for PK value; RBW 1MHz VBW10Hz Peak detector is for AV value.

**Results of Band Edges Test (Radiated)**

Note: 802.11b/802.11g/802.11n (H20) MIMO Mode all have been tested, only worse case 802.11b mode is reported

Frequency(MHz):			2412		Polarity:		HORIZONTAL		
Frequency (MHz)	Emission Level (dBuV/m)		Limit (dBuV/m)	Margin (dB)	Raw Value (dBuV)	Antenna Factor (dB/m)	Cable Factor (dB)	Pre-amplifier (dB)	Correction Factor (dB/m)
2390.00	59.89	PK	74	14.11	70.3134	27.42	4.31	42.15	-10.42
2390.00	43.13	AV	54	10.87	53.5534	27.42	4.31	42.15	-10.42
Frequency(MHz):			2412		Polarity:		VERTICAL		
Frequency (MHz)	Emission Level (dBuV/m)		Limit (dBuV/m)	Margin (dB)	Raw Value (dBuV)	Antenna Factor (dB/m)	Cable Factor (dB)	Pre-amplifier (dB)	Correction Factor (dB/m)
2390.00	58.77	PK	74	15.23	69.19	27.42	4.31	42.15	-10.42
2390.00	42.01	AV	54	11.99	52.43	27.42	4.31	42.15	-10.42
Frequency(MHz):			2462		Polarity:		HORIZONTAL		
Frequency (MHz)	Emission Level (dBuV/m)		Limit (dBuV/m)	Margin (dB)	Raw Value (dBuV)	Antenna Factor (dB/m)	Cable Factor (dB)	Pre-amplifier (dB)	Correction Factor (dB/m)
2483.50	59.44	PK	74	14.56	69.5534	27.7	4.47	42.28	-10.11
2483.50	41.22	AV	54	12.78	51.3334	27.7	4.47	42.28	-10.11
Frequency(MHz):			2462		Polarity:		VERTICAL		
Frequency (MHz)	Emission Level (dBuV/m)		Limit (dBuV/m)	Margin (dB)	Raw Value (dBuV)	Antenna Factor (dB/m)	Cable Factor (dB)	Pre-amplifier (dB)	Correction Factor (dB/m)
2483.50	58.32	PK	74	15.68	68.43	27.7	4.47	42.28	-10.11
2483.50	40.10	AV	54	13.90	50.21	27.7	4.47	42.28	-10.11

Note:

- 1) Emission level (dBuV/m) = Meter Reading+ antenna Factor+ cable loss- preamp factor.
- 2) Margin value = Limits-Emission level.
- 3) -- Mean the PK detector measured value is below average limit.
- 4) The other emission levels were very low against the limit.
- 5) RBW1MHz VBW3MHz Peak detector is for PK value; RBW 1MHz VBW10Hz Peak detector is for AV value.

### 4.3 Maximum Peak Conducted Output Power

#### Limit

The Maximum Peak Output Power Measurement is 30dBm.

#### Test Procedure

Remove the antenna from the EUT and then connect a low loss RF cable from the antenna port to the power sensor.

#### Test Configuration



#### Test Results

##### ANT 1

Type	Channel	Output power PK (dBm)	Limit (dBm)	Result
802.11b	01	8.21	30.00	Pass
	06	8.92		
	11	8.75		
802.11g	01	7.09	30.00	Pass
	06	7.67		
	11	7.36		
802.11n(HT20)	01	5.88	30.00	Pass
	06	5.96		
	11	5.89		

##### ANT 2

Type	Channel	Output power PK (dBm)	Limit (dBm)	Result
802.11b	01	8.13	30.00	Pass
	06	8.13		
	11	8.81		
802.11g	01	7.31	30.00	Pass
	06	7.29		
	11	7.60		
802.11n(HT20)	01	5.75	30.00	Pass
	06	5.88		
	11	5.96		

## Note:

- 1) Measured output power at difference data rate for each mode and recorded worst case for each mode.
- 2) Test results including cable loss.
- 3) Worst case data at 1Mbps at IEEE 802.11b; 6Mbps at IEEE 802.11g; 6.5Mbps at IEEE 802.11n HT20;

For MIMO:

Type	Channel	Output power PK(dBm) ANT1	Output power PK(dBm) ANT2	Output power PK(dBm) MIMO	Limit (dBm)	Result
802.11n(HT20)	01	5.88	5.75	8.83	30.00	Pass
	06	5.96	5.88	8.93		
	11	5.89	5.96	8.94		

#### 4.4 Power Spectral Density

##### Limit

For digitally modulated systems, the power spectral density conducted from the intentional radiator to the antenna shall not be greater than 8 dBm in any 3 kHz band during any time interval of continuous transmission.

##### Test Procedure

1. Use this procedure when the maximum peak conducted output power in the fundamental emission is used to demonstrate compliance.
2. Set the RBW  $\geq$  3 kHz.
3. Set the VBW  $\geq$  3 $\times$  RBW.
4. Set the span to 1.5 times the DTS channel bandwidth.
5. Detector = peak.
6. Sweep time = auto couple.
7. Trace mode = max hold.
8. Allow trace to fully stabilize.
9. Use the peak marker function to determine the maximum power level.
10. If measured value exceeds limit, reduce RBW (no less than 3 kHz) and repeat.
11. The resulting peak PSD level must be 8dBm.

##### Test Configuration



##### Test Results

###### ANT 1

Type	Channel	Power Spectral Density (dBm/3KHz)	Limit (dBm/3KHz)	Result
802.11b	01	-16.30	8.00	Pass
	06	-17.07		
	11	-18.10		
802.11g	01	-22.77	8.00	Pass
	06	-23.56		
	11	-24.65		
802.11n(HT20)	01	-24.22	8.00	Pass
	06	-25.06		
	11	-26.20		

###### ANT 2

Type	Channel	Power Spectral Density (dBm/3KHz)	Limit (dBm/3KHz)	Result
802.11b	01	-25.79	8.00	Pass
	06	-24.86		
	11	-24.06		
802.11g	01	-27.70	8.00	Pass
	06	-26.65		
	11	-25.26		
802.11n(HT20)	01	-27.92	8.00	Pass
	06	-27.13		
	11	-25.91		

Note:

- 1) Measured peak power spectrum density at difference data rate for each mode and recorded worst case for each mode.
- 2) Test results including cable loss;
- 3) Worst case data at 1Mbps at IEEE 802.11b; 6Mbps at IEEE 802.11g; 6.5Mbps at IEEE 802.11n HT20;

For MIMO:

Type	Channel	Power Spectral Density (dBm/3KHz) ANT1	Power Spectral Density (dBm/3KHz) ANT2	Power Spectral Density (dBm/3KHz) MIMO	Limit (dBm)	Result
802.11n(HT20)	01	-24.22	-27.92	-22.68	8.00	Pass
	06	-25.06	-27.13	-22.96		
	11	-26.20	-25.91	-23.04		

Please refer to following plots;

ANT 1

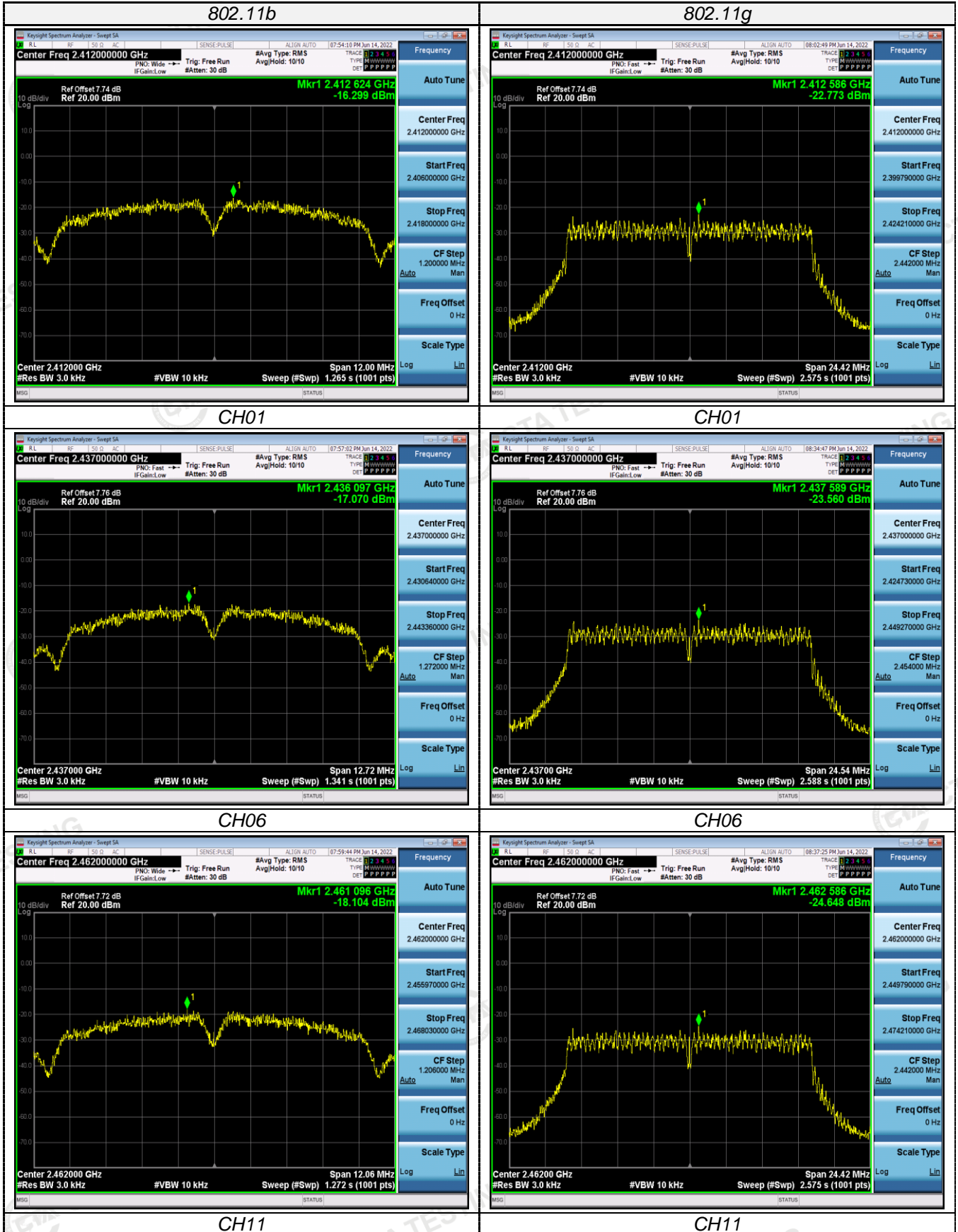



802.11n(HT20)

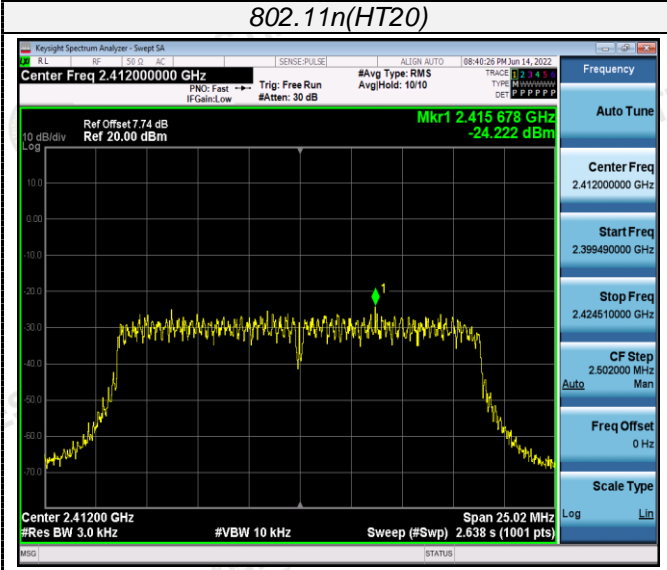

CH01

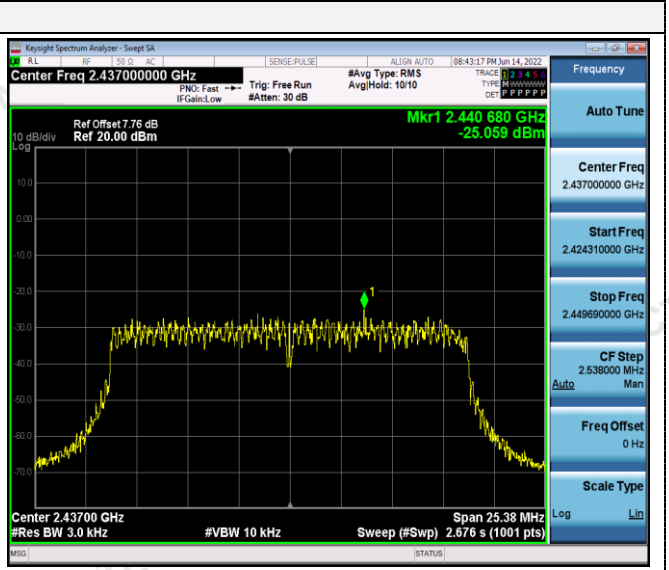

CH06

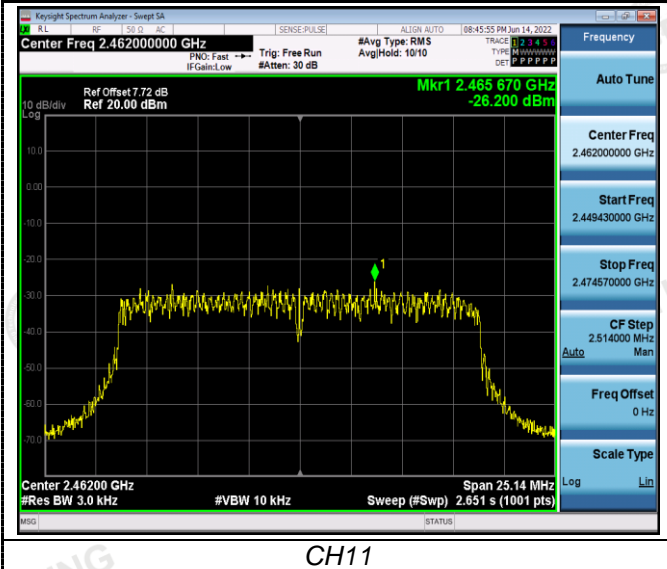

CH11

ANT 2

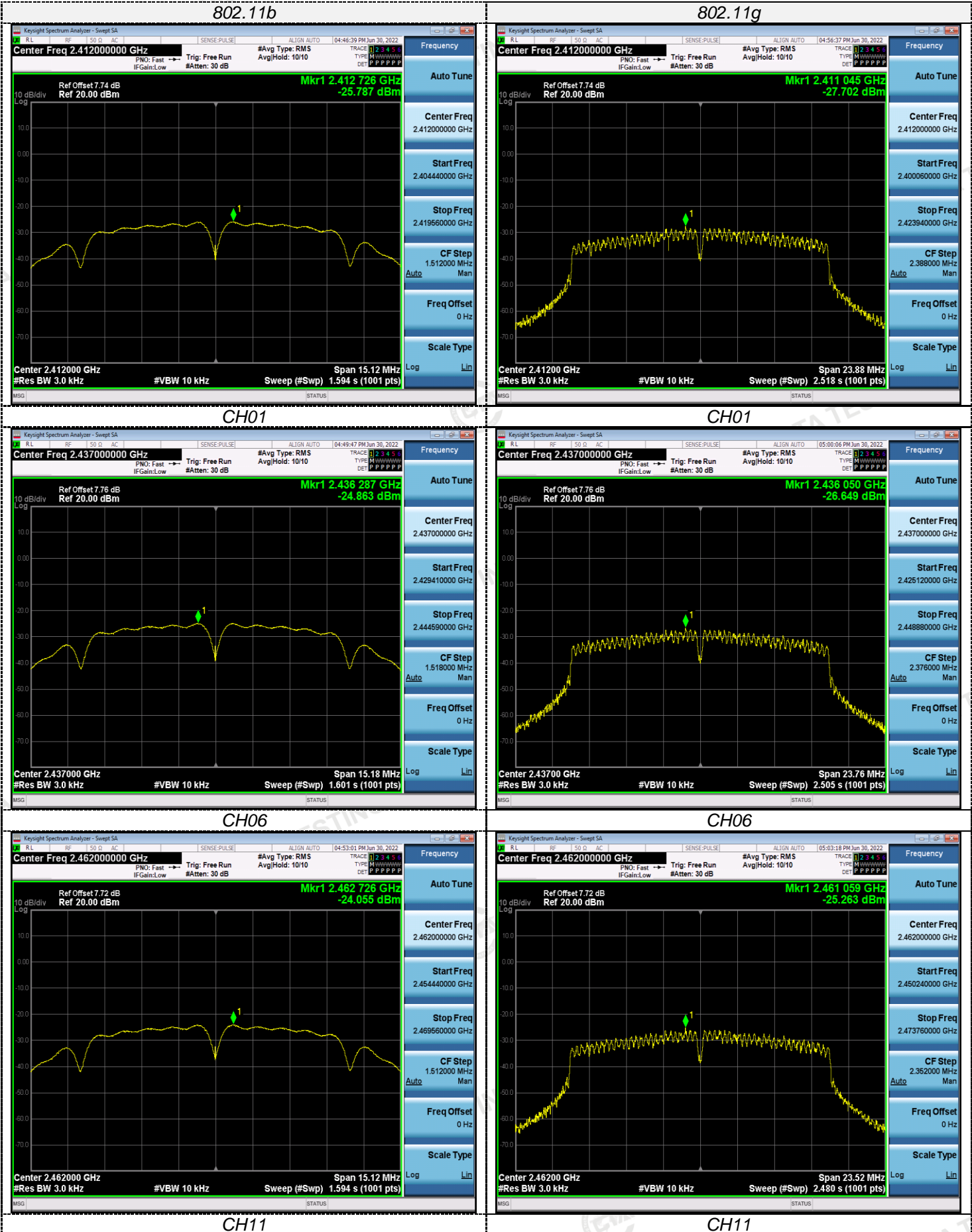

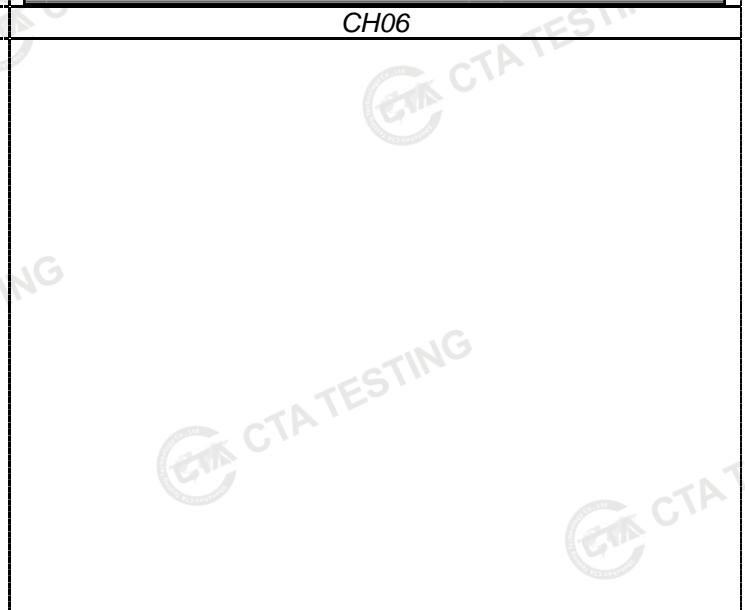
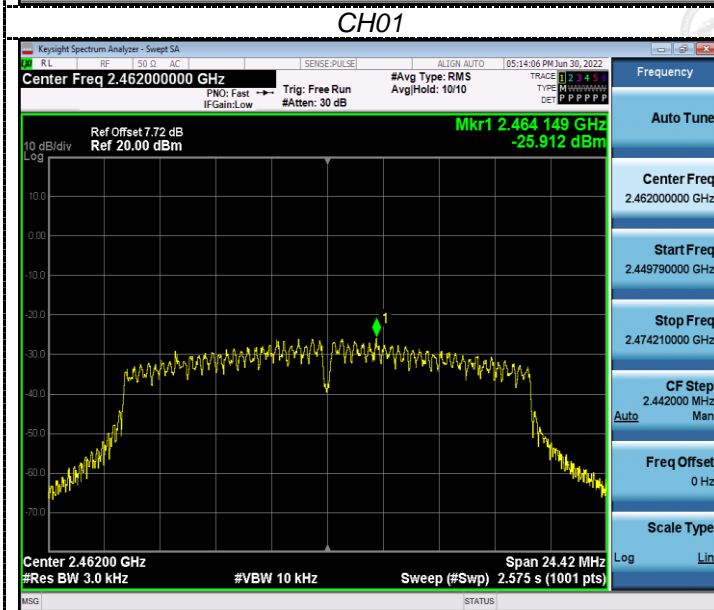
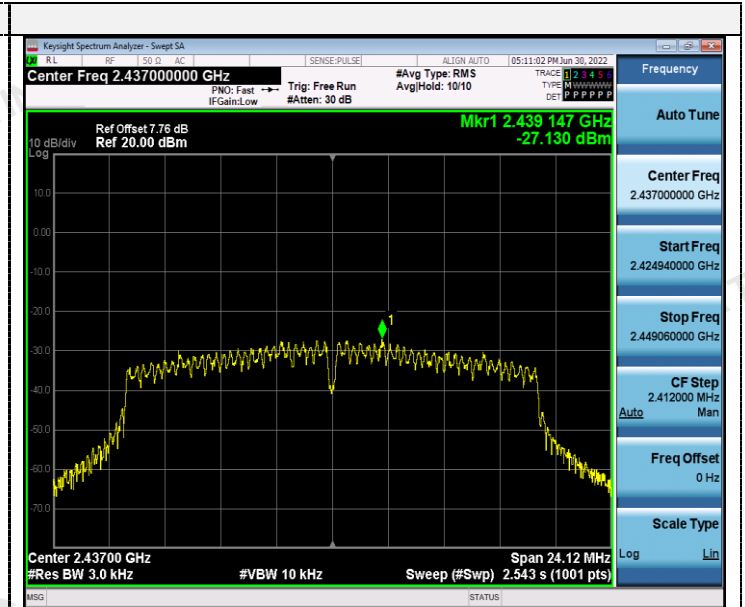
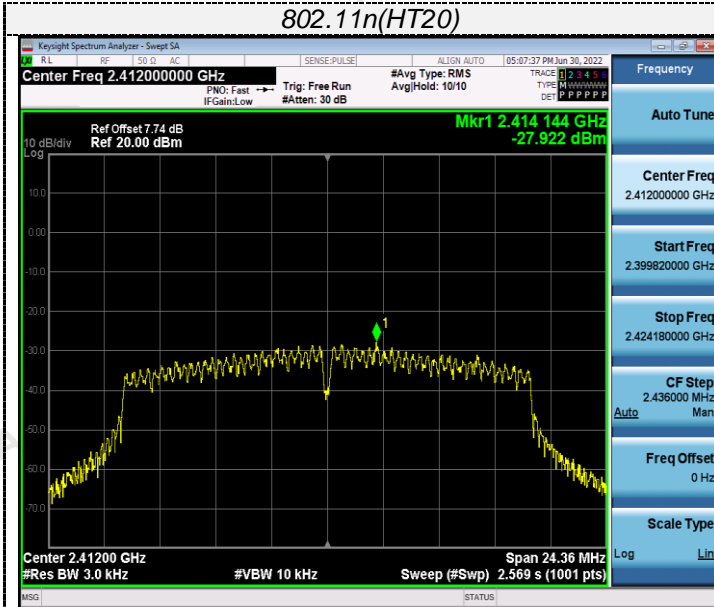

## 4.5 6dB Bandwidth

### Limit

For digital modulation systems, the minimum 6 dB bandwidth shall be at least 500 kHz

### Test Procedure

The transmitter output was connected to the spectrum analyzer through an attenuator. The bandwidth of the fundamental frequency was measured by spectrum analyzer with 100 KHz RBW and 300 KHz VBW. The 6dB bandwidth is defined as the total spectrum the power of which is higher than peak power minus 6dB.

### Test Configuration



### Test Results

ANT 1

Type	Channel	6dB Bandwidth (MHz)	Limit (KHz)	Result
802.11b	01	8.000	≥500	Pass
	06	8.480		
	11	8.040		
802.11g	01	16.280	≥500	Pass
	06	16.360		
	11	16.280		
802.11n(HT20)	01	16.680	≥500	Pass
	06	16.920		
	11	16.760		

ANT 2

Type	Channel	6dB Bandwidth (MHz)	Limit (KHz)	Result
802.11b	01	10.080	≥500	Pass
	06	10.120		
	11	10.080		
802.11g	01	15.920	≥500	Pass
	06	15.840		
	11	15.680		
802.11n(HT20)	01	16.240	≥500	Pass
	06	16.080		
	11	16.280		

Note:

- 1) Measured peak power spectrum density at difference data rate for each mode and recorded worst case for each mode.
- 2) Test results including cable loss;
- 3) Worst case data at 1Mbps at IEEE 802.11b; 6Mbps at IEEE 802.11g; 6.5Mbps at IEEE 802.11n HT20;

Please refer to following plots;

ANT 1

802.11b

802.11g

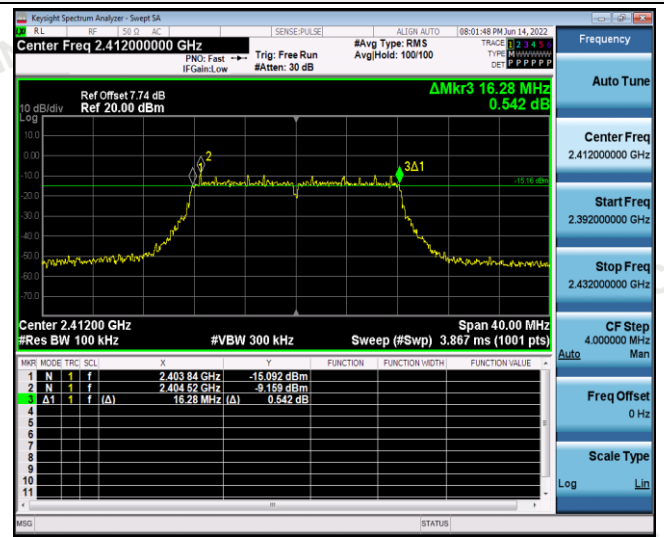
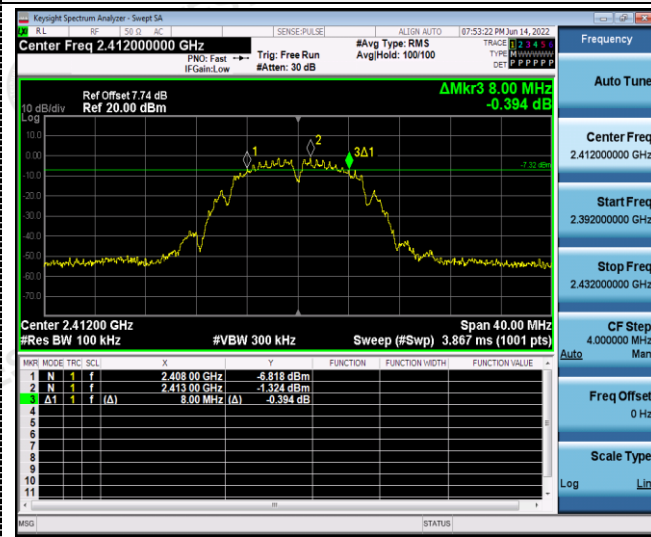

CH01

CH01

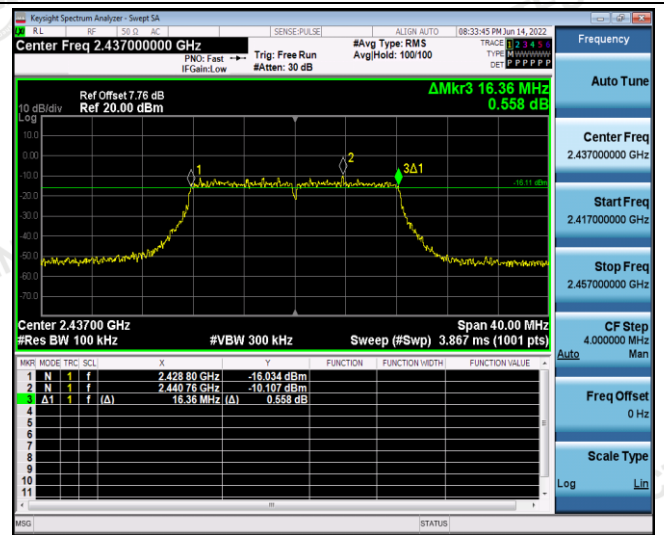

CH06

CH06

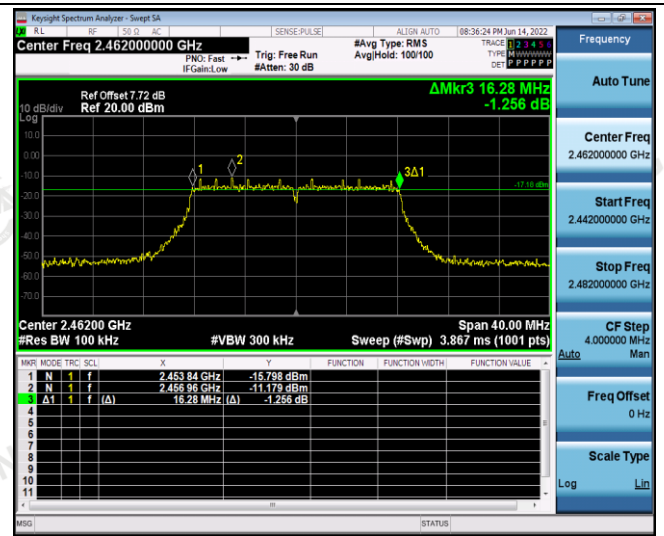

CH11

CH11

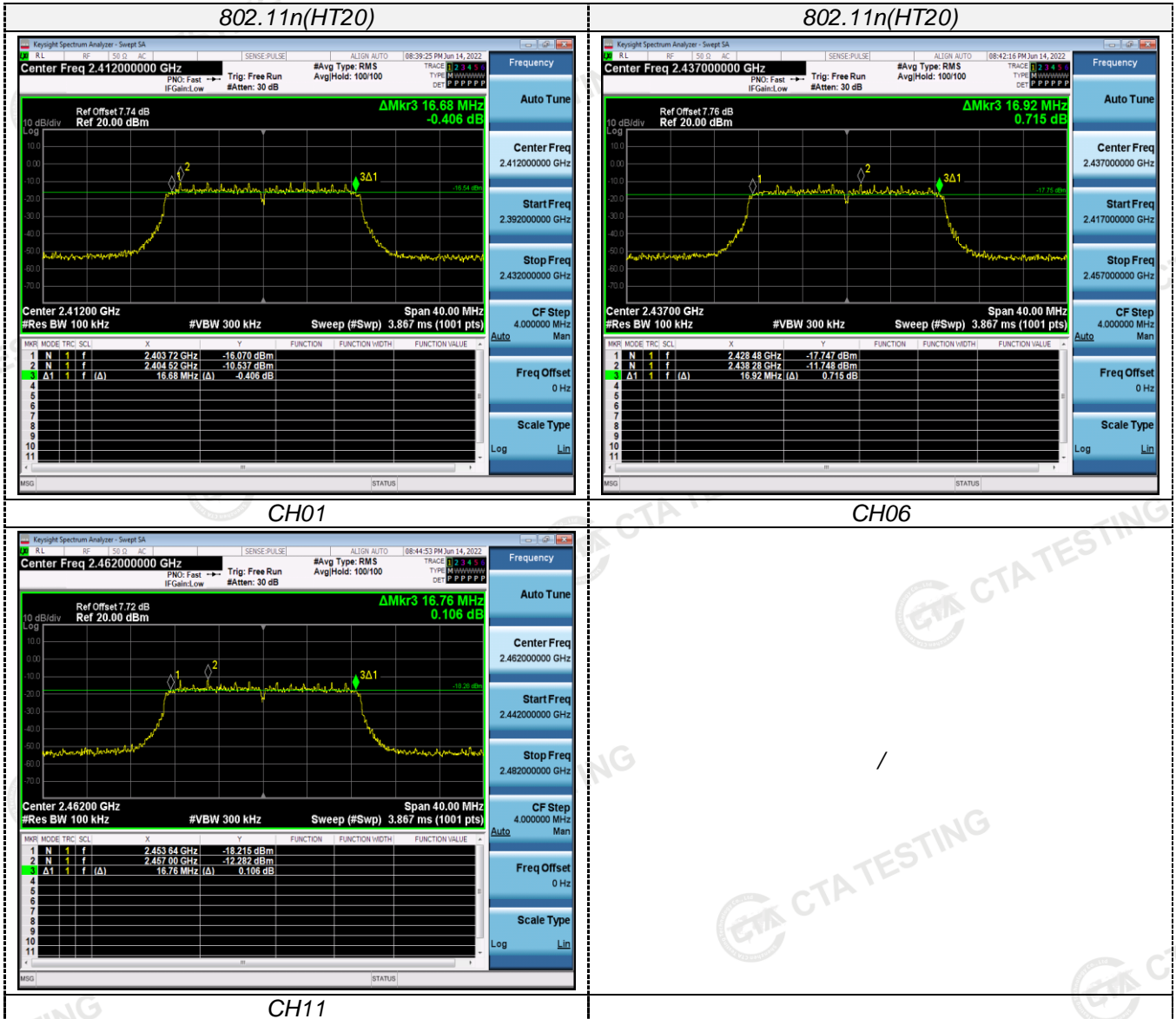

ANT 2

802.11b

802.11g

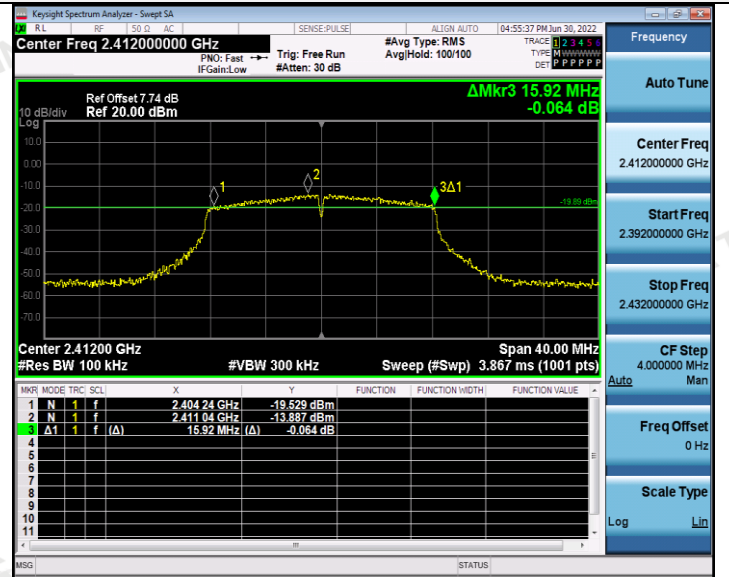
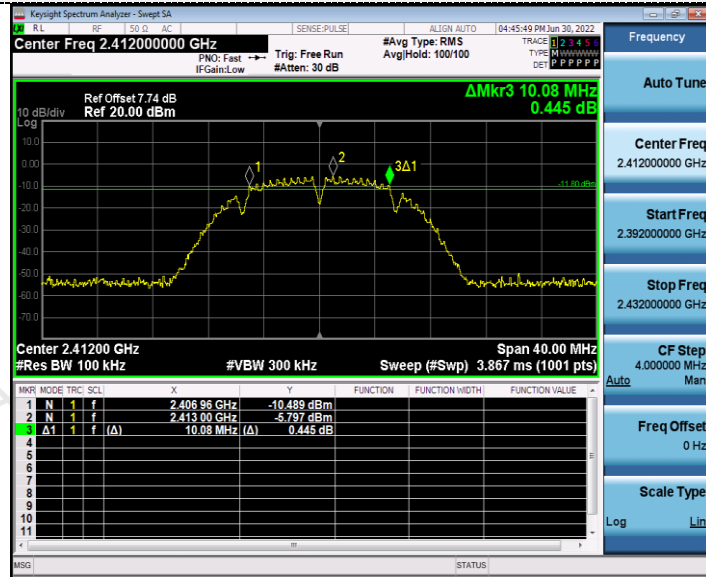

CH01

CH01

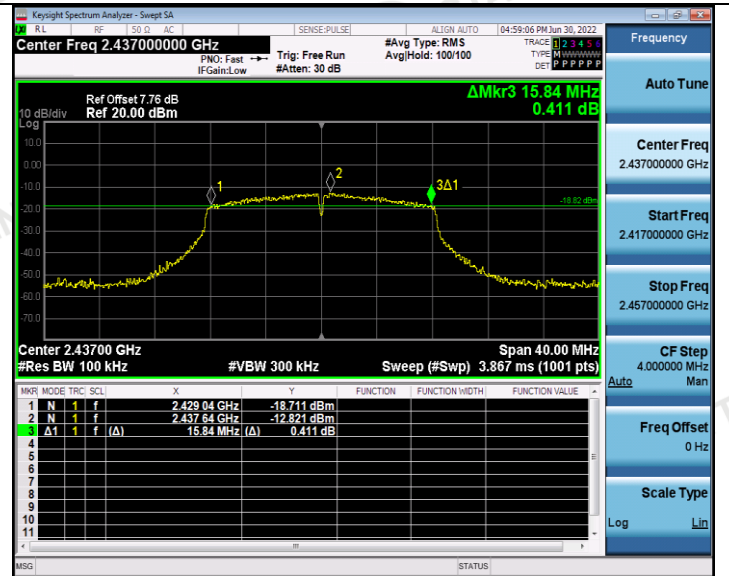

CH06

CH06

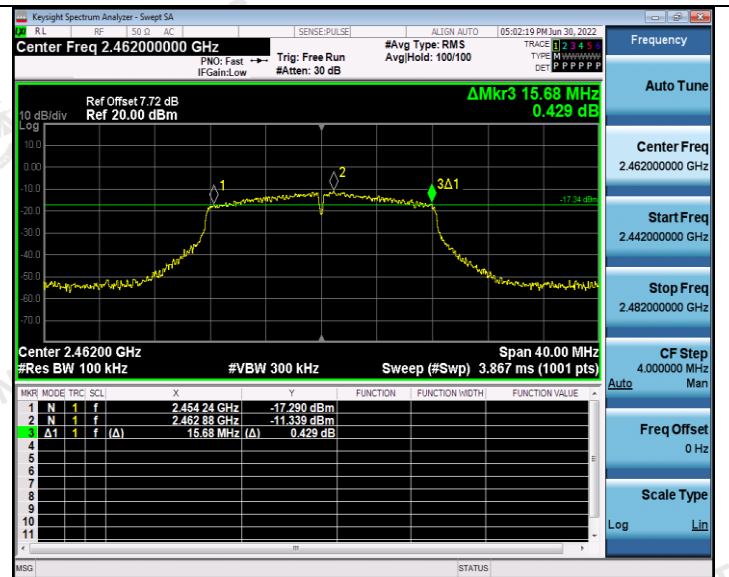
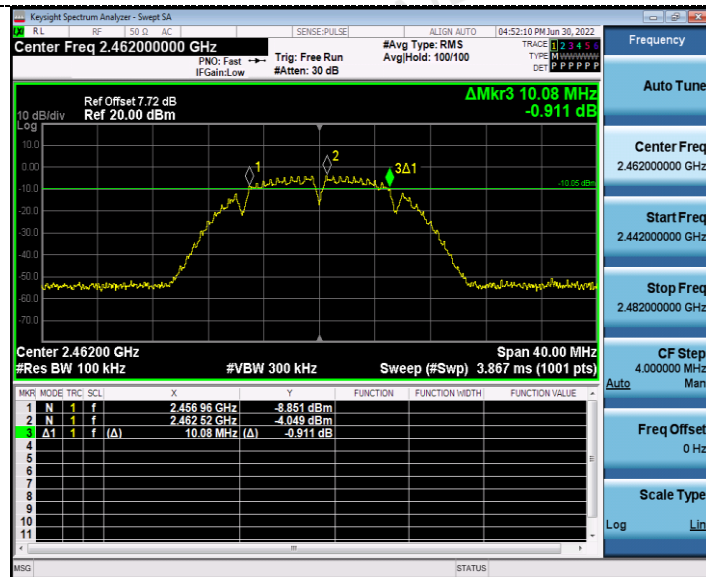

CH11

CH11

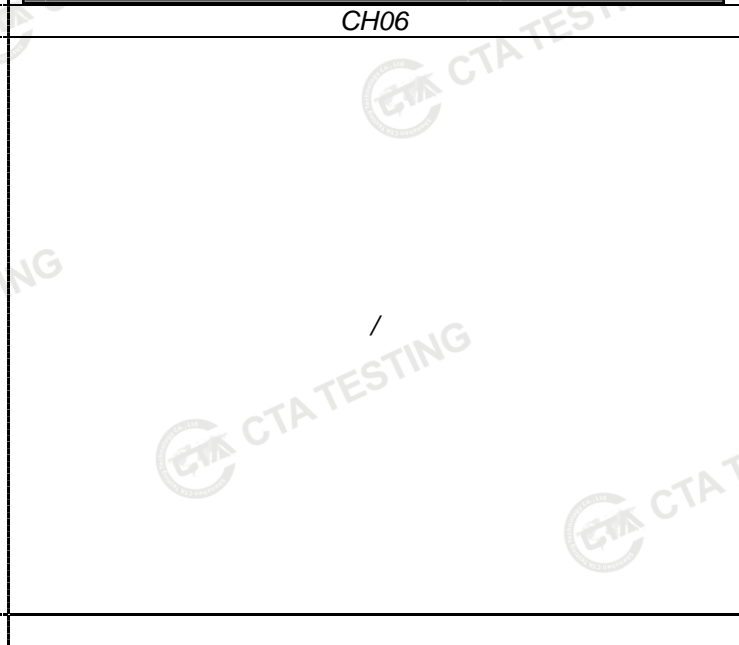
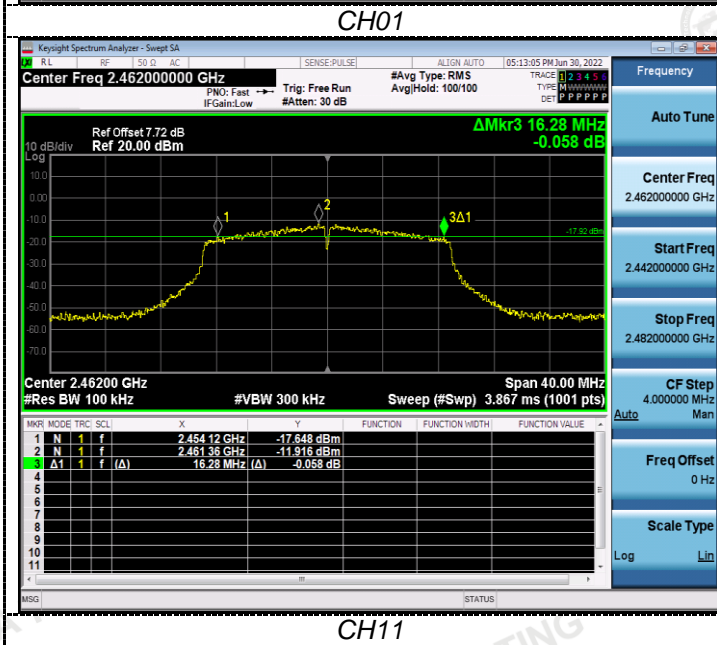
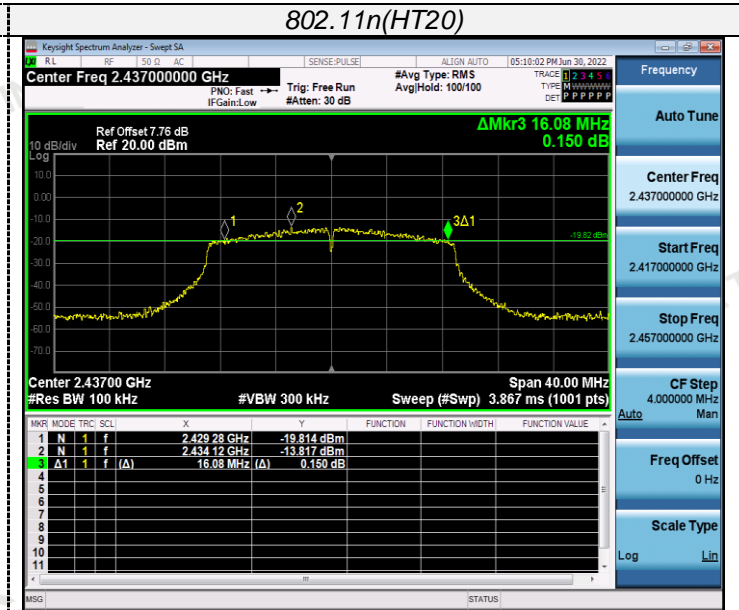
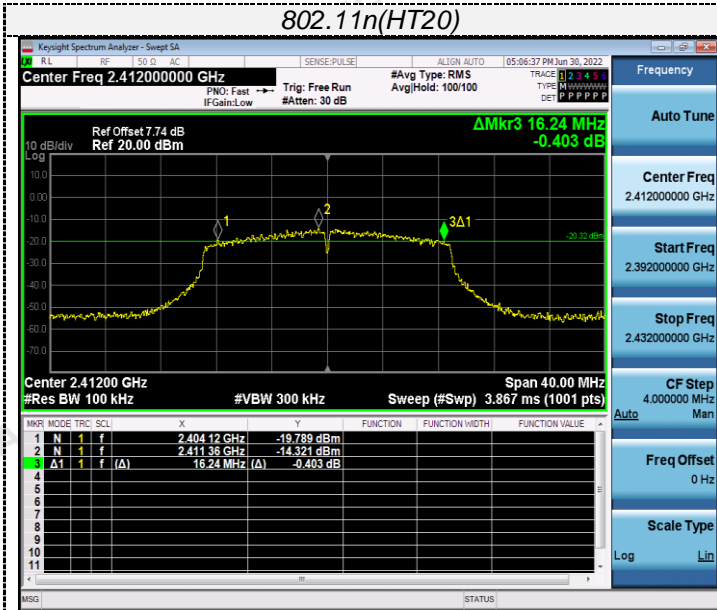

**CH11**



## 4.6 Out-of-band Emissions

### Limit

In any 100 kHz bandwidth outside the frequency band in which the spread spectrum or digitally modulated intentional radiator is operating, the radio frequency power that is produced by the intentional radiator shall be at least 20 dB below that in the 100 kHz bandwidth within the band that contains the highest level of the desired power, based on either an RF conducted or a radiated measurement, provided the transmitter demonstrates compliance with the peak conducted power limits. If the transmitter complies with the conducted power limits based on the use of RMS averaging over a time interval, as permitted under paragraph (b)(3) of this section, the attenuation required under this paragraph shall be 30 dB instead of 20 dB. Attenuation below the general limits specified in §15.209(a) is not required.

### Test Procedure

Connect the transmitter output to spectrum analyzer using a low loss RF cable, and set the spectrum analyzer to RBW=100 kHz, VBW= 300 kHz, peak detector, and max hold. Measurements utilizing these settings are made of the in-band reference level, band edge and out-of-band emissions.

### Test Configuration

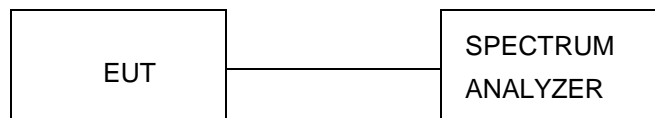

### Test Results

Remark: The measurement frequency range is from 30MHz to the 10th harmonic of the fundamental frequency. The lowest, middle and highest channels are tested to verify the spurious emissions and band edge measurement data. And record the worst data in the report.

Test plot as follows: