



Shenzhen CTA Testing Technology Co., Ltd.

Room 106, Building 1, Yibaolai Industrial Park, Qiaotou Community, Fuhai Street, Bao'an District, Shenzhen, China

TEST REPORT

FCC Part 22 Subpart H / Part 24 Subpart E/ Part 27

Report Reference No.....: CTA23031300206

FCC ID.....: 2A6P9-WCPAA-3

Compiled by

(position+printed name+signature) :: File administrators Kevin Liu

Supervised by

(position+printed name+signature) :: Project Engineer Kevin Liu

Approved by

(position+printed name+signature) :: RF Manager Eric Wang

Date of issue.....: Mar. 30, 2023

Kevin Liu
Eric Wang
Shenzhen CTA Testing Technology Co., Ltd.
approved

Testing Laboratory Name: Shenzhen CTA Testing Technology Co., Ltd.

Address: Room 106, Building 1, Yibaolai Industrial Park, Qiaotou Community, Fuhai Street, Bao'an District, Shenzhen, China

Applicant's name: Promaster Electronic LLC

Address: 25511 Budde Rd, Suite 1602, The Woodlands, Texas, 77380. USA

Test specification

Standard: FCC CFR Title 47 Part 2, Part 22H, Part 24E and Part 27
ANSI/TIA-603-E-2016
KDB 971168 D01

Shenzhen CTA Testing Technology Co., Ltd. All rights reserved.

This publication may be reproduced in whole or in part for non-commercial purposes as long as the Shenzhen CTA Testing Technology Co., Ltd. is acknowledged as copyright owner and source of the material. Shenzhen CTA Testing Technology Co., Ltd. takes no responsibility for and will not assume liability for damages resulting from the reader's interpretation of the reproduced material due to its placement and context.

Test item description.....: Wireless CPAA Adapter

Trade Mark: Autosky

Manufacturer: Promaster Electronic LLC

Model/Type reference.....: WCPAA-3

Listed Models: WCPAA-3A, WCPAA-3B

Ratings: DC 5V From external circuit

Modulation: QPSK

Hardware version: V1.0

Software version: V1.0

Frequency.....: UMTS Band II, UMTS Band IV, UMTS Band V

Result.....: PASS

TEST REPORT

Equipment under Test : Wireless CPAA Adapter

Model /Type : WCPAA-3

Listed Models : WCPAA-3A, WCPAA-3B

Applicant : Promaster Electronic LLC

Address : 25511 Budde Rd, Suite 1602, The Woodlands, Texas, 77380.
USA

Manufacturer : Promaster Electronic LLC

Address : 25511 Budde Rd, Suite 1602, The Woodlands, Texas, 77380.
USA

Test result	Pass *
--------------------	---------------

* In the configuration tested, the EUT complied with the standards specified page 4.

The test report merely corresponds to the test sample.

It is not permitted to copy extracts of these test result without the written permission of the test laboratory.

Contents

1	SUMMARY	4
1.1	TEST STANDARDS	4
1.2	TEST DESCRIPTION	4
1.3	ADDRESS OF THE TEST LABORATORY	4
1.4	TEST FACILITY	4
1.5	STATEMENT OF THE MEASUREMENT UNCERTAINTY	5
2	GENERAL INFORMATION	6
2.1	ENVIRONMENTAL CONDITIONS	6
2.2	GENERAL DESCRIPTION OF EUT	6
2.3	DESCRIPTION OF TEST MODES AND TEST FREQUENCY	7
2.4	EQUIPMENTS USED DURING THE TEST	8
2.5	RELATED SUBMITTAL(S) / GRANT (S)	8
2.6	MODIFICATIONS	8
3	TEST CONDITIONS AND RESULTS	9
3.1	OUTPUT POWER	9
3.2	OCCUPIED BANDWIDTH	13
3.3	BAND EDGE COMPLIANCE	16
3.4	SPURIOUS EMISSION	18
3.5	PEAK-TO-AVERAGE RATIO (PAR)	28
3.6	FREQUENCY STABILITY UNDER TEMPERATURE & VOLTAGE VARIATIONS	32
4	TEST SETUP PHOTOS OF THE EUT	34
5	EXTERNAL AND INTERNAL PHOTOS OF THE EUT.....	35

1 SUMMARY

1.1 TEST STANDARDS

The tests were performed according to following standards:

[FCC Part 2](#): FREQUENCY ALLOCATIONS AND RADIO TREATY MATTERS; GENERAL RULES AND REGULATIONS

[FCC Part 22 Subpart H](#): PRIVATE LAND MOBILE RADIO SERVICES.

[FCC Part 24 Subpart E](#): PUBLIC MOBILE SERVICES

[FCC Part 27](#): MISCELLANEOUS WIRELESS COMMUNICATIONS SERVICES

[ANSI/TIA-603-E-2016](#): Land Mobile FM or PM Communications Equipment Measurement and Performance Standards.

[ANSI C63.10-2013](#) Methods of Measurement of Radio-Noise Emissions from Low-Voltage Electrical and Electronic Equipment in the Range of 9 kHz to 40 GHz

[FCCKDB971168D01](#) Power Meas License Digital Systems

1.2 Test Description

Test Item	Section in CFR 47	Result
RF Output Power	Part 2.1046 Part 22.913 (a)(2) Part 24.232 (c) Part 27.50(d)	Pass
Peak-to-Average Ratio	Part 24.232 (d) Part 27.50(d)	Pass
99% & -26 dB Occupied Bandwidth	Part 2.1049 Part 22.917 Part 24.238	Pass
Spurious Emissions at Antenna Terminal	Part 2.1051 Part 22.917 (a) Part 24.238 (a) Part 27.53(h)	Pass
Field Strength of Spurious Radiation	Part 2.1053 Part 22.917 (a) Part 24.238 (a) Part 27.53(h)	Pass
Out of band emission, Band Edge	Part 22.917 (a) Part 24.238 (a) Part 27.53(h)	Pass
Frequency stability	Part 2.1055 Part 22.355 Part 24.235 Part 27.54	Pass

1.3 Address of the test laboratory

Shenzhen CTA Testing Technology Co., Ltd.

Room 106, Building 1, Yibaolai Industrial Park, Qiaotou Community, Fuhai Street, Bao'an District, Shenzhen, China

The 3m-Semi anechoic test site fulfils CISPR 16-1-4 according to ANSI C63.4:2014 and CISPR 16-1-4:2010 SVSWR requirement for radiated emission above 1GHz.

1.4 Test Facility

The test facility is recognized, certified, or accredited by the following organizations:

FCC-Registration No.: 517856 Designation Number: CN1318

Shenzhen CTA Testing Technology Co., Ltd. has been listed on the US Federal Communications Commission list of test facilities recognized to perform electromagnetic emissions measurements.

Industry Canada Registration Number. Is: 27890 CAB identifier: CN0127

The Laboratory has been registered by Certification and Engineering Bureau of Industry Canada for radio equipment testing.

A2LA-Lab Cert. No.: 6534.01

Shenzhen CTA Testing Technology Co., Ltd. has been listed by American Association for Laboratory Accreditation to perform electromagnetic emission measurement.

The 3m-Semi anechoic test site fulfils CISPR 16-1-4 according to ANSI C63.10 and CISPR 16-1-4:2010.

1.5 Statement of the measurement uncertainty

The data and results referenced in this document are true and accurate. The reader is cautioned that there may be errors within the calibration limits of the equipment and facilities. The measurement uncertainty was calculated for all measurements listed in this test report acc. to TR-100028-01 "Electromagnetic compatibility and Radio spectrum Matters (ERM); Uncertainties in the measurement of mobile radio equipment characteristics; Part 1" and TR-100028-02 "Electromagnetic compatibility and Radio spectrum Matters (ERM); Uncertainties in the measurement of mobile radio equipment characteristics; Part 2" and is documented in the Shenzhen CTA Testing Technology Co., Ltd. quality system acc. to DIN EN ISO/IEC 17025. Furthermore, component and process variability of devices similar to that tested may result in additional deviation. The manufacturer has the sole responsibility of continued compliance of the device.

Hereafter the best measurement capability for Shenzhen CTA Testing Technology Co., Ltd. is reported:

Test	Range	Measurement Uncertainty	Notes
Radiated Emission	30~1000MHz	4.10 dB	(1)
Radiated Emission	1~18GHz	4.32 dB	(1)
Radiated Emission	18-40GHz	5.54 dB	(1)
Conducted Disturbance	0.15~30MHz	3.12 dB	(1)
Conducted Power	9KHz~18GHz	0.61 dB	(1)
Spurious RF Conducted Emission	9KHz~40GHz	1.22 dB	(1)
Band Edge Compliance of RF Emission	9KHz~40GHz	1.22 dB	(1)
Occupied Bandwidth	9KHz~40GHz	-	(1)

- (1) This uncertainty represents an expanded uncertainty expressed at approximately the 95% confidence level using a coverage factor of $k=1.96$.

2 GENERAL INFORMATION

2.1 Environmental conditions

Date of receipt of test sample	:	Mar. 13, 2023
Testing commenced on	:	Mar. 13, 2023
Testing concluded on	:	Mar. 30, 2023

During the measurement the environmental conditions were within the listed ranges:

Normal Temperature:	25°C
Relative Humidity:	55 %
Air Pressure:	101 kPa

2.2 General Description of EUT

Product Name:	Wireless CPAA Adapter
Model/Type reference:	WCPAA-3
Power supply:	DC 5V From external circuit
Adapter information (Auxiliary test supplied by test Lab :	Model: EP-TA20CBC Input: AC 100-240V 50/60Hz Output: DC 5V 2A
Testing sample ID :	CTA230313002-1# (Engineer sample) CTA230313002-2# (Normal sample)
WCDMA	
Operation Band:	FDD Band II & Band IV & Band V
Power Class:	Power Class 3
Modulation Type:	QPSK for WCDMA/HSUPA/HSDPA, 16QAM for HSPA+
Release Version:	R8
Antenna type:	PIFA Antenna
Antenna gain:	FDD Band II: 1dBi FDD Band IV: 1dBi FDD Band V: 1dBi

Note: For more details, refer to the user's manual of the EUT.

2.3 Description of Test Modes and Test Frequency

The EUT has been tested under typical operating condition. The CUM200 used to control the EUT staying in continuous transmitting and receiving mode for testing. Regards to the frequency band operation : the lowest, middle and highest frequency of channel were selected to perform the test, then shown on this report.

Test Frequency:

FDD Band II		FDD Band IV		FDD Band V	
Channel	Frequency (MHz)	Channel	Frequency (MHz)	Channel	Frequency (MHz)
9262	1852.4	1312	1712.4	4132	826.40
9400	1880.0	1413	1732.6	4182	836.60
9538	1907.6	1513	1752.6	4233	846.60

Test Modes:

The test mode(s) are selected according to relevant radio technology specifications.

Test Mode	Test Modes Description
Mode 1	WCDMA system, QPSK modulation
Mode 2	HSDPA system, QPSK modulation
Mode 3	HSUPA system, QPSK modulation

Note:

- As HSDPA and HSUPA with the same emission designator, test result recorded in this report at the worst case Mode 4 with RCM 12.2Kbps only after exploratory scan.

2.4 Equipments Used during the Test

Test Equipment	Manufacturer	Model No.	Equipment No.	Calibration Date	Calibration Due Date
LISN	R&S	ENV216	CTA-308	2022/08/03	2023/08/02
LISN	R&S	ENV216	CTA-314	2022/08/03	2023/08/02
EMI Test Receiver	R&S	ESPI	CTA-307	2022/08/03	2023/08/02
EMI Test Receiver	R&S	ESCI	CTA-306	2022/08/03	2023/08/02
Spectrum Analyzer	Agilent	N9020A	CTA-301	2022/08/03	2023/08/02
Spectrum Analyzer	R&S	FSP	CTA-337	2022/08/03	2023/08/02
Vector Signal generator	Agilent	N5182A	CTA-305	2022/08/03	2023/08/02
Analog Signal Generator	R&S	SML03	CTA-304	2022/08/03	2023/08/02
Universal Radio Communication	CMW500	R&S	CTA-302	2022/08/03	2023/08/02
Temperature and humidity meter	Chigo	ZG-7020	CTA-326	2022/08/03	2023/08/02
Ultra-Broadband Antenna	Schwarzbeck	VULB9163	CTA-310	2021/08/07	2024/08/06
Horn Antenna	Schwarzbeck	BBHA 9120D	CTA-309	2021/08/07	2024/08/06
Loop Antenna	Zhinan	ZN30900C	CTA-311	2021/08/07	2024/08/06
Horn Antenna	Beijing Hangwei Dayang	OBH100400	CTA-336	2021/08/07	2024/08/06
Amplifier	Schwarzbeck	BBV 9745	CTA-312	2022/08/03	2023/08/02
Amplifier	Taiwan chengyi	EMC051845B	CTA-313	2022/08/03	2023/08/02
Directional coupler	NARDA	4226-10	CTA-303	2022/08/03	2023/08/02
High-Pass Filter	XingBo	XBLBQ-GTA18	CTA-402	2022/08/03	2023/08/02
High-Pass Filter	XingBo	XBLBQ-GTA27	CTA-403	2022/08/03	2023/08/02
Automated filter bank	Tonscend	JS0806-F	CTA-404	2022/08/03	2023/08/02
Power Sensor	Agilent	U2021XA	CTA-405	2022/08/03	2023/08/02
Amplifier	Schwarzbeck	BBV9719	CTA-406	2022/08/03	2023/08/02

2.5 Related Submittal(s) / Grant (s)

This submittal(s) (test report) is intended for FCC ID: **2A6P9-WCPAA-3** filing to comply with of the FCC Part 22 and Part 24 Rules.

2.6 Modifications

No modifications were implemented to meet testing criteria.

3 TEST CONDITIONS AND RESULTS

3.1 Output Power

LIMIT

GSM850/WCDMA Band V: 7W

PCS1900/WCDMA Band II: 2W

WCDMA Band IV: 1W

The Peak-to-Average Ratio (PAR) of the transmission may not exceed 13 Db.

TEST CONFIGURATION

Conducted Power Measurement

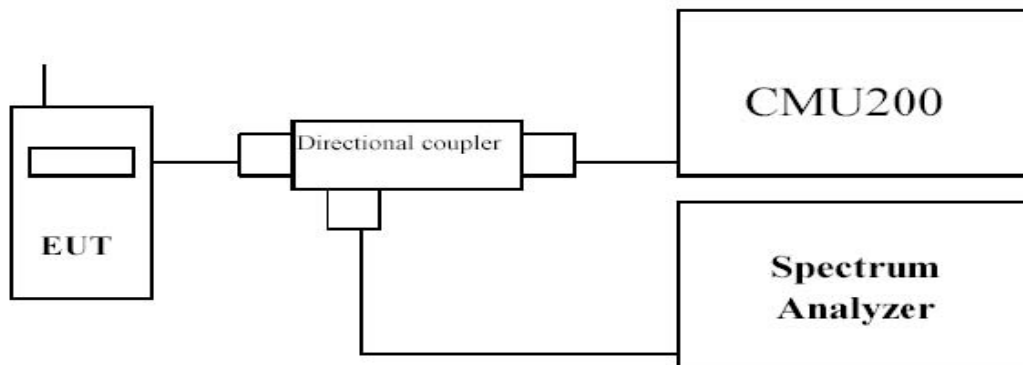

Radiated Power Measurement:

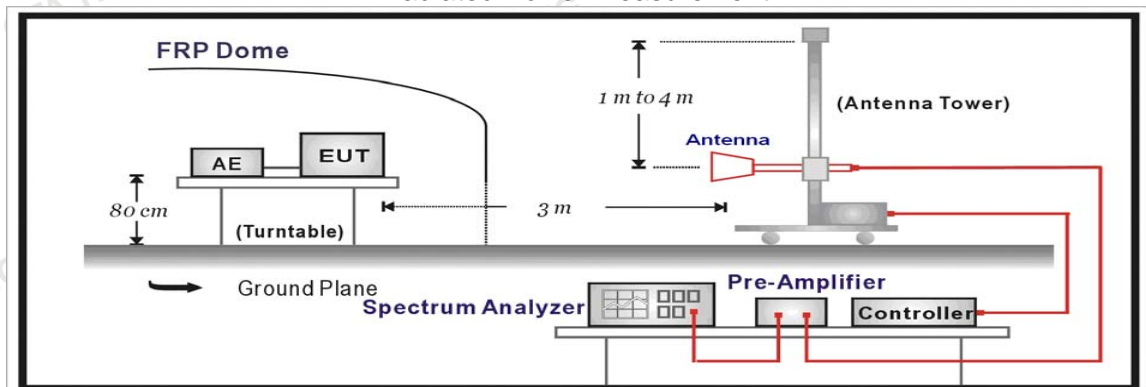

TEST PROCEDURE

The EUT was setup according to EIA/TIA 603C

Conducted Power Measurement:

- Place the EUT on a bench and set it in transmitting mode.
- Connect a low loss RF cable from the antenna port to a spectrum analyzer and CMU200 by a Directional Coupler.
- EUT Communicate with CMU200 then selects a channel for testing.
- Add a correction factor to the display of spectrum, and then test.

Radiated Power Measurement:

- The EUT shall be placed at the specified height on a support, and in the position closest to normal use as declared by provider.
- The test antenna shall be oriented initially for vertical polarization and shall be chosen to correspond to the frequency of the transmitter
- The output of the test antenna shall be connected to the measuring receiver.

- d) The transmitter shall be switched on and the measuring receiver shall be tuned to the frequency of the transmitter under test.
- e) The test antenna shall be raised and lowered through the specified range of height until a maximum signal level is detected by the measuring receiver.
- f) The transmitter shall then be rotated through 360° in the horizontal plane, until the maximum signal level is detected by the measuring receiver.
- g) The test antenna shall be raised and lowered again through the specified range of height until a maximum signal level is detected by the measuring receiver.
- h) The maximum signal level detected by the measuring receiver shall be noted.
- i) The transmitter shall be replaced by a substitution antenna.
- j) The substitution antenna shall be orientated for vertical polarization and the length of the substitution antenna shall be adjusted to correspond to the frequency of the transmitter.
- k) The substitution antenna shall be connected to a calibrated signal generator.
- l) If necessary, the input attenuator setting of the measuring receiver shall be adjusted in order to increase the sensitivity of the measuring receiver.
- m) The test antenna shall be raised and lowered through the specified range of height to ensure that the maximum signal is received.
- n) The input signal to the substitution antenna shall be adjusted to the level that produces a level detected by the measuring receiver, that is equal to the level noted while the transmitter radiated power was measured, corrected for the change of input attenuator setting of the measuring receiver.
- o) The measurement shall be repeated with the test antenna and the substitution antenna orientated for horizontal polarization.
- p) The measure of the effective radiated power is the larger of the two levels recorded at the input to the substitution antenna, corrected for gain of the substitution antenna if necessary.

TEST RESULTS

Conducted Measurement:

Item	Band	FDD Band II result (dBm)		
		Test Channel		
		ARFCN	9262	9400
AMR	12.2kbps AMR	23.59	23.67	23.54
RMC	12.2kbps RMC	23.49	23.49	23.43
HSDPA	Sub – Test 1	22.93	22.96	22.96
	Sub – Test 2	22.83	22.89	22.88
	Sub – Test 3	22.82	22.81	22.78
	Sub – Test 4	22.80	22.78	22.71
HSUPA	Sub – Test 1	22.80	22.80	22.72
	Sub – Test 2	22.83	22.87	22.88
	Sub – Test 3	22.79	22.75	22.77
	Sub – Test 4	22.83	22.83	22.82
	Sub – Test 5	22.83	22.78	22.77
HSPA+	/	21.76	21.73	21.77

Item	Band	FDD Band IV result (dBm)		
		Test Channel		
		ARFCN	1312	1412
AMR	12.2kbps AMR	23.59	23.56	23.61
RMC	12.2kbps RMC	23.48	23.42	23.55
HSDPA	Sub - Test 1	22.96	22.98	22.90
	Sub - Test 2	22.88	22.86	22.89
	Sub - Test 3	22.77	22.78	22.82
	Sub - Test 4	22.71	22.77	22.78
HSUPA	Sub - Test 1	22.73	22.77	22.76
	Sub - Test 2	22.87	22.81	22.83
	Sub - Test 3	22.71	22.81	22.82
	Sub - Test 4	22.84	22.88	22.85
	Sub - Test 5	22.75	22.75	22.73
HSPA+	/	21.84	21.78	21.73

Item	Band	FDD Band V result (dBm)		
		Test Channel		
		ARFCN	4132	4183
AMR	12.2kbps AMR	23.72	23.71	23.64
RMC	12.2kbps RMC	23.54	23.55	23.46
HSDPA	Sub - Test 1	22.93	22.95	22.96
	Sub - Test 2	22.82	22.86	22.82
	Sub - Test 3	22.81	22.76	22.73
	Sub - Test 4	22.80	22.78	22.71
HSUPA	Sub - Test 1	22.83	22.72	22.77
	Sub - Test 2	22.86	22.81	22.85
	Sub - Test 3	22.78	22.79	22.81
	Sub - Test 4	22.80	22.85	22.86
	Sub - Test 5	22.72	22.77	22.78
HSPA+	/	21.77	21.70	21.74

Radiated Measurement:

Note: 1. The field strength of radiation emission was measured in the following position: EUT stand-up position (Zaxis), lie-down position (X, Y axis). The data show in this report only with the worst case setup. After exploratory measurement the worst case of Z axis was reported.

Note: 2. We test the H direction and V direction and V direction is worse.

WCDMA BAND II

Channel	P _{Mea} (dBm)	P _{cl} (dB)	G _a Antenna Gain(dB)	P _{Ag} (dB)	EIRP (dBm)	Limit (dBm)	Margin (dB)	Polarization
9262	-11.95	3.41	10.24	33.6	28.48	33.01	-4.53	V
9400	-12.05	3.49	10.24	33.6	28.30	33.01	-4.71	V
9538	-12.01	3.55	10.23	33.6	28.27	33.01	-4.74	V

WCDMA BAND IV

Channel	P _{Mea} (dBm)	P _{cl} (dB)	G _a Antenna Gain(dB)	P _{Ag} (dB)	EIRP (dBm)	Limit (dBm)	Margin (dB)	Polarization
1312	-18.09	3.15	9.58	33.6	21.94	30.00	-8.06	V
1413	-16.96	3.17	9.62	33.6	23.09	30.00	-6.91	V
1513	-16.91	3.26	9.71	33.6	23.14	30.00	-6.86	V

WCDMA BAND V

Channel	P _{Mea} (dBm)	P _{cl} (dB)	G _a Antenna Gain(dB)	Correction (dB)	P _{Ag} (dB)	ERP (dBm)	Limit (dBm)	Margin (dB)	Polarization
4132	-11.98	2.42	8.45	2.15	36.82	28.72	38.45	-9.73	V
4183	-11.94	2.46	8.45	2.15	36.82	28.72	38.45	-9.73	V
4233	-11.93	2.53	8.36	2.15	36.82	28.57	38.45	-9.88	V

Remark:

- $EIRP = P_{Mea}(dBm) - P_{cl}(dB) + P_{Ag}(dB) + G_a(dBi)$
- $ERP = EIRP - 2.15dB$ as EIRP by subtracting the gain of the dipole.

3.2 Occupied Bandwidth

LIMIT

N/A

TEST CONFIGURATION

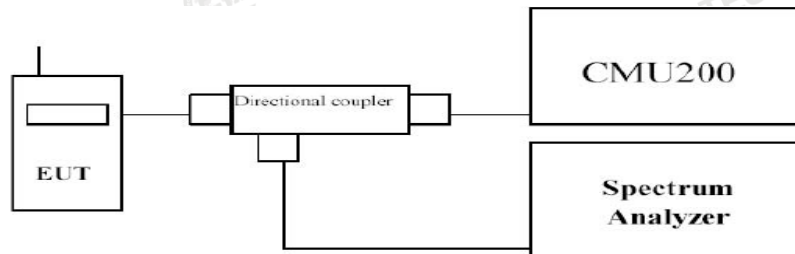

TEST PROCEDURE

1. The EUT's output RF connector was connected with a short cable to the spectrum analyzer
2. RBW was set to about 1% of emission BW, VBW ≥ 3 times RBW.
3. -26dBc display line was placed on the screen (or 99% bandwidth), the occupied bandwidth is the delta frequency between the two points where the display line intersects the signal trace.

TEST RESULTS

EUT Mode	Channel	Frequency (MHz)	99% Occupy bandwidth (MHz)	-26dB bandwidth (KHz)
WCDMA Band II (QPSK)	9262	1852.4	4.1475	4.671
	9400	1880.0	4.1475	4.671
	9538	1907.6	4.1480	4.672
WCDMA Band VI (QPSK)	1312	1712.4	4.1402	4.661
	1413	1732.6	4.1489	4.664
	1513	1752.6	4.1371	4.662
WCDMA Band V (QPSK)	4132	826.4	4.1583	4.692
	4183	836.6	4.1613	4.699
	4233	846.6	4.1553	4.706

Test plots as follow:

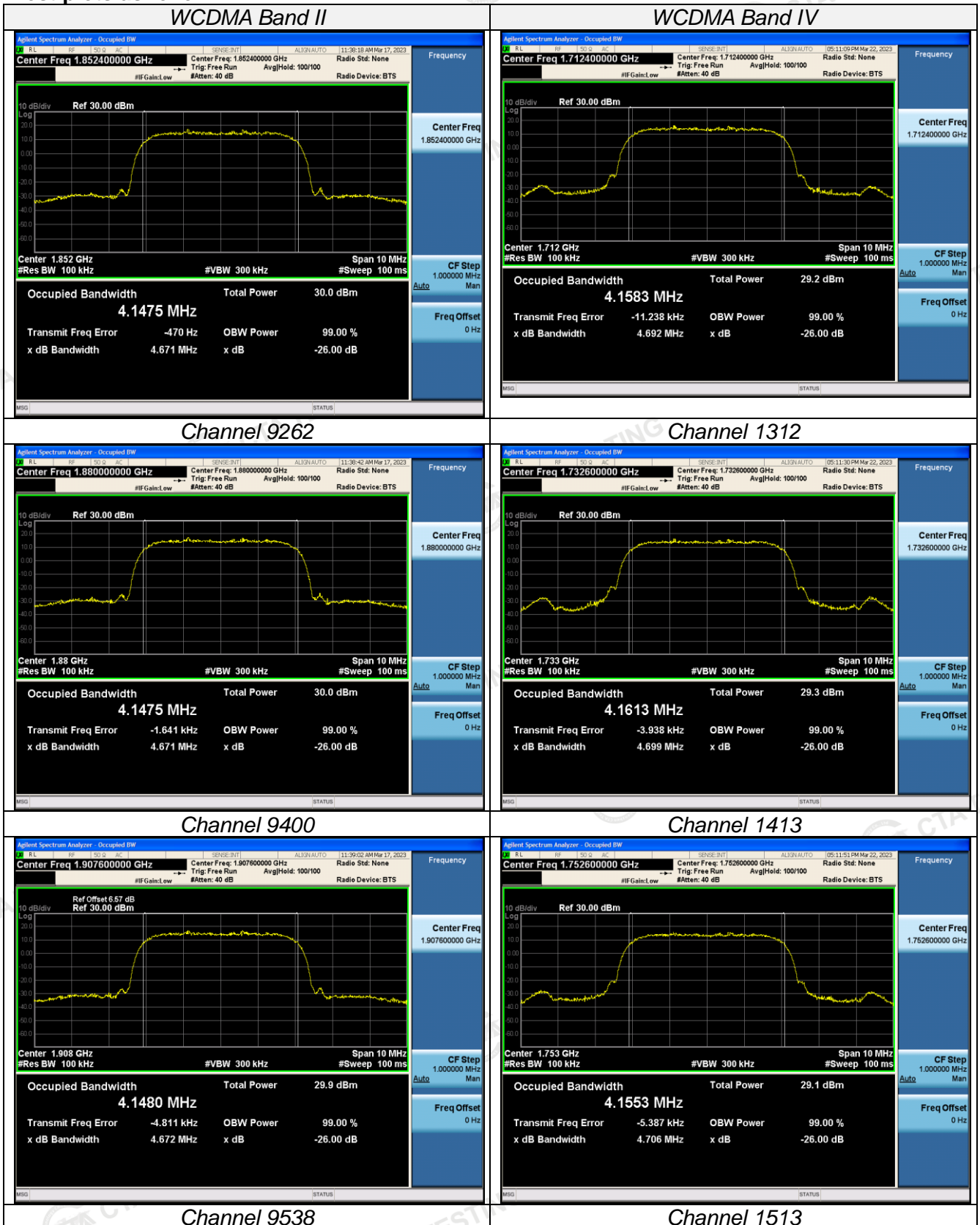

WCDMA Band V

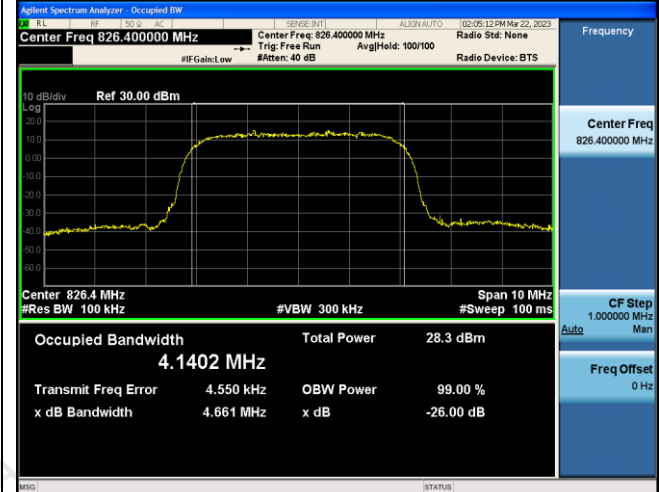

Channel 4132

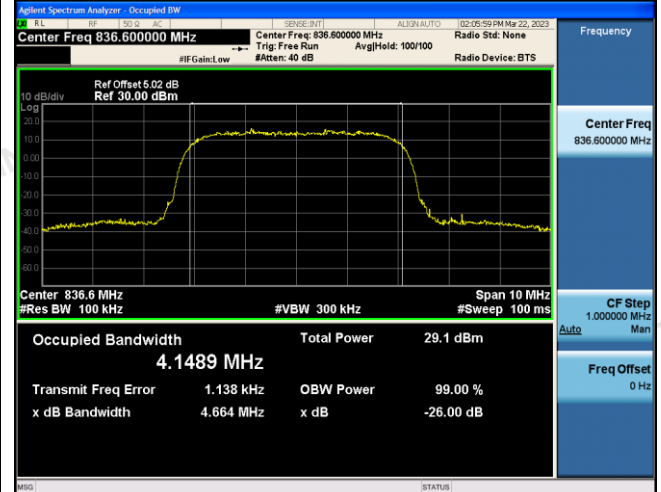

Channel 4183

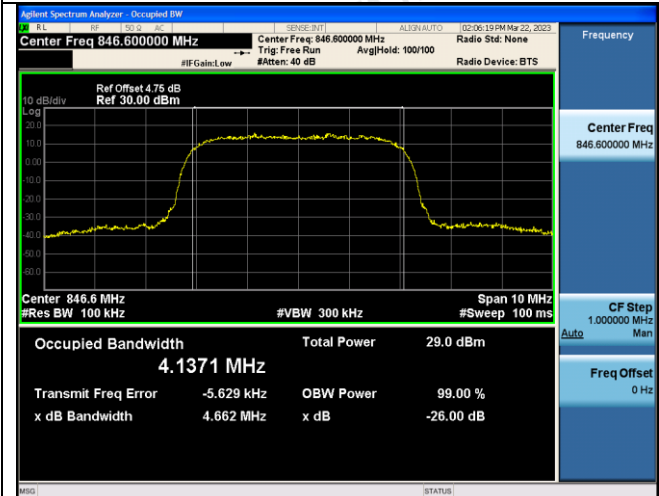

Channel 4233

3.3 Band Edge compliance

LIMIT

The power of any emission outside of the authorized operating frequency ranges must be attenuated below the transmitting power (P) by a factor of at least $43 + 10\log(P)$ dB.

TEST CONFIGURATION

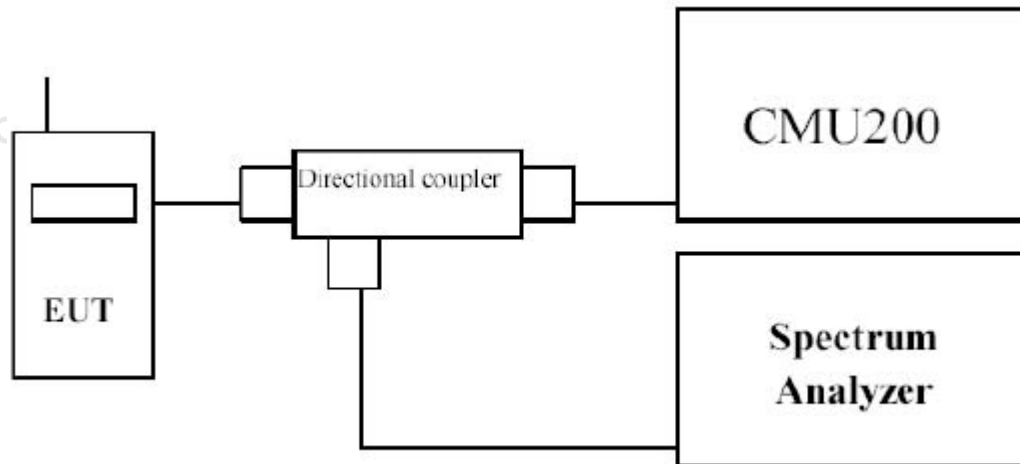

TEST PROCEDURE

In the 1MHz bands immediately outside and adjacent to the frequency block a resolution bandwidth of at least one percent of the emission bandwidth of the fundamental emission of the transmitter may be employed to measure the out of band Emissions.

TEST RESULTS

WCDMA Band II

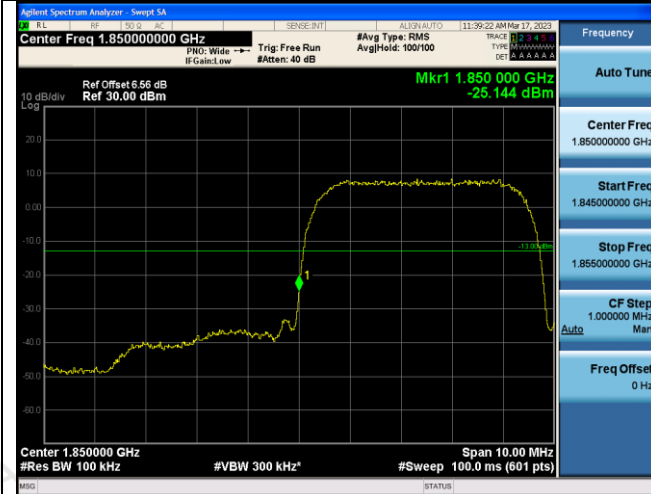

WCDMA Band IV

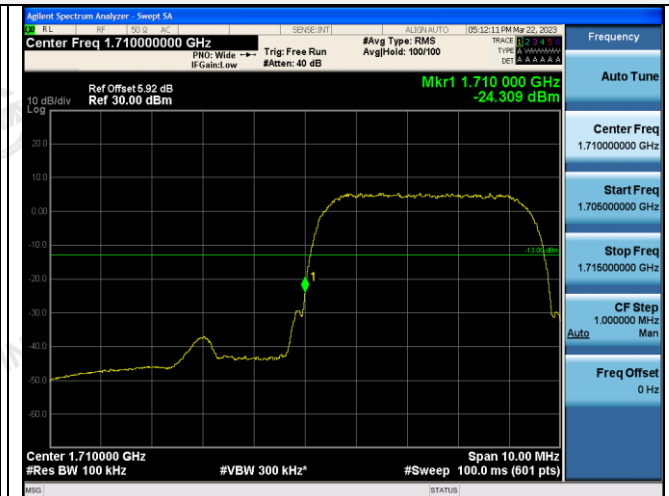
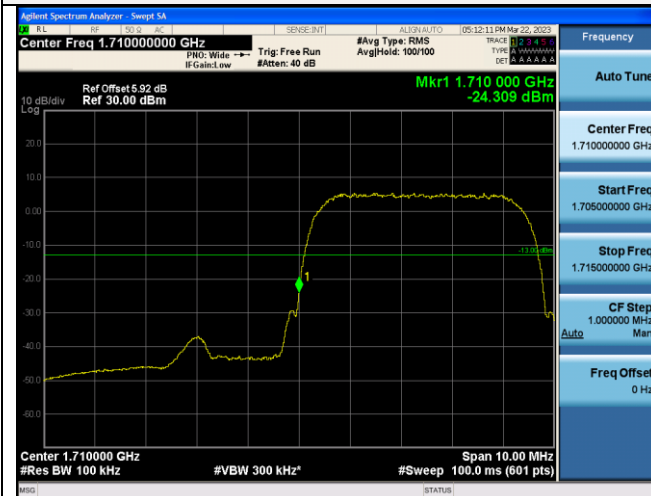

WCDMA Band V

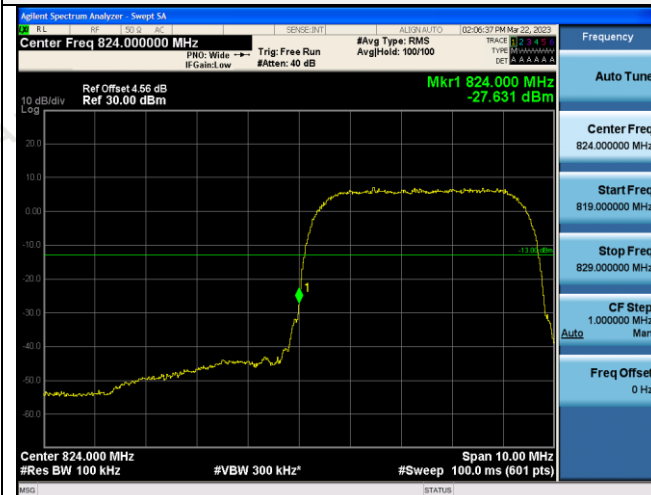

3.4 Spurious Emission

LIMIT

The power of any emission outside of the authorized operating frequency ranges must be attenuated below the transmitting power (P) by a factor of at least $43 + 10\log(P)$ dB.

TEST CONFIGURATION

Conducted Spurious Measurement:

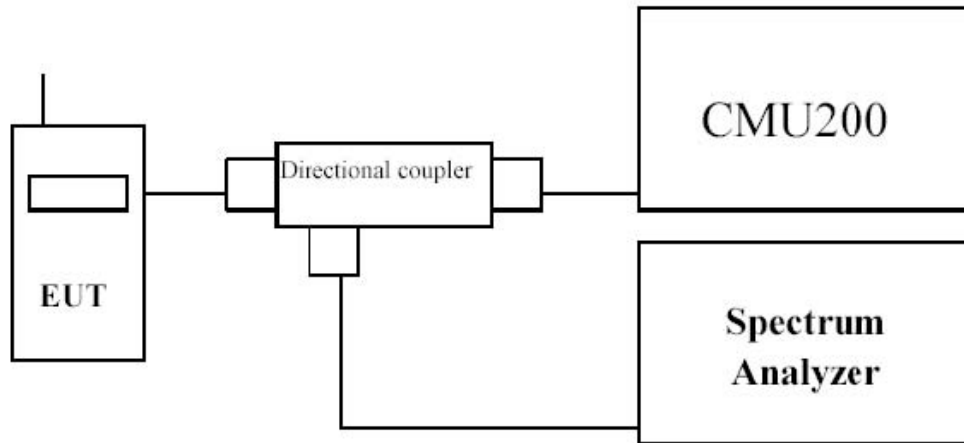

Radiated Spurious Measurement:

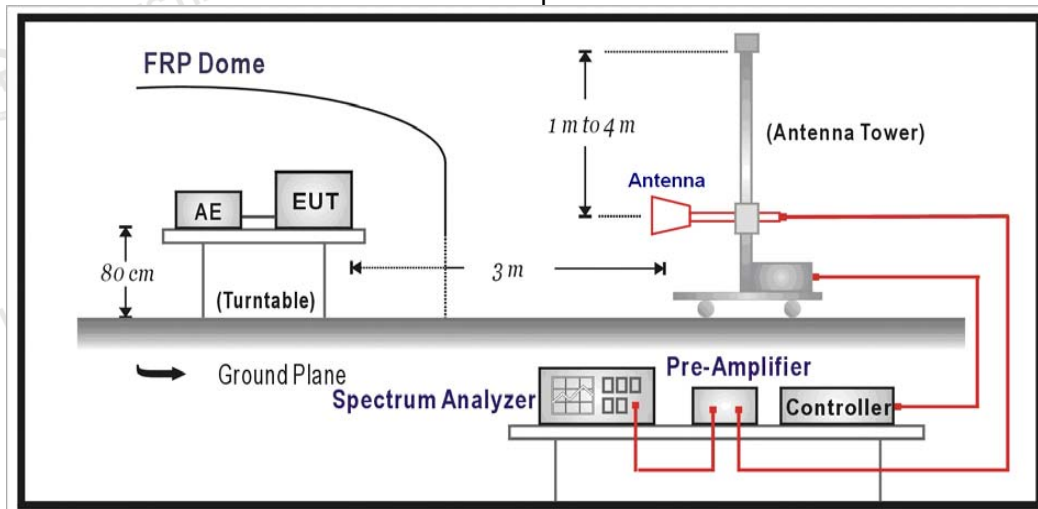

TEST PROCEDURE

The EUT was setup according to EIA/TIA 603C

Conducted Spurious Measurement:

- Place the EUT on a bench and set it in transmitting mode.
- Connect a low loss RF cable from the antenna port to a spectrum analyzer and CMU200 by a Directional Couple.
- EUT Communicate with CMU200 then selects a channel for testing.
- Add a correction factor to the display of spectrum, and then test.
- The resolution bandwidth of the spectrum analyzer was set at 1MHz for Part 22 and 1MHz for Part 24, sufficient scans were taken to show the out of band Emission if any up to 10th harmonic.

Radiated Spurious Measurement:

- a) The EUT shall be placed at the specified height on a support, and in the position closest to normal use as declared by provider.
- b) The test antenna shall be oriented initially for vertical polarization and shall be chosen to correspond to the frequency of the transmitter
- c) The output of the test antenna shall be connected to the measuring receiver.
- d) The transmitter shall be switched on and the measuring receiver shall be tuned to the frequency of the transmitter under test.
- e) The test antenna shall be raised and lowered through the specified range of height until a maximum signal level is detected by the measuring receiver.
- f) The transmitter shall then be rotated through 360° in the horizontal plane, until the maximum signal level is detected by the measuring receiver.
- g) The test antenna shall be raised and lowered again through the specified range of height until a maximum signal level is detected by the measuring receiver.
- h) The maximum signal level detected by the measuring receiver shall be noted.
- i) The transmitter shall be replaced by a substitution antenna.
- j) The substitution antenna shall be orientated for vertical polarization and the length of the substitution antenna shall be adjusted to correspond to the frequency of the transmitter.
- k) The substitution antenna shall be connected to a calibrated signal generator.
- l) If necessary, the input attenuator setting of the measuring receiver shall be adjusted in order to increase the sensitivity of the measuring receiver.
- m) The test antenna shall be raised and lowered through the specified range of height to ensure that the maximum signal is received.
- n) The input signal to the substitution antenna shall be adjusted to the level that produces a level detected by the measuring receiver, that is equal to the level noted while the transmitter radiated power was measured, corrected for the change of input attenuator setting of the measuring receiver.
- o) The measurement shall be repeated with the test antenna and the substitution antenna orientated for horizontal polarization.
- p) The measure of the effective radiated power is the larger of the two levels recorded at the input to the substitution antenna, corrected for gain of the substitution antenna if necessary.
- q) The resolution bandwidth of the spectrum analyzer was set at 100 kHz for Part 22 and 1MHz for Part 24. The frequency range was checked up to 10th harmonic.

TEST RESULTS

Conducted Measurement:

WCDMA Band II



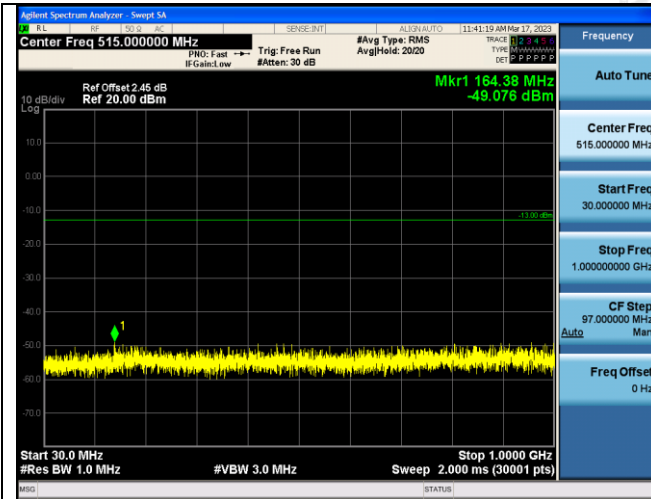

30~1GHz
Channel:

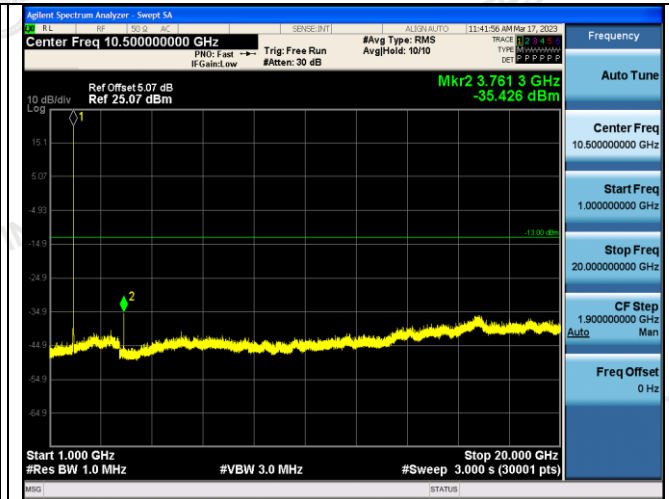

1GHz~20GHz
9538

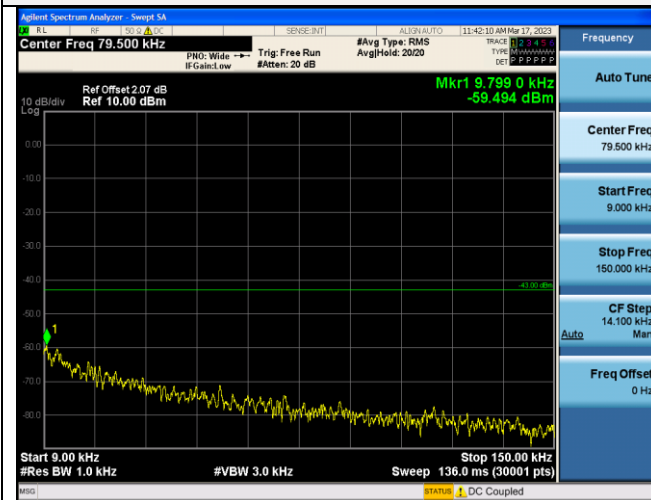

0.009~0.15MHz

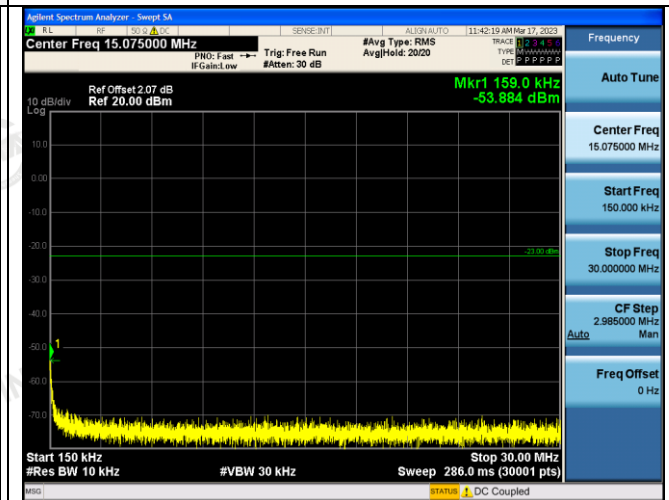

0.15~30MHz

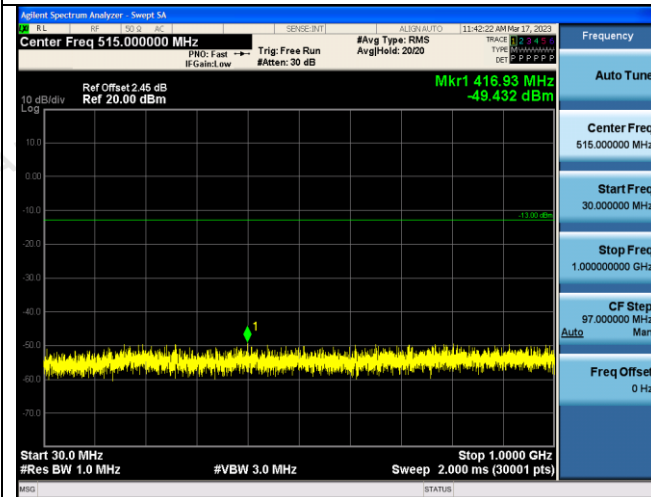

30~1GHz

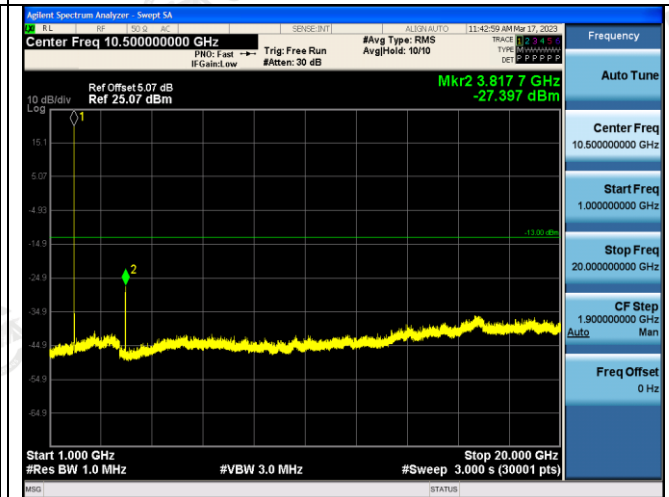

1GHz~20GHz

WCDMA Band IV

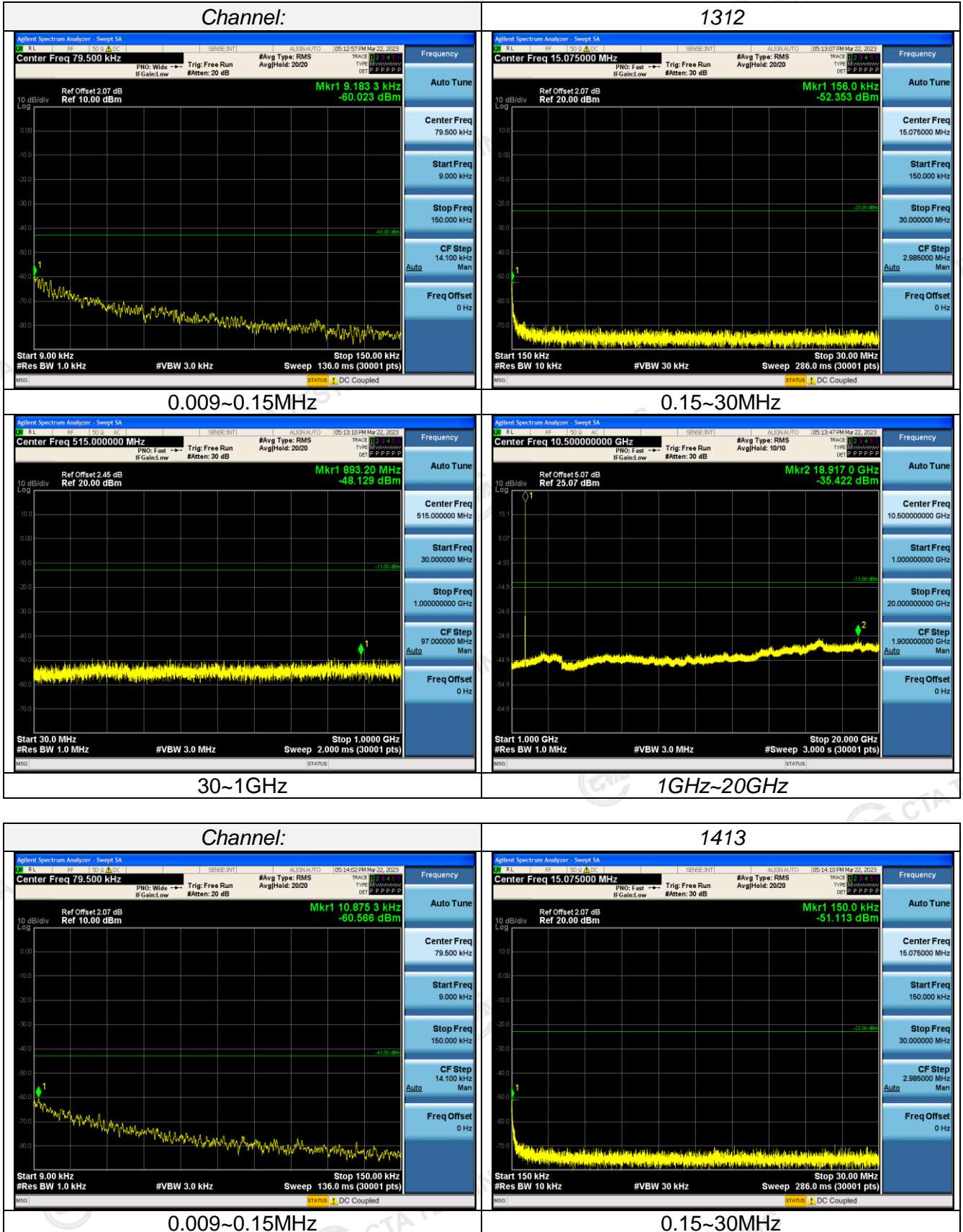

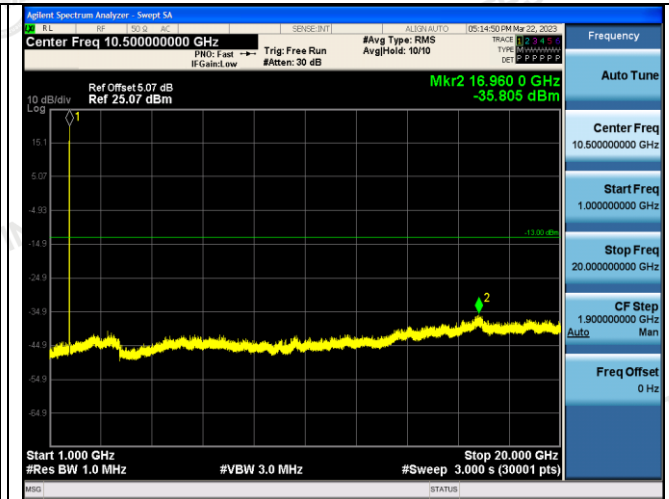
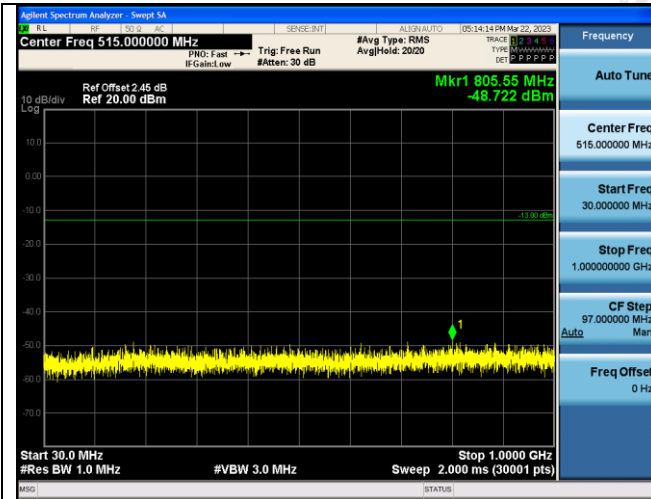

30~1GHz
Channel:

1GHz~20GHz
1513

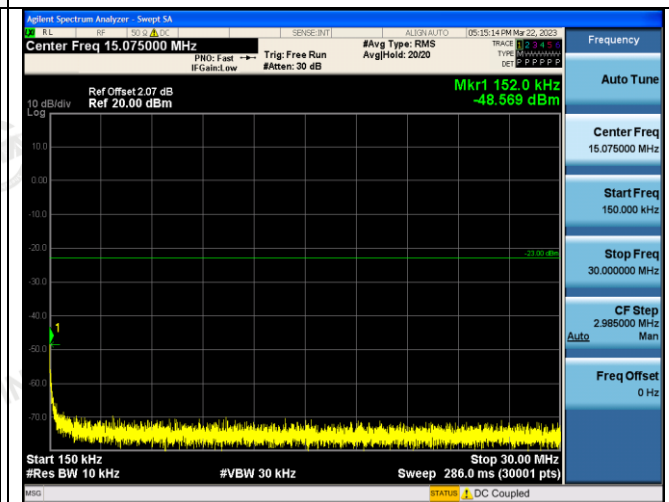
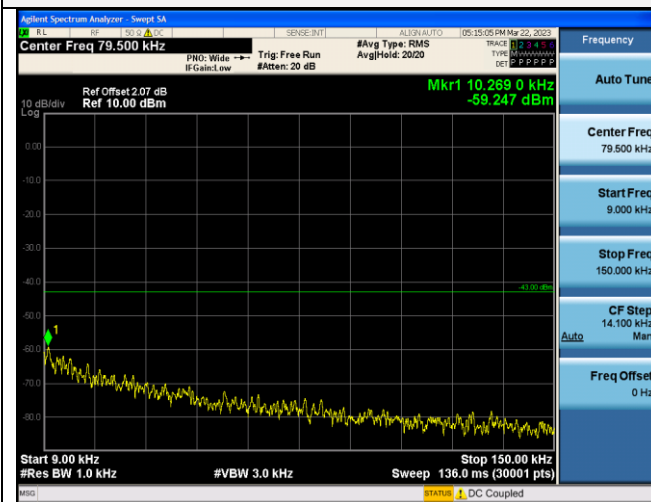

0.009~0.15MHz

0.15~30MHz

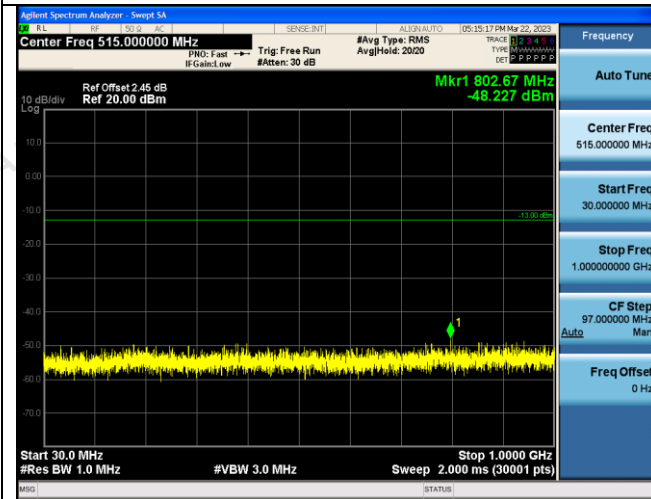

30~1GHz

1GHz~20GHz

WCDMA Band V

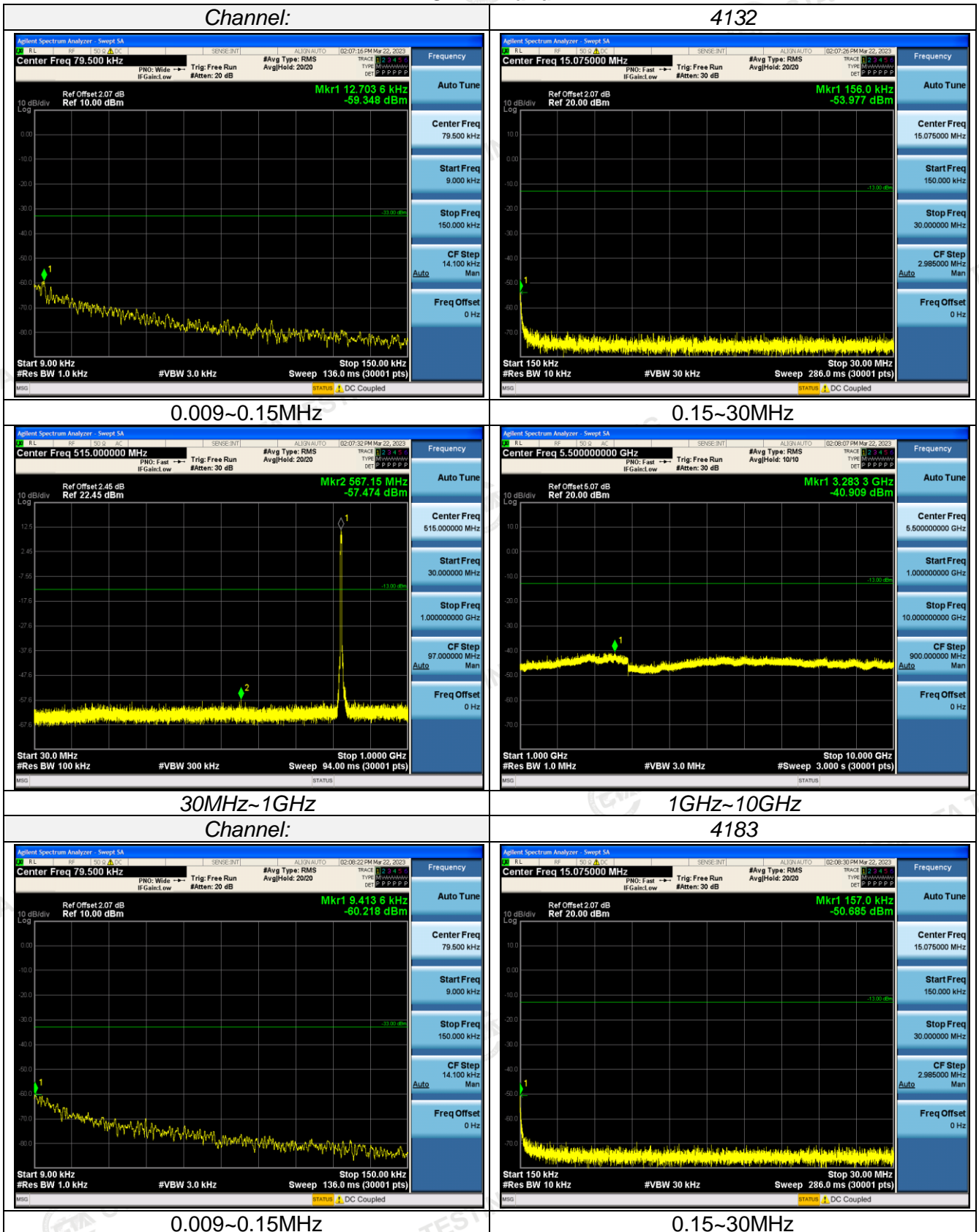

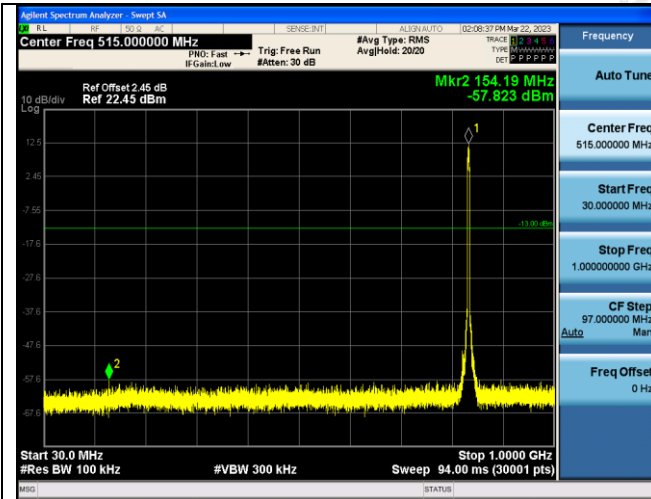

30MHz~1GHz
Channel:

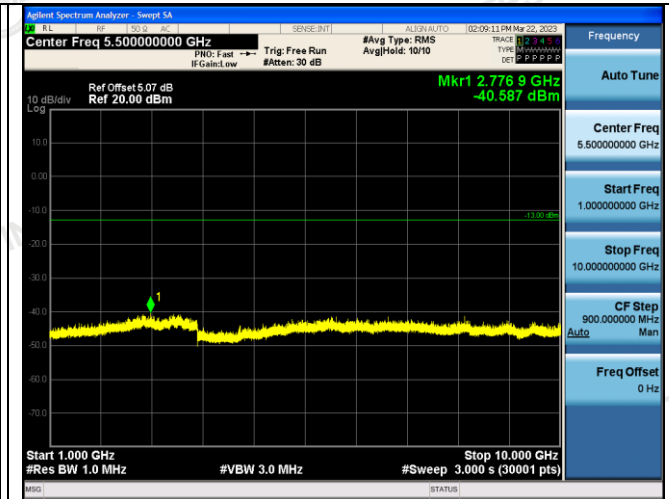

1GHz~10GHz
4233

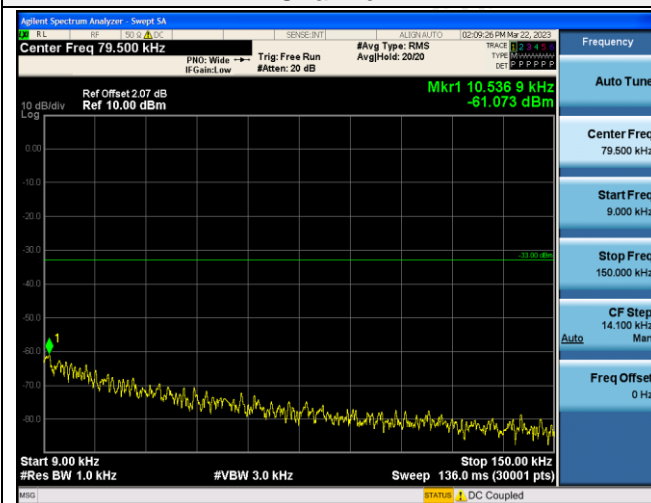

0.009~0.15MHz

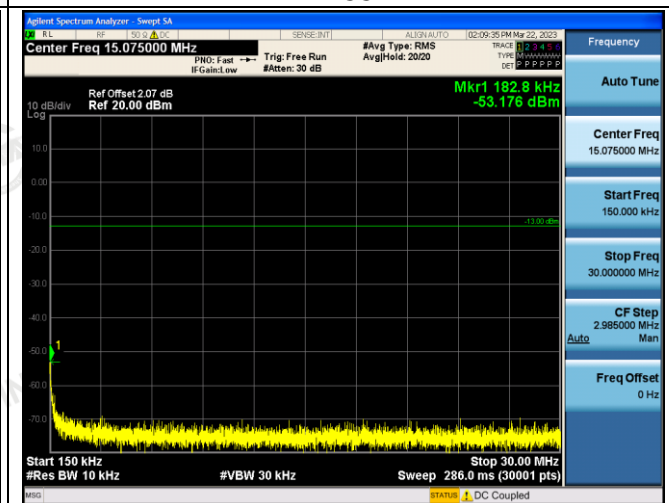

0.15~30MHz

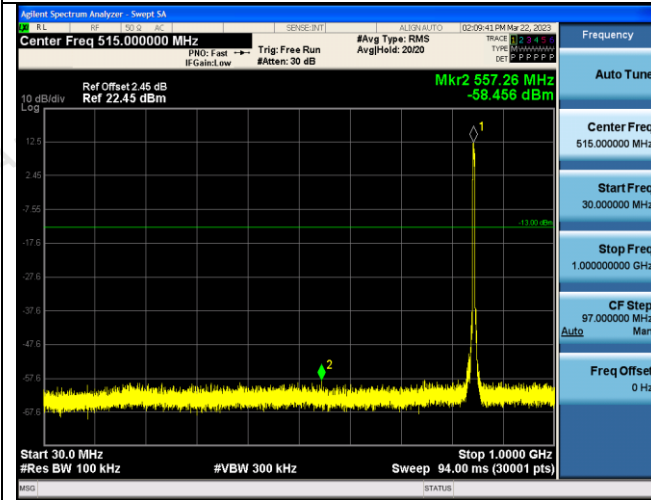

30MHz~1GHz

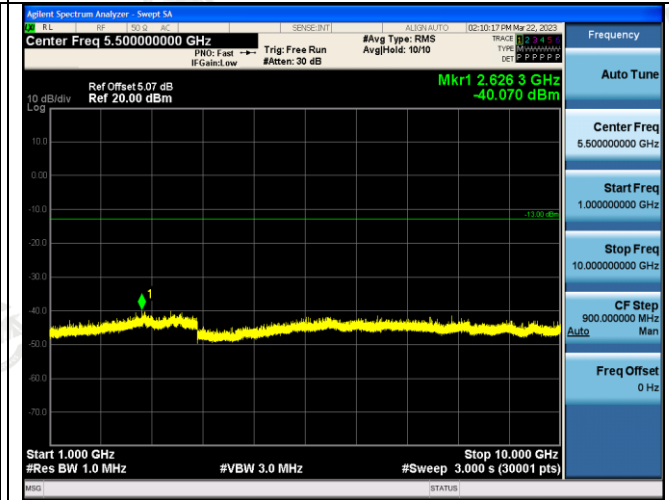

1GHz~10GHz

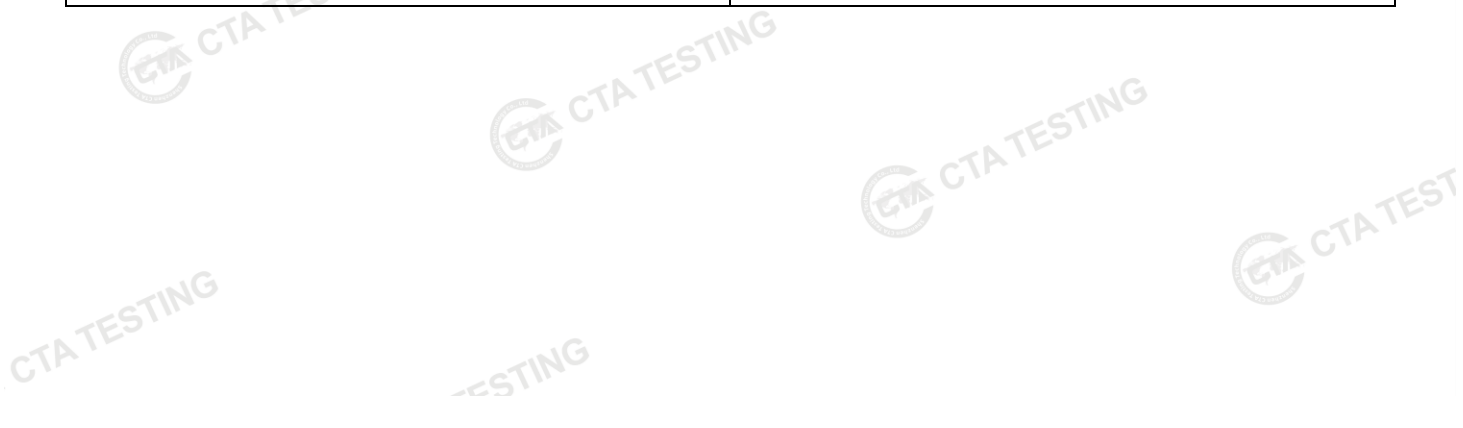

Radiated Measurement:

WCDMA Band II

Channel	Frequency (MHz)	P _{Mea} (dBm)	P _{cl} (dB)	Distance	G _a Antenna Gain(dB)	Peak EIRP (dBm)	Limit (dBm)	Margin (dB)	Polarization
9262	3704.80	-39.98	4.27	3	12.34	-31.91	-13	-18.91	H
	5557.20	-44.05	4.99	3	13.52	-35.52	-13	-22.52	H
	3704.80	-38.55	4.27	3	12.34	-30.48	-13	-17.48	V
	5557.20	-41.39	4.99	3	13.52	-32.86	-13	-19.86	V
9400	3760.00	-39.05	4.38	3	12.34	-31.09	-13	-18.09	H
	5640.00	-43.42	5.01	3	13.58	-34.85	-13	-21.85	H
	3760.00	-36.41	4.38	3	12.34	-28.45	-13	-15.45	V
	5640.00	-41.47	5.01	3	13.58	-32.90	-13	-19.90	V
9538	3815.20	-38.27	4.47	3	12.45	-30.29	-13	-17.29	H
	5722.80	-42.91	5.23	3	13.66	-34.48	-13	-21.48	H
	3815.20	-36.71	4.47	3	12.45	-28.73	-13	-15.73	V
	5722.80	-40.37	5.23	3	13.66	-31.94	-13	-18.94	V

WCDMA Band IV

Channel	Frequency (MHz)	P _{Mea} (dBm)	P _{cl} (dB)	Distance	G _a Antenna Gain(dB)	Peak EIRP (dBm)	Limit (dBm)	Margin (dB)	Polarization
1312	3424.80	-38.76	3.98	3	10.98	-31.76	-13	-18.76	H
	5137.20	-43.21	4.11	3	11.47	-35.85	-13	-22.85	H
	3424.80	-36.67	3.98	3	10.98	-29.67	-13	-16.67	V
	5137.20	-40.59	4.11	3	11.47	-33.23	-13	-20.23	V
1413	3465.20	-38.43	4.01	3	11.25	-31.19	-13	-18.19	H
	5197.80	-41.48	4.15	3	11.58	-34.05	-13	-21.05	H
	3465.20	-36.14	4.01	3	11.25	-28.90	-13	-15.90	V
	5197.80	-38.75	4.15	3	11.58	-31.32	-13	-18.32	V
1513	3505.20	-38.39	4.07	3	11.33	-31.13	-13	-18.13	H
	5275.80	-41.85	4.21	3	11.67	-34.39	-13	-21.39	H
	3505.20	-35.34	4.07	3	11.33	-28.08	-13	-15.08	V
	5275.80	-40.23	4.21	3	11.67	-32.77	-13	-19.77	V

WCDMA Band V

Channel	Frequency (MHz)	P _{Mea} (dBm)	P _{cl} (dB)	Distance	G _a Antenna Gain(dB)	Peak EIRP (dBm)	Limit (dBm)	Margin (dB)	Polarization
9262	1652.80	-36.03	3.02	3	9.58	-29.47	-13	-16.47	H
	2479.20	-40.61	3.51	3	10.72	-33.40	-13	-20.40	H
	1652.80	-34.47	3.02	3	9.68	-27.81	-13	-14.81	V
	2479.20	-38.87	3.51	3	10.72	-31.66	-13	-18.66	V
9400	1673.20	-36.07	3.14	3	9.61	-29.60	-13	-16.60	H
	2509.80	-41.02	3.59	3	10.77	-33.84	-13	-20.84	H
	1673.20	-34.65	3.14	3	9.61	-28.18	-13	-15.18	V
	2509.80	-38.80	3.59	3	10.77	-31.62	-13	-18.62	V
9538	1693.20	-36.14	3.24	3	9.77	-29.61	-13	-16.61	H
	2539.80	-40.02	3.65	3	10.89	-32.78	-13	-19.78	H
	1693.20	-34.60	3.24	3	9.77	-28.07	-13	-15.07	V
	2539.80	-37.33	3.65	3	10.89	-30.09	-13	-17.09	V

Remark:

1. $EIRP = P_{Mea}(dBm) - P_{cl}(dB) + G_a(dBi)$
2. We were not recorded other points as values lower than limits.
3. $Margin = EIRP - Limit$

3.5 Peak-to-Average Ratio (PAR)

LIMIT

The Peak-to-Average Ratio (PAR) of the transmission may not exceed 13 dB.

TEST CONFIGURATION

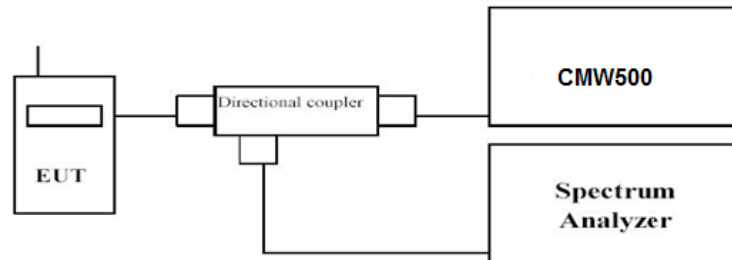

TEST PROCEDURE

1. Refer to instrument's analyzer instruction manual for details on how to use the power statistics/CCDF function;
2. Set resolution/measurement bandwidth \geq signal's occupied bandwidth;
3. Set the number of counts to a value that stabilizes the measured CCDF curve;
4. Set the measurement interval as follows: 1). for continuous transmissions, set to 1 ms, 2). for burst transmissions, employ an external trigger that is synchronized with the EUT burst timing sequence, or use the internal burst trigger with a trigger level that allows the burst to stabilize and set the measurement interval to a time that is less than or equal to the burst duration.
5. Record the maximum PAPR level associated with a probability of 0.1%.

TEST RESULTS

Test mode	Channel	Frequency (MHz)	PAPR Value (dB)	Limits (dB)	Verdict
WCDMA Band II	9262	1852.4	2.93	13.0	Pass
	9400	1880.0	2.95	13.0	Pass
	9538	1907.6	2.96	13.0	Pass
WCDMA Band IV	1312	1712.4	3.09	13.0	Pass
	1413	1732.6	3.09	13.0	Pass
	1513	1752.6	3.09	13.0	Pass
WCDMA Band V	4132	826.4	3.05	13.0	Pass
	4183	836.6	3.05	13.0	Pass
	4233	846.6	3.03	13.0	Pass

Band2-9262

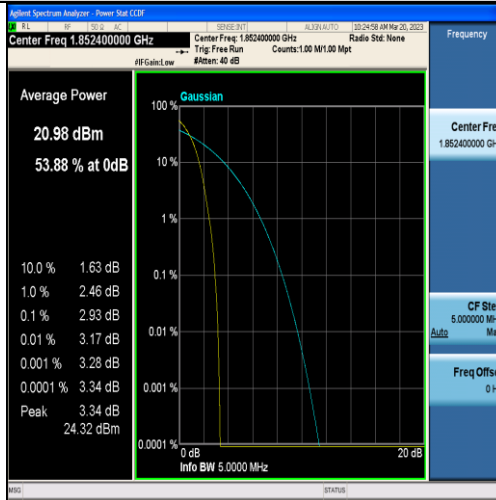

Band2-9400

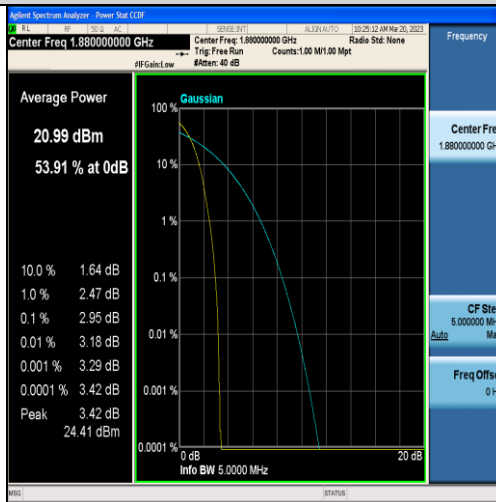

Band2-9538

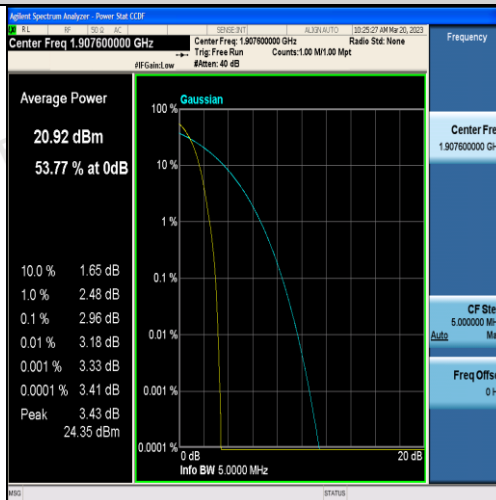

Band4-1312

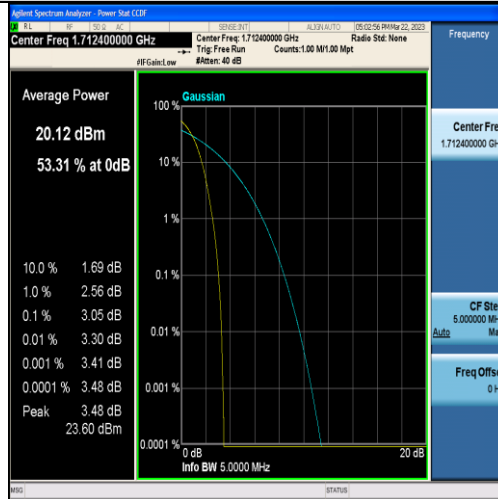

Band4-1413

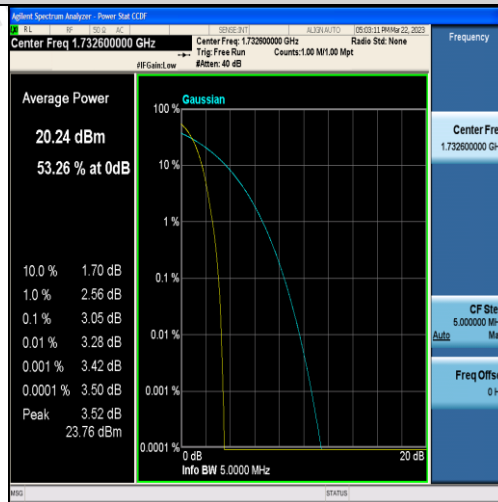

Band4-1513

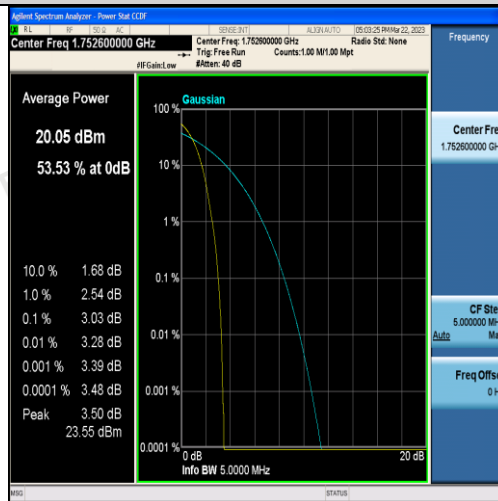

Band5-4132

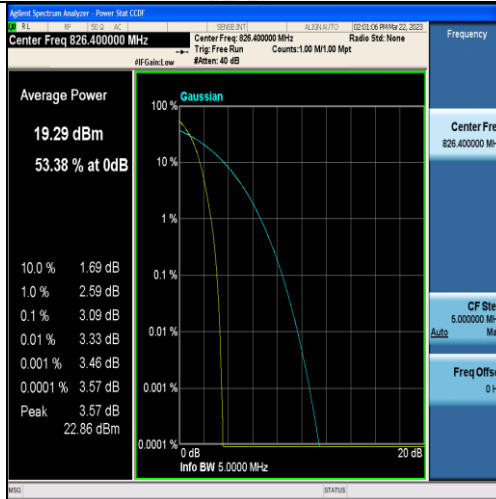

Band5-4183

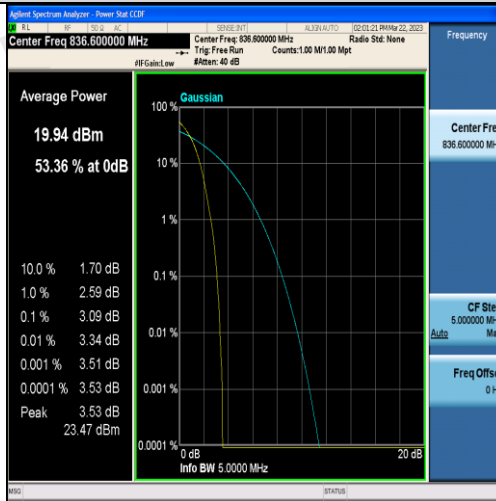

Band5-4233

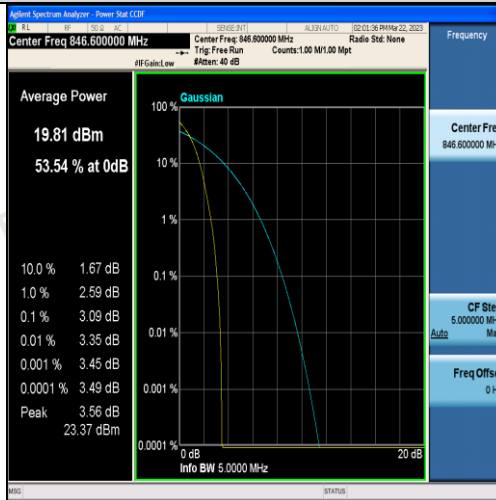

3.6 Frequency Stability under Temperature & Voltage Variations

LIMIT

Cellular Band: ± 2.5 ppm PCS Band: Within the authorized frequency block

TEST CONFIGURATION

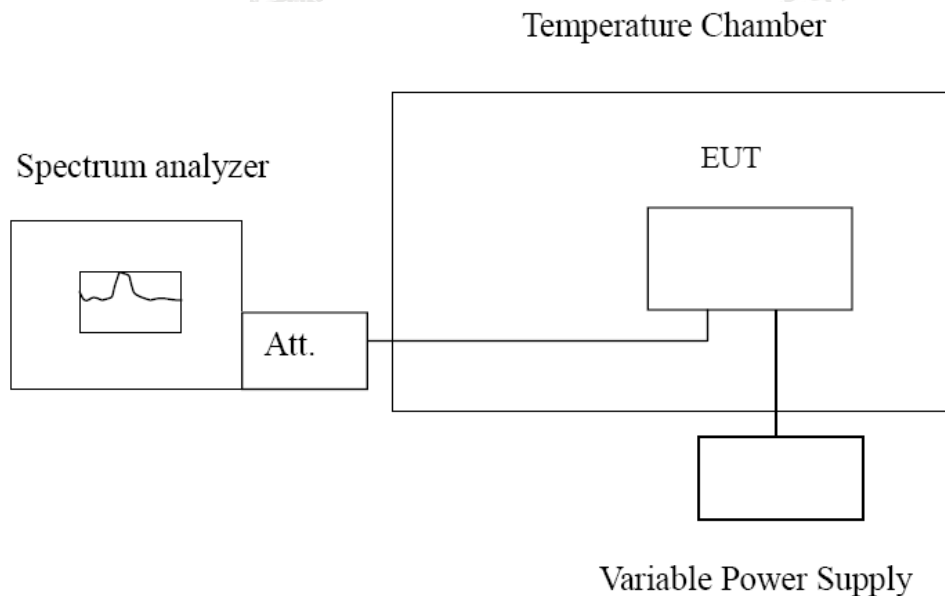

TEST PROCEDURE

The EUT was setup according to EIA/TIA 603C

Frequency Stability under Temperature Variations:

The equipment under test was connected to an external AC or DC power supply and input rated voltage. RF output was connected to a frequency counter or spectrum analyzer via feed through attenuators. The EUT was placed inside the temperature chamber. Set the spectrum analyzer RBW low enough to obtain the desired frequency resolution and measure EUT 20°C operating frequency as reference frequency. Turn EUT off and set the chamber temperature to -30°C. After the temperature stabilized for approximately 30 minutes recorded the frequency. Repeat step measure with 10°C increased per stage until the highest temperature of +50°C reached.

Frequency Stability under Voltage Variations:

Set chamber temperature to 20°C. Use a variable AC power supply / DC power source to power the EUT and set the voltage to rated voltage. Set the spectrum analyzer RBW low enough to obtain the desired frequency resolution and recorded the frequency.

Reduce the input voltage to specify extreme voltage variation ($\pm 15\%$) and endpoint, record the maximum frequency change.

TEST RESULTS

Reference Frequency: WCDMA Band II Middle channel=9400 channel=1880MHz					
Voltage (V)	Temperature (°C)	Frequency error		Limit (ppm)	Result
		Hz	ppm		
DC 5.0V	-30	-6	-0.003	±2.5	Pass
	-20	14	0.007		
	-10	-5	-0.003		
	0	-1	-0.001		
	10	9	0.005		
	20	-16	-0.009		
	30	9	0.005		
	40	-4	-0.002		
50	-2	-0.001			
DC 5.5V	25	-2	-0.001		
DC 4.5V	25	-8	-0.004		

Reference Frequency: WCDMA Band IV Middle channel=1413 channel=1732.6MHz					
Voltage (V)	Temperature (°C)	Frequency error		Limit (ppm)	Result
		Hz	ppm		
DC 5.0V	-30	6	0.003	±2.5	Pass
	-20	6	0.003		
	-10	3	0.002		
	0	-10	-0.006		
	10	-16	-0.009		
	20	-20	-0.011		
	30	-13	-0.007		
	40	-4	-0.002		
50	7	0.004			
DC 5.5V	25	6	0.003		
DC 4.5V	25	-8	-0.005		

Reference Frequency: WCDMA Band V Middle channel=4182 channel=836.6MHz					
Voltage (V)	Temperature (°C)	Frequency error		Limit (ppm)	Result
		Hz	ppm		
DC 5.0V	-30	-0.011	2.50	±2.5	Pass
	-20	-0.017	2.50		
	-10	0.011	2.50		
	0	0.000	2.50		
	10	-0.019	2.50		
	20	-0.018	2.50		
	30	-0.001	2.50		
	40	0.023	2.50		
50	0.005	2.50			
DC 5.5V	25	-0.008	2.50		
DC 4.5V	25	0.004	2.50		

4 Test Setup Photos of the EUT

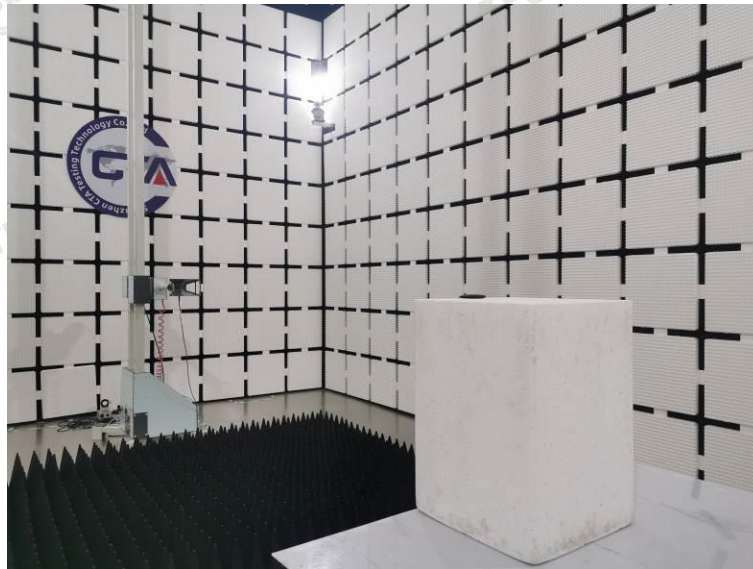

5 External and Internal Photos of the EUT

Reference to the test report No. CTA23031300201.

***** End of Report *****