



FCC TEST REPORT

For
Yuyuanfeng Tech (Shenzhen) Co., Ltd.
Power Strip

Test Model: YA36WS-8AU4UW

Prepared for : Yuyuanfeng Tech (Shenzhen) Co., Ltd.
Address : 3-4F, BLDG4, Huimingsheng Industrial Park, Fuyong St.,
Bao'an Dist., Shenzhen City, Guangdong Province, China

Prepared by : Shenzhen LCS Compliance Testing Laboratory Ltd.
Address : 101, 201 Bldg A & 301 Bldg C, Juji Industrial Park
Yabianxueziwei, Shajing Street, Baoan District, Shenzhen,
518000, China

Tel : (+86)755-82591330
Fax : (+86)755-82591332
Web : www.LCS-cert.com
Mail : webmaster@LCS-cert.com

Date of receipt of test sample : April 19, 2022
Number of tested samples : 2
Serial number : 220415082A-1, 220415082A-2
Date of Test : April 19, 2022 ~ April 28, 2022
Date of Report : May 05, 2022





FCC TEST REPORT
FCC CFR 47 PART 15C

Report Reference No. : LCS220415082AEA

Date Of Issue : May 05, 2022

Testing Laboratory Name: Shenzhen LCS Compliance Testing Laboratory Ltd.

Address : 101, 201 Bldg A & 301 Bldg C, Juji Industrial Park
Yabianxueziwei, Shajing Street, Baoan District, Shenzhen,
518000, China

Testing Location/ Procedure : Full application of Harmonised standards
Partial application of Harmonised standards
Other standard testing method

Applicant's Name : Yuyuanfeng Tech (Shenzhen) Co., Ltd.

Address : 3-4F, BLDG4, Huimingsheng Industrial Park, Fuyong St., Bao'an
Dist., Shenzhen City, Guangdong Porvince, China

Test Specification

Standard : FCC CFR 47 PART 15C

Test Report Form No. : LCSEMC-1.0

TRF Originator : Shenzhen LCS Compliance Testing Laboratory Ltd.

Master TRF : Dated 2011-03

Shenzhen LCS Compliance Testing Laboratory Ltd. All rights reserved.

This publication may be reproduced in whole or in part for non-commercial purposes as long as the Shenzhen LCS Compliance Testing Laboratory Ltd. is acknowledged as copyright owner and source of the material. Shenzhen LCS Compliance Testing Laboratory Ltd. takes no responsibility for and will not assume liability for damages resulting from the reader's interpretation of the reproduced material due to its placement and context.

Test Item Description: Power Strip

Trade Mark : bototek

Test Model : YA36WS-8AU4UW

Power Supply : Input: 100-125V~ 60Hz
Wireless Charger Output: 15W (Max)

Result : Positive

Compiled by:

Jin Wang

Jin Wang / Administrator

Supervised by:

Cary Luo

Cary Luo / Technique principal

Approved by:

Gavin Liang

Gavin Liang / Manager





FCC TEST REPORT

Test Report No. : LCS220415082AEA	<u>May 05, 2022</u> Date of issue
--	--------------------------------------

Test Model.....	: YA36WS-8AU4UW
EUT.....	: Power Strip
Applicant.....	: Yuyuanfeng Tech (Shenzhen) Co., Ltd.
Address.....	: 3-4F, BLDG4, Huimingsheng Industrial Park, Fuyong St., Bao'an Dist., Shenzhen City, Guangdong Porvince, China
Telephone.....	: /
Fax.....	: /
Manufacturer.....	: Yuyuanfeng Tech (Shenzhen) Co., Ltd.
Address.....	: 3-4F, BLDG4, Huimingsheng Industrial Park, Fuyong St., Bao'an Dist., Shenzhen City, Guangdong Porvince, China
Telephone.....	: /
Fax.....	: /
Factory.....	: Yuyuanfeng Tech (Shenzhen) Co., Ltd.
Address.....	: 3-4F, BLDG4, Huimingsheng Industrial Park, Fuyong St., Bao'an Dist., Shenzhen City, Guangdong Porvince, China
Telephone.....	: /
Fax.....	: /

Test Result	Positive
--------------------	-----------------

The test report merely corresponds to the test sample.
It is not permitted to copy extracts of these test result without the written permission of the test laboratory.





Revision History

Report Version	Issue Date	Revision Content	Revised By
000	May 05, 2022	Initial Issue	---





TABLE OF CONTENTS

- 1. GENERAL INFORMATION.....6**
 - 1.1 Description of Device (EUT)6
 - 1.2 Support equipment List.....6
 - 1.3 External I/O Cable6
 - 1.4 Description of Test Facility6
 - 1.5 Statement of the Measurement Uncertainty.....7
 - 1.6 Measurement Uncertainty7
 - 1.7 Description of Test Modes.....7
- 2. TEST METHODOLOGY8**
 - 2.1 EUT Configuration8
 - 2.2 EUT Exercise.....8
 - 2.3 General Test Procedures8
 - 2.3.1 Conducted Emissions8
 - 2.3.2 Radiated Emissions8
- 3. SYSTEM TEST CONFIGURATION.....9**
 - 3.1 Justification9
 - 3.2 EUT Exercise Software.....9
 - 3.3 Special Accessories9
 - 3.4 Block Diagram/Schematics9
 - 3.5 Equipment Modifications9
 - 3.6 Test Setup.....9
- 4. SUMMARY OF TEST EQUIPMENT10**
- 5. SUMMARY OF TEST RESULT11**
- 6. POWER LINE CONDUCTED MEASUREMENT12**
- 7. RADIATED EMISSION MEASUREMENT15**
 - 7.1. Block Diagram of Test Setup.....15
 - 7.2. Radiated Emission Limit.....16
 - 7.3. EUT Configuration on Measurement.....16
 - 7.4. Operating Condition of EUT.....16
 - 7.5. Measuring Setting.....17
 - 7.6. Test Procedure17
 - 7.7. Test Results.....18
- 8. 20 DB BANDWIDTH MEASUREMENT23**
 - 8.1. Block Diagram of Test Setup.....23
 - 8.2. Test Procedure23
 - 8.3. Test Results.....24
- 9. PHOTOGRAPHS OF TEST SETUP25**
- 10. EXTERNAL PHOTOGRAPHS OF THE EUT25**
- 11. INTERNAL PHOTOGRAPHS OF THE EUT25**





1. GENERAL INFORMATION

1.1 Description of Device (EUT)

EUT : Power Strip

Test Model : YA36WS-8AU4UW

Power Supply : Input: 100-125V~ 60Hz
Wireless Charger Output: 15W (Max)

Hardware Version : /

Software Version : /

Wireless Charging :

Operating Frequency : 111.0~205.0KHz

Modulation Type : ASK

Antenna Type : Coil Antenna

1.2 Support equipment List

Manufacturer	Description	Model	Serial Number	Certificate
Apple	Phone	ipone 11	--	FCC

Note: The mobile phone is supplied by lab and only use tested.

1.3 External I/O Cable

I/O Port Description	Quantity	Cable
--	--	--

1.4 Description of Test Facility

NVLAP Accreditation Code is 600167-0.
 FCC Designation Number is CN5024
 CAB identifier is CN0071.
 CNAS Registration Number is L4595.
 Test Firm Registration Number: 254912

The 3m-Semi anechoic test site fulfils CISPR 16-1-4 according to ANSI C63.4:2014 and CISPR 16-1-4:2010 SVSWR requirement for radiated emission above 1GHz.





1.5 Statement of the Measurement Uncertainty

The data and results referenced in this document are true and accurate. The reader is cautioned that there may be errors within the calibration limits of the equipment and facilities. The measurement uncertainty was calculated for all measurements listed in this test report acc. To CISPR 16 – 4 “Specification for radio disturbance and immunity measuring apparatus and methods – Part 4: Uncertainty in EMC Measurements” and is documented in the LCS quality system acc. To DIN EN ISO/IEC 17025. Furthermore, component and process variability of devices similar to that tested may result in additional deviation. The manufacturer has the sole responsibility of continued compliance of the device.

1.6 Measurement Uncertainty

Test Item	Frequency Range	Uncertainty	Note
Radiation Uncertainty	9KHz~30MHz	3.10dB	(1)
	30MHz~200MHz	2.96dB	(1)
	200MHz~1000MHz	3.10dB	(1)
	1GHz~26.5GHz	3.80dB	(1)
	26.5GHz~40GHz	3.90dB	(1)
Conduction Uncertainty	150kHz~30MHz	1.63dB	(1)
Power disturbance	30MHz~300MHz	1.60dB	(1)

(1). This uncertainty represents an expanded uncertainty expressed at approximately the 95% confidence level using a coverage factor of k=2.

1.7 Description of Test Modes

Equipment under test was operated during the measurement under the following conditions:

Charging and communication mode

Modulation Type: ASK

Test Modes		
Mode 1	EUT+Mobile Phone (Battery Status: <1%)	Record
Mode 2	EUT+Mobile Phone (Battery Status: <50%)	Pre-tested
Mode 3	EUT+Mobile Phone (Battery Status: <100%)	Pre-tested
Note: All test modes were pre-tested, but we only recorded the worst case in this report.		





2. TEST METHODOLOGY

The tests documented in this report were performed in accordance with ANSI C63.10-2013, FCC CFR PART 15C 15.207 and DA 00-705.

2.1 EUT Configuration

The EUT configuration for testing is installed on RF field strength measurement to meet the Commissions requirement and operating in a manner that intends to maximize its emission characteristics in a continuous normal application.

2.2 EUT Exercise

The EUT was operated in the normal operating mode for Hopping Numbers and Dwell Time test and a continuous transmits mode for other tests.

According to its specifications, the EUT must comply with the requirements of the Section 15.207 under the FCC Rules Part 15 Subpart C.

2.3 General Test Procedures

2.3.1 Conducted Emissions

The EUT is placed on the turntable, which is 0.8 m above ground plane. According to the requirements in Section 6.2.1 of ANSI C63.10-2013 Conducted emissions from the EUT measured in the frequency range between 0.15 MHz and 30MHz using Quasi-peak and average detector modes.

2.3.2 Radiated Emissions

The EUT is placed on a turn table, which is 0.8 m above ground plane below 1GHz and 1.5 m above ground plane above 1GHz. The turntable shall rotate 360 degrees to determine the position of maximum emission level. EUT is set 3m away from the receiving antenna, which varied from 1m to 4m to find out the highest emission. And also, each emission was to be maximized by changing the polarization of receiving antenna both horizontal and vertical. In order to find out the maximum emissions, exploratory radiated emission measurements were made according to the requirements in Section 6.3 of ANSI C63.10-2013





3. SYSTEM TEST CONFIGURATION

3.1 Justification

The system was configured for testing in a normal condition.

3.2 EUT Exercise Software

N/A.

3.3 Special Accessories

N/A.

3.4 Block Diagram/Schematics

Please refer to the related document.

3.5 Equipment Modifications

Shenzhen LCS Compliance Testing Laboratory Ltd. has not done any modification on the EUT.

3.6 Test Setup

Please refer to the test setup photo.



Shenzhen LCS Compliance Testing Laboratory Ltd.

Add: 101, 201 Bldg A & 301 Bldg C, Juji Industrial Park Yabianxueziwei, Shajing Street, Baoan District, Shenzhen, 518000, China

Tel: +(86) 0755-82591330 | E-mail: webmaster@lcs-cert.com | Web: www.lcs-cert.com

Scan code to check authenticity



4. SUMMARY OF TEST EQUIPMENT

Item	Equipment	Manufacturer	Model No.	Serial No.	Cal Date	Due Date
1	MXA Signal Analyzer	Agilent	N9020A	MY49100040	2021-06-17	2022-06-16
2	SPECTRUM ANALYZER	R&S	FSP40	100503	2021-11-16	2022-11-15
3	3m Semi Anechoic Chamber	SIDT FRANKONIA	SAC-3M	03CH03-HY	2021-09-25	2022-09-24
4	Positioning Controller	MF	MF-7082	/	2021-06-21	2022-06-20
5	EMI Test Software	EZ	EZ-EMC	/	N/A	N/A
6	EMI Test Receiver	R&S	ESR 7	101181	2021-06-21	2022-06-20
7	Active Loop Antenna	SCHWARZBECK	FMZB 1519B	00005	2021-06-30	2024-07-01
8	By-log Antenna	SCHWARZBECK	VULB9163	9163-470	2021-06-30	2024-07-01
9	Horn Antenna	SCHWARZBECK	BBHA 9120D	9120D-1925	2021-06-30	2024-07-01
10	RF Cable-R03m	Jye Bao	RG142	CB021	2021-06-21	2022-06-20
11	RF Cable-HIGH	SUHNER	SUCOFLEX 106	03CH03-HY	2021-06-21	2022-06-20
12	EMI Test Receiver	R&S	ESPI	101840	2021-06-21	2022-06-20
13	Artificial Mains	R&S	ENV216	101288	2021-06-21	2022-06-20
14	10dB Attenuator	SCHWARZBECK	MTS-IMP-136	261115-001-0032	2021-06-21	2022-06-20
15	Broadband Preamplifier	SCHWARZBECK	BBV9745	9719-025	2021-06-21	2022-06-20



Shenzhen LCS Compliance Testing Laboratory Ltd.

Add: 101, 201 Bldg A & 301 Bldg C, Juji Industrial Park Yabianxueziwei, Shajing Street, Baoan District, Shenzhen, 518000, China

Tel: +(86) 0755-82591330 | E-mail: webmaster@lcs-cert.com | Web: www.lcs-cert.com

Scan code to check authenticity



5. SUMMARY OF TEST RESULT

FCC Rules	Description of Test	Test Sample	Result
§15.207(a)	AC Conducted Emissions	Sample 1	Compliant
§15.209	Radiated Spurious Emissions	Sample 1	Compliant
§15.215	20 dB Bandwidth	Sample 1	Compliant

Remark: The measurement uncertainty is not included in the test result.
N/A – Not Applicable!!!





6. POWER LINE CONDUCTED MEASUREMENT

6.1. Block Diagram of Test Setup

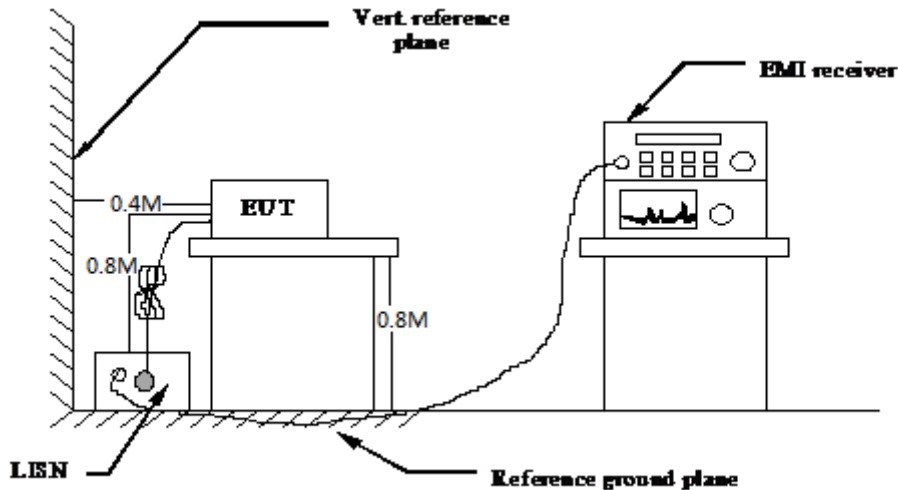

6.2. Standard Applicable

According to §15.207: For all the consumer devices which is designed to be connected to the public utility (AC) power line, the radio frequency voltage that is conducted back onto the AC power line on any frequency or frequencies within the band 150 kHz to 30 MHz shall not exceed 250 microvolts (The limit decreases linearly with the logarithm of the frequency in the range 0.15 MHz to 0.50 MHz). The limits at specific frequency range are listed as follows:

Frequency Range (MHz)	Limits (dB μ V)	
	Quasi-peak	Average
0.15 to 0.50	66 to 56	56 to 46
0.50 to 5	56	46
5 to 30	60	50

* Decreasing linearly with the logarithm of the frequency

6.3 Test Results

PASS

The test data please refer to following page.

Temperature	22.7°C	Humidity	53.7%
Test Engineer	Bill Zhu	Configurations	Transmit





AC Power Line Conducted Emission (Power input to adapter @ AC 120V/60Hz (Worst Case))

Line

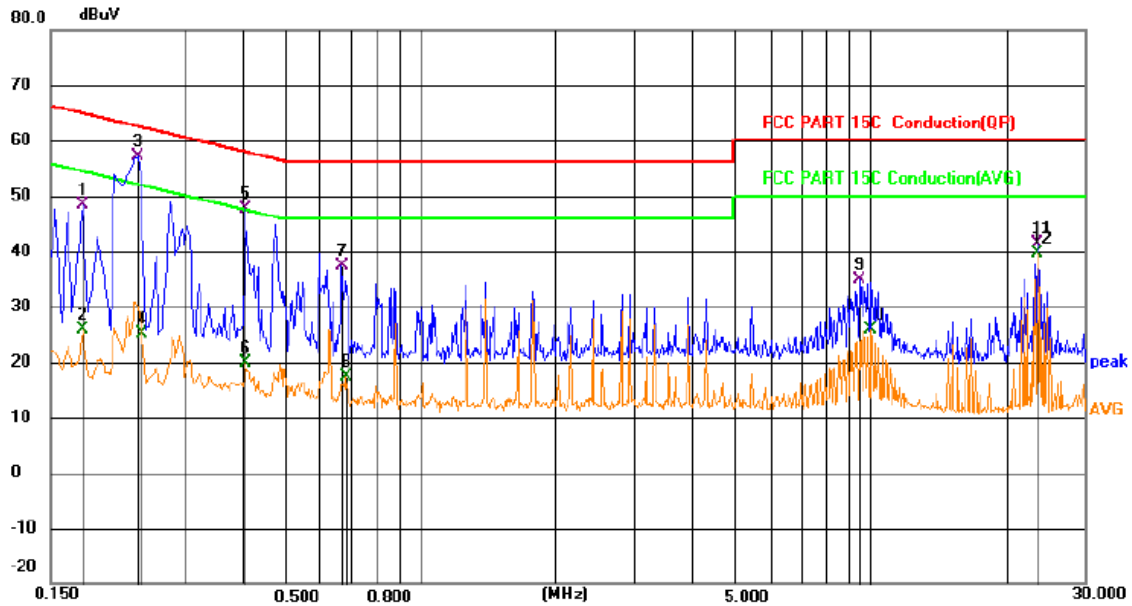

No.	Mk.	Freq. MHz	Reading Level dBuV	Correct Factor dB	Measure- ment dBuV	Limit dBuV	Margin dB	Detector	Comment
1		0.1771	28.67	19.63	48.30	64.62	-16.32	QP	
2		0.1771	6.23	19.63	25.86	54.62	-28.76	AVG	
3	*	0.2356	37.56	19.63	57.19	62.25	-5.06	QP	
4		0.2401	5.47	19.63	25.10	52.09	-26.99	AVG	
5		0.4066	28.10	19.63	47.73	57.72	-9.99	QP	
6		0.4066	0.21	19.63	19.84	47.72	-27.88	AVG	
7		0.6676	17.79	19.65	37.44	56.00	-18.56	QP	
8		0.6811	-2.35	19.65	17.30	46.00	-28.70	AVG	
9		9.4831	14.94	19.83	34.77	60.00	-25.23	QP	
10		10.0546	6.05	19.85	25.90	50.00	-24.10	AVG	
11		23.5501	21.37	20.06	41.43	60.00	-18.57	QP	
12		23.5501	19.52	20.06	39.58	50.00	-10.42	AVG	



Shenzhen LCS Compliance Testing Laboratory Ltd.

Add: 101, 201 Bldg A & 301 Bldg C, Juji Industrial Park Yabianxueziwei, Shajing Street, Baoan District, Shenzhen, 518000, China

Tel: +(86) 0755-82591330 | E-mail: webmaster@lcs-cert.com | Web: www.lcs-cert.com

Scan code to check authenticity



Neutral

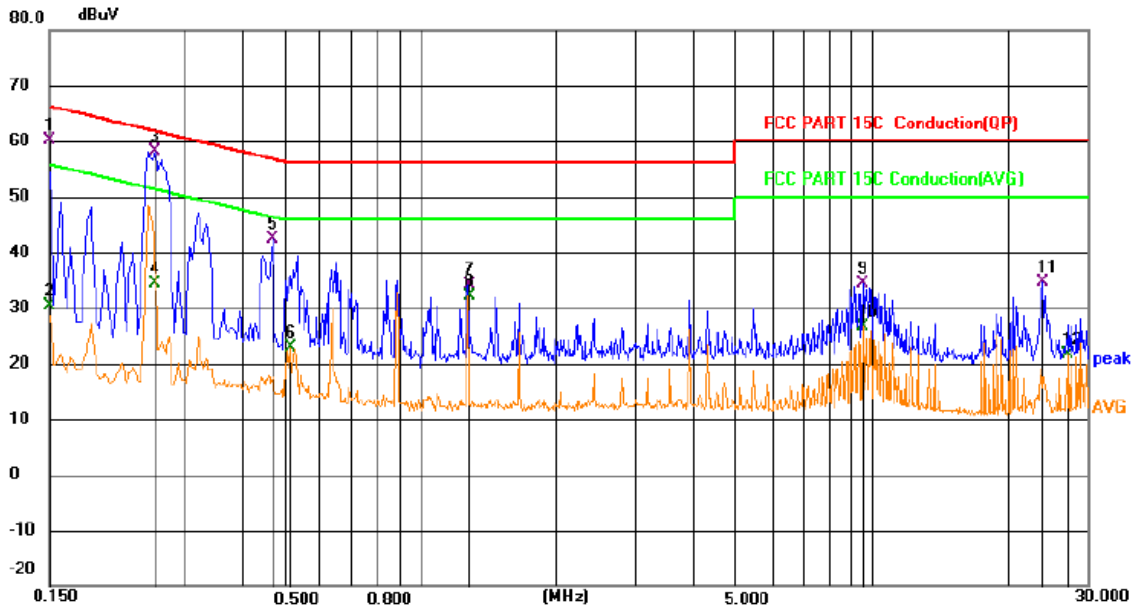

No.	Mk.	Freq. MHz	Reading Level dBuV	Correct Factor dB	Measure- ment dBuV	Limit dBuV	Margin dB	Detector	Comment
1		0.1500	40.54	19.63	60.17	66.00	-5.83	QP	
2		0.1500	10.76	19.63	30.39	56.00	-25.61	AVG	
3	*	0.2581	38.59	19.63	58.22	61.49	-3.27	QP	
4		0.2581	14.78	19.63	34.41	51.49	-17.08	AVG	
5		0.4696	22.84	19.64	42.48	56.52	-14.04	QP	
6		0.5146	3.30	19.65	22.95	46.00	-23.05	AVG	
7		1.2706	14.41	19.66	34.07	56.00	-21.93	QP	
8		1.2706	12.54	19.66	32.20	46.00	-13.80	AVG	
9		9.5461	14.44	19.85	34.29	60.00	-25.71	QP	
10		9.5461	6.82	19.85	26.67	50.00	-23.33	AVG	
11		23.8471	14.65	20.05	34.70	60.00	-25.30	QP	
12		27.2446	1.54	20.04	21.58	50.00	-28.42	AVG	

***Note: Pre-scan all modes and recorded the worst case results in this report.
Margin=Reading level + Correct - Limit





7. RADIATED EMISSION MEASUREMENT

7.1. Block Diagram of Test Setup

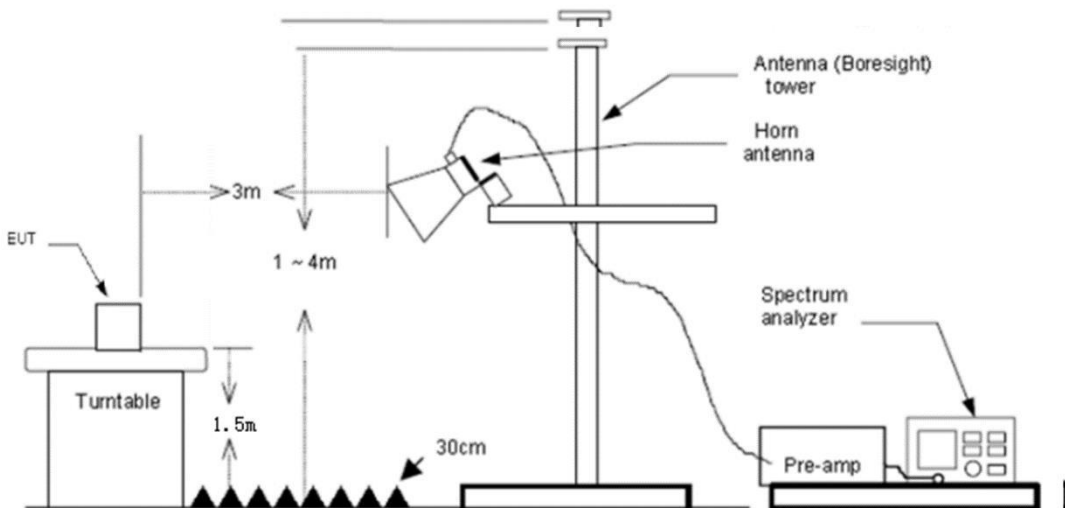
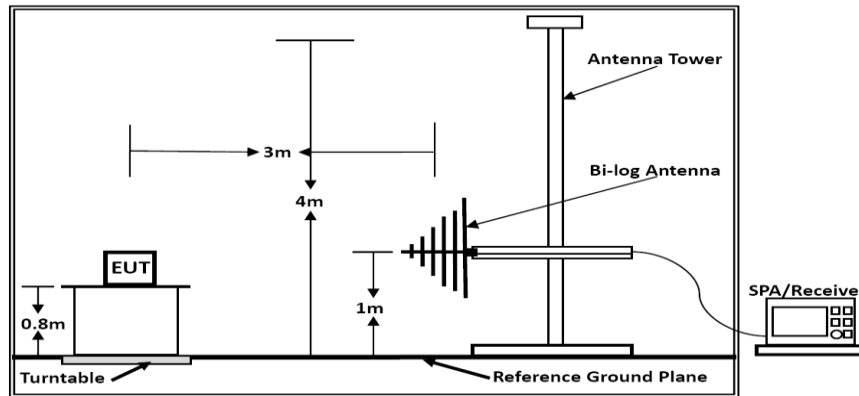
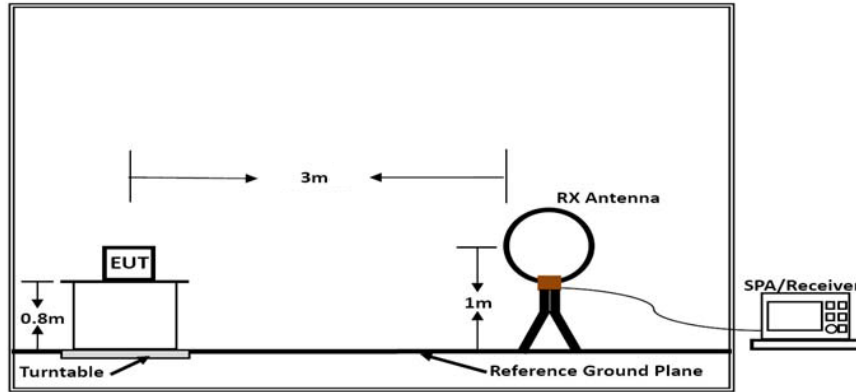



7.2. Radiated Emission Limit

15.205 (a) Except as shown in paragraph (d) of this section, only spurious emissions are permitted in any of the frequency bands listed below:

MHz	MHz	MHz	GHz
0.090-0.110	16.42-16.423	399.9-410	4.5-5.15
\1\ 0.495-0.505	16.69475-16.69525	608-614	5.35-5.46
2.1735-2.1905	16.80425-16.80475	960-1240	7.25-7.75
4.125-4.128	25.5-25.67	1300-1427	8.025-8.5
4.17725-4.17775	37.5-38.25	1435-1626	9.0-9.2
4.20725-4.20775	73-74.6	1645.5-1646.5	9.3-9.5
6.215-6.218	74.8-75.2	1660-1710	10.6-12.7
6.26775-6.26825	108-121.94	1718.8-1722.2	13.25-13.4
6.31175-6.31225	123-138	2200-2300	14.47-14.5
8.291-8.294	149.9-150.05	2310-2390	15.35-16.2
8.362-8.366	156.52475-156.52525	2483.5-2500	17.7-21.4
8.37625-8.38675	156.7-156.9	2690-2900	22.01-23.12
8.41425-8.41475	162.0125-167.17	3260-3267	23.6-24.0
12.29-12.293	167.72-173.2	3332-3339	31.2-31.8
12.51975-12.52025	240-285	3345.8-3358	36.43-36.5
12.57675-12.57725	322-335.4	3600-4400	(\2)
13.36-13.41			

\1\ Until February 1, 1999, this restricted band shall be 0.490-0.510 MHz.

\2\ Above 38.6

According to §15.247 (d): 20dBc in any 100 kHz bandwidth outside the operating frequency band. In case the emission fall within the restricted band specified on 15.205(a), then the 15.209(a) limit in the table below has to be followed.

Frequencies (MHz)	Field Strength (microvolts/meter)	Measurement Distance (meters)
0.009~0.490	2400/F(KHz)	300
0.490~1.705	24000/F(KHz)	30
1.705~30.0	30	30
30~88	100	3
88~216	150	3
216~960	200	3
Above 960	500	3

7.3. EUT Configuration on Measurement

The following equipment are installed on Radiated Emission Measurement to meet the commission requirements and operating regulations in a manner which tends to maximize its emission characteristics in normal application.

7.4. Operating Condition of EUT

- (1) Setup the EUT as shown in Section 7.1.
- (2) Let the EUT work in worst test mode1 and measure it.





7.5. Measuring Setting

The following table is the setting of spectrum analyzer and receiver.

Receiver Parameter	Setting
Attenuation	Auto
Start ~ Stop Frequency	9kHz~150kHz / RB 200Hz for QP/Average
Start ~ Stop Frequency	150kHz~30MHz / RB 9kHz for QP/Average
Start ~ Stop Frequency	30MHz~1000MHz / RB 100kHz for QP

7.6. Test Procedure

1) Sequence of testing 9 kHz to 30 MHz

Setup:

- The equipment was set up to simulate a typical usage like described in the user manual or described by manufacturer.
- If the EUT is a tabletop system, a rotatable table with 0.8 m height is used.
- If the EUT is a floor standing device, it is placed on the ground.
- Auxiliary equipment and cables were positioned to simulate normal operation conditions.
- The AC power port of the EUT (if available) is connected to a power outlet below the turntable.
- The measurement distance is 3 meter.
- The EUT was set into operation.

Premeasurement:

- The turntable rotates from 0° to 315° using 45° steps.
- The antenna height is 1 meter.
- At each turntable position the analyzer sweeps with peak detection to find the maximum of all emissions

Final measurement:

- Identified emissions during the premeasurement the software maximizes by rotating the turntable position (0° to 360°) and by rotating the elevation axes (0° to 360°).
- The final measurement will be done in the position (turntable and elevation) causing the highest emissions with QPK detector.
- The final levels, frequency, measuring time, bandwidth, turntable position, correction factor, margin to the limit and limit will be recorded. Also a plot with the graph of the premeasurement and the limit will be stored.





2) Sequence of testing 30 MHz to 1 GHz

Setup:

- The equipment was set up to simulate a typical usage like described in the user manual or described by manufacturer.
- If the EUT is a tabletop system, a table with 0.8 m height is used, which is placed on the ground plane.
- If the EUT is a floor standing device, it is placed on the ground plane with insulation between both.
- Auxiliary equipment and cables were positioned to simulate normal operation conditions
- The AC power port of the EUT (if available) is connected to a power outlet below the turntable.
- The measurement distance is 3 meter.
- The EUT was set into operation.

Premeasurement:

- The turntable rotates from 0° to 315° using 45° steps.
- The antenna is polarized vertical and horizontal.
- The antenna height changes from 1 to 3 meter.
- At each turntable position, antenna polarization and height the analyzer sweeps three times in peak to find the maximum of all emissions.

Final measurement:

- The final measurement will be performed with minimum the six highest peaks.
- According to the maximum antenna and turntable positions of premeasurement the software maximize the peaks by changing turntable position ($\pm 45^\circ$) and antenna movement between 1 and 4 meter.
- The final measurement will be done with QP detector with an EMI receiver.
- The final levels, frequency, measuring time, bandwidth, antenna height, antenna polarization, turntable angle, correction factor, margin to the limit and limit will be recorded. Also a plot with the graph of the premeasurement with marked maximum final measurements and the limit will be stored.

7.7. Test Results

PASS.

Only report the worst test data mode 1 in test report;

The test data please refer to following page:

Temperature	23.8°C	Humidity	52.5%
Test Engineer	Bill Zhu	Configurations	Transmit





0.009 MHz – 30 MHz
Horizontal



No.	Frequency (MHz)	Reading (dBuV)	Factor (dB/m)	Level (dBuV/m)	Limit (dBuV/m)	Margin (dB)	Detector
1	0.1341	92.23	-9.50	82.73	105.02	-22.29	QP
2	0.4008	69.45	-8.72	60.73	95.54	-34.81	QP
3	0.6682	59.52	-8.10	51.42	71.11	-19.69	QP
4	0.9394	52.30	-7.40	44.90	68.15	-23.25	QP
5	1.2080	47.00	-6.86	40.14	65.96	-25.82	QP
6	1.4676	43.43	-6.37	37.06	64.27	-27.21	QP



Shenzhen LCS Compliance Testing Laboratory Ltd.

Add: 101, 201 Bldg A & 301 Bldg C, Juji Industrial Park Yabianxueziwei, Shajing Street, Baoan District, Shenzhen, 518000, China

Tel: +(86) 0755-82591330 | E-mail: webmaster@lcs-cert.com | Web: www.lcs-cert.com

Scan code to check authenticity



Vertical

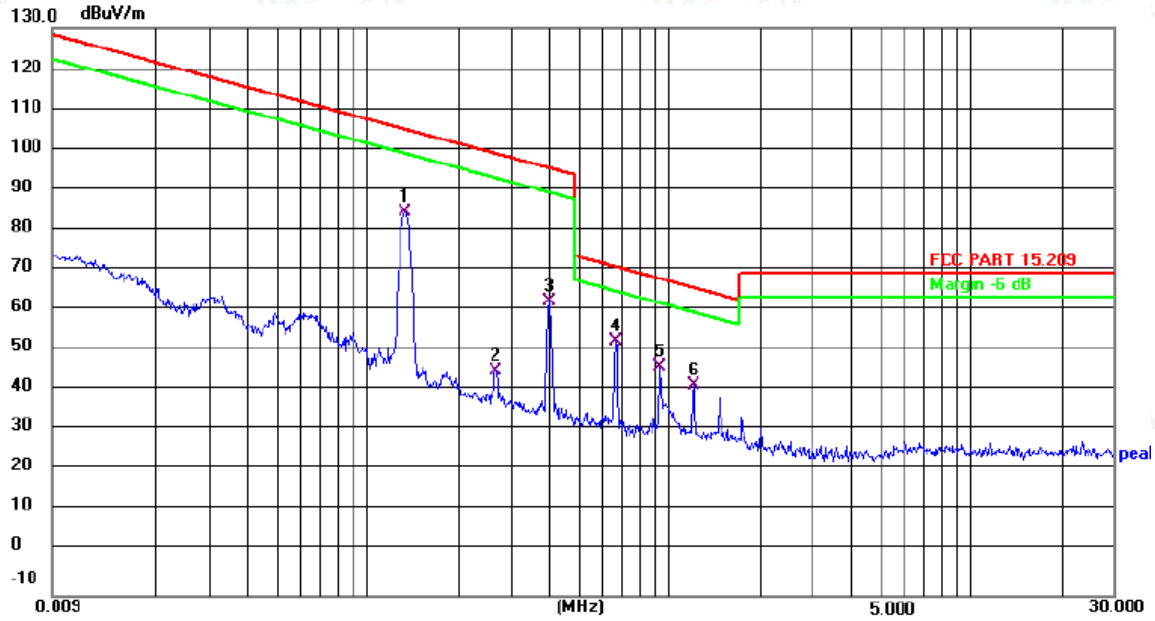

No.	Frequency (MHz)	Reading (dBuV)	Factor (dB/m)	Level (dBuV/m)	Limit (dBuV/m)	Margin (dB)	Detector
1	0.1340	94.21	-9.50	84.71	105.00	-20.29	QP
2	0.2671	54.52	-8.96	45.56	99.04	-53.48	QP
3	0.4008	71.47	-8.72	62.75	95.54	-32.79	QP
4	0.6681	60.84	-8.10	52.74	71.11	-18.37	QP
5	0.9394	54.07	-7.40	46.67	68.15	-21.48	QP
6	1.2078	48.90	-6.86	42.04	65.96	-23.92	QP

Remark: 1). Measured at antenna position 0 degree and 90 degree.
 2). Corrected Reading: Antenna Factor + Cable Loss + Read Level - Preamp Factor = Level.





Below 1GHz

Temperature	23.5°C	Humidity	52.2%
Test Engineer	Bill Zhu	Configurations	Transmit

Horizontal

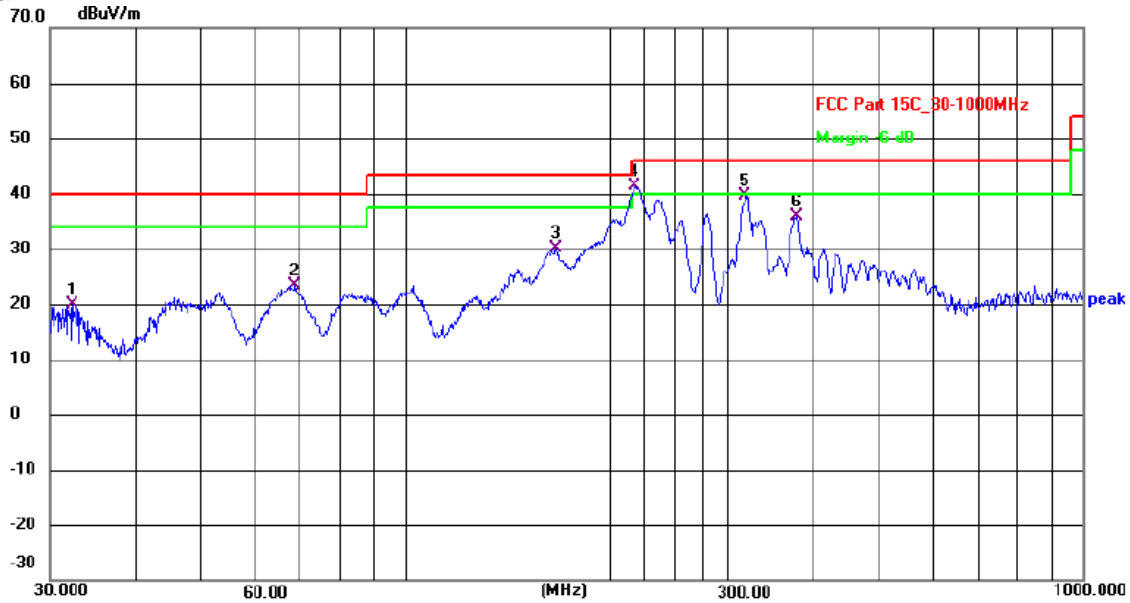

No.	Frequency (MHz)	Reading (dBuV)	Factor (dB/m)	Level (dBuV/m)	Limit (dBuV/m)	Margin (dB)	Detector
1	32.4059	37.99	-18.13	19.86	40.00	-20.14	QP
2	68.8721	42.83	-19.39	23.44	40.00	-16.56	QP
3	167.2366	49.60	-19.57	30.03	43.50	-13.47	QP
4	218.3084	58.39	-16.92	41.47	46.00	-4.53	QP
5	317.7010	54.15	-14.61	39.54	46.00	-6.46	QP
6	378.5842	50.56	-14.68	35.88	46.00	-10.12	QP





Vertical

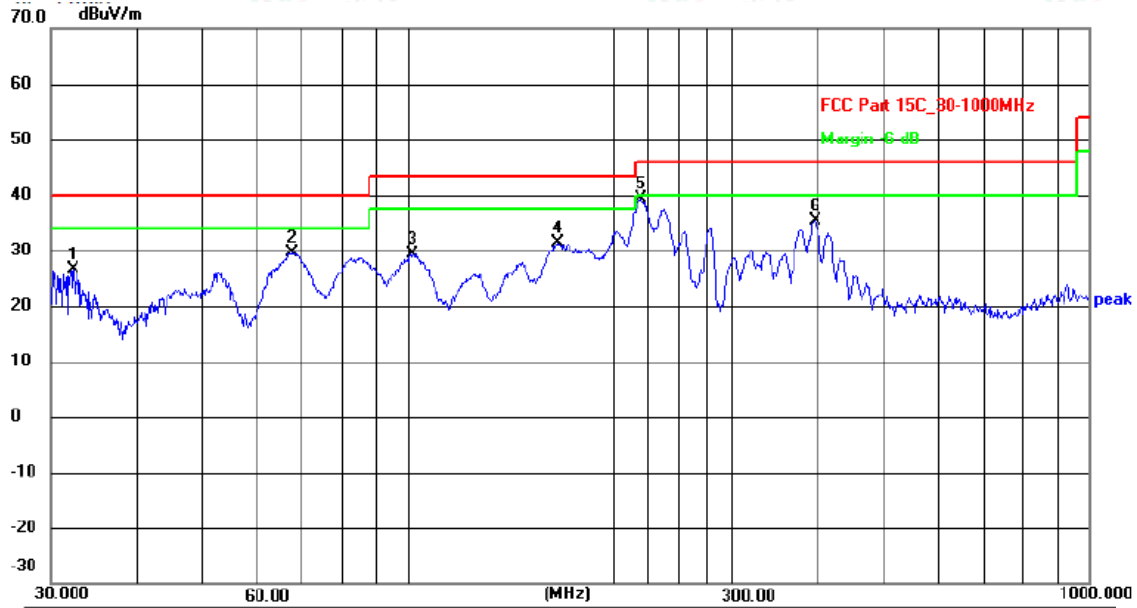

No.	Frequency (MHz)	Reading (dBuV)	Factor (dB/m)	Level (dBuV/m)	Limit (dBuV/m)	Margin (dB)	Detector
1	32.4059	44.73	-18.13	26.60	40.00	-13.40	peak
2	67.6751	48.90	-19.32	29.58	40.00	-10.42	peak
3	102.0013	47.83	-18.35	29.48	43.50	-14.02	peak
4	166.0680	50.91	-19.59	31.32	43.50	-12.18	peak
5	219.8448	56.18	-16.88	39.30	46.00	-6.70	peak
6	394.8545	49.80	-14.48	35.32	46.00	-10.68	peak

1). Emission level (dBuV/m) = 20 log Emission level (uV/m).

2). Corrected Reading: Antenna Factor + Cable Loss + Read Level - Preamp Factor = Level.



Shenzhen LCS Compliance Testing Laboratory Ltd.

Add: 101, 201 Bldg A & 301 Bldg C, Juji Industrial Park Yabianxueziwei, Shajing Street, Baoan District, Shenzhen, 518000, China

Tel: +(86) 0755-82591330 | E-mail: webmaster@lcs-cert.com | Web: www.lcs-cert.com

Scan code to check authenticity



8. 20 DB BANDWIDTH MEASUREMENT

8.1. Block Diagram of Test Setup

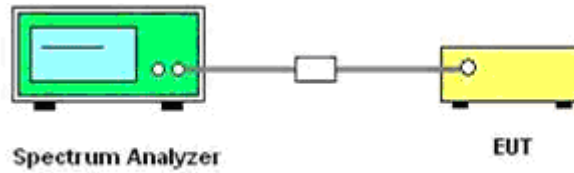

8.2. Test Procedure

Use the following spectrum analyzer settings:

Span = 500Hz

RBW = 100Hz

VBW = 300Hz

Sweep = auto

Detector function = peak

Trace = max hold

The EUT should be transmitting at its maximum data rate. Allow the trace to stabilize. Use the marker-to-peak function to set the marker to the peak of the emission. Use the marker-delta function to measure 20 dB down one side of the emission. Reset the marker-delta function, and move the marker to the other side of the emission, until it is (as close as possible to) even with the reference marker level. The marker-delta reading at this point is the 20 dB bandwidth of the emission. If this value varies with different modes of operation (e.g., data rate, modulation format, etc.), repeat this test for each variation. The limit is specified in one of the subparagraphs of this Section. Submit this plot(s).



Shenzhen LCS Compliance Testing Laboratory Ltd.

Add: 101, 201 Bldg A & 301 Bldg C, Juji Industrial Park Yabianxueziwei, Shajing Street, Baoan District, Shenzhen, 518000, China

Tel: +(86) 0755-82591330 | E-mail: webmaster@lcs-cert.com | Web: www.lcs-cert.com

Scan code to check authenticity



8.3. Test Results

Test Result Of 20dB Bandwidth Measurement		
Test Frequency (MHz)	20dB Bandwidth (kHz)	Limit (KHz)
0.125	0.26	Non-Specified

Result: Pass

Please refer to the following page for test plot.

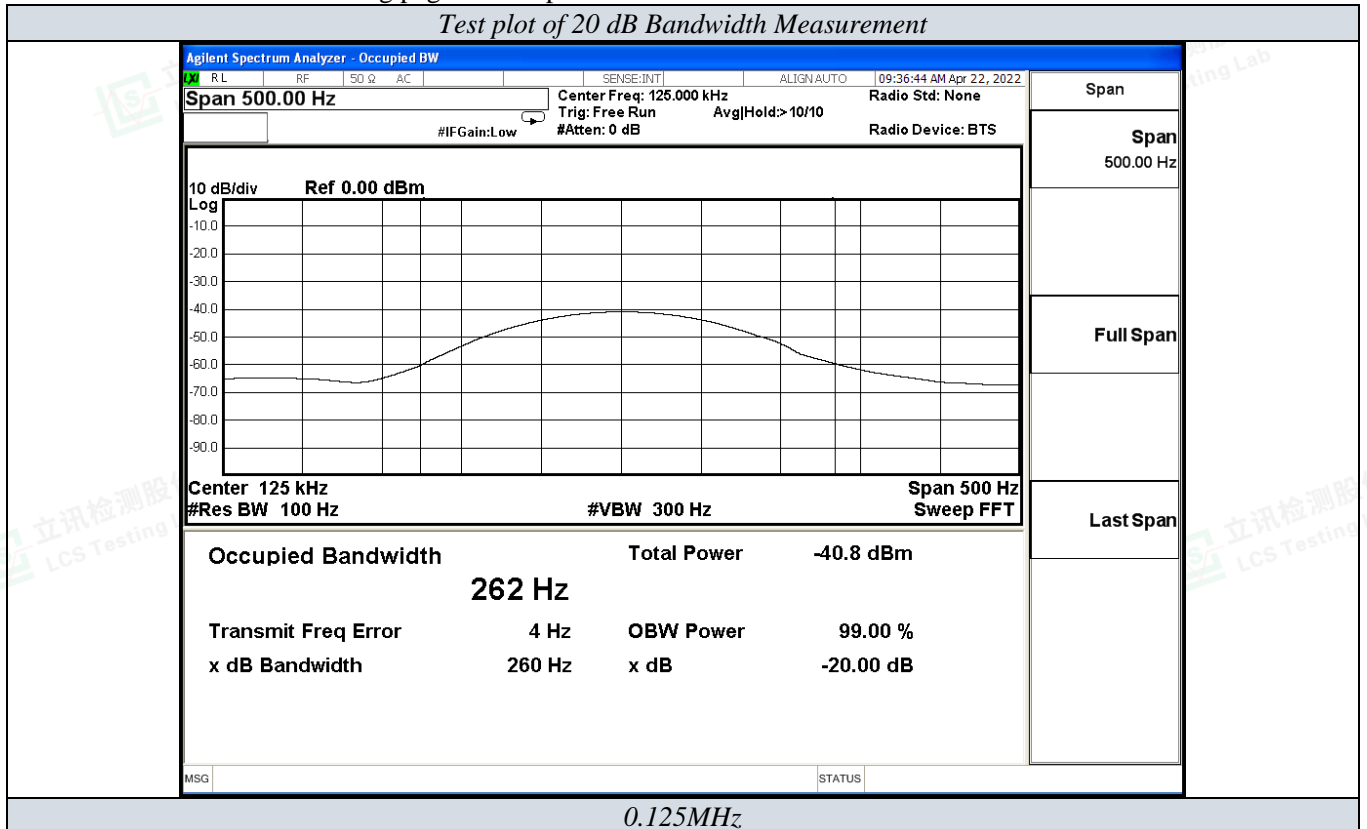



9. PHOTOGRAPHS OF TEST SETUP

Please refer to separated files for Test Setup Photos of the EUT.

10. EXTERNAL PHOTOGRAPHS OF THE EUT

Please refer to separated files for External Photos of the EUT.

11. INTERNAL PHOTOGRAPHS OF THE EUT

Please refer to separated files for Internal Photos of the EUT.

-----THE END OF REPORT-----



Shenzhen LCS Compliance Testing Laboratory Ltd.

Add: 101, 201 Bldg A & 301 Bldg C, Juji Industrial Park Yabianxueziwei, Shajing Street, Baoan District, Shenzhen, 518000, China

Tel: +(86) 0755-82591330 | E-mail: webmaster@lcs-cert.com | Web: www.lcs-cert.com

Scan code to check authenticity