

# FCC TEST REPORT

## FCC ID:2A6NT-VGEA810

## IC:28474-VGEA810

Report Number..... : ZKT-220718L5034-2

Date of Test..... Jul. 01, 2022 to Aug. 22, 2022

Date of issue..... : Aug. 24, 2022

Total number of pages..... 48

Test Result ..... : PASS

Testing Laboratory..... : Shenzhen ZKT Technology Co., Ltd.

Address ..... : 1/F, No. 101, Building B, No. 6, Tangwei Community Industrial Avenue, Fuhai Street, Bao'an District, Shenzhen, China

Applicant's name ..... : Cerwin-Vega, Inc.

Address ..... : 3761 S. Hill Street Los Angeles, CA 90007

Manufacturer's name ..... : Cerwin-Vega, Inc.

Address ..... : 3761 S. Hill Street Los Angeles, CA 90007

Test specification:

Standard..... : FCC CFR Title 47 Part 15 Subpart C Section 15.247  
RSS-247 Issue 2: February 2017  
RSS-GEN, Issue 5: March 2019  
ANSI C63.10:2013

Test procedure..... : /

Non-standard test method ..... : N/A

**Test Report Form No.....** : TRF-EL-111\_V0**Test Report Form(s) Originator.....** : ZKT Testing**Master TRF .....** : Dated: 2021-04-22

This device described above has been tested by ZKT, and the test results show that the equipment under test (EUT) is in compliance with the FCC requirements. And it is applicable only to the tested sample identified in the report.

This report shall not be reproduced except in full, without the written approval of ZKT, this document may be altered or revised by ZKT, personal only, and shall be noted in the revision of the document.

Product name..... : Subwoofer

Trademark ..... : 

Model/Type reference..... : VEGA8S-HUB, VEGA10S-HUB

Ratings..... : AC 100V-240V, 50/60Hz

**Testing procedure and testing location:**

**Testing Laboratory**.....: **Shenzhen ZKT Technology Co., Ltd.**

**Address**.....: 1/F, No. 101, Building B, No. 6, Tangwei Community  
Industrial Avenue, Fuhai Street, Bao'an District,  
Shenzhen, China

**Tested by (name + signature)**.....: Alen He

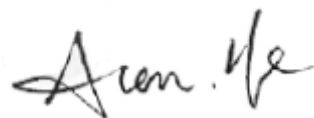

**Reviewer (name + signature)**.....: Joe Liu



**Approved (name + signature)**.....: Lake Xie



## Table of Contents

Page

<b>1.VERSION .....</b>	<b>5</b>
<b>2.SUMMARY OF TEST RESULTS .....</b>	<b>6</b>
2.1 TEST FACILITY .....	7
2.2 MEASUREMENT UNCERTAINTY .....	7
<b>3. GENERAL INFORMATION .....</b>	<b>8</b>
3.1 GENERAL DESCRIPTION OF EUT .....	8
3.2 DESCRIPTION OF TEST MODES .....	9
3.3 BLOCK DIGRAM SHOWING THE CONFIGURATION OF SYSTEM TESTED .....	9
3.4 DESCRIPTION OF SUPPORT UNITS(CONDUCTED MODE) .....	9
3.5 EQUIPMENTS LIST FOR ALL TEST ITEMS .....	10
<b>4. EMC EMISSION TEST .....</b>	<b>11</b>
4.1 CONDUCTED EMISSION MEASUREMENT .....	11
4.1.1 POWER LINE CONDUCTED EMISSION Limits .....	11
4.1.2 TEST PROCEDURE .....	11
4.1.3 DEVIATION FROM TEST STANDARD .....	11
4.1.4 TEST SETUP .....	12
4.1.5 EUT OPERATING CONDITIONS .....	12
4.1.6 TEST RESULTS .....	13
4.2 RADIATED EMISSION MEASUREMENT .....	17
4.2.1 RADIATED EMISSION LIMITS .....	17
4.2.2 TEST PROCEDURE .....	18
4.2.3 DEVIATION FROM TEST STANDARD .....	18
4.2.4 TEST SETUP .....	18
4.2.5 EUT OPERATING CONDITIONS .....	19
<b>5.RADIATED BAND EMISSION MEASUREMENT .....</b>	<b>26</b>
5.1 TEST REQUIREMENT: .....	26
5.2 TEST PROCEDURE .....	26
5.3 DEVIATION FROM TEST STANDARD .....	26
5.4 TEST SETUP .....	27
5.5 EUT OPERATING CONDITIONS .....	27
5.6 TEST RESULT .....	28
<b>6.POWER SPECTRAL DENSITY TEST .....</b>	<b>29</b>
6.1 APPLIED PROCEDURES / LIMIT .....	29
6.2 TEST PROCEDURE .....	29
6.3 DEVIATION FROM STANDARD .....	29
6.4 TEST SETUP .....	29

Table of Contents	Page
6.5 EUT OPERATION CONDITIONS .....	29
6.6 TEST RESULTS .....	30
<b>7. CHANNEL BANDWIDTH .....</b>	<b>32</b>
7.1 APPLIED PROCEDURES / LIMIT .....	32
7.2 TEST PROCEDURE .....	32
7.3 DEVIATION FROM STANDARD .....	32
7.4 TEST SETUP .....	32
7.5 EUT OPERATION CONDITIONS .....	32
7.6 TEST RESULTS .....	33
<b>8. PEAK OUTPUT POWER TEST .....</b>	<b>37</b>
8.1 APPLIED PROCEDURES / LIMIT .....	37
8.2 TEST PROCEDURE .....	37
8.3 DEVIATION FROM STANDARD .....	37
8.4 TEST SETUP .....	37
8.5 EUT OPERATION CONDITIONS .....	37
8.6 TEST RESULTS .....	38
<b>9. CONDUCTED BAND EDGE AND SPURIOUS EMISSION .....</b>	<b>40</b>
9.1 APPLICABLE STANDARD .....	40
9.2 TEST PROCEDURE .....	40
9.3 DEVIATION FROM STANDARD .....	40
9.4 TEST SETUP .....	40
9.5 EUT OPERATION CONDITIONS .....	40
<b>10. ANTENNA REQUIREMENT .....</b>	<b>47</b>
<b>11. TEST SETUP PHOTO .....</b>	<b>48</b>
<b>12. EUT CONSTRUCTIONAL DETAILS .....</b>	<b>48</b>

**1.VERSION**

Report No.	Version	Description	Approved
ZKT-220718L5034-2	Rev.01	Initial issue of report	Aug. 24, 2022

## 2.SUMMARY OF TEST RESULTS

Test procedures according to the technical standards:

FCC Part15 (15.247) , Subpart C RSS-247 Issue 2: February 2017			
Standard Section	Test Item	Judgment	Remark
FCC part 15.203/15.247 (c) RSS-Gen 6.8	Antenna requirement	PASS	
FCC part 15.207 RSS-Gen 8.8	AC Power Line Conducted Emission	PASS	
FCC part 15.247 (b)(3) RSS-247.5.4(4)	Conducted Peak Output Power	PASS	
FCC part 15.247 (a)(2) RSS-247 [5.2(1)]	6dB Bandwidth& 99% OCB	PASS	
FCC part 15.247 (e) RSS-247 [5.2(2)]	Power Spectral Density	PASS	
FCC part 15.247(d) RSS-247 5.5	Conducted Unwanted emissions and Bandedge	PASS	
FCC part 15.205/15.209 RSS-Gen 8.9 RSS-Gen 8.10	Radiated Emission and Restricted Bands	PASS	

NOTE:

(1)" N/A" denotes test is not applicable in this Test Report

## 2.1 TEST FACILITY

Shenzhen ZKT Technology Co., Ltd.  
Add. : 1/F, No. 101, Building B, No. 6, Tangwei Community Industrial Avenue, Fuhai Street, Bao'an District, Shenzhen, China

FCC Test Firm Registration Number: 692225  
Designation Number: CN1299  
IC Registered No.: 27033  
Test lab CAB identifier:CN0110

## 2.2 MEASUREMENT UNCERTAINTY

The reported uncertainty of measurement  $y \pm U$  · where expanded uncertainty U is based on a standard uncertainty multiplied by a coverage factor of  $k=2$  · providing a level of confidence of approximately 95 % ·

No.	Item	Uncertainty
1	Conducted Emission Test	$\pm 1.38\text{dB}$
2	RF power conducted	$\pm 0.16\text{dB}$
3	Spurious emissions conducted	$\pm 0.21\text{dB}$
4	All emissions radiated(<1G)	$\pm 4.68\text{dB}$
5	All emissions radiated(>1G)	$\pm 4.89\text{dB}$
6	Temperature	$\pm 0.5^\circ\text{C}$
7	Humidity	$\pm 2\%$

### 3. GENERAL INFORMATION

#### 3.1 GENERAL DESCRIPTION OF EUT

Product Name:	Subwoofer
Model No.:	VEGA10S-HUB
Sample ID:	ZKT220718L5034-1#
Serial No.:	VEGA8S-HUB
Model Different.:	VEGA8S and VEGA10S power boards are the same, and the power amplifier PCB board is the same. Differences: 1. Due to different power, VEGA8S is equipped with one less power amplifier IC than VEGA10S. 2. The sizes of wooden cases are different.
HVIN:	VEGA10S-HUB, VEGA8S-HUB
Hardware Version:	V1.0
Software Version:	V1.0
Sample(s) Status:	Engineer sample
Operation Frequency:	2403.5MHz~2477.3MHz
Channel Numbers:	49
Modulation Type:	FSK
Antenna Type:	Bowtie Dipole
Antenna gain:	2.3dBi
Power supply:	AC 100V-240V, 50/60Hz

Operation Frequency each of channel							
Channel	Frequency	Channel	Frequency	Channel	Frequency	Channel	Frequency
00	2403.5MHz	01	2405.1MHz	02	2406.6MHz	03	2408.1MHz
04	2409.7MHz	05	2411.2MHz	06	2412.8MHz	07	2414.3MHz
08	2415.8MHz	09	2417.4MHz	10	2418.9MHz	11	2420.4MHz
12	2422.0MHz	13	2423.5MHz	14	2425.1MHz	15	2426.6MHz
16	2428.1MHz	17	2429.7MHz	18	2431.2MHz	19	2432.7MHz
20	2434.3MHz	21	2435.8MHz	22	2437.4MHz	23	2438.9MHz
24	2440.4MHz	25	2442.0MHz	26	2443.5MHz	27	2445.0MHz
28	2446.6MHz	29	2448.1MHz	30	2449.6MHz	31	2451.2MHz
32	2452.7MHz	33	2454.3MHz	34	2455.8MHz	35	2457.3MHz
36	2458.9MHz	37	2460.4MHz	38	2461.9MHz	39	2463.5MHz
40	2465.0MHz	41	2466.6MHz	42	2468.1MHz	43	2469.6MHz
44	2471.2MHz	45	2472.7MHz	46	2474.2MHz	47	2475.8MHz
48	2477.3MHz						

**Note:**

In section 15.31(m), regards to the operating frequency range over 10 MHz, the Lowest frequency,



the middle frequency, and the highest frequency of channel were selected to perform the test, and the selected channel see below:

Channel	Frequency
The lowest channel	2403.5MHz
The middle channel	2440.4MHz
The Highest channel	2477.3MHz

### 3.2 DESCRIPTION OF TEST MODES

Transmitting mode	Keep the EUT in continuously transmitting mode
Remark: During the test, the test voltage was tuned from 85% to 115% of the nominal rated supply voltage, and found that the worst case was under the nominal rated supply condition. So the report just shows that condition's data.	

Test Software	emi-test-v0.0
Power level setup	<7dBm

### 3.3 BLOCK DIGRAM SHOWING THE CONFIGURATION OF SYSTEM TESTED

Conducted Emission

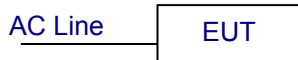

Radiated Emission

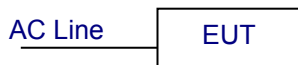

Conducted Spurious



### 3.4 DESCRIPTION OF SUPPORT UNITS(CONDUCTED MODE)

The EUT has been tested as an independent unit together with other necessary accessories or support units. The following support units or accessories were used to form a representative test configuration during the tests.

Item	Equipment	Mfr/Brand	Model/Type No.	Series No.	Note
E-1	Subwoofer		VEGA10S-HUB, VEGA8S-HUB	N/A	EUT
AE-1	Notebook	lenovo	B40-80	MP07F6JD	AE
Item	Shielded Type	Ferrite Core	Length	Note	

Note:

- (1) The support equipment was authorized by Declaration of Confirmation.
- (2) For detachable type I/O cable should be specified the length in cm in 『Length』 column.

**3.5 EQUIPMENTS LIST FOR ALL TEST ITEMS**
**Radiation & RF Conducted Test equipment**

Item	Equipment	Manufacturer	Type No.	Serial No.	Last calibration	Calibrated until
1	Spectrum Analyzer (9kHz-26.5GHz)	KEYSIGHT	9020A	MY45109572	Sep. 21, 2021	Sep. 20, 2022
2	Spectrum Analyzer (1GHz-40GHz)	Agilent	E4446A	100363	Sep. 21, 2021	Sep. 20, 2022
3	Test Receiver (9kHz-7GHz)	R&S	ESC17	101169	Sep. 21, 2021	Sep. 20, 2022
4	Bilog Antenna (30MHz-1400MHz)	Schwarzbeck	VULB9168	00877	Sep. 21, 2021	Sep. 20, 2022
5	Horn Antenna (1GHz-18GHz)	SCHWARZBEC K	BBHA9120D	1541	Sep. 21, 2021	Sep. 20, 2022
6	Horn Antenna (18GHz-40GHz)	A.H. System	SAS-574	588	Sep. 21, 2021	Sep. 20, 2022
7	Amplifier (30-1000MHz)	EM Electronics	EM330 Amplifier	N/A	Sep. 21, 2021	Sep. 20, 2022
8	Amplifier (1GHz-40GHz)	QUANJUDA	DLE-161	097	Sep. 21, 2021	Sep. 20, 2022
9	Loop Antenna (9KHz-30MHz)	SCHWARZBEC K	FMZB1519B	014	Sep. 21, 2021	Sep. 20, 2022
10	RF cables1 (9kHz-30MHz)	N/A	9kHz-30MHz	N/A	Sep. 21, 2021	Sep. 20, 2022
11	RF cables2 (30MHz-1GHz)	N/A	30MHz-1GHz	N/A	Sep. 21, 2021	Sep. 20, 2022
12	RF cables3 (1GHz-40GHz)	N/A	1GHz-40GHz	N/A	Sep. 21, 2021	Sep. 20, 2022
13	CMW500 Test	R&S	CMW500	106504	Sep. 21, 2021	Sep. 20, 2022
14	ESG Signal Generator	Agilent	E4421B	GB40051203	Sep. 21, 2021	Sep. 20, 2022
15	Signal Generator	Agilent	N5182A	MY47420215	Sep. 21, 2021	Sep. 20, 2022
16	Power Meter	Anritsu	ML2495A	N/A	Sep. 21, 2021	Sep. 20, 2022
17	D.C. Power Supply	LongWei	TPR-6405D	\	\	\
18	Software	Audix	E3	6.101223a	\	\

**Conduction Test equipment**

Item	Kind of Equipment	Manufacturer	Type No.	Serial No.	Last calibration	Calibrated until
1	LISN	R&S	ENV216	101471	Sep. 21, 2021	Sep. 20, 2022
2	LISN	CYBERTEK	EM5040A	E1850400149	Sep. 21, 2021	Sep. 20, 2022
3	Test Cable	N/A	C01	N/A	Sep. 21, 2021	Sep. 20, 2022
4	Test Cable	N/A	C02	N/A	Sep. 21, 2021	Sep. 20, 2022
5	EMI Test Receiver	R&S	ESRP3	101946	Sep. 21, 2021	Sep. 20, 2022
6	Absorbing Clamp	DZ	ZN23201	N/A	Sep. 21, 2021	Sep. 20, 2022
7	Software	Audix	E3	6.101223a	\	\

## 4. EMC EMISSION TEST

### 4.1 CONDUCTED EMISSION MEASUREMENT

Test Requirement:	FCC Part15 C Section 15.207&RSS-Gen 8.9
Test Method:	ANSI C63.10:2013 and RSS-Gen
Test Frequency Range:	150KHz to 30MHz
Receiver setup:	RBW=9KHz, VBW=30KHz, Sweep time=auto

#### 4.1.1 POWER LINE CONDUCTED EMISSION Limits

FREQUENCY (MHz)	Limit (dBuV)		Standard
	Quas-peak	Average	
0.15 -0.5	66 - 56 *	56 - 46 *	FCC
0.50 -5.0	56.00	46.00	FCC
5.0 -30.0	60.00	50.00	FCC

Note:

(1) \*Decreases with the logarithm of the frequency.

#### 4.1.2 TEST PROCEDURE

- a. The EUT was placed 0.8 meters from the horizontal ground plane with EUT being connected to the power mains through a line impedance stabilization network (LISN). All other support equipments powered from additional LISN(s). The LISN provide 50 Ohm/ 50uH of coupling impedance for the measuring instrument.
- b. Interconnecting cables that hang closer than 40 cm to the ground plane shall be folded back and forth in the center forming a bundle 30 to 40 cm long.
- c. I/O cables that are not connected to a peripheral shall be bundled in the center. The end of the cable may be terminated, if required, using the correct terminating impedance. The overall length shall not exceed 1 m.
- d. LISN at least 80 cm from nearest part of EUT chassis.
- e. For the actual test configuration, please refer to the related Item –EUT Test Photos.

#### 4.1.3 DEVIATION FROM TEST STANDARD

No deviation

#### 4.1.4 TEST SETUP

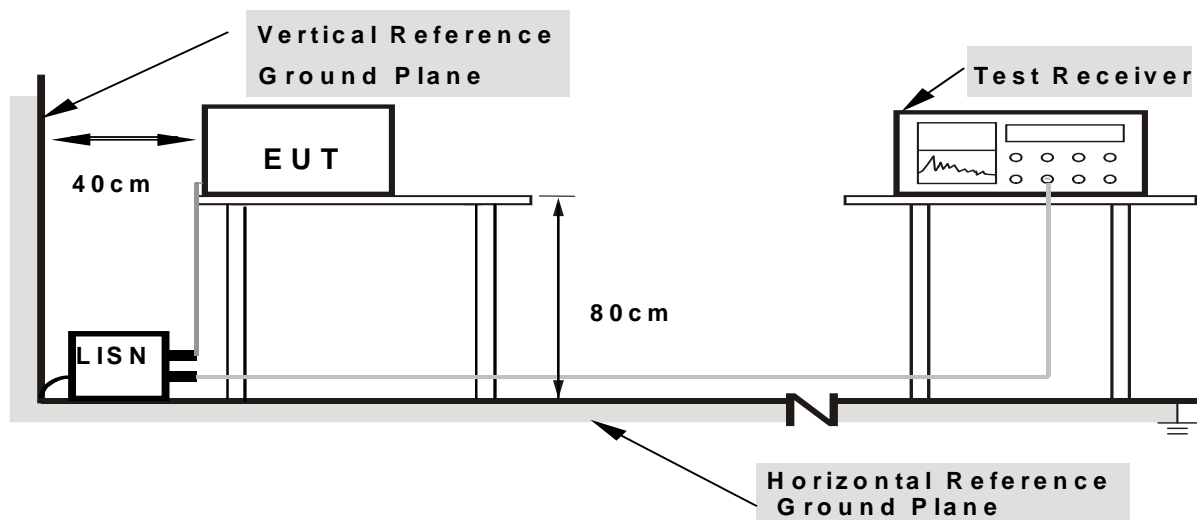

- Note:**
1. Support units were connected to second LISN.
  2. Both of LISNs (AMN) are 80 cm from EUT and at least 80 cm from other units and other metal planes

#### 4.1.5 EUT OPERATING CONDITIONS

The EUT was configured for testing in a typical fashion (as a customer would normally use it). The EUT has been programmed to continuously transmit during test. This operating condition was tested and used to collect the included data.

We pretest AC 120V and AC 230V, the worst voltage was AC 120V and the data recording in the report.

**4.1.6 TEST RESULTS**

Temperature :	26°C	Relative Humidity:	54%
Pressure :	101kPa	Phase :	L
Test Voltage :	AC 120V/60Hz	Test model :	VEGA10S-HUB
Test Mode:	Transmitting mode of FSK 2403.5MHz		

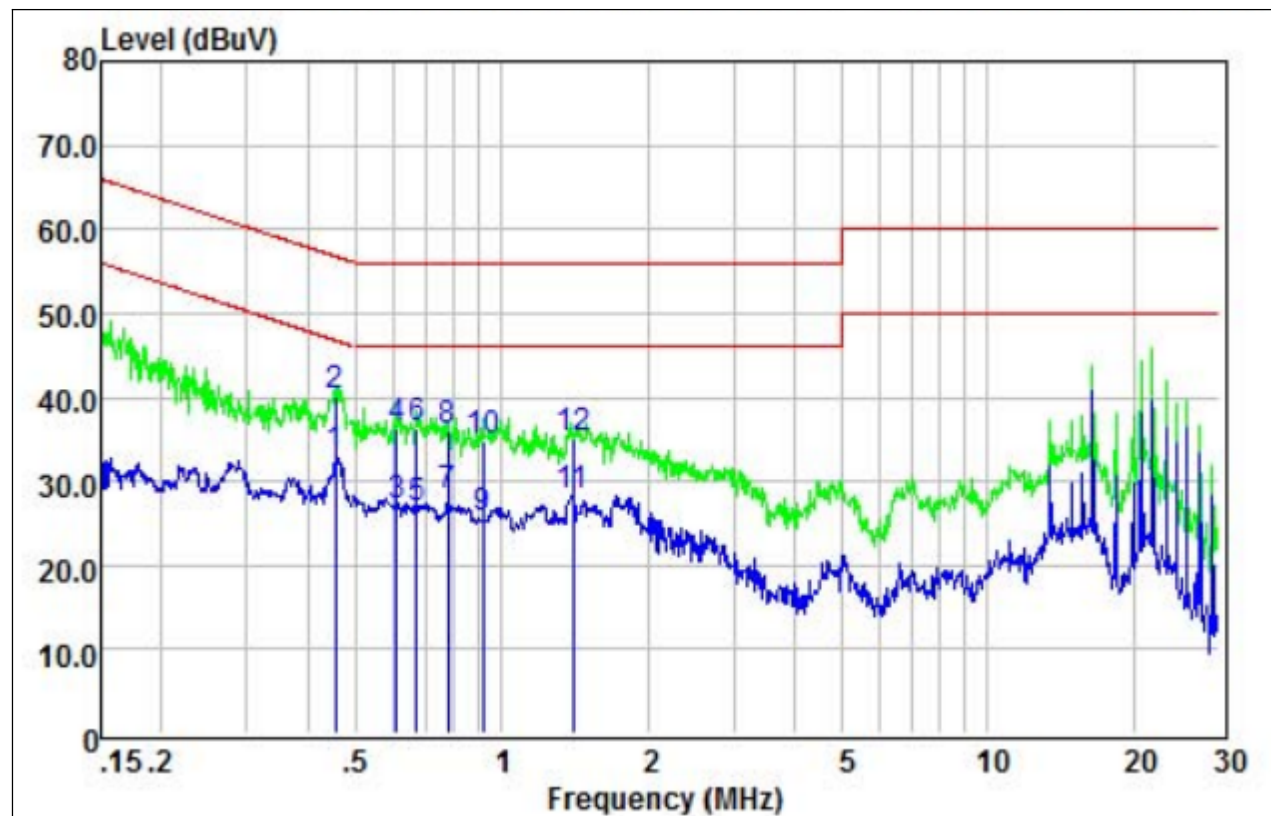

	Freq	Read Level	LISN Factor	Cable Loss	Level	Limit Line	Over Limit	Remark
	MHz	dBuV	dB	dB	dBuV	dBuV	dB	
1	0.46	23.25	9.68	0.05	32.98	46.76	-13.78	Average
2	0.46	30.35	9.68	0.05	40.08	56.76	-16.68	QP
3	0.61	17.50	9.66	0.05	27.21	46.00	-18.79	Average
4	0.61	26.51	9.66	0.05	36.22	56.00	-19.78	QP
5	0.67	17.00	9.65	0.05	26.70	46.00	-19.30	Average
6	0.67	26.57	9.65	0.05	36.27	56.00	-19.73	QP
7	0.78	18.49	9.63	0.05	28.17	46.00	-17.83	Average
8	0.78	26.16	9.63	0.05	35.84	56.00	-20.16	QP
9	0.92	15.99	9.62	0.06	25.67	46.00	-20.33	Average
10	0.92	25.15	9.62	0.06	34.83	56.00	-21.17	QP
11	1.40	18.58	9.60	0.06	28.24	46.00	-17.76	Average
12	1.40	25.57	9.60	0.06	35.23	56.00	-20.77	QP

**Notes:**

1. An initial pre-scan was performed on the line and neutral lines with peak detector.
2. Quasi-Peak and Average measurement were performed at the frequencies with maximized peak emission.
3. Measurement Level = Reading level + Correct Factor

Temperature :	26°C	Relative Humidity:	54%
Pressure :	101kPa	Phase :	N
Test Voltage :	AC 120V/60Hz	Test model :	VEGA10S-HUB
Test Mode:	Transmitting mode of FSK 2403.5MHz		

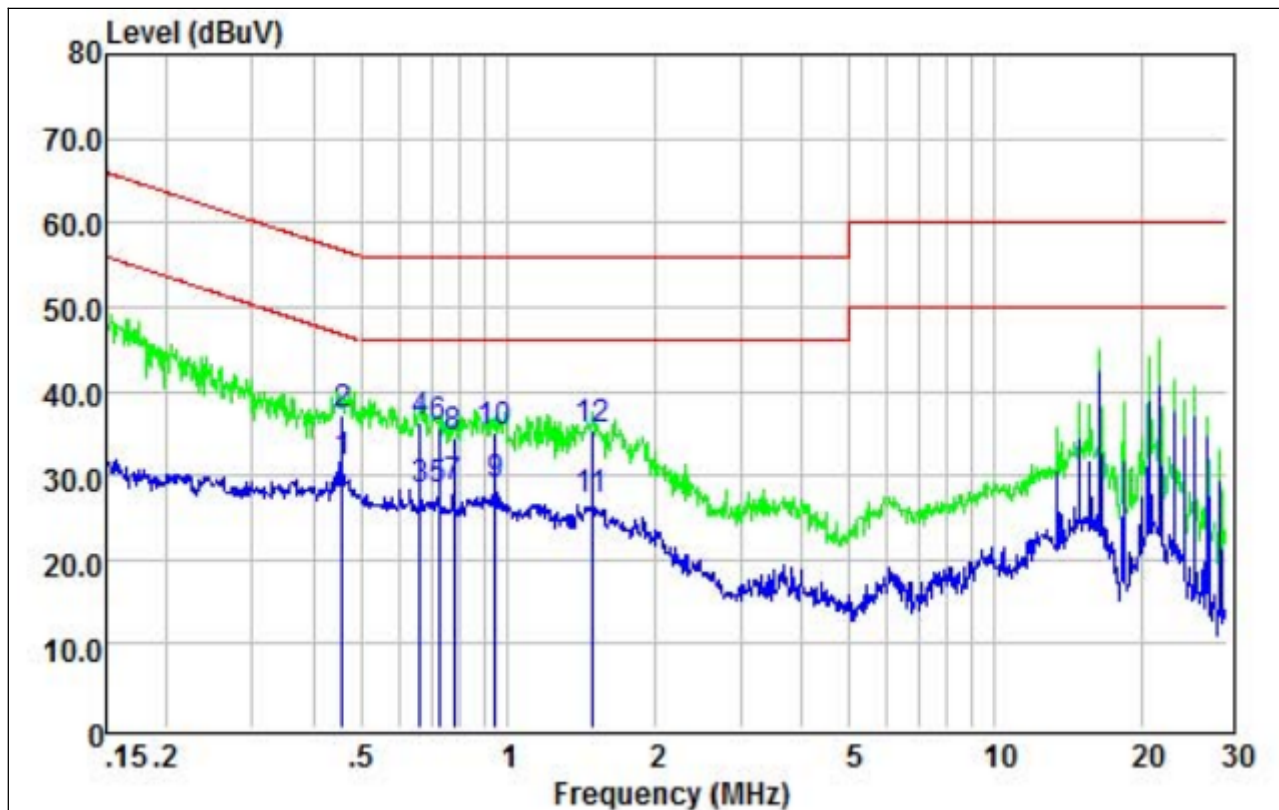

	Read Freq	Read Level	LISN Factor	Cable Loss	Level	Limit Line	Over Limit	Remark
	MHz	dBuV	dB	dB	dBuV	dBuV	dB	
1	0.46	21.89	9.63	0.05	31.57	46.71	-15.14	Average
2	0.46	27.54	9.63	0.05	37.22	56.71	-19.49	QP
3	0.66	18.65	9.63	0.05	28.33	46.00	-17.67	Average
4	0.66	26.59	9.63	0.05	36.27	56.00	-19.73	QP
5	0.72	18.58	9.63	0.05	28.26	46.00	-17.74	Average
6	0.72	26.05	9.63	0.05	35.73	56.00	-20.27	QP
7	0.78	18.91	9.63	0.05	28.59	46.00	-17.41	Average
8	0.78	24.68	9.63	0.05	34.36	56.00	-21.64	QP
9	0.94	19.15	9.63	0.06	28.84	46.00	-17.16	Average
10	0.94	25.53	9.63	0.06	35.22	56.00	-20.78	QP
11	1.50	17.55	9.60	0.06	27.21	46.00	-18.79	Average
12	1.50	25.87	9.60	0.06	35.53	56.00	-20.47	QP

Notes:

1. An initial pre-scan was performed on the line and neutral lines with peak detector.
2. Quasi-Peak and Average measurement were performed at the frequencies with maximized peak emission.
3. Measurement Level = Reading level + Correct Factor

Temperature :	26°C	Relative Humidity:	54%
Pressure :	101kPa	Phase :	L
Test Voltage :	AC 120V/60Hz	Test model :	VEGA8S-HUB

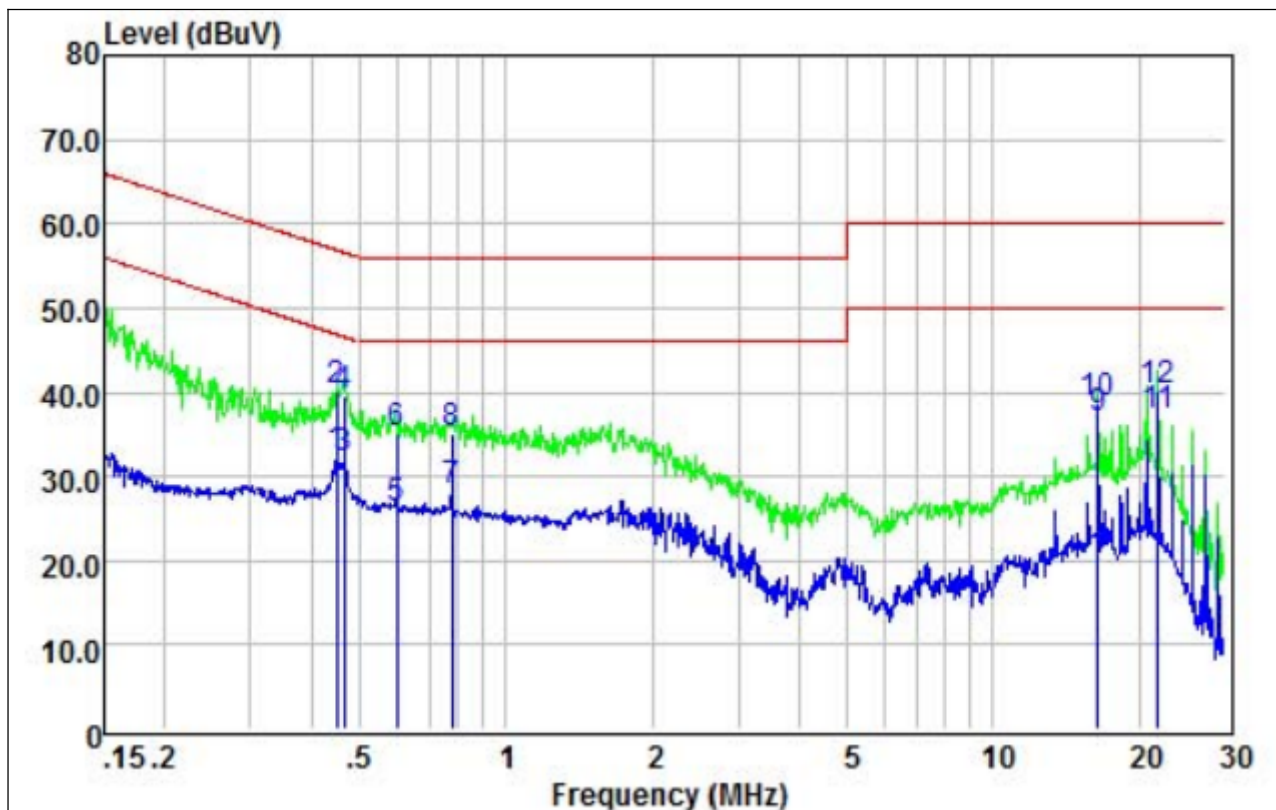

	Read Freq	Read Level	LISN Factor	Cable Loss	Level	Limit Line	Over Limit	Remark
	MHz	dBuV	dB	dB	dBuV	dBuV	dB	
1	0.45	22.68	9.68	0.05	32.41	46.89	-14.48	Average
2	0.45	30.37	9.68	0.05	40.10	56.89	-16.79	QP
3	0.47	22.51	9.68	0.05	32.24	46.58	-14.34	Average
4	0.47	29.96	9.68	0.05	39.69	56.58	-16.89	QP
5	0.60	16.32	9.66	0.05	26.03	46.00	-19.97	Average
6	0.60	25.50	9.66	0.05	35.21	56.00	-20.79	QP
7	0.78	18.44	9.63	0.05	28.12	46.00	-17.88	Average
8	0.78	25.27	9.63	0.05	34.95	56.00	-21.05	QP
9	16.49	27.33	9.56	0.10	36.99	50.00	-13.01	Average
10	16.49	28.88	9.56	0.10	38.54	60.00	-21.46	QP
11	21.83	27.40	9.67	0.10	37.17	50.00	-12.83	Average
12	21.83	30.33	9.67	0.10	40.10	60.00	-19.90	QP

Notes:

1. An initial pre-scan was performed on the line and neutral lines with peak detector.
2. Quasi-Peak and Average measurement were performed at the frequencies with maximized peak emission.
3. Measurement Level = Reading level + Correct Factor
4. The test data shows only the worst case FSK mode

Temperature :	26°C	Relative Humidity:	54%
Pressure :	101kPa	Phase :	N
Test Voltage :	AC 120V/60Hz	Test model :	VEGA8S-HUB

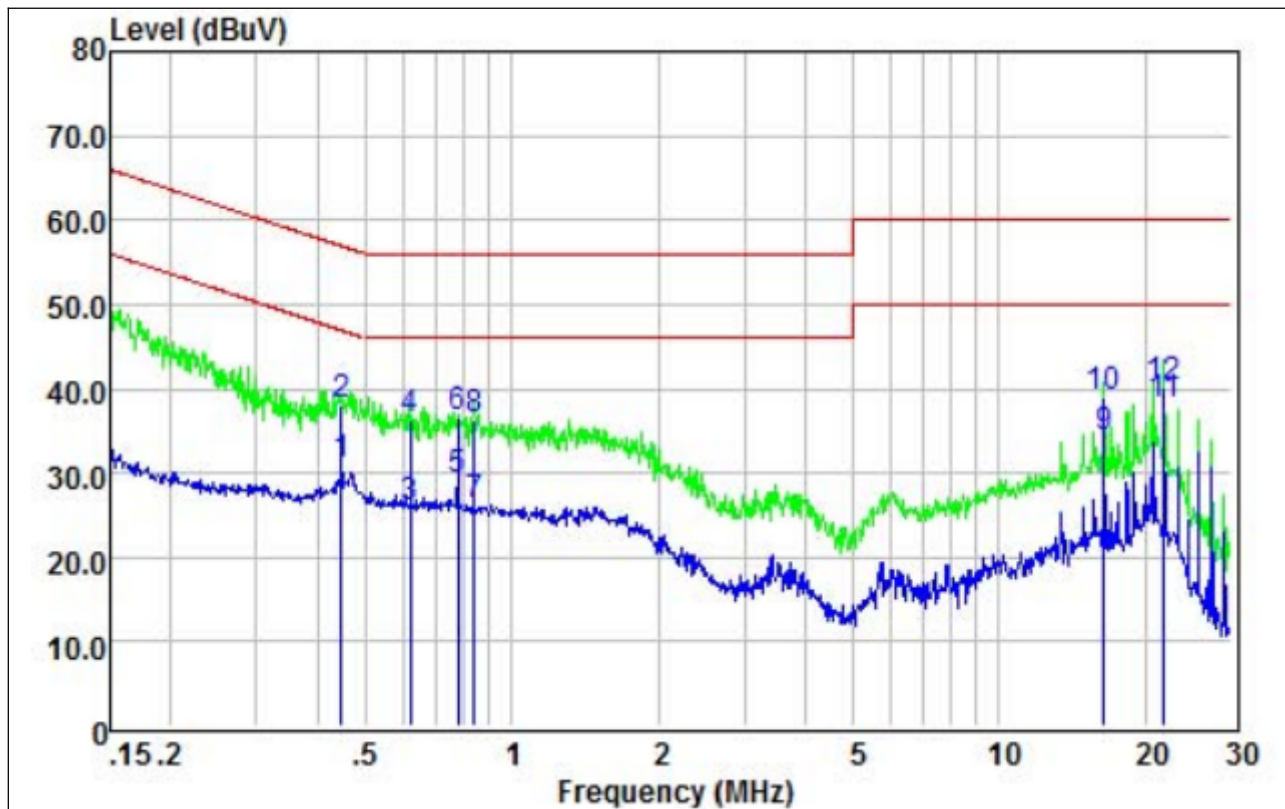

	Read Freq	Read Level	LISN Factor	Cable Loss	Level	Limit Line	Over Limit	Remark
	MHz	dBuV	dB	dB	dBuV	dBuV	dB	
1	0.45	21.38	9.62	0.05	31.05	46.93	-15.88	Average
2	0.45	28.43	9.62	0.05	38.10	56.93	-18.83	QP
3	0.62	16.26	9.63	0.05	25.94	46.00	-20.06	Average
4	0.62	26.58	9.63	0.05	36.26	56.00	-19.74	QP
5	0.78	19.42	9.63	0.05	29.10	46.00	-16.90	Average
6	0.78	26.90	9.63	0.05	36.58	56.00	-19.42	QP
7	0.84	16.50	9.63	0.05	26.18	46.00	-19.82	Average
8	0.84	26.49	9.63	0.05	36.17	56.00	-19.83	QP
9	16.49	24.40	9.76	0.10	34.26	50.00	-15.74	Average
10	16.49	29.12	9.76	0.10	38.98	60.00	-21.02	QP
11	21.83	28.08	9.81	0.10	37.99	50.00	-12.01	Average
12	21.83	30.19	9.81	0.10	40.10	60.00	-19.90	QP

Notes:

1. An initial pre-scan was performed on the line and neutral lines with peak detector.
2. Quasi-Peak and Average measurement were performed at the frequencies with maximized peak emission.
3. Measurement Level = Reading level + Correct Factor
4. The test data shows only the worst case FSK mode



**4.2 RADIATED EMISSION MEASUREMENT**

Test Requirement:	FCC Part15 C Section 15.209 and 15.205 RSS-Gen 8.9, RSS-Gen 8.10				
Test Method:	ANSI C63.10:2013 and RSS-Gen				
Test Frequency Range:	9kHz to 25GHz				
Test site:	Measurement Distance: 3m				
Receiver setup:	Frequency	Detector	RBW	VBW	Value
	9KHz-150KHz	Quasi-peak	200Hz	600Hz	Quasi-peak
	150KHz-30MHz	Quasi-peak	9KHz	30KHz	Quasi-peak
	30MHz-1GHz	Quasi-peak	100KHz	300KHz	Quasi-peak
	Above 1GHz	Peak	1MHz	3MHz	Peak
Peak		1MHz	1/T	Average	

**4.2.1 RADIATED EMISSION LIMITS**

Frequencies (MHz)	Field Strength (micorvolts/meter)	Measurement Distance (meters)
0.009~0.490	2400/F(KHz)	300
0.490~1.705	24000/F(KHz)	30
1.705~30.0	30	30
30~88	100	3
88~216	150	3
216~960	200	3
Above 960	500	3

**LIMITS OF RADIATED EMISSION MEASUREMENT**

FREQUENCY (MHz)	Limit (dBuV/m) (at 3M)	
	PEAK	AVERAGE
Above 1000	74	54

**Notes:**

- (1) The limit for radiated test was performed according to FCC PART 15C.
- (2) The tighter limit applies at the band edges.
- (3) Emission level (dBuV/m)=20log Emission level (uV/m).

#### 4.2.2 TEST PROCEDURE

- a. The measuring distance of at 3 m shall be used for measurements at frequency up to 25GHz. For frequencies above 1GHz, any suitable measuring distance may be used.
- b. The EUT was placed on the top of a rotating table 0.8 meters above the ground at a 3 meter semi-chamber test. The table was rotated 360 degrees to determine the position of the highest radiation.
- c. The height of the equipment or of the substitution antenna shall be 0.8m; above 1GHz, the height was 1.5m, the height of the test antenna shall vary between 1 m to 4 m. Both horizontal and vertical polarizations of the antenna are set to make the measurement.
- d. The initial step in collecting conducted emission data is a spectrum analyzer peak detector mode pre-scanning the measurement frequency range. Significant peaks are then marked and then Quasi Peak detector mode re-measured.
- e. If the Peak Mode measured value compliance with and lower than Quasi Peak Mode Limit, the EUT shall be deemed to meet QP Limits and then no additional QP Mode measurement performed.
- f. For the actual test configuration, please refer to the related Item –EUT Test Photos.
- g. For the radiated emission test above 1GHz:  
Place the measurement antenna away from each area of the EUT determined to be a source of emissions at the specified measurement distance, while keeping the measurement antenna aimed at the source of emissions at each frequency of significant emissions, with polarization oriented for maximum response.

The measurement antenna may have to be higher or lower than the EUT, depending on the radiation pattern of the emission and staying aimed at the emission source for receiving the maximum signal. The final measurement antenna elevation shall be that which maximizes the emissions. The measurement antenna elevation for maximum emissions shall be restricted to a range of heights of from 1 m to 4 m above the ground or reference ground plane.

Note:

Both horizontal and vertical antenna polarities were tested and performed pretest to three orthogonal axis. The worst case emissions were reported

#### 4.2.3 DEVIATION FROM TEST STANDARD

No deviation

#### 4.2.4 TEST SETUP

##### (A) Radiated Emission Test-Up Frequency Below 30MHz

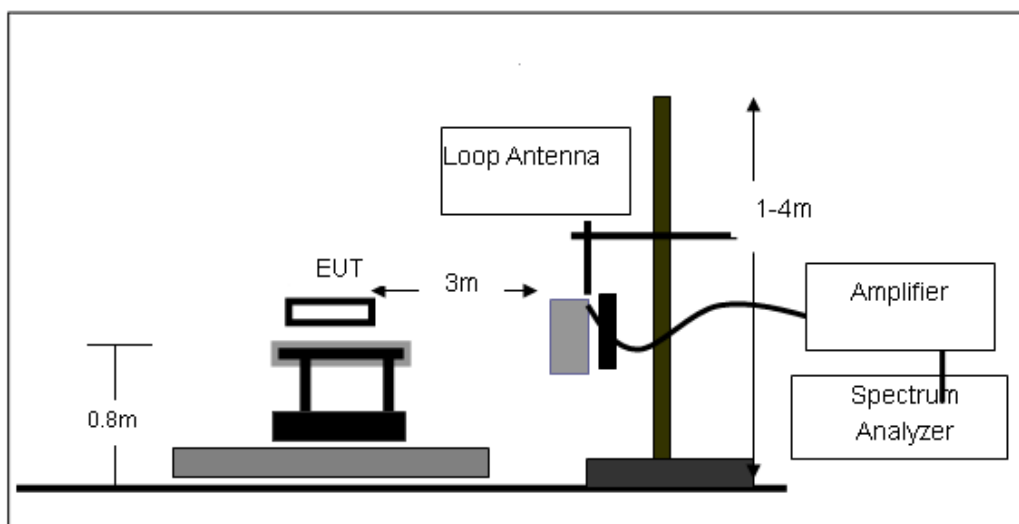

(B) Radiated Emission Test-Up Frequency 30MHz~1GHz

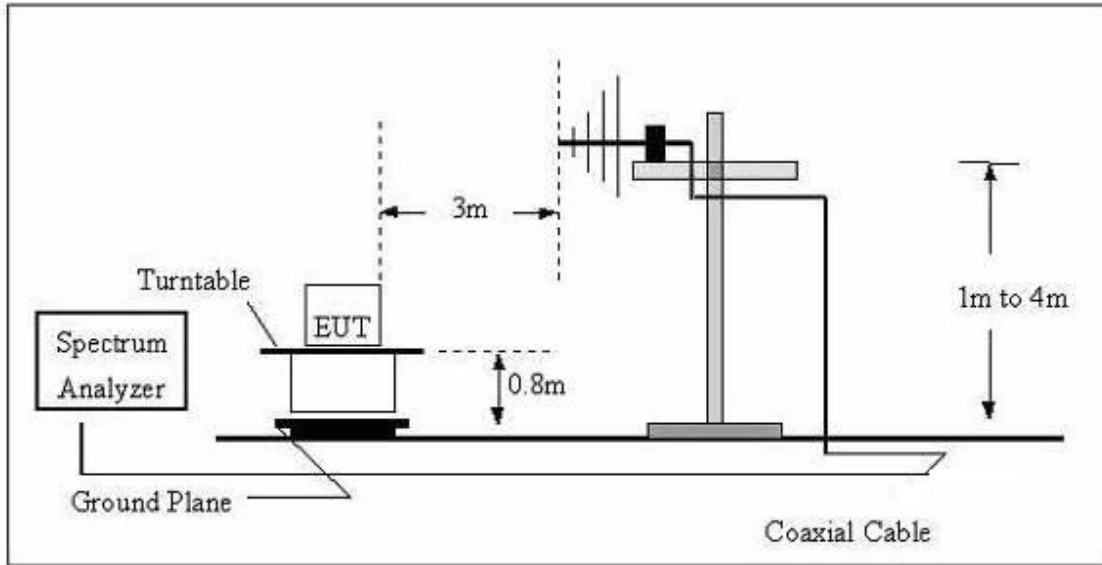

(C) Radiated Emission Test-Up Frequency Above 1GHz

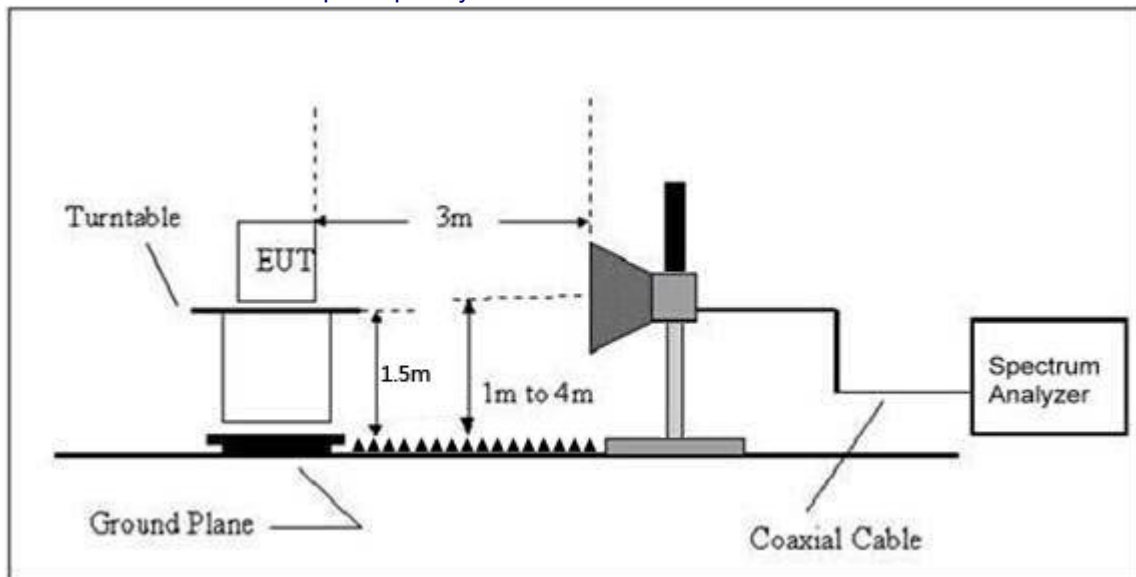

4.2.5 EUT OPERATING CONDITIONS

The EUT tested system was configured as the statements of 2.4 Unless otherwise a special operating condition is specified in the follows during the testing.

4.2.6 TEST RESULTS (Between 9KHz – 30 MHz)

The emission from 9 kHz to 30MHz was pre-tested and found the result was 20dB lower than the limit, and according to 15.31(o) & RSS-Gen 6.13, the test result no need to reported.

Between 30MHz – 1GHz

Temperature:	26°C	Relative Humidity:	54%
Pressure:	101 kPa	Polarization:	Horizontal
Test Voltage:	AC 120V/60Hz	Test model :	VEGA10S-HUB
Test Mode:	Transmitting mode of FSK 2403.5MHz		

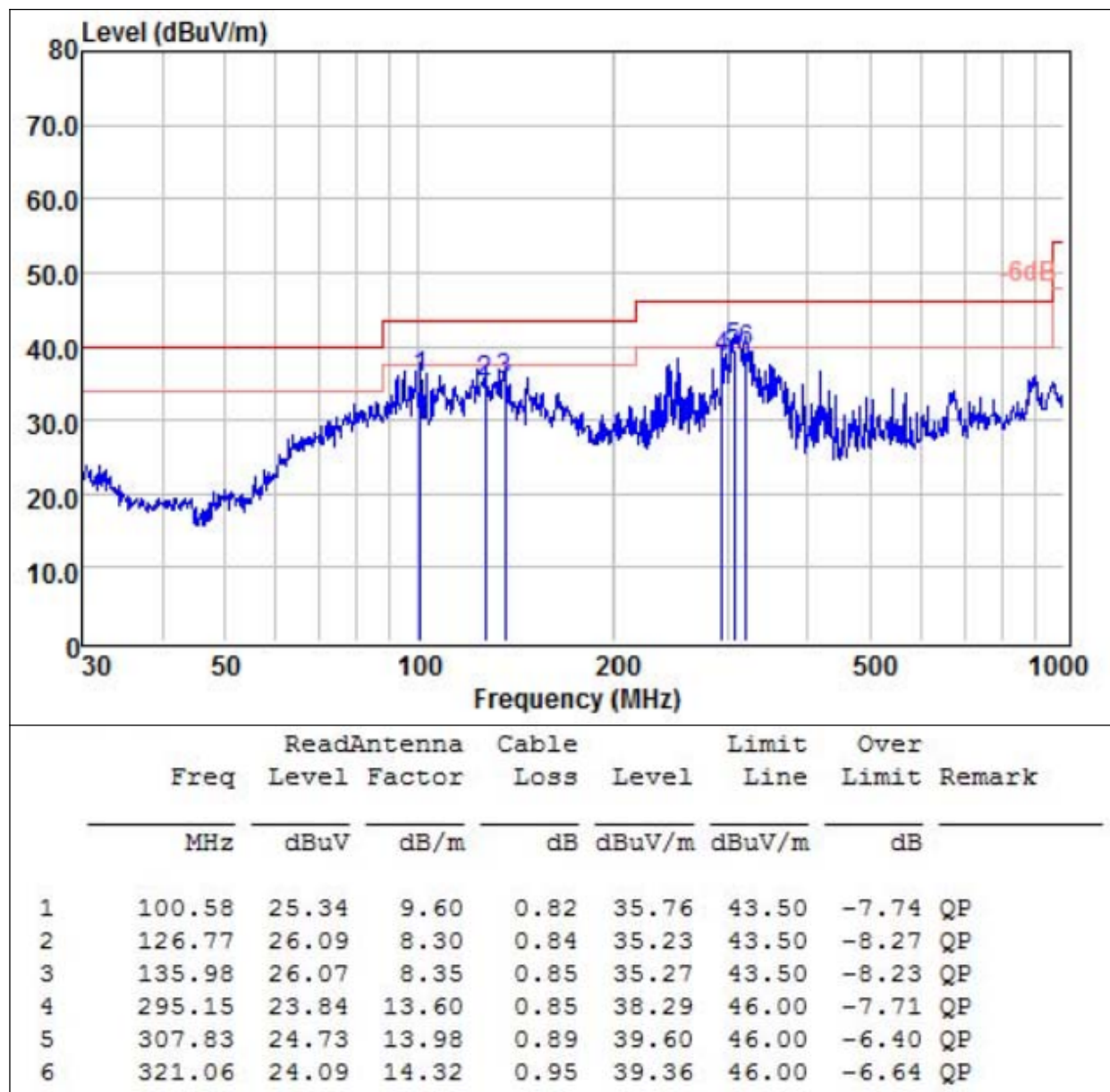

Temperature:	26°C	Relative Humidity:	54%
Pressure:	101kPa	Polarization:	Vertical
Test Voltage:	AC 120V/60Hz	Test model :	VEGA10S-HUB
Test Mode:	Transmitting mode of FSK 2403.5MHz		

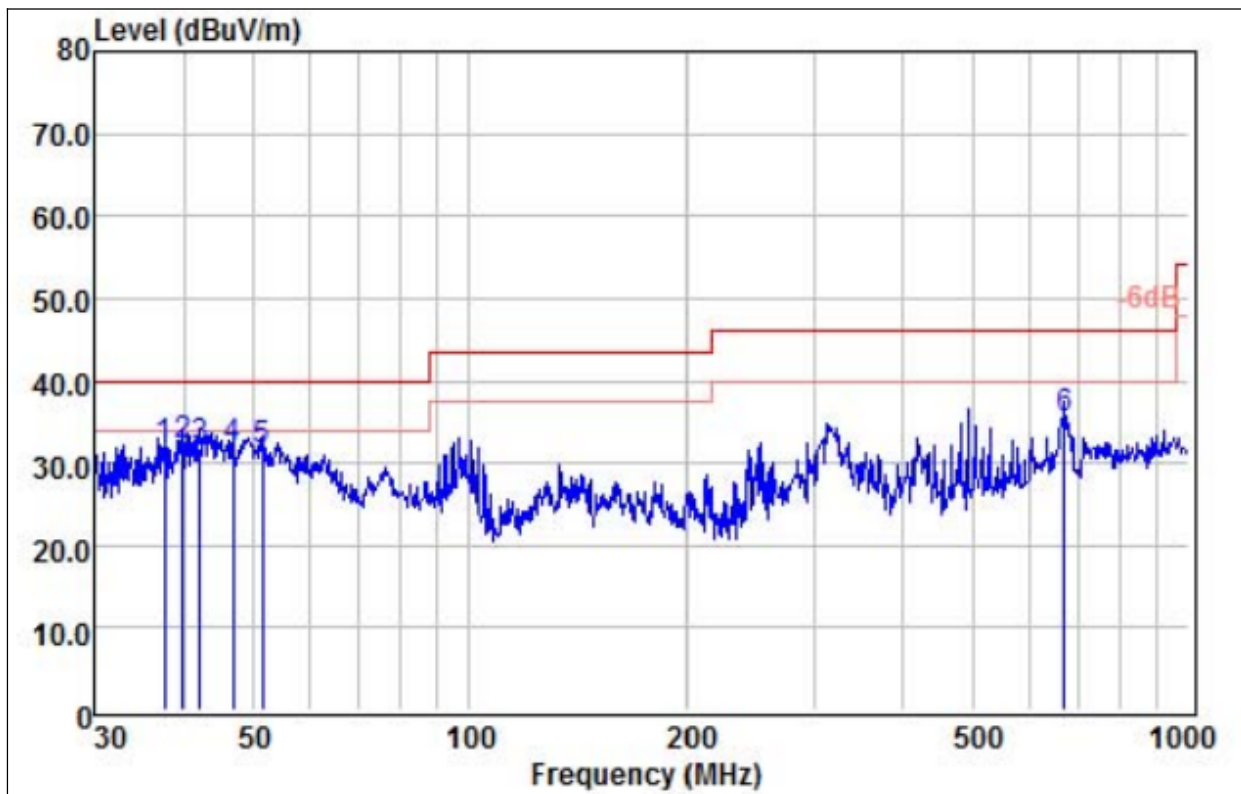

	ReadAntenna	Cable	Limit	Over			
Freq	Level	Factor	Loss	Level	Line	Limit	Remark
MHz	dBuV	dB/m	dB	dBuV/m	dBuV/m	dB	
1	37.55	16.99	14.35	0.35	31.69	40.00	-8.31 QP
2	39.85	18.72	12.99	0.28	31.99	40.00	-8.01 QP
3	42.15	19.52	12.02	0.28	31.82	40.00	-8.18 QP
4	46.83	21.41	10.10	0.27	31.78	40.00	-8.22 QP
5	51.48	22.57	8.58	0.30	31.45	40.00	-8.55 QP
6	670.49	11.65	21.89	1.82	35.36	46.00	-10.64 QP

Remarks:

- 1.Final Level =Receiver Read level + Antenna Factor + Cable Loss
- 2.The emission levels of other frequencies are very lower than the limit and not show in test report.

Temperature:	26°C	Relative Humidity:	54%
Pressure:	101 kPa	Polarization:	Horizontal
Test Voltage:	AC 120V/60Hz	Test model :	VEGA8S-HUB
Test Mode:	Transmitting mode of FSK 2403.5MHz		

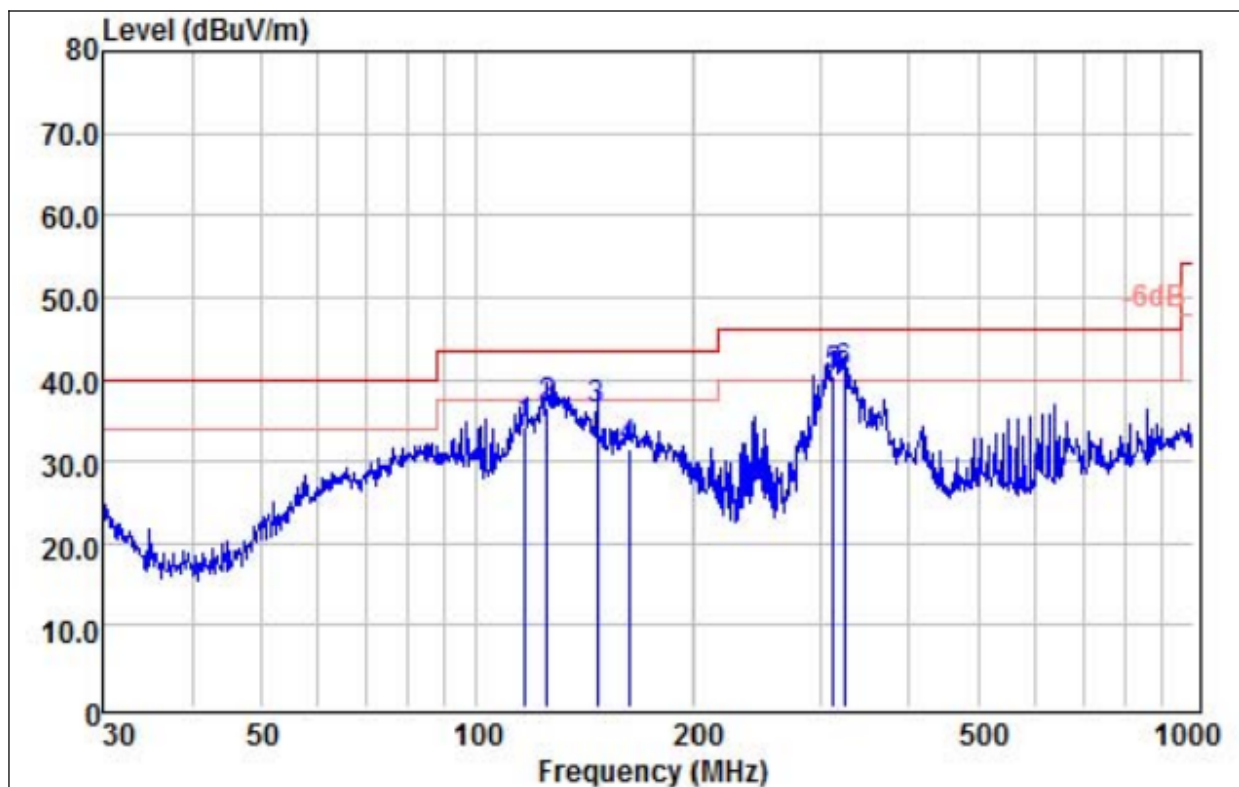

	ReadAntenna	Cable	Limit	Over			
Freq	Level	Factor	Loss	Level	Line	Limit	Remark
MHz	dBuV	dB/m	dB	dBuV/m	dBuV/m	dB	
1	116.95	24.44	8.90	0.83	34.17	43.50	-9.33 QP
2	125.45	27.54	8.30	0.84	36.68	43.50	-6.82 QP
3	147.40	26.82	8.70	0.85	36.37	43.50	-7.13 QP
4	163.18	21.10	9.65	0.86	31.61	43.50	-11.89 QP
5 !	313.28	25.41	14.15	0.92	40.48	46.00	-5.52 QP
6 !	324.46	25.38	14.50	0.97	40.85	46.00	-5.15 QP

Temperature:	26°C	Relative Humidity:	54%
Pressure:	101kPa	Polarization:	Vertical
Test Voltage:	AC 120V/60Hz	Test model :	VEGA8S-HUB
Test Mode:	Transmitting mode of FSK 2403.5MHz		

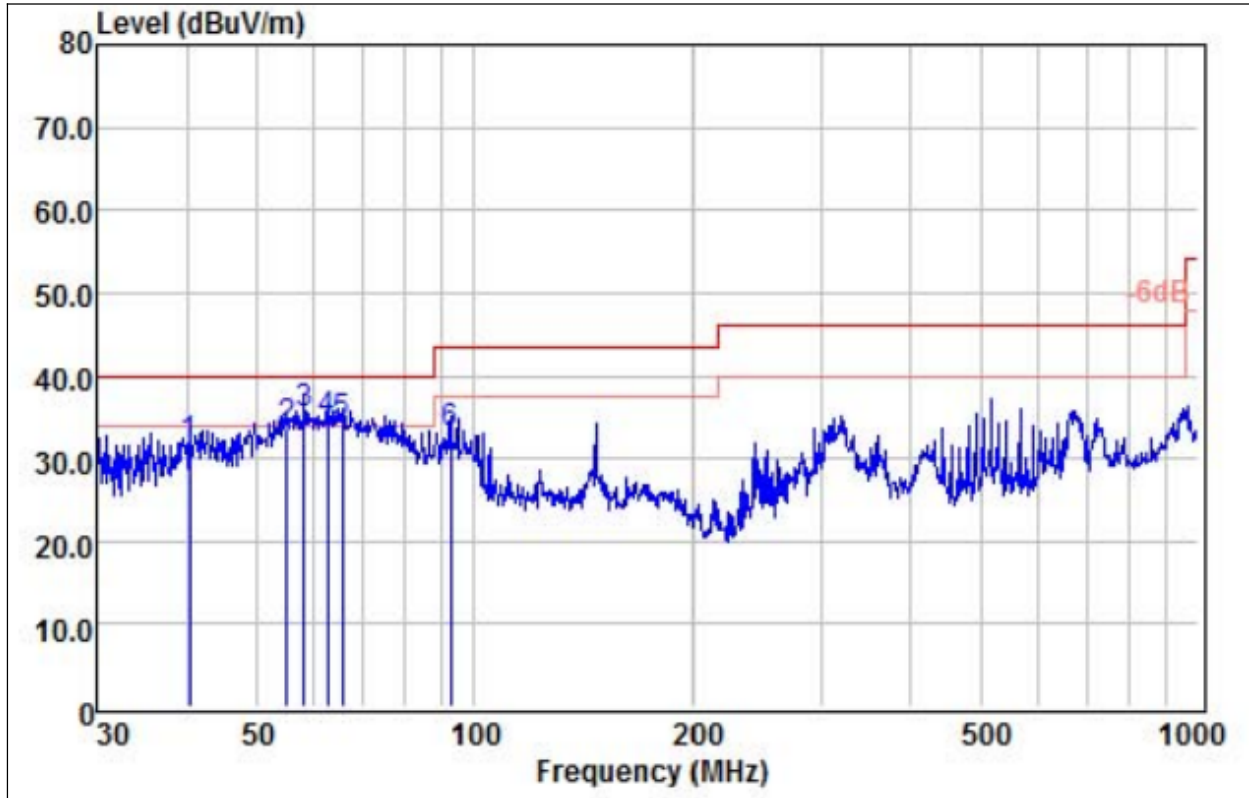

	ReadAntenna	Cable	Limit	Over			
Freq	Level	Factor	Loss	Level	Line	Limit	Remark
MHz	dBuV	dB/m	dB	dBuV/m	dBuV/m	dB	
1	40.28	18.43	12.79	0.28	31.50	40.00	-8.50 QP
2	55.03	25.01	8.05	0.41	33.47	40.00	-6.53 QP
3 !	58.00	27.33	7.60	0.49	35.42	40.00	-4.58 QP
4 !	62.65	26.64	7.35	0.62	34.61	40.00	-5.39 QP
5 !	65.57	25.98	7.41	0.70	34.09	40.00	-5.91 QP
6	92.79	23.01	9.24	0.84	33.09	43.50	-10.41 QP

Remarks:

- 1.Final Level =Receiver Read level + Antenna Factor + Cable Loss
- 2.The emission levels of other frequencies are very lower than the limit and not show in test report.

## 1GHz~25GHz

Polar (H/V)	Frequency	Meter Reading	Pre-amplifier	Cable Loss	Antenna Factor	Emission Level	Limits	Margin	Detector Type
	(MHz)	(dBuV)	(dB)	(dB)	(dB)	(dBuV/m)	(dBuV/m)	(dB)	
Low Channel:2403.5MHz									
V	4807	58.69	30.55	5.77	24.66	58.57	74	-15.43	Pk
V	4807	48.53	30.55	5.77	24.66	48.41	54	-5.59	AV
V	7211	57.34	30.33	6.32	24.55	57.88	74	-16.12	Pk
V	7211	47.09	30.33	6.32	24.55	47.63	54	-6.37	AV
V	9614	56.03	30.85	7.45	24.69	57.32	74	-16.68	Pk
V	9614	46.32	30.85	7.45	24.69	47.61	54	-6.39	AV
V	12018	54.29	31.02	8.99	25.57	57.83	74	-16.17	Pk
V	12018	44.81	31.02	8.99	25.57	48.35	54	-5.65	AV
H	4807	58.32	30.55	5.77	24.66	58.2	74	-15.8	Pk
H	4807	48.52	30.55	5.77	24.66	48.4	54	-5.6	AV
H	7211	57.86	30.33	6.32	24.55	58.4	74	-15.6	Pk
H	7211	47.84	30.33	6.32	24.55	48.38	54	-5.62	AV
H	9614	56.03	30.85	7.45	24.69	57.32	74	-16.68	Pk
H	9614	46.59	30.85	7.45	24.69	47.88	54	-6.12	AV
H	12018	54.11	31.02	8.99	25.57	57.65	74	-16.35	Pk
H	12018	44.83	31.02	8.99	25.57	48.37	54	-5.63	AV

Polar (H/V)	Frequency	Meter Reading	Pre-amplifier	Cable Loss	Antenna Factor	Emission Level	Limits	Margin	Detector Type
	(MHz)	(dBuV)	(dB)	(dB)	(dB)	(dBuV/m)	(dBuV/m)	(dB)	
Middle Channel:2440.4MHz									
V	4881	57.83	30.55	5.77	24.66	57.71	74	-16.29	Pk
V	4881	47.19	30.55	5.77	24.66	47.07	54	-6.93	AV
V	7321	56.22	30.33	6.32	24.55	56.76	74	-17.24	Pk
V	7321	46.57	30.33	6.32	24.55	47.11	54	-6.89	AV
V	9761	55.19	30.85	7.45	24.69	56.48	74	-17.52	Pk
V	9761	45.42	30.85	7.45	24.69	46.71	54	-7.29	AV
V	12202	54.38	31.02	8.99	25.57	57.92	74	-16.08	Pk
V	12202	44.16	31.02	8.99	25.57	47.7	54	-6.3	AV
H	4881	58.06	30.55	5.77	24.66	57.94	74	-16.06	Pk
H	4881	47.66	30.55	5.77	24.66	47.54	54	-6.46	AV
H	7321	57.49	30.33	6.32	24.55	58.03	74	-15.97	Pk
H	7321	46.92	30.33	6.32	24.55	47.46	54	-6.54	AV
H	9761	56.82	30.85	7.45	24.69	58.11	74	-15.89	Pk
H	9761	46.32	30.85	7.45	24.69	47.61	54	-6.39	AV
H	12202	54.12	31.02	8.99	25.57	57.66	74	-16.34	Pk
H	12202	44.91	31.02	8.99	25.57	48.45	54	-5.55	AV



Polar (H/V)	Frequency	Meter Reading	Pre-amplifier	Cable Loss	Antenna Factor	Emission Level	Limits	Margin	Detector Type
	(MHz)	(dBuV)	(dB)	(dB)	(dB)	(dBuV/m)	(dBuV/m)	(dB)	
High Channel:2477.3MHz									
V	4955	58.33	30.55	5.77	24.66	58.21	74	-15.79	Pk
V	4955	48.75	30.55	5.77	24.66	48.63	54	-5.37	AV
V	7432	57.46	30.33	6.32	24.55	58	74	-16	Pk
V	7432	47.22	30.33	6.32	24.55	47.76	54	-6.24	AV
V	9909	56.49	30.85	7.45	24.69	57.78	74	-16.22	Pk
V	9909	46.51	30.85	7.45	24.69	47.8	54	-6.2	AV
V	12387	55.02	31.02	8.99	25.57	58.56	74	-15.44	Pk
V	12387	45.16	31.02	8.99	25.57	48.7	54	-5.3	AV
H	4955	58.69	30.55	5.77	24.66	58.57	74	-15.43	Pk
H	4955	48.74	30.55	5.77	24.66	48.62	54	-5.38	AV
H	7432	57.84	30.33	6.32	24.55	58.38	74	-15.62	Pk
H	7432	47.66	30.33	6.32	24.55	48.2	54	-5.8	AV
H	9909	56.39	30.85	7.45	24.69	57.68	74	-16.32	Pk
H	9909	46.08	30.85	7.45	24.69	47.37	54	-6.63	AV
H	12387	55.04	31.02	8.99	25.57	58.58	74	-15.42	Pk
H	12387	45.39	31.02	8.99	25.57	48.93	54	-5.07	AV

Remark:

1. Emission Level = Meter Reading + Antenna Factor + Cable Loss – Pre-amplifier,  
Margin= Emission Level - Limit
2. If peak below the average limit, the average emission was no test.
3. The amplitude of spurious emissions which are attenuated by more than 20dB below the permissible value has no need to be reported.

## 5. RADIATED BAND EMISSION MEASUREMENT

### 5.1 TEST REQUIREMENT:

Test Requirement:	FCC Part15 C Section 15.209 and 15.205 RSS-Gen 8.9, RSS-Gen 8.10				
Test Method:	ANSI C63.10: 2013 and RSS-Gen				
Test Frequency Range:	All of the restrict bands were tested, only the worst band's (2310MHz to 2500MHz) data was showed.				
Test site:	Measurement Distance: 3m				
Receiver setup:	Frequency	Detector	RBW	VBW	Value
	Above 1GHz	Peak	1MHz	3MHz	Peak
		Average	1MHz	1/T	Average

### LIMITS OF RADIATED EMISSION MEASUREMENT (Above 1000MHz)

FREQUENCY (MHz)	Limit (dBuV/m) (at 3M)	
	PEAK	AVERAGE
Above 1000	74	54

#### Notes:

- (1) The limit for radiated test was performed according to FCC PART 15C.
- (2) The tighter limit applies at the band edges.
- (3) Emission level (dBuV/m)=20log Emission level (uV/m).

### 5.2 TEST PROCEDURE

Above 1GHz test procedure as below:

- a. 1. The EUT was placed on the top of a rotating table 1.5 meters above the ground at a 3 meter camber. The table was rotated 360 degrees to determine the position of the highest radiation.
- b. The EUT was set 3 meters away from the interference-receiving antenna, which was mounted on the top of a variable-height antenna tower.
- c. The antenna height is varied from one meter to four meters above the ground to determine the maximum value of the field strength. Both horizontal and vertical polarizations of the antenna are set to make the measurement.
- d. For each suspected emission, the EUT was arranged to its worst case and then the antenna was tuned to heights from 1 meter to 4 meters and the rota table was turned from 0 degrees to 360 degrees to find the maximum reading.
- e. The test-receiver system was set to Peak Detect Function and Specified Bandwidth with Maximum Hold Mode.
- f. If the emission level of the EUT in peak mode was 10dB lower than the limit specified, then testing could be stopped and the peak values of the EUT would be reported. Otherwise the emissions that did not have 10dB margin would be re-tested one by one using peak, quasi-peak or average method as specified and then reported in a data sheet.
- g. Test the EUT in the lowest channel, the Highest channel

#### Note:

Both horizontal and vertical antenna polarities were tested and performed pretest to three orthogonal axis. The worst case emissions were reported

### 5.3 DEVIATION FROM TEST STANDARD

No deviation

## 5.4 TEST SETUP

### Radiated Emission Test-Up Frequency Above 1GHz

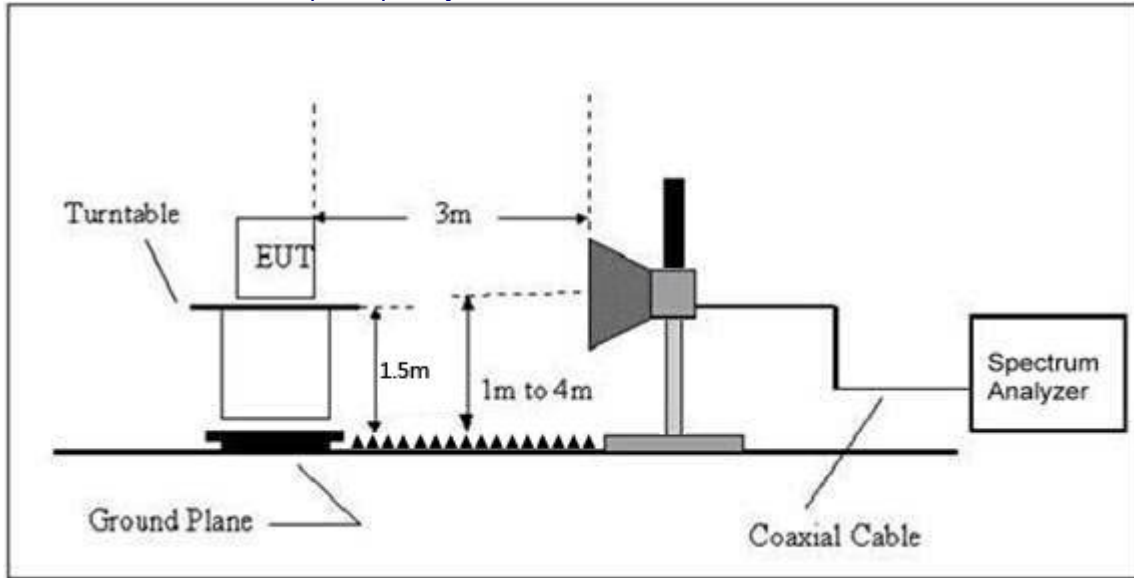

### 5.5 EUT OPERATING CONDITIONS

The EUT tested system was configured as the statements of 2.3 Unless otherwise a special operating condition is specified in the follows during the testing.

**5.6 TEST RESULT**

	Polar (H/V)	Frequency (MHz)	Meter Reading (dBuV)	Pre-amplifier (dB)	Cable Loss (dB)	Antenna Factor (dB/m)	Emission level (dBuV/m)	Limit (dBuV/m)	Detector Type	Result	
FSK	Low Channel: 2403.5MHz										
	H	2310	57.82	30.21	4.83	23.97	56.41	74	PK	PASS	
	H	2310	47.74	30.21	4.83	23.97	46.33	54	AV	PASS	
	H	2390	56.83	30.22	4.85	23.98	55.44	74	PK	PASS	
	H	2390	46.39	30.22	4.85	23.98	45	54	AV	PASS	
	H	2400	56.81	30.23	4.86	23.99	55.43	74	PK	PASS	
	H	2400	46.75	30.23	4.86	23.99	45.37	54	AV	PASS	
	V	2310	56.63	30.21	4.83	23.97	55.22	74	PK	PASS	
	V	2310	46.59	30.21	4.83	23.97	45.18	54	AV	PASS	
	V	2390	57.22	30.22	4.85	23.98	55.83	74	PK	PASS	
	V	2390	47.19	30.22	4.85	23.98	45.8	54	AV	PASS	
	V	2400	56.83	30.23	4.86	23.99	55.45	74	PK	PASS	
	V	2400	46.51	30.23	4.86	23.99	45.13	54	AV	PASS	
	High Channel: 2477.3MHz										
	H	2483.5	57.43	30.36	4.92	24.11	56.1	74	PK	PASS	
	H	2483.5	47.52	30.36	4.92	24.11	46.19	54	AV	PASS	
	H	2500	56.08	30.38	4.94	24.14	54.78	74	PK	PASS	
	H	2500	46.34	30.38	4.94	24.14	45.04	54	AV	PASS	
	V	2483.5	57.41	30.36	4.92	24.11	56.08	74	PK	PASS	
	V	2483.5	47.23	30.36	4.92	24.11	45.9	54	AV	PASS	
V	2500	56.93	30.38	4.94	24.14	55.63	74	PK	PASS		
V	2500	46.88	30.38	4.94	24.14	45.58	54	AV	PASS		
<b>Remark:</b>											
1. Emission Level = Meter Reading + Antenna Factor + Cable Loss – Pre-amplifier, Margin= Emission Level - Limit											

## 6. POWER SPECTRAL DENSITY TEST

Test Requirement:	FCC Part15 C Section 15.247 (e)&RSS-247 [5.2(2)]
Test Method:	KDB558074 D0115.247 Meas Guidance v05r02 and RSS-Gen

### 6.1 APPLIED PROCEDURES / LIMIT

FCC Part15 (15.247) , Subpart C				
Section	Test Item	Limit	Frequency Range (MHz)	Result
15.247	Power Spectral Density	8dBm/3kHz	2400-2483.5	PASS

### 6.2 TEST PROCEDURE

1. Set analyzer center frequency to DTS channel center frequency.
2. Set the span to 1.5 times the DTS bandwidth.
3. Set the RBW to:  $3 \text{ kHz} \leq \text{RBW} \leq 100 \text{ kHz}$ .
4. Set the VBW  $\geq 3 \times \text{RBW}$ .
5. Detector = peak.
6. Sweep time = auto couple.
7. Trace mode = max hold.
8. Allow trace to fully stabilize.
9. Use the peak marker function to determine the maximum amplitude level within the RBW.
10. If measured value exceeds limit, reduce RBW (no less than 3 kHz) and repeat.

### 6.3 DEVIATION FROM STANDARD

No deviation.

### 6.4 TEST SETUP



### 6.5 EUT OPERATION CONDITIONS

The EUT tested system was configured as the statements of 2.1 Unless otherwise a special operating condition is specified in the follows during the testing.

6.6 TEST RESULTS

Temperature :	26°C	Relative Humidity :	54%
Test Mode :	FSK	Test Voltage :	AC 120V/60Hz

Frequency	Power Spectral Density(dBm/3kHz)	Limit (dBm/3kHz)	Result
2403.5 MHz	-12.927	8	PASS
2440.4 MHz	-12.362	8	PASS
2477.3 MHz	-11.853	8	PASS

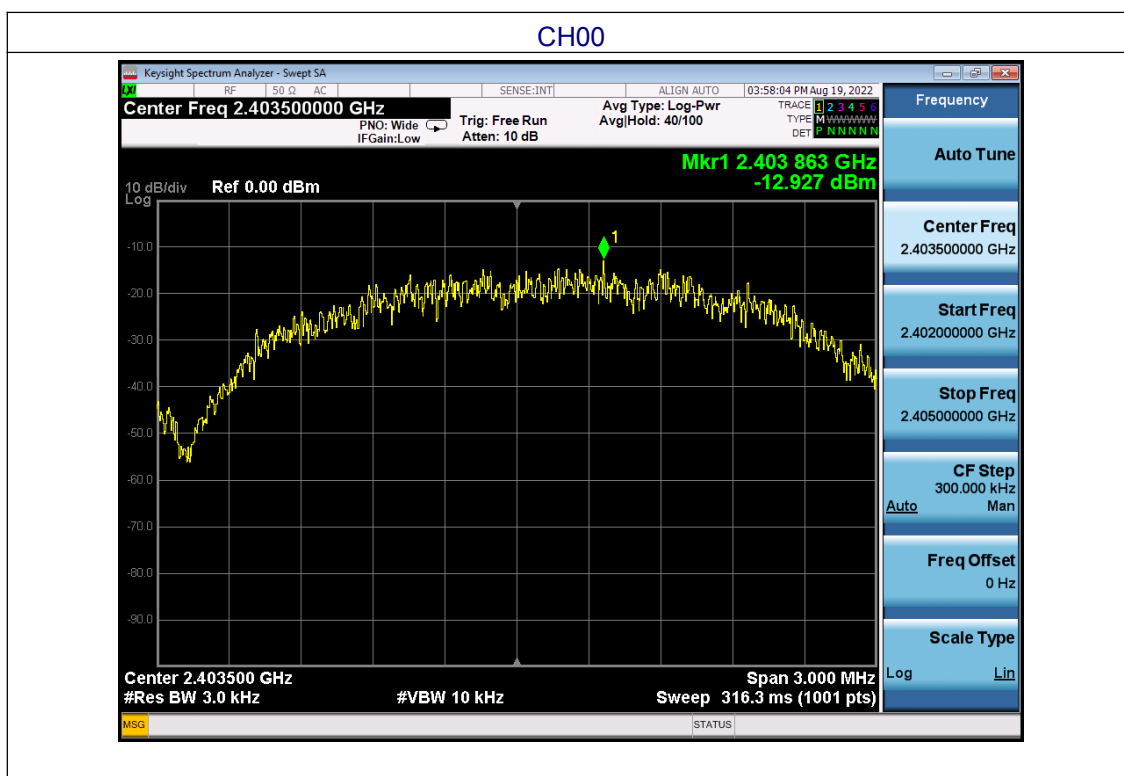

CH24

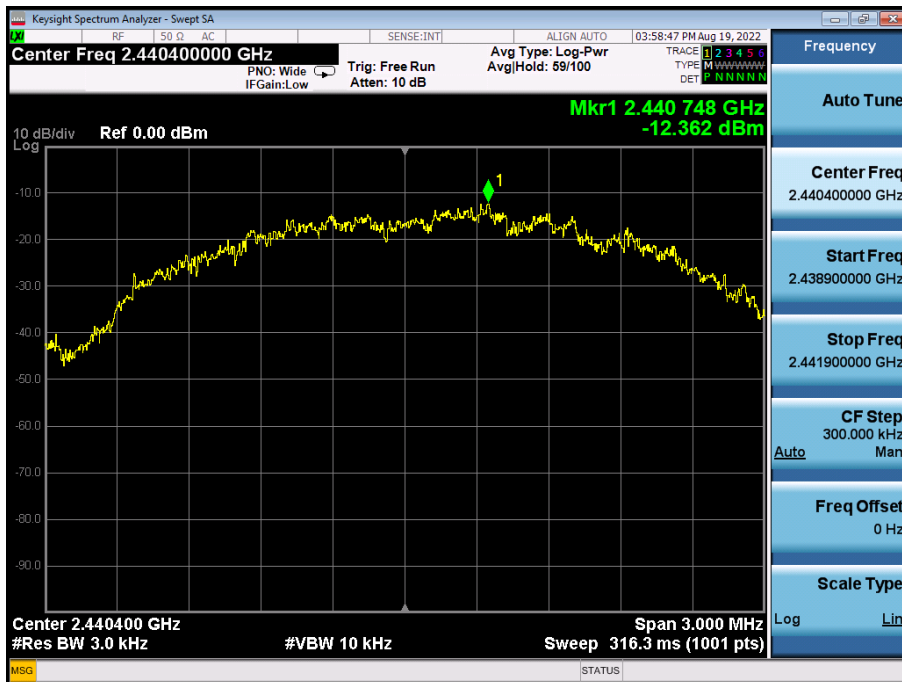

CH48

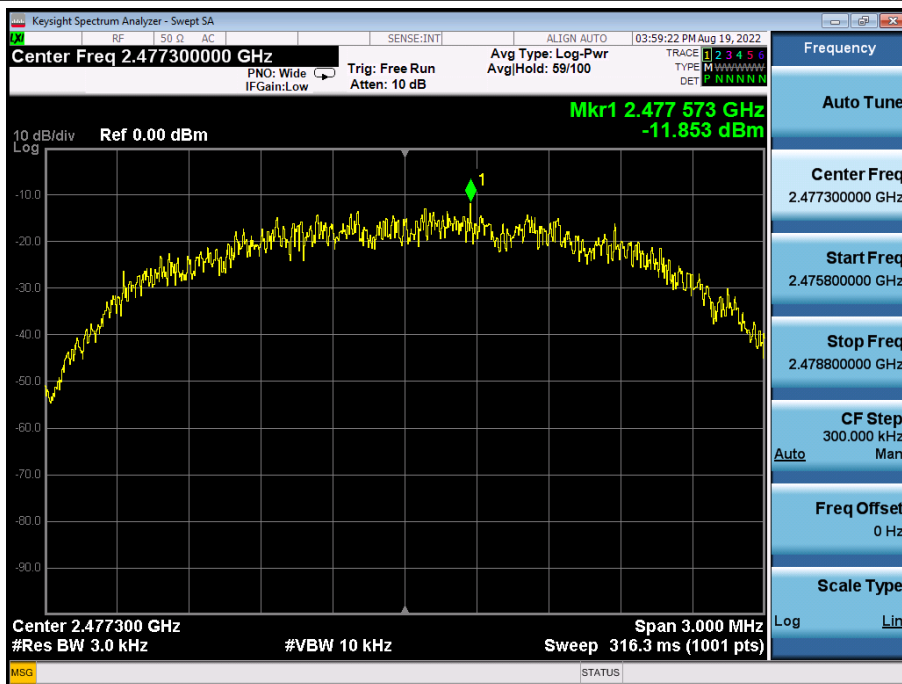

## 7. CHANNEL BANDWIDTH

Test Requirement:	FCC Part15 C Section 15.247 (a)(2)&RSS-247[5.2(1)]
Test Method:	KDB558074 D0115.247 Meas Guidance v05r02 and RSS-Gen

### 7.1 APPLIED PROCEDURES / LIMIT

FCC Part15 (15.247) , Subpart C				
Section	Test Item	Limit	Frequency Range (MHz)	Result
15.247(a)(2)	Bandwidth	$\geq 500\text{KHz}$ (6dB bandwidth)	2400-2483.5	PASS

### 7.2 TEST PROCEDURE

1. Set RBW = 100 kHz.
2. Set the video bandwidth (VBW)  $\geq 3 \times$  RBW.
3. Detector = Peak.
4. Trace mode = max hold.
5. Sweep = auto couple.
6. Allow the trace to stabilize.
7. Measure the maximum width of the emission that is constrained by the frequencies associated with the two outermost amplitude points (upper and lower frequencies) that are attenuated by 6 dB relative to the maximum level measured in the fundamental emission.

### 7.3 DEVIATION FROM STANDARD

No deviation.

### 7.4 TEST SETUP



### 7.5 EUT OPERATION CONDITIONS

The EUT tested system was configured as the statements of 2.4 Unless otherwise a special operating condition is specified in the follows during the testing.



### 7.6 TEST RESULTS

Temperature :	26°C	Relative Humidity :	54%
Test Mode :	FSK	Test Voltage :	AC 120V/60Hz

Test channel	6dB Bandwidth (MHz)	99% Bandwidth (MHz)	Limit(KHz)	Result
Lowest	1.654	2.152	>500	Pass
Middle	1.641	2.169		
Highest	1.615	2.125		

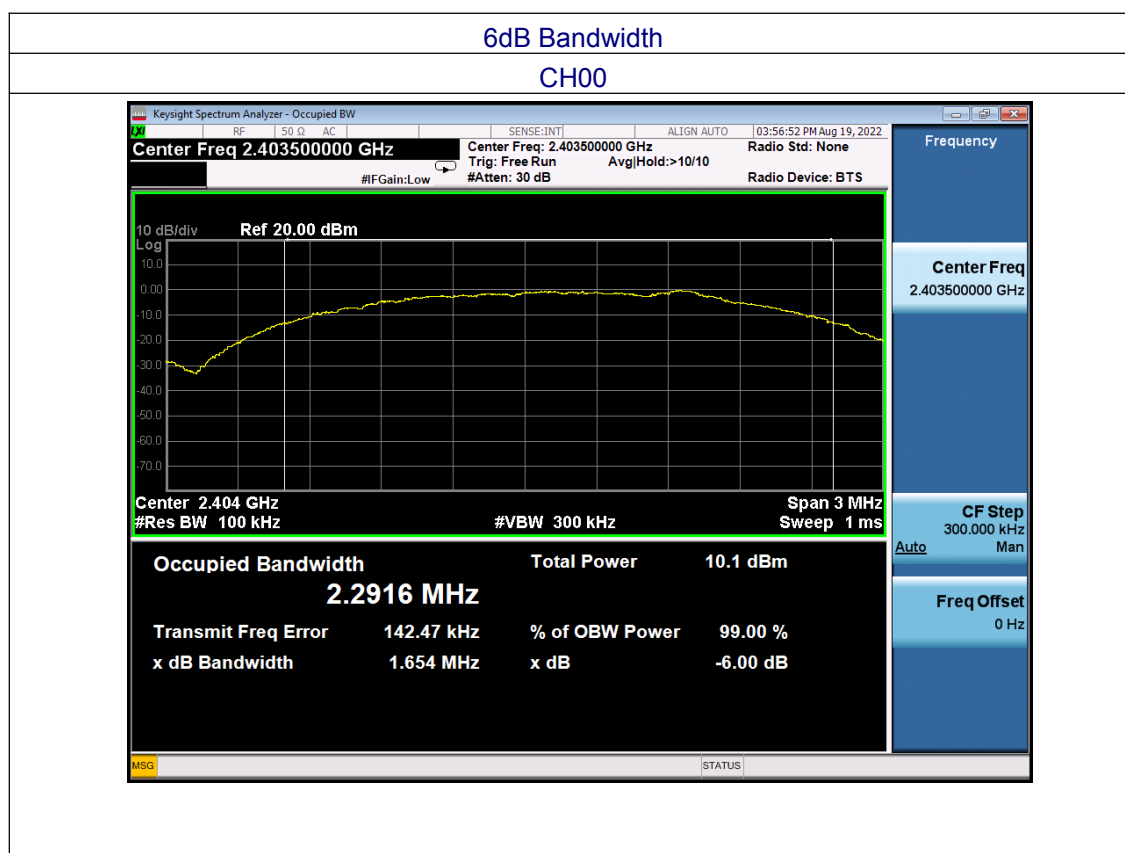

CH24



CH48

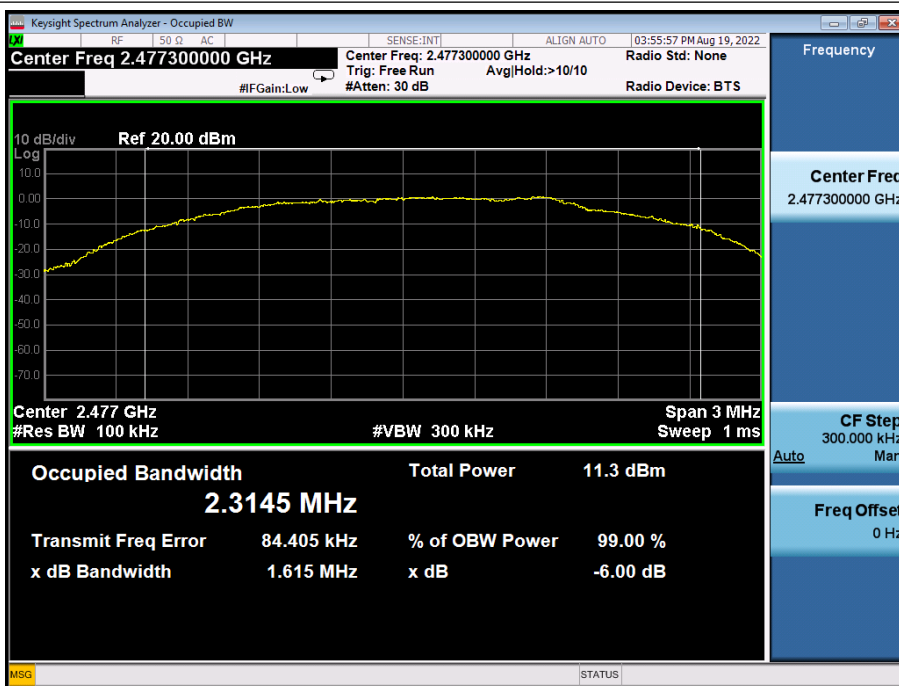

99% Bandwidth

CH00

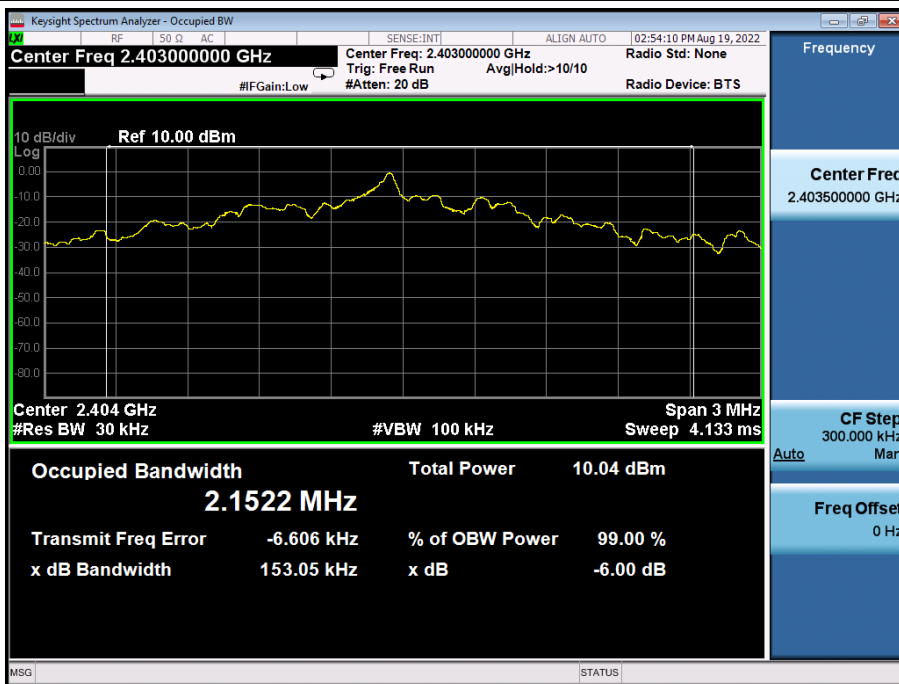

CH24

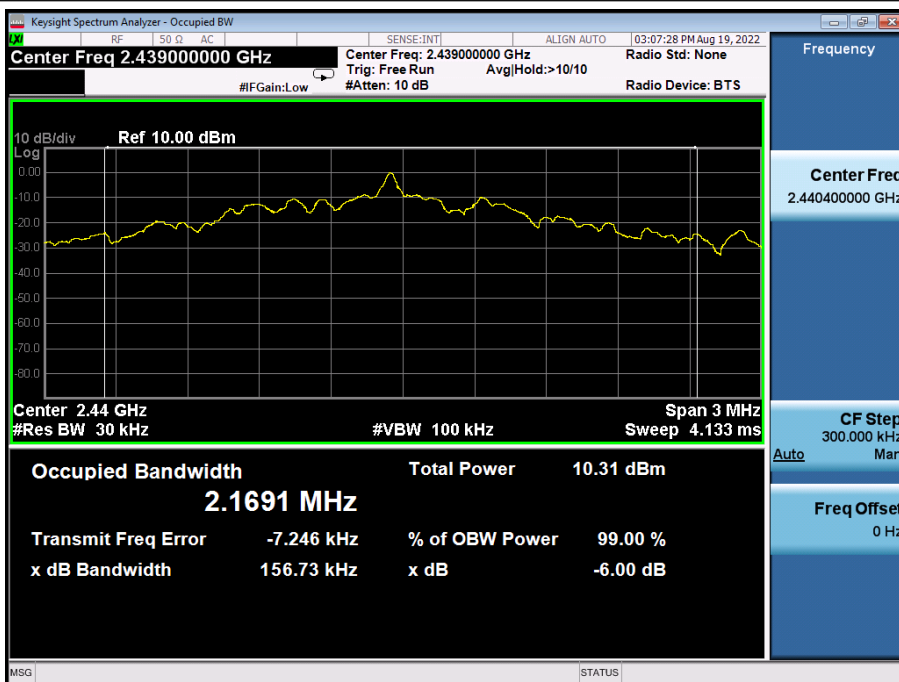

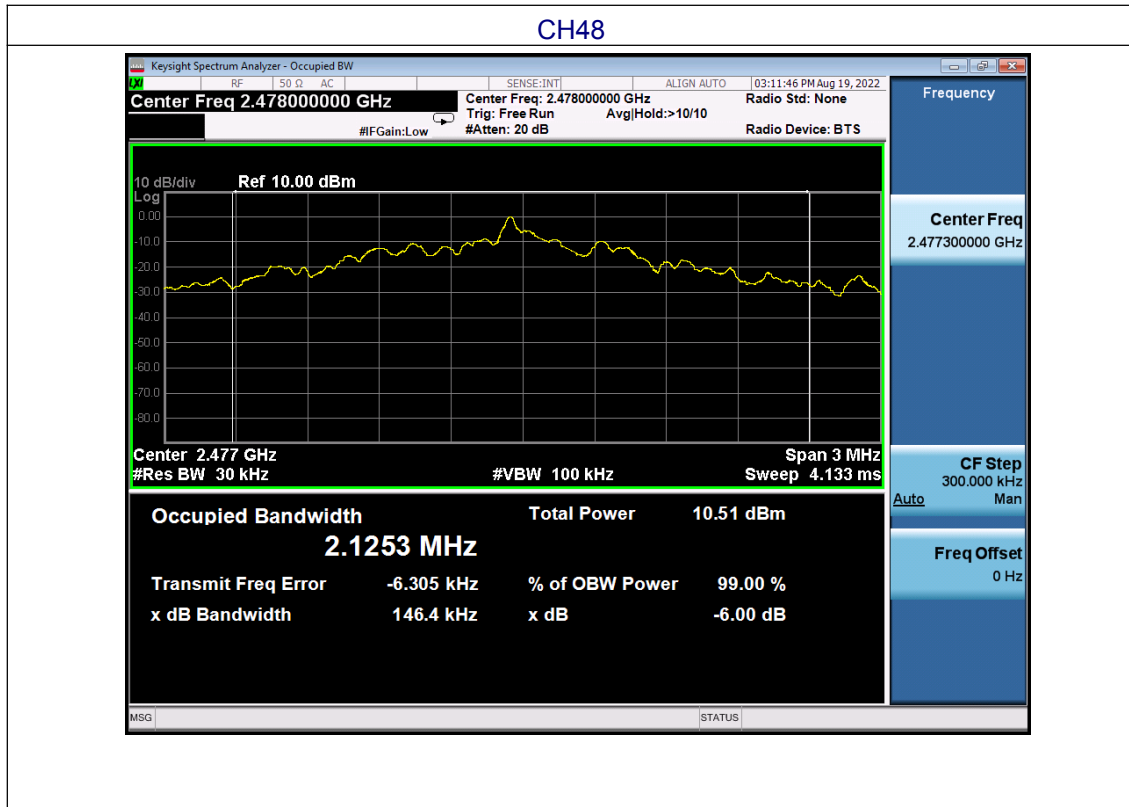

## 8. PEAK OUTPUT POWER TEST

Test Requirement:	FCC Part15 C Section 15.247 (b)(3)&RSS-247 5.4(4)
Test Method:	KDB558074 D0115.247 Meas Guidance v05r02 and RSS-Gen

### 8.1 APPLIED PROCEDURES / LIMIT

FCC Part15 (15.247) , Subpart C				
Section	Test Item	Limit	Frequency Range (MHz)	Result
15.247(b)(3)	Peak Output Power	1 watt or 30dBm	2400-2483.5	PASS

### 8.2 TEST PROCEDURE

- a. The EUT was directly connected to the Spectrum analyzer

### 8.3 DEVIATION FROM STANDARD

No deviation.

### 8.4 TEST SETUP

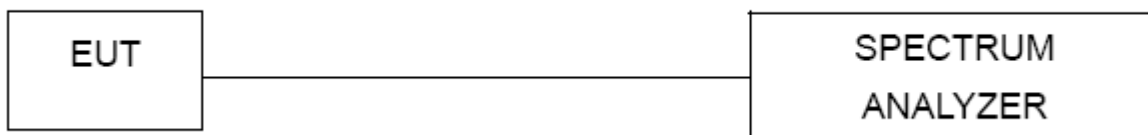

### 8.5 EUT OPERATION CONDITIONS

The EUT tested system was configured as the statements of 2.4 Unless otherwise a special operating condition is specified in the follows during the testing.

8.6 TEST RESULTS

Temperature :	26°C	Relative Humidity :	54%
Test Mode :	FSK	Test Voltage :	AC 120V/60Hz

Test channel	Peak Output Power (dBm)	Limit(dBm)	Result
Lowest	3.874	30.00	Pass
Middle	3.803		
Highest	4.768		

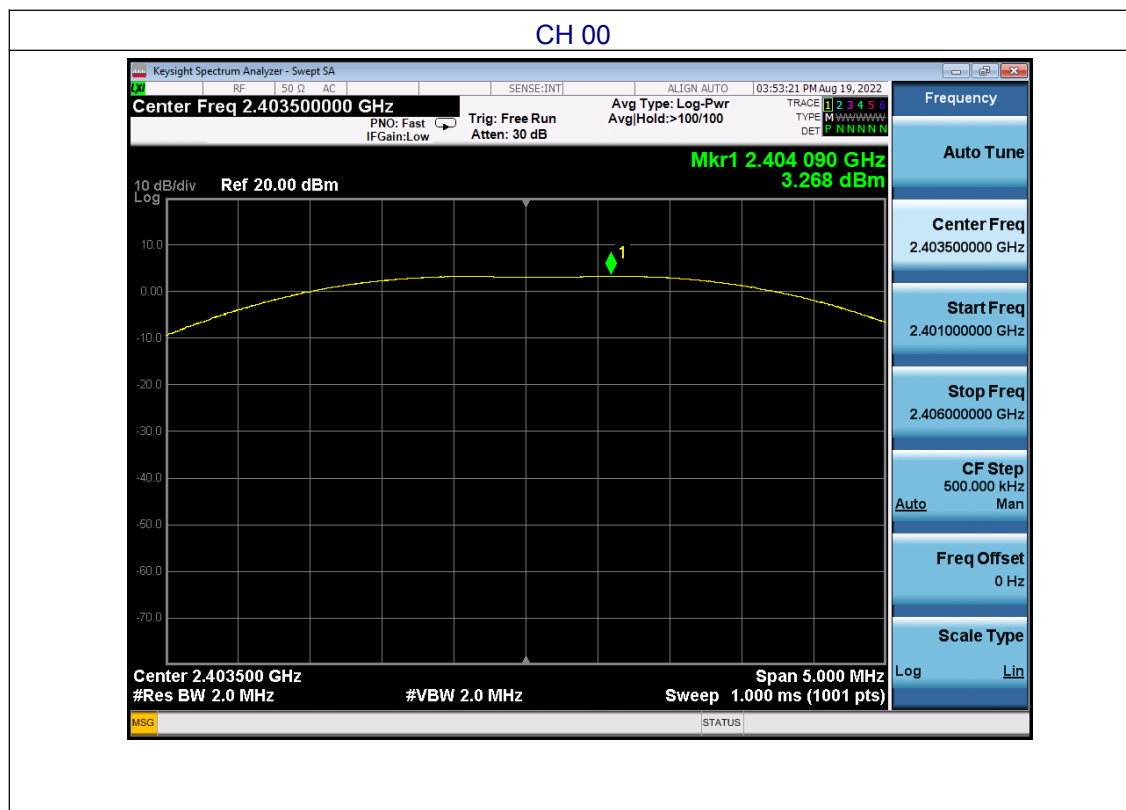

CH24

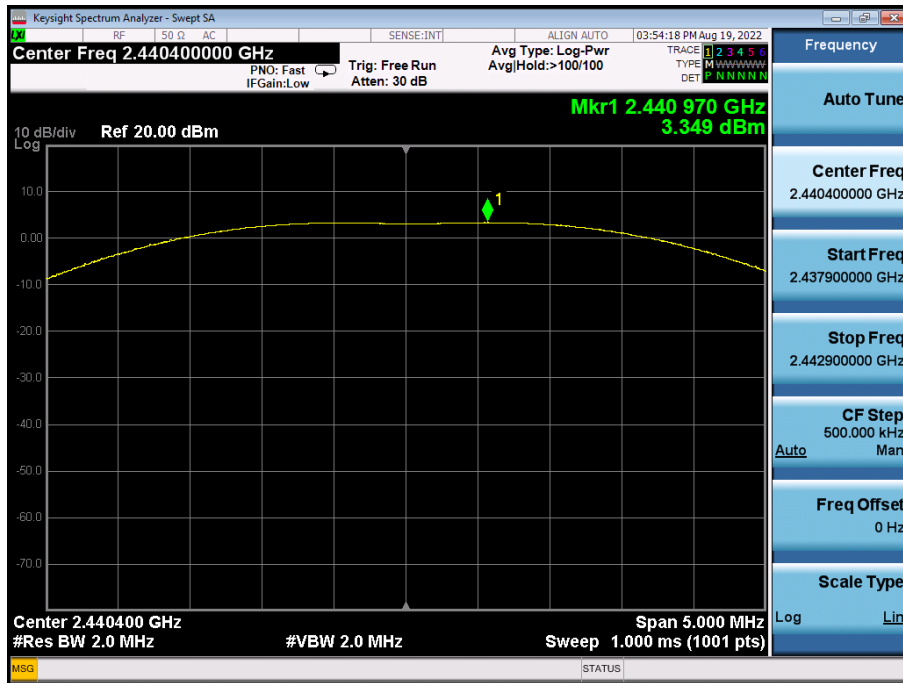

CH48

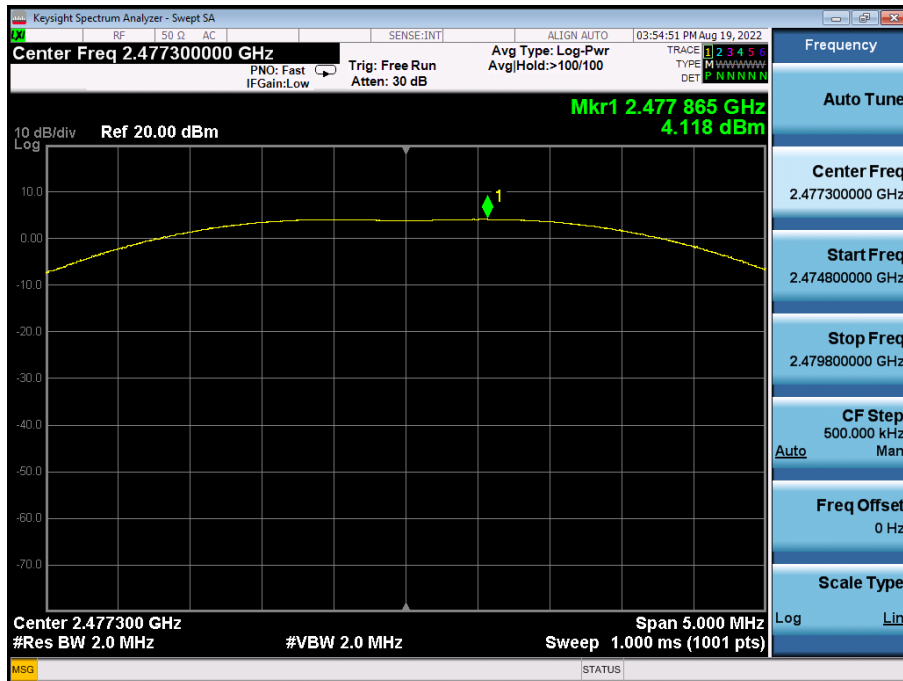

## 9. CONDUCTED BAND EDGE AND SPURIOUS EMISSION

Test Requirement:	FCC Part15 C Section 15.247 (d)&RSS-247 5.5
Test Method:	KDB558074 D0115.247 Meas Guidance v05r02 and RSS-Gen

### 9.1 APPLICABLE STANDARD

In any 100 kHz bandwidth outside the frequency band in which the spread spectrum intentional radiator is operating, the radio frequency power that is produced by the intentional radiator shall be at least 20 dB below that in the 100 kHz bandwidth within the band that contains the highest level of the desired power, based on either an RF conducted or a radiated measurement.

### 9.2 TEST PROCEDURE

Using the following spectrum analyzer setting:

- A) Set the RBW = 100KHz.
- B) Set the VBW = 300KHz.
- C) Sweep time = auto couple.
- D) Detector function = peak.
- E) Trace mode = max hold.
- F) Allow trace to fully stabilize.

### 9.3 DEVIATION FROM STANDARD

No deviation.

### 9.4 TEST SETUP



### 9.5 EUT OPERATION CONDITIONS

The EUT tested system was configured as the statements of 2.4 Unless otherwise a special operating condition is specified in the follows during the testing.

### 9.6 TEST RESULTS

Frequency Band	Delta Peak to band emission(dBc)	>Limit (dBc)	Result
Left-band	44.311	20	Pass
Right-band	46.388	20	Pass



FSK: Band Edge, Left Side

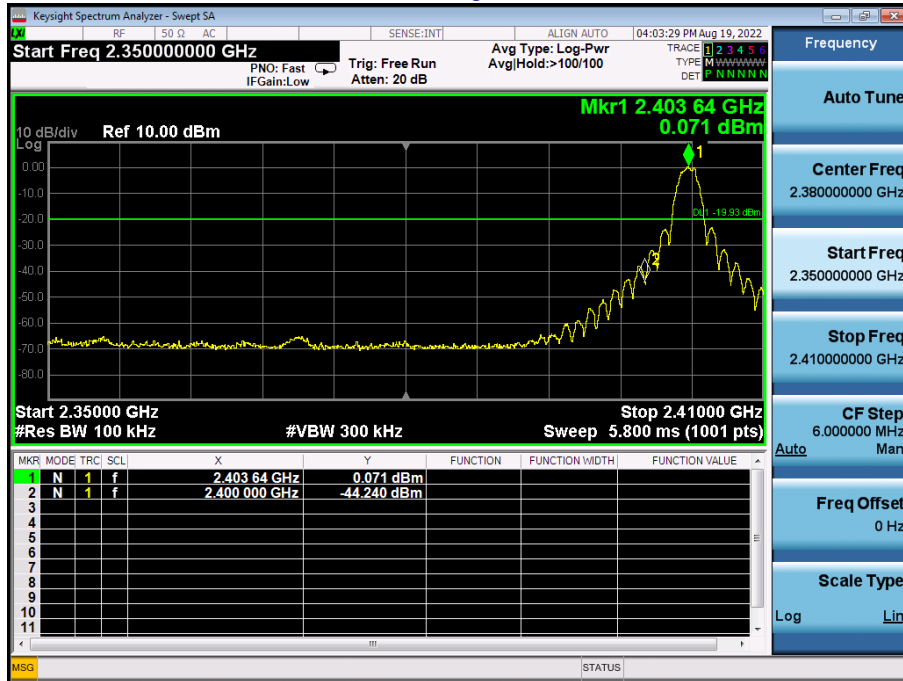

FSK: Band Edge, Right Side

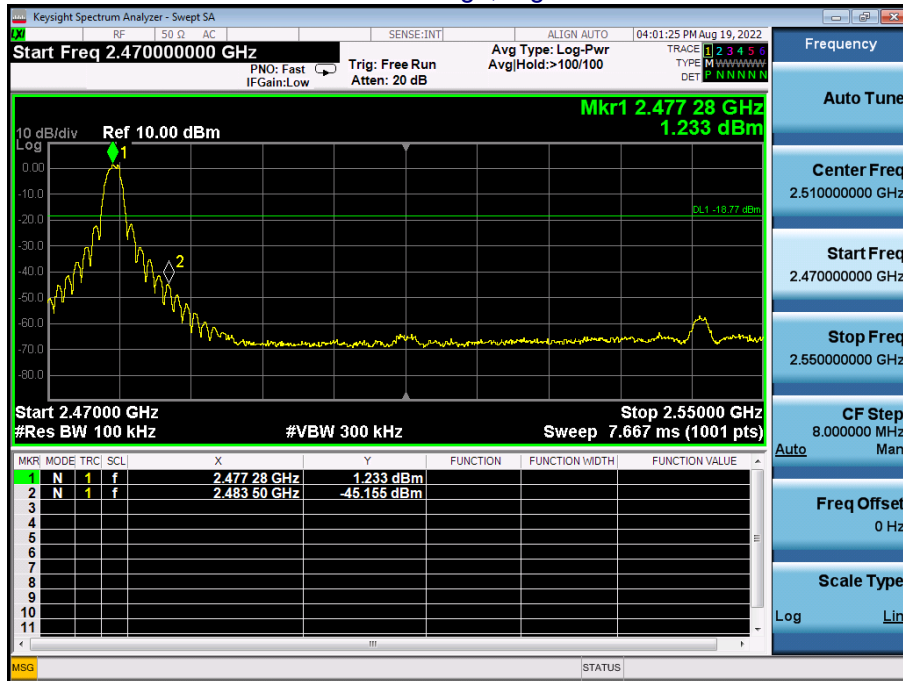

SPURIOUS RF CONDUCTED EMISSION TEST RESULT

CH: 2403.5MHz

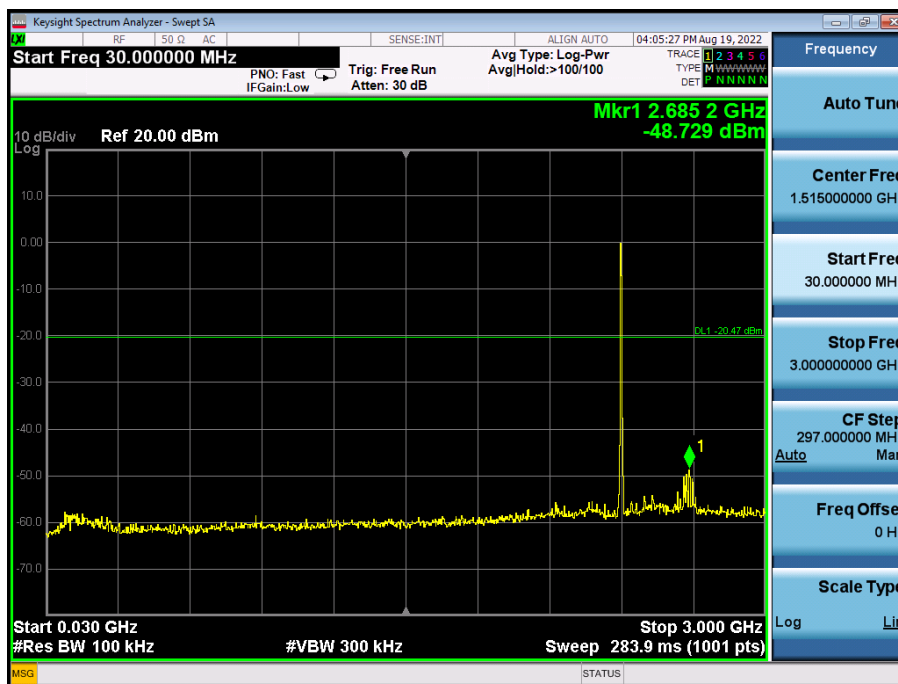

30MHz~3GHz



3GHz~25GHz

CH: 2440.4MHz

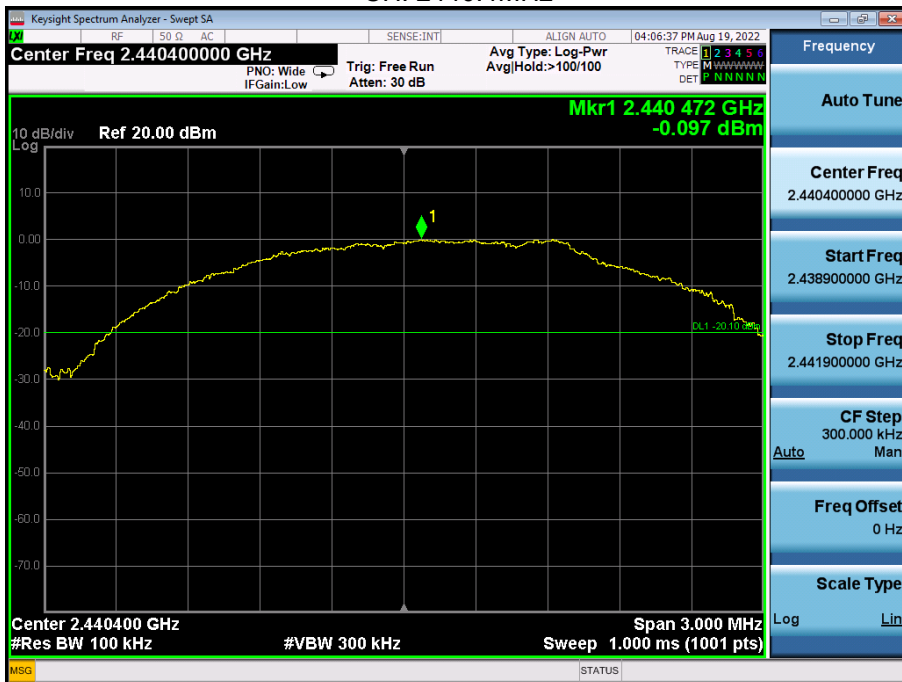

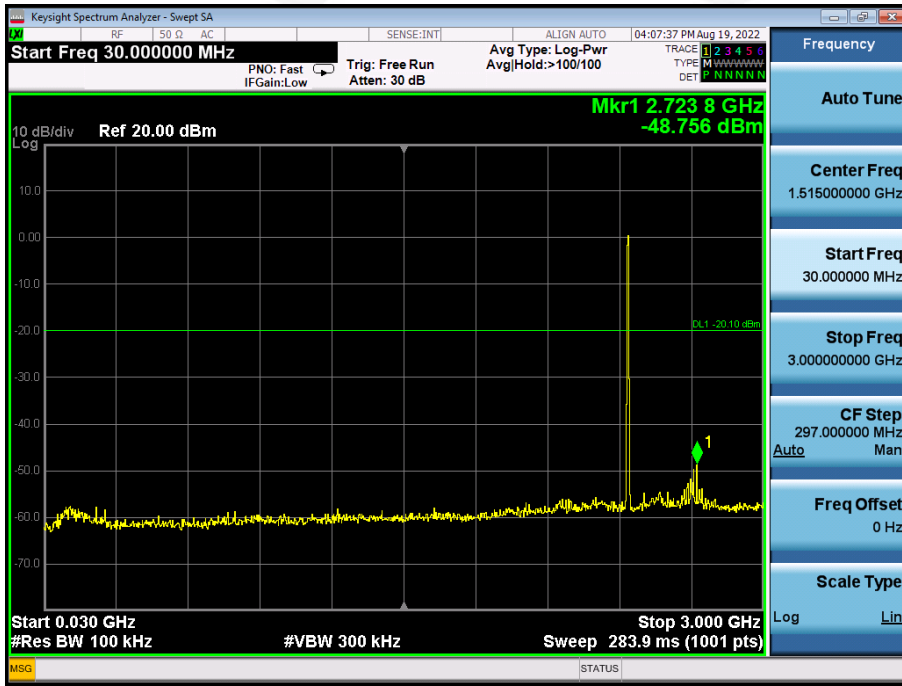

30MHz~3GHz

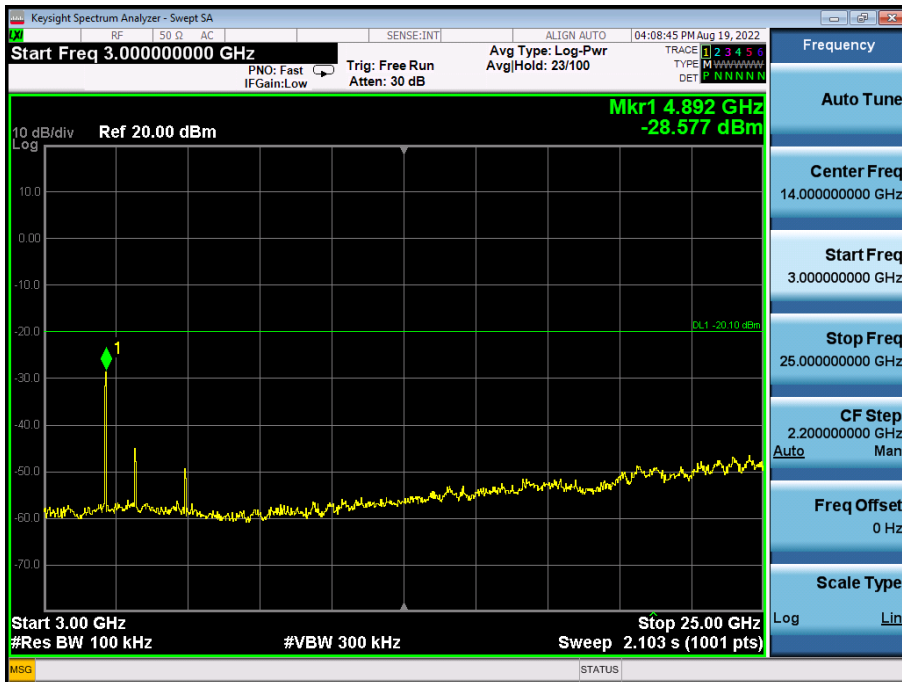

3GHz~25GHz

CH: 2477.3MHz

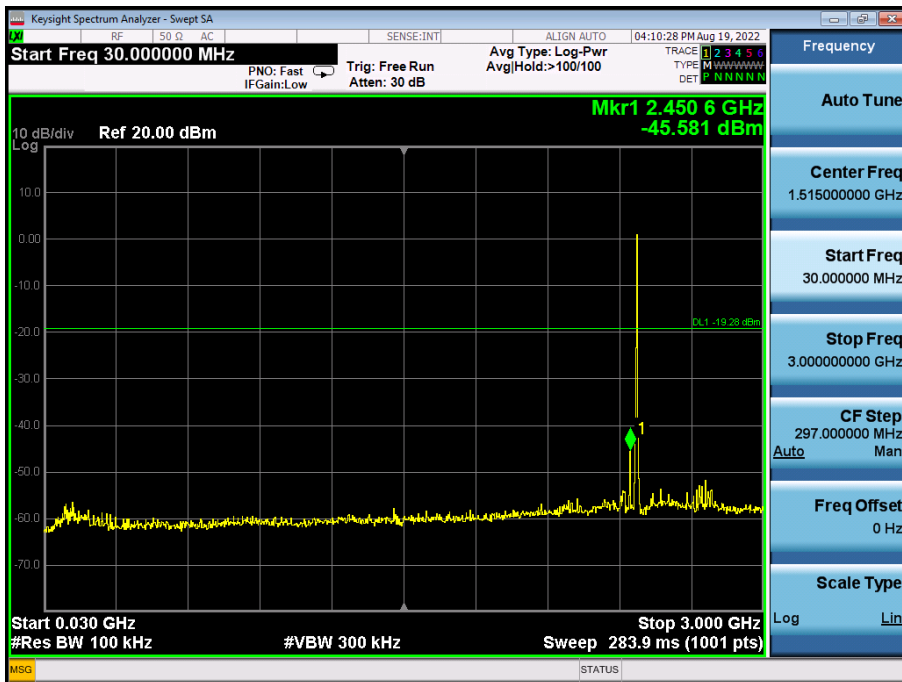

30MHz~3GHz

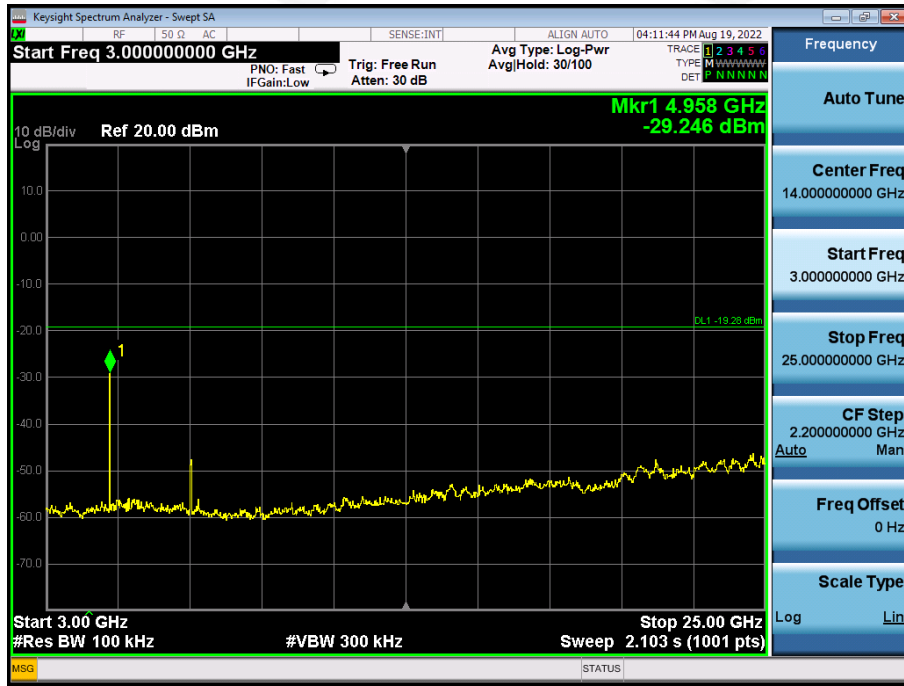

3GHz~25GHz

**10.ANTENNA REQUIREMENT**

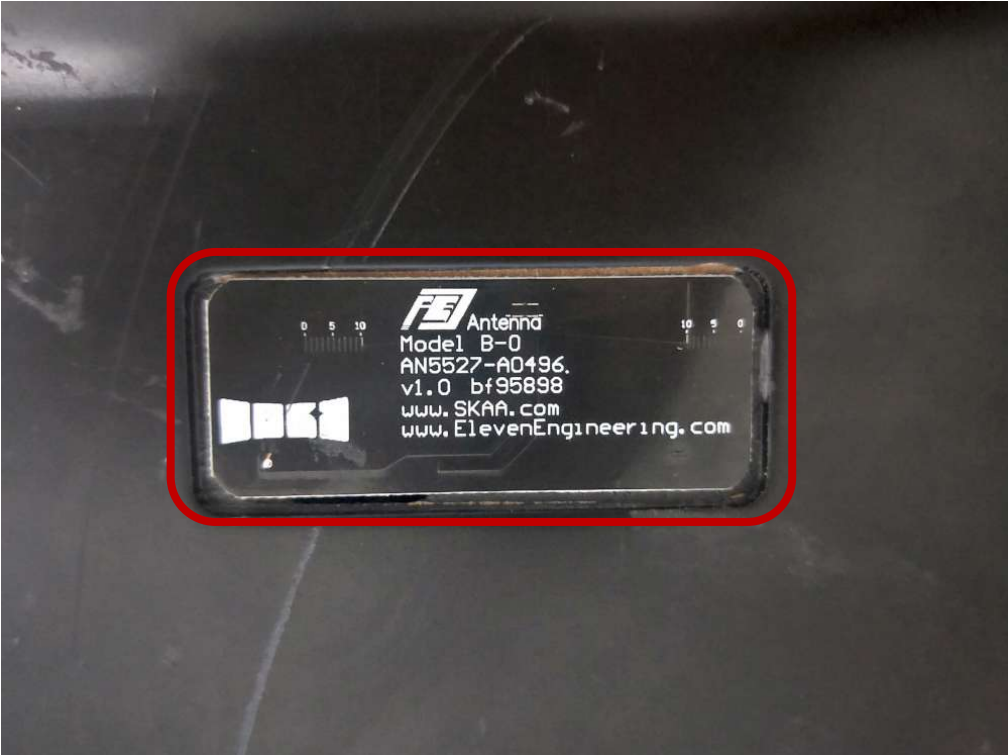
Standard requirement:	FCC Part15 C Section 15.203 /247(c)&RSS-Gen 6.8
<p>15.203 requirement: An intentional radiator shall be designed to ensure that no antenna other than that furnished by the responsible party shall be used with the device. The use of a permanently attached antenna or of an antenna that uses a unique coupling to the intentional radiator, the manufacturer may design the unit so that a broken antenna can be replaced by the user, but the use of a standard antenna jack or electrical connector is prohibited.</p> <p>15.247(c) (1)(i) requirement: (i) Systems operating in the 2400-2483.5 MHz band that is used exclusively for fixed. Point-to-point operations may employ transmitting antennas with directional gain greater than 6dBi provided the maximum conducted output power of the intentional radiator is reduced by 1 dB for every 3 dB that the directional gain of the antenna exceeds 0dBi.</p>	
EUT Antenna:	
The antennas are Bowtie Dipole, the best case gain of the antennas are 2.3dBi.	
	

## 11. TEST SETUP PHOTO

Reference to the appendix I for details.

## 12. EUT CONSTRUCTIONAL DETAILS

Reference to the appendix II for details.

\*\*\*\*\* END OF REPORT \*\*\*\*\*