



深圳市朋伴兴业科技有限公司



集研发，制造，销售为一体
专注天线领域的研发与应用

www.szpbxy.com

深圳市龙华区民治街道民治社区1970科技园4栋608室

Shenzhen Pengban Xinye Technology Co., Ltd

Room 605, Building 4, 1970 Science and Technology Town, Minzhi Street,
Longhua District, Shenzhen, China

Customer: 蓝雅通

Model Name: F5

Date: 2023/08/17

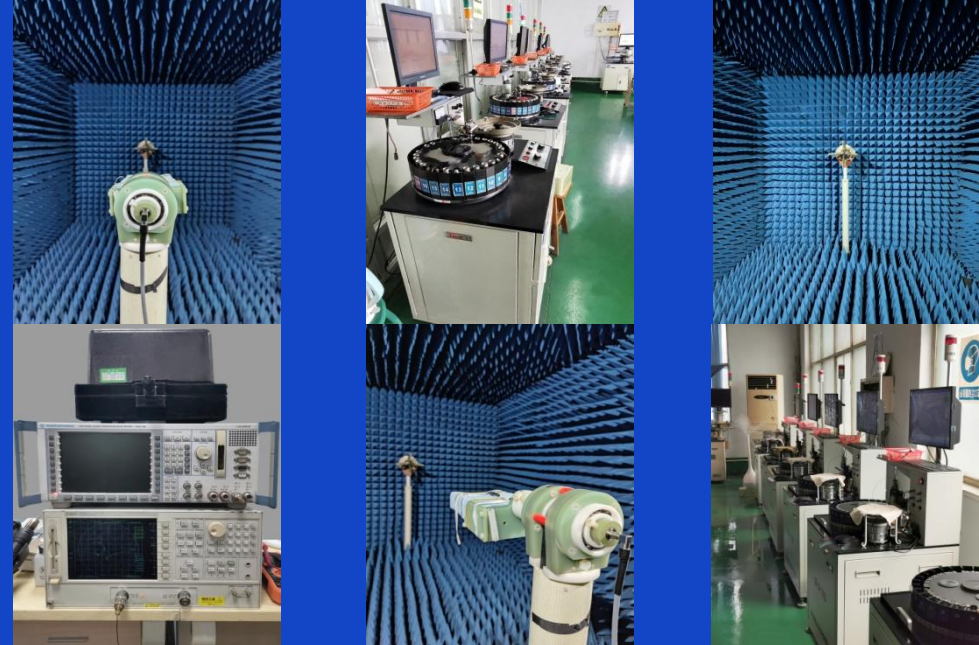

Antenna test report
天线调试报告

CONTENTS

目录

- 01 F5-Product appearance**
- 02 F5-Matching circuit (L/R)**
- 03 F5-Smith chart**
- 04 F5-Testing**
- 05 F5-OTA测试-L/R**
- 06 F5-OTA测试方向图-L/R**
- 07 F5-L/R效率与增益**

01 F5-Product appearance



02 F5-Matching circuit (L/R)

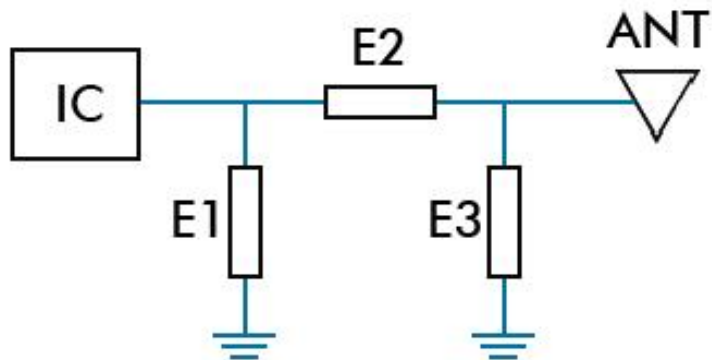

天线位置

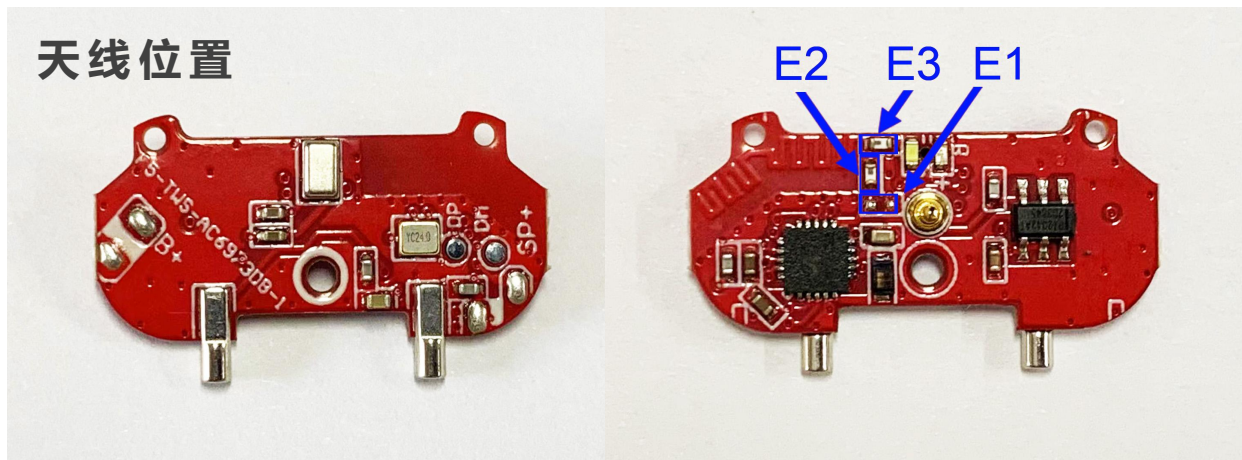

F5-匹配电路 (朋伴)

ANT	Antenna module on the system board
E1	NC
E2	7.5NH
E3	9.1NH

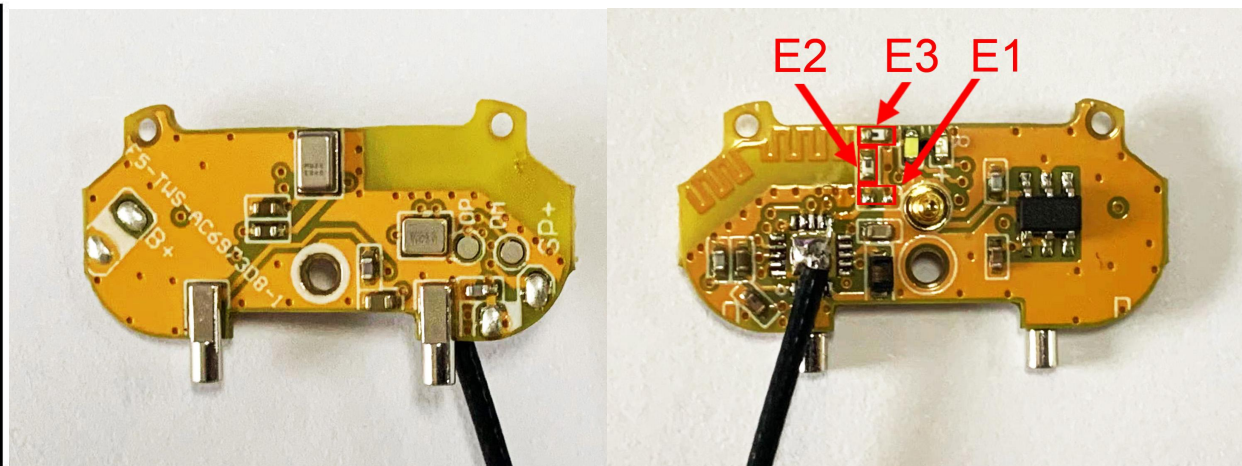

03 F5-Smith chart

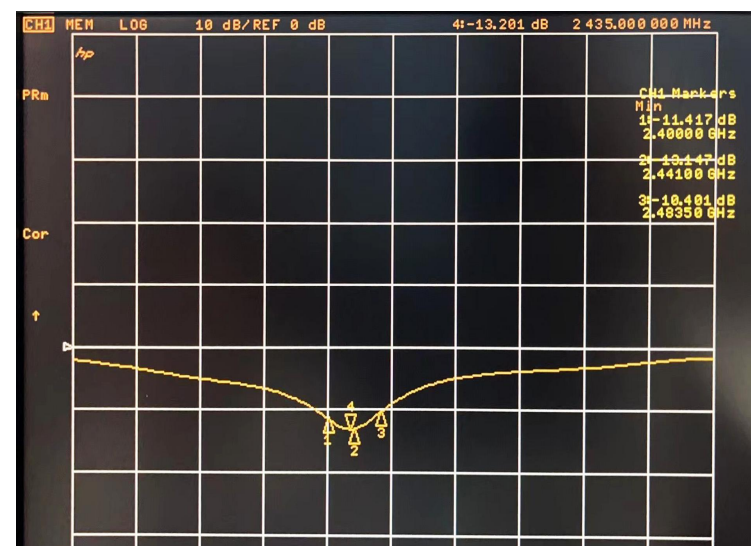
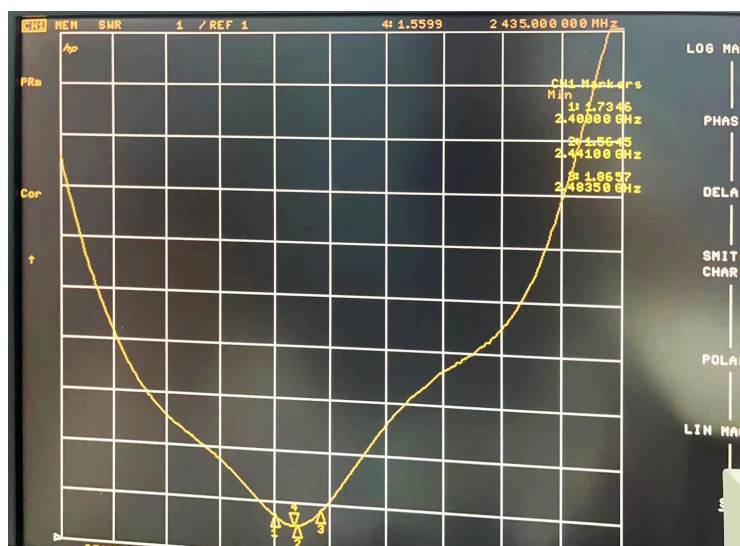
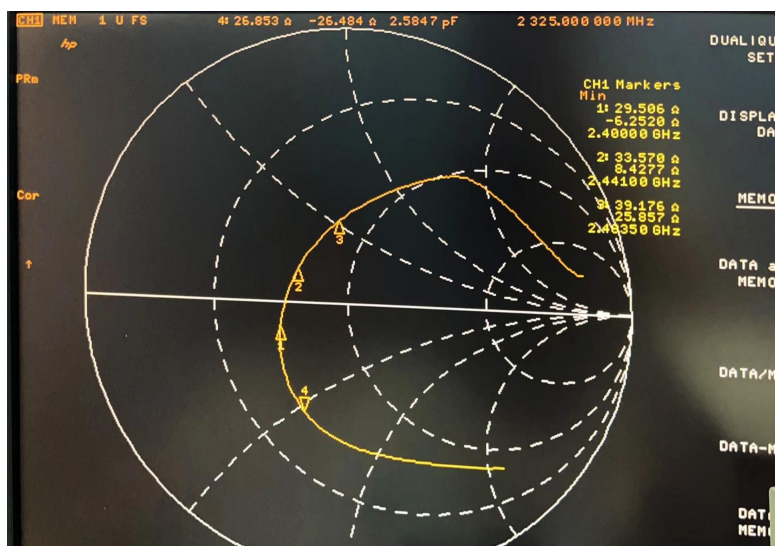

04 F5-Testing

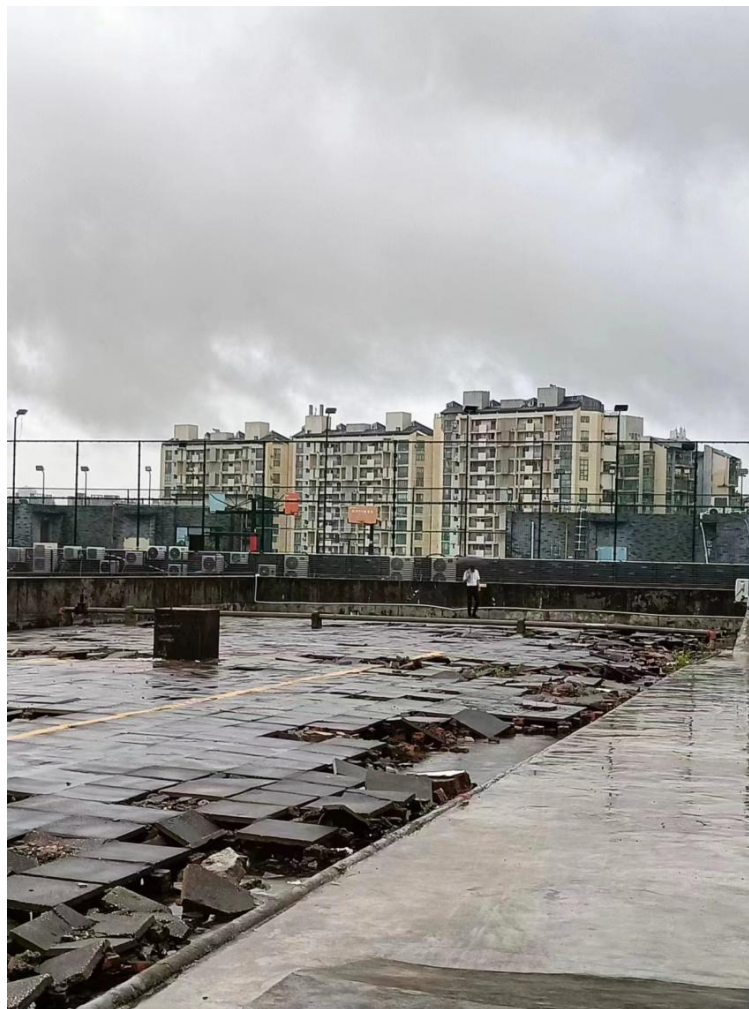

测试设备： iPhone6

测试环境： 顶楼空旷无遮挡

测试方法： 直线，360°转身

测试次数： 换人测试3次

实测效果：

近身捂双耳，直线距离12米

05 F5-OTA测试-L/R

F5 (L自由空间)		
Chan信道	TRP功率 (dBm)	TIS灵敏度 (dBm)
0	-1.05	-75.14
39	-1.31	-77.87
78	-1.39	-77.98

F5 (R自由空间)		
Chan信道	TRP功率 (dBm)	TIS灵敏度 (dBm)
0	-5.78	-71.99
39	-3.91	-74.7
78	-3.23	-75.2

06

F5-OTA测试方向图-L/R

F5-有源方向图- (L自由空间)

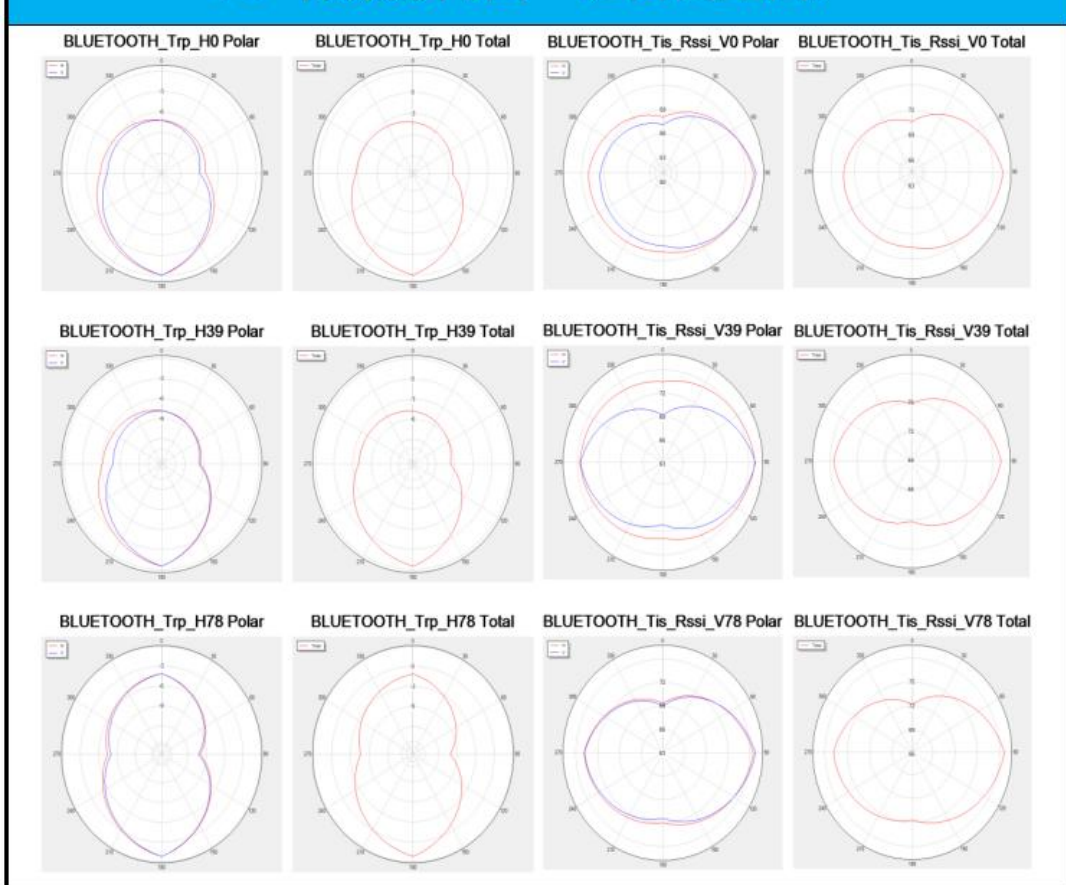

F5-有源方向图- (R自由空间)

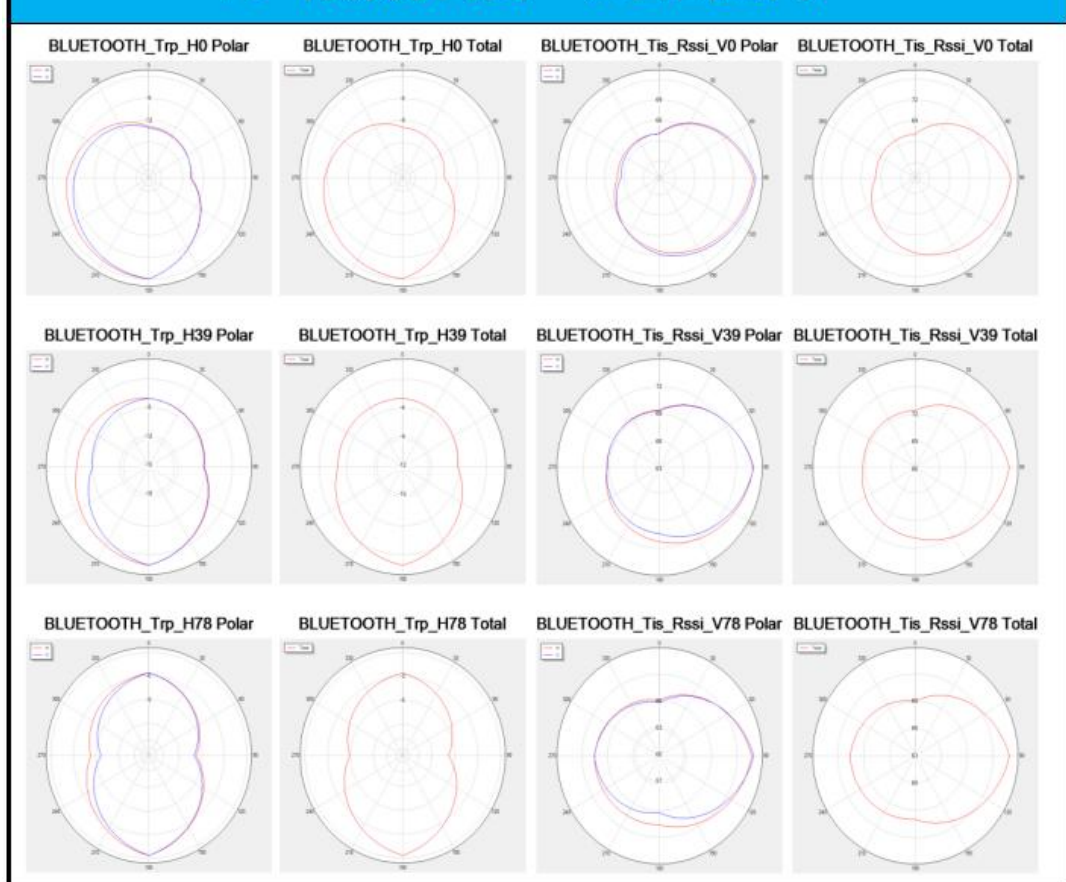

07 F5-L/R效率与增益

F5-L-效率与增益

Frequency (MHz)	Efficiency (%)	percentage (%)	Gain (dBi)
2400	-9.14	12.18%	-3.37
2425	-8.83	13.08%	-3.28
2450	-7.41	18.15%	-2.05
2475	-7.47	17.89%	-2.75
2500	-7.7	16.98%	-2.51

F5-R-效率与增益

Frequency (MHz)	Efficiency (%)	percentage (%)	Gain (dBi)
2400	-7.38	18.29%	0.4
2425	-6.62	21.77%	1.04
2450	-5.92	25.6%	1.43
2475	-6.2	23.97%	0.43
2500	-6.64	21.68%	-0.12

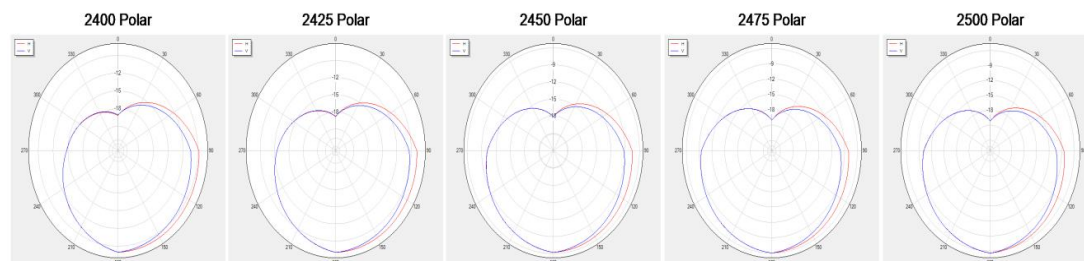
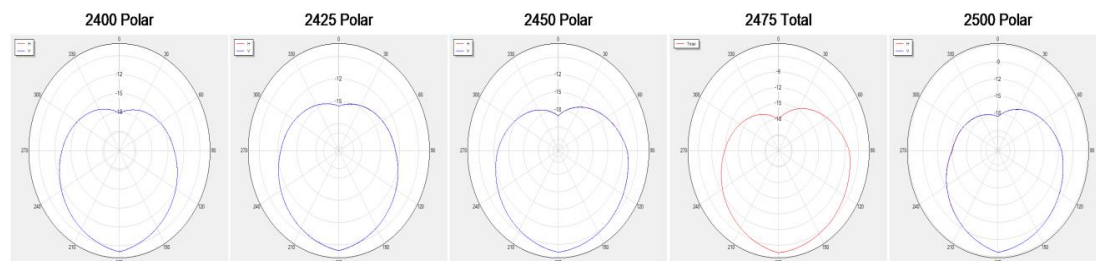



www.szpbxy.com

深圳市朋伴兴业科技有限公司

深圳市龙华区民治街道民治社区1970科技园4栋608室

Thank You!



集研发，制造，销售为一体
专注天线领域的研发与应用