



东莞市一佳电子通讯有限公司

Dongguan YiJia Electronics Communication Technology Co., Ltd.

Antenna Test Report

- 1. Antenna Profile***
- 2. Antenna Passive Test***
- 3. Antenna WiFi Test***

Tester : Tang Guohao

Approval : Chen Guoqiang

Date : 2023 / 08 / 21

东莞市一佳电子通讯科技有限公司 深圳研发中心

Address: No. 59, MuYu Road, ShaTou Community, ChangAn Town, Dongguan City, GuangDong

Tel:0755-26462487



天线规格

Antenna Specification

Electrical Properties

Frequency	2.4-2.5GHz
Impedance	50 Ohm Nominal
V.S.W.R	2.0 Max
Gain	3.6 dBi
Type	Internal antenna
Polarization	Linear

Physical Properties

Connector	1代IPEX
Cable Type	O.D.1.13mm
Cable Length	60mm
Cable Color	Black
Operating Temp.	-40 ~ +85 °C
Storage Temp / Humidity	25±5°C / <70%

RoHS

Compliant

CUSTOMER	
PART NO	

REV.	DESCRIPTION	DATE
△	首次发行	2022-07-26
△	修改线长	2022-08-16

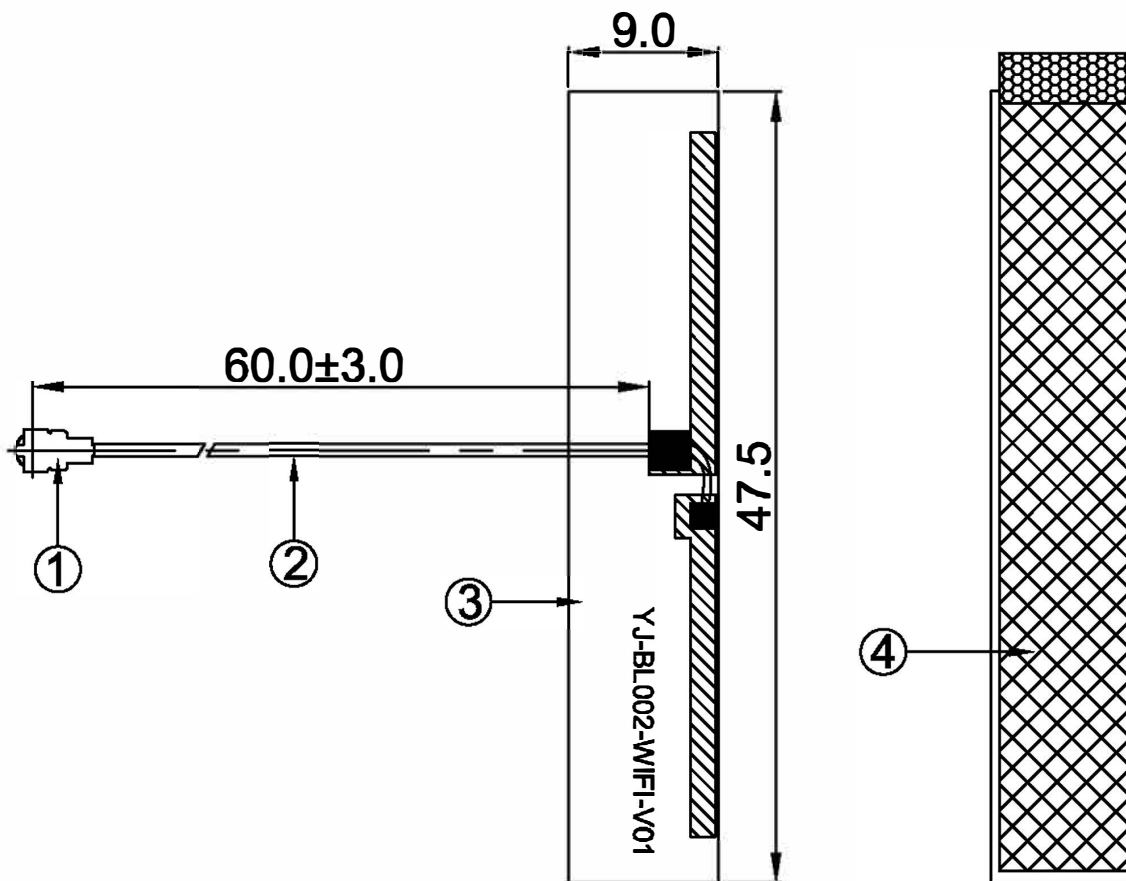

4	Paster	46.0*8.0MM	3M	PAS10162A.P01	1
3	PCB	47.5*9.0*0.6MM	PCB	PCB100XXA.P01	1
2	Coaxial Cable	O.D.1.13 Black	O.D.1.13	COA100XXA.P01	1
1	Mini Connector	Au Plated 1代	Cu	TER100XXA.P01	1
NO	PART NAME	DESCRIPTION	Material	Part	Q.TY



东莞市一佳电子通讯科技有限公司

Dongguan YiJia Electronics Communication Technology Co.,Ltd. Tel:0769-82586086 Fax:0769-82586086

PART NAME: WIFI Antenna L=60MM MHF			
PART NO.: YJT01.226.002.301A			DATE: 2022-08-16
APPROVED BY	CHECKED BY	DESIGNED BY	 Tolerance X.X ±0.50 X.XX±0.15 X° ±3°
王业昕	邓磊	廖光喜	
UNITS: mm SCALE: 1/1 REVISION: B			



1. Antenna Profile

*WiFi
Antenna*

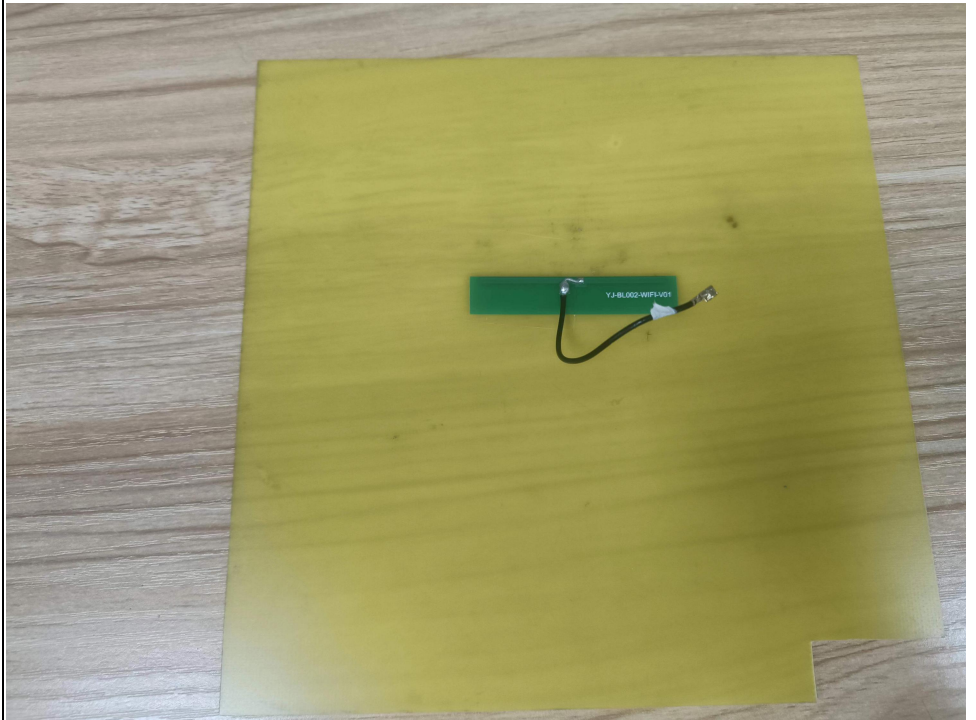



2. Antenna Passive Test

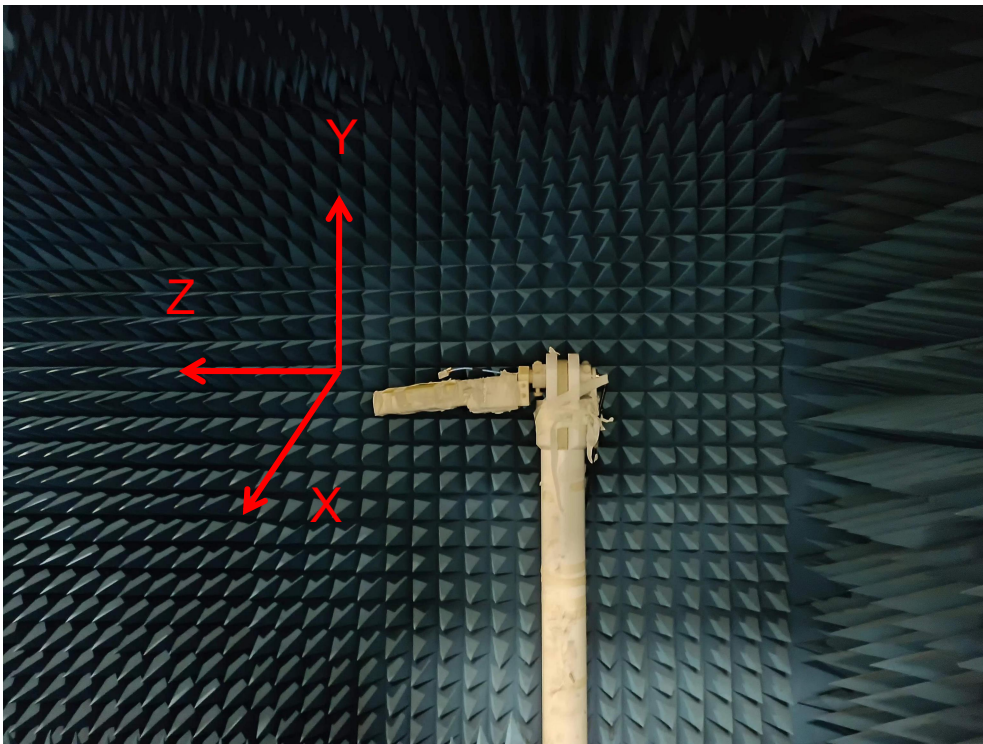
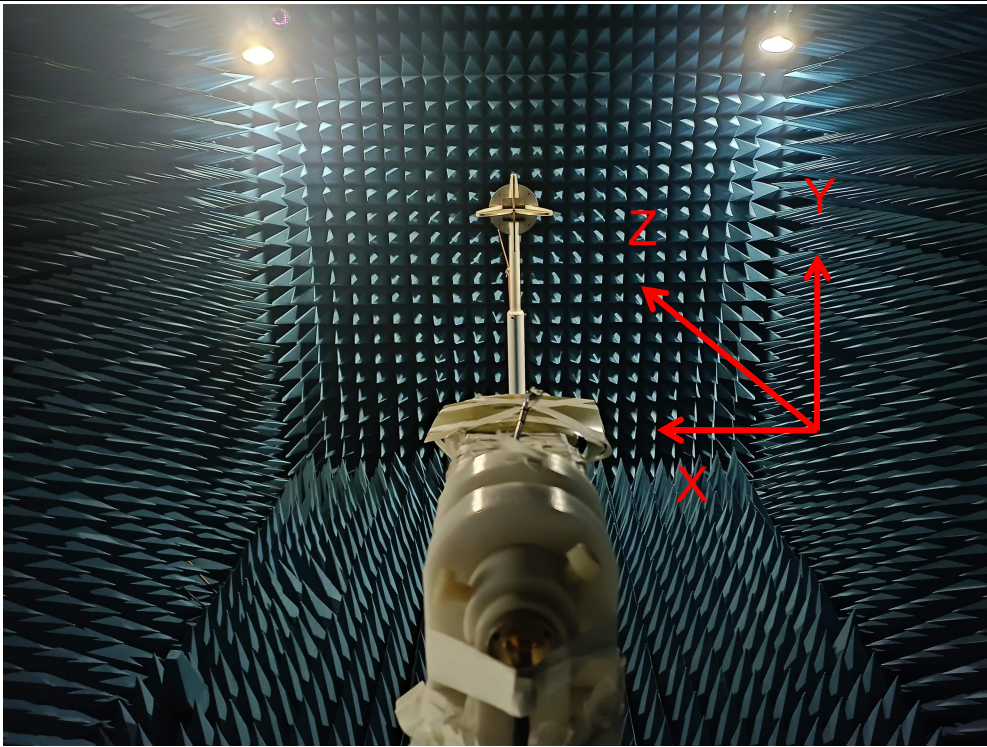



3. Antenna WiFi Test

**Agilent
E5071B**

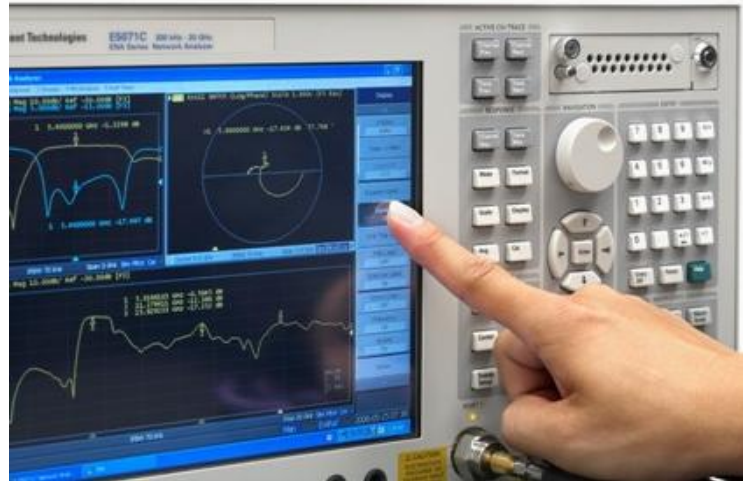

**S
Parameter
Test //
WiFi
Antenna**

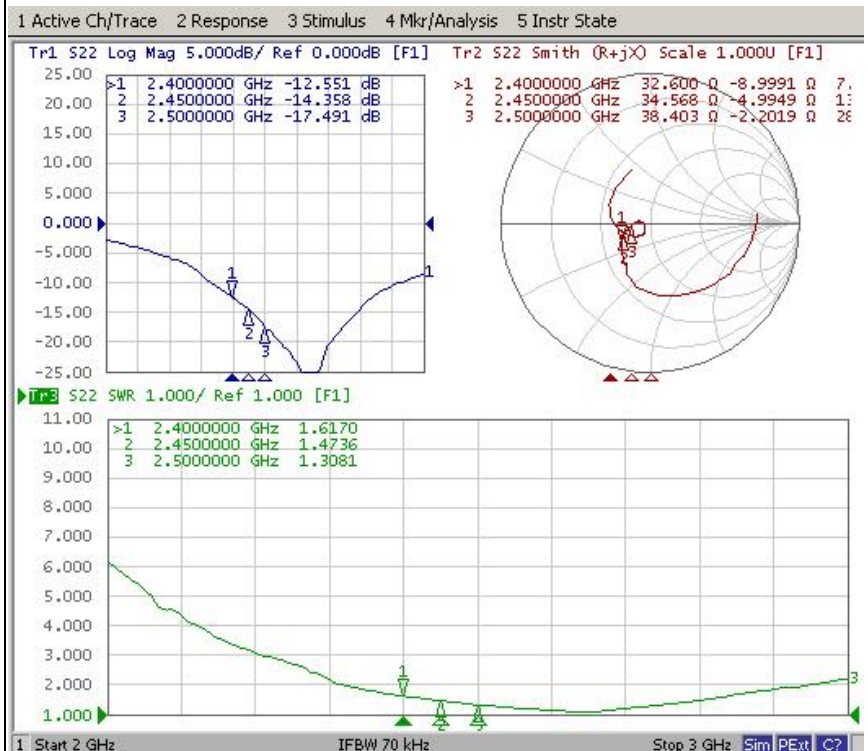



Passive Test For WiFi Antenna

Freq (MHz)	Effi (%)	Effi (dB)	Gain (dBi)
2400	55.2	-2.6	2.3
2410	56.2	-2.5	2.4
2420	57.7	-2.4	2.7
2430	57.5	-2.4	2.9
2440	57.7	-2.4	3.2
2450	61.2	-2.1	3.6
2460	69.7	-1.6	3.5
2470	70.5	-1.5	3.4
2480	79.1	-1.0	3.2
2490	79.2	-1.0	2.7
2500	79.7	-1.0	2.6



Radiation Pattern For WiFi Antenna

2400.000MHz

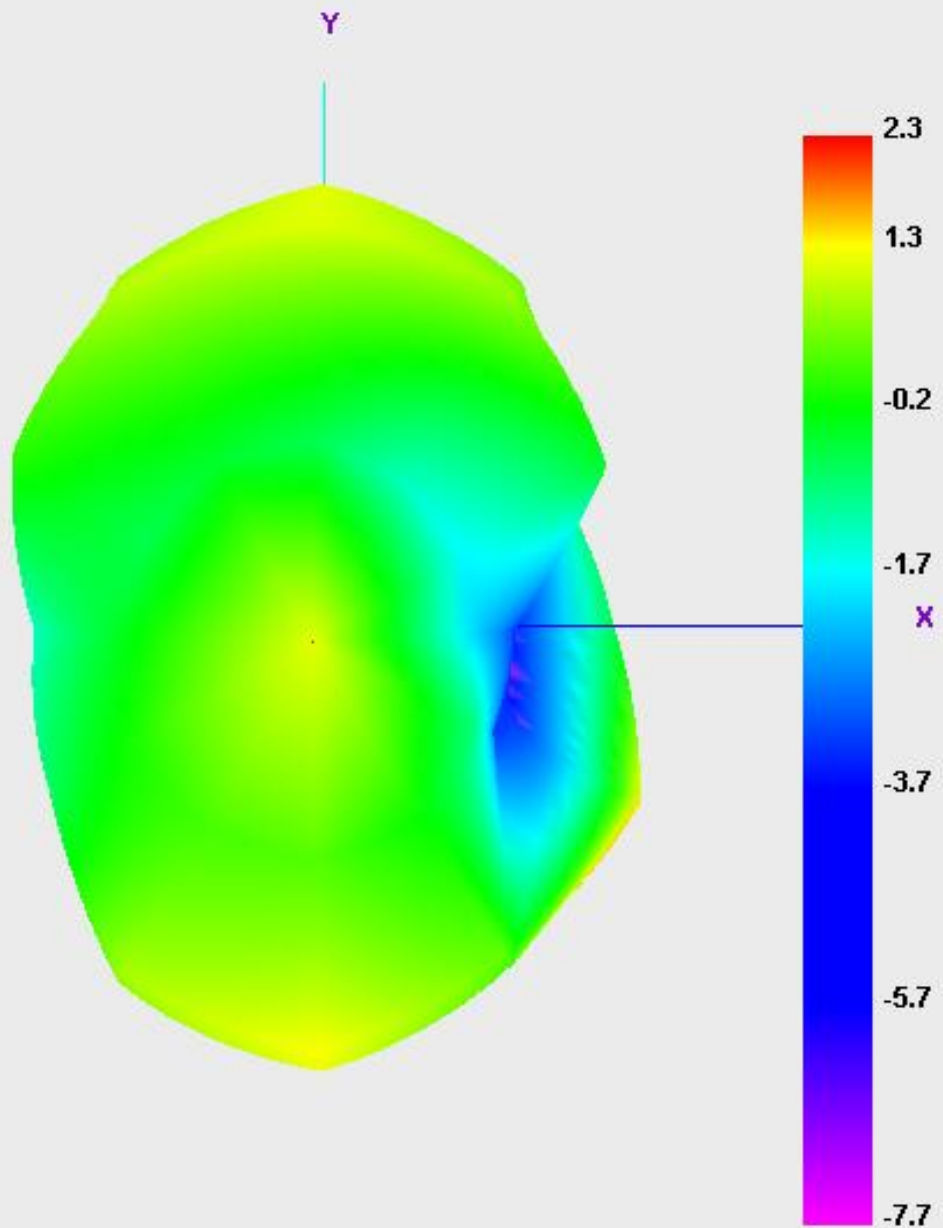



Radiation Pattern For WiFi Antenna

2450.000MHz

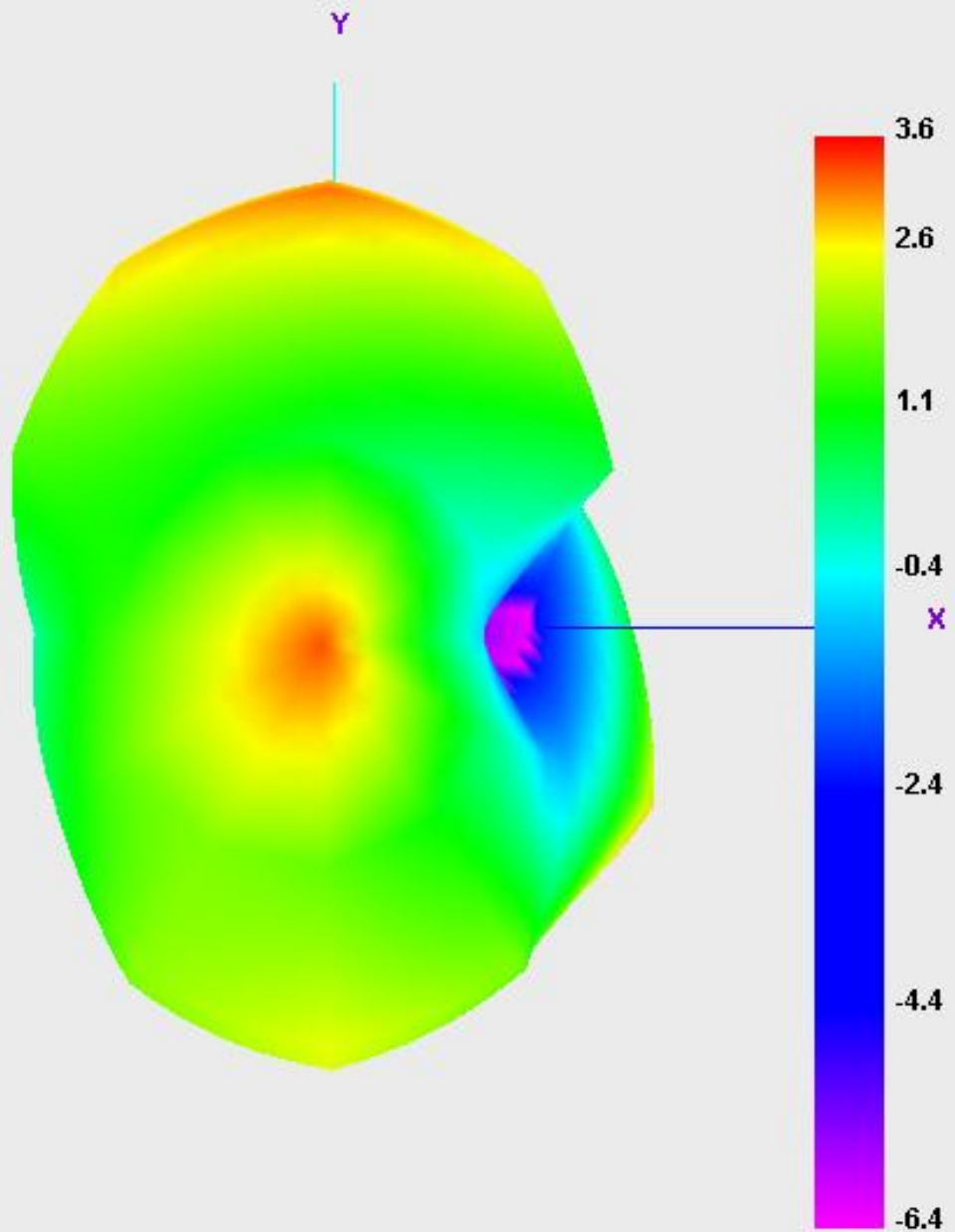



Radiation Pattern For WiFi Antenna

2500.000MHz

