

# Antenna Specification

## 1. Antenna type: PCB antenna

Manufacturer: Yanshan Xingao Electronic Technology Co., Ltd.

Tested by: Yanshan Xingao Electronic Technology Co., Ltd.

## 2. Antenna design:

The unit of length in the figure below is mm.

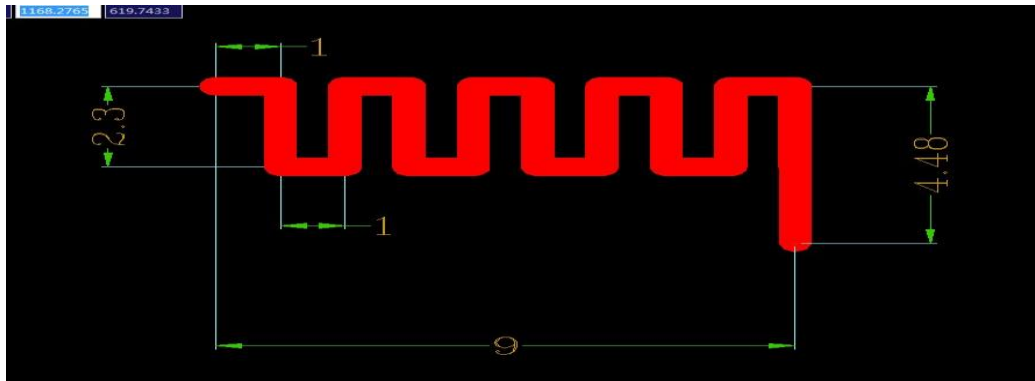

### 3. Antenna gain:

Frequency	Efficiency / %	Gain/ dB
2400MHz	18.11	1.34
2410MHz	19.68	1.75
2420MHz	21.09	2.14
2430MHz	23.17	2.63
2440MHz	22.65	2.49
2450MHz	24.49	2.95
2460MHz	24.38	2.71
2470MHz	26.24	2.97
2480MHz	25	2.66
2490MHz	26.98	2.78
2500MHz	25.94	2.44

## 4. Radiation Pattern for 2.4G antenna

Phi 0° 2D

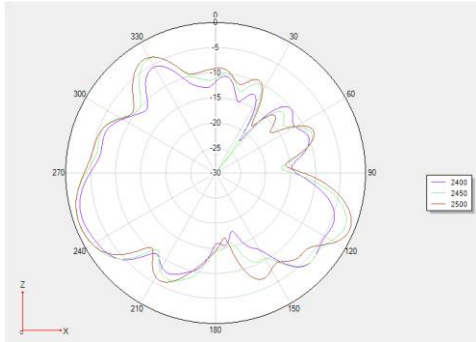

Phi 90° 2D

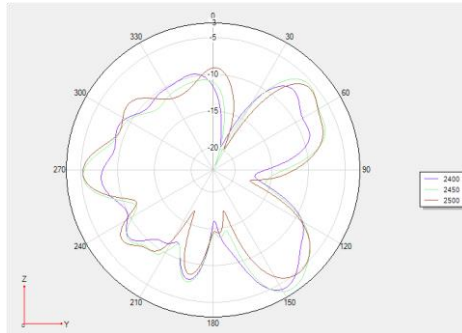

Theta 90° 2D

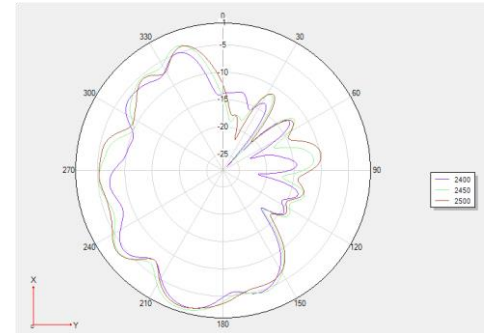

2400

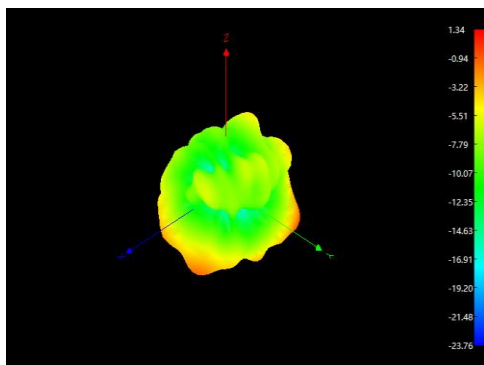

2450

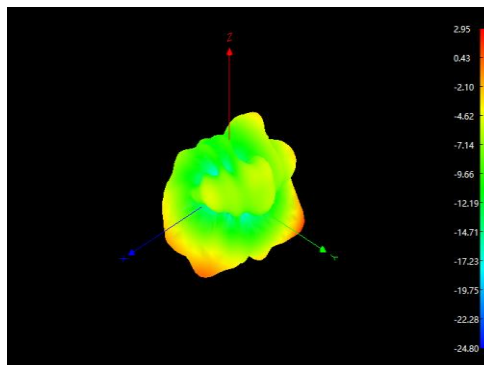

2500

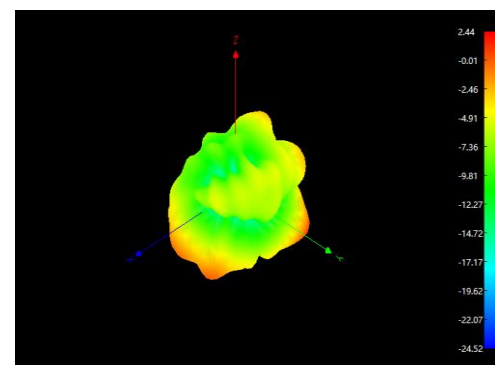

## 5. Antenna performance



## 6. Antenna matching circuit

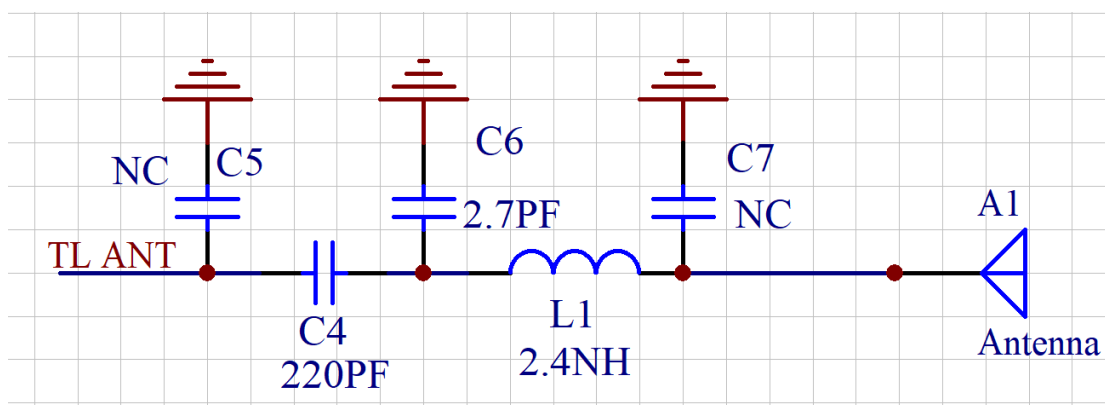

## 7. Antenna passive test

