



Shenzhen Global Test Service Co.,Ltd.

No.7-101 and 8A-104, Building 7 and 8, DCC Cultural and Creative Garden, No.98, Pingxin North Road, Shangmugu Community, Pinghu Street, Longgang District, Shenzhen, Guangdong

FCC PART 15 SUBPART C TEST REPORT

FCC PART 15.407

Report Reference No. : **GTS20221215006-1-5**

FCC ID. : **2A6HB-X20L**

Compiled by

(position+printed name+signature) . : File administrators Peter Xiao

Supervised by

(position+printed name+signature) . : Test Engineer Jenny Zeng

Approved by

(position+printed name+signature) . : Manager Jason Hu



Date of issue : Feb.17, 2023

Representative Laboratory Name : **Shenzhen Global Test Service Co.,Ltd**

Address : No.7-101 and 8A-104, Building 7 and 8, DCC Cultural and Creative Garden, No.98, Pingxin North Road, Shangmugu Community, Pinghu Street, Longgang District, Shenzhen, Guangdong

Applicant's name : **Shenzhen Youth Song Education Technology Co.,Ltd**

Address : 1102C2, BLDG E4, TCL Science Park, NO.1001 Zhongshanyuan RD, Xili ST, Nanshan DIST, Shenzhen, China

Test specification..... :

Standard : **FCC Part 15.407: UNLICENSED NATIONAL INFORMATION INFRASTRUCTURE DEVICES**

TRF Originator : Shenzhen Global Test Service Co.,Ltd.

Master TRF : Dated 2014-12

Shenzhen Global Test Service Co.,Ltd. All rights reserved.

This publication may be reproduced in whole or in part for non-commercial purposes as long as the Shenzhen Global Test Service Co.,Ltd. is acknowledged as copyright owner and source of the material. Shenzhen Global Test Service Co.,Ltd. takes no responsibility for and will not assume liability for damages resulting from the reader's interpretation of the reproduced material due to its placement and context.

Test item description..... : **Tablet**

Trade Mark..... : N/A

Manufacturer : Shenzhen Youth Song Education Technology Co.,Ltd

Model/Type reference : X20L

Listed Models : N/A

Modulation Type : DSSS,OFDM

Operation Frequency : From 5260MHz to 5320MHz, 5500MHz to 5700MHz

Rating..... : DC 3.8V by battery
Recharged by DC 5.0V

Result..... : **PASS**

TEST REPORT

Test Report No. :	GTS20221215006-1-5	Jul. 29, 2022
		Date of issue

Equipment under Test : Tablet

Model /Type : X20L

Listed Models : N/A

Applicant : **Shenzhen Youth Song Education Technology Co.,Ltd**

Address : 1102C2, BLDG E4, TCL Science Park, NO.1001 Zhongshanyuan RD,
Xili ST, Nanshan DIST, Shenzhen, China

Manufacturer : **Shenzhen Youth Song Education Technology Co.,Ltd**

Address : 1102C2, BLDG E4, TCL Science Park, NO.1001 Zhongshanyuan RD,
Xili ST, Nanshan DIST, Shenzhen, China

Test Result:	PASS
---------------------	-------------

The test report merely corresponds to the test sample.

It is not permitted to copy extracts of these test result without the written permission of the test laboratory.

Contents

1. TEST STANDARDS	4
2. SUMMARY	5
2.1. General Remarks	5
2.2. Product Description	5
2.3. Equipment Under Test	5
2.4. Short description of the Equipment under Test (EUT)	6
2.5. EUT operation mode	6
2.6. Block Diagram of Test Setup	7
2.7. Related Submittal(s) / Grant (s)	7
2.8. Special Accessories	7
2.9. Modifications	7
2.10. Conducted Output Power and EIRP	7
2.11. TEST METHODOLOGY	8
2.12. SYSTEM TEST CONFIGURATION	8
2.12.1. Justification	8
2.13. Procedure	8
3. TEST ENVIRONMENT	9
3.1. Address of the test laboratory	9
3.2. Test Facility	9
3.3. Environmental conditions	9
3.4. Test Description	9
3.5. Statement of the measurement uncertainty	9
3.6. Equipments Used during the Test	10
4. DESCRIPTION OF DYNAMIC FREQUENCY SELECTION TEST	11
4.1. Requirements	11
4.2. Limit	11
5. DFS DETECTION THRESHOLD VALUES	12
6. DFS TEST SIGNALS	13
7. TEST RESULT	17
8. TEST SETUP PHOTOS OF THE EUT	25
9. EXTERNAL AND INTERNAL PHOTOS OF THE EUT	25

1. TEST STANDARDS

The tests were performed according to following standards:

[FCC Rules Part 15.407](#): UNLICENSED NATIONAL INFORMATION INFRASTRUCTURE DEVICES.

[ANSI C63.10-2013](#): American National Standard for Testing Unlicensed Wireless Devices

[KDB 789033 D02](#): GUIDELINES FOR COMPLIANCE TESTING OF UNLICENSED NATIONAL INFORMATION INFRASTRUCTURE (U-NII) DEVICES PART 15, SUBPART E

2. SUMMARY

2.1. General Remarks

Date of receipt of test sample	:	Dec. 16, 2022
Testing commenced on	:	Dec. 16, 2022
Testing concluded on	:	Feb. 16, 2023

2.2. Product Description

Product Name:	Tablet
Trade Mark:	N/A
Model/Type reference:	X20L
List Model:	N/A
Model Declaration	N/A
Power supply:	DC 3.8V by battery Recharged by DC 5.0V
Hardware Version	N/A
Software Version	N/A
Sample ID	GTS20221215006-1-S0001-1#>S20221215006-1-S0001-2#
Bluetooth	
Frequency Range	2402MHz ~ 2480MHz
Channel Number	79 channels for Bluetooth (DSS) 40 channels for Bluetooth (DTS)
Channel Spacing	1MHz for Bluetooth (DSS) 2MHz for Bluetooth (DTS)
Modulation Type	GFSK, $\pi/4$ -DQPSK for Bluetooth (DSS) GFSK for Bluetooth (DTS)
2.4GWLAN	
WLAN Operation frequency	IEEE 802.11b:2412-2462MHz IEEE 802.11g:2412-2462MHz IEEE 802.11n HT20:2412-2462MHz IEEE 802.11n HT40:2422-2452MHz
WLAN Modulation Type	IEEE 802.11b: DSSS(CCK,DQPSK,DBPSK) IEEE 802.11g: OFDM(64QAM, 16QAM, QPSK, BPSK) IEEE 802.11n HT20: OFDM (64QAM, 16QAM, QPSK,BPSK) IEEE 802.11n HT40: OFDM (64QAM, 16QAM, QPSK,BPSK)
Channel number:	11 Channel for IEEE 802.11b/g/n(HT20) 7 Channel for IEEE 802.11n(HT40)
Channel separation:	5MHz
WIFI(5.2G/5.3G/5.7G Band)	
Frequency Range	5180MHz ~ 5240MHz, 5260MHz ~ 5320MHz, 5500MHz ~ 5700MHz
Channel Number	4 Channels for 20MHz bandwidth(5180-5240MHz) 4 Channels for 20MHz bandwidth(5260-5320MHz) 11 Channels for 20MHz bandwidth(5500-5700MHz) 2 channels for 40MHz bandwidth(5190~5230MHz) 2 channels for 40MHz bandwidth(5270~5310MHz) 5 Channels for 40MHz bandwidth(5510-5670MHz) 1 channels for 80MHz bandwidth(5210MHz) 1 channels for 80MHz bandwidth(5290MHz) 2 Channels for 80MHz bandwidth(5530-5610MHz)
Modulation Type	802.11a/n/ac: OFDM
WIFI (5.8G Band)	
Frequency Range	5745MHz ~ 5825MHz
Channel Number	5 channels for 20MHz bandwidth(5745-5825MHz) 2 channels for 40MHz bandwidth(5755~5795MHz) 1 channels for 80MHz bandwidth(5775MHz)
Modulation Type	802.11a/n/ac: OFDM

Antenna Description	Internal Antenna, 2.00dBi(Max.) for 2.4G Band and 2.00dBi(Max.) for 5G Band
---------------------	---

2.3. Equipment Under Test

Power supply system utilised

Power supply voltage	:	<input type="radio"/> 230V / 50 Hz	<input type="radio"/> 120V / 60Hz
		<input type="radio"/> 12 V DC	<input type="radio"/> 24 V DC
		<input checked="" type="radio"/> Other (specified in blank below)	

DC 3.8 V

2.4. Short description of the Equipment under Test (EUT)

This is a Tablet.

For more details, refer to the user’s manual of the EUT.

2.5. EUT operation mode

The application provider specific test software to control sample in continuous TX and RX.

IEEE 802.11a/ac20/ac40/ac80/n20/n40:

U-NI-2A		U-NI-2A		U-NI-2A	
Channel	Frequency (MHz)	Channel	Frequency (MHz)	Channel	Frequency (MHz)
52	5260	54	5270	58	5290
56	5280	62	5310		
60	5300				
64	5320				

U-NI-2C		U-NI-2C		U-NI-2C	
Channel	Frequency (MHz)	Channel	Frequency (MHz)	Channel	Frequency (MHz)
100	5500	102	5510	106	5530
104	5520	110	5550	122	5610
108	5540	118	5590		
112	5560	126	5630		
116	5580	134	5670		
120	5600				
124	5620				
128	5640				
132	5660				
136	5680				
140	5700				

2.6. Block Diagram of Test Setup

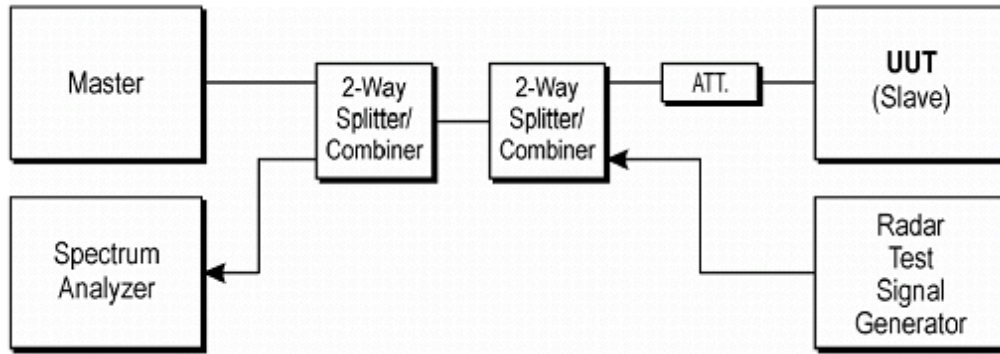

Figure 7-1. Test Setup

2.7. Related Submittal(s) / Grant (s)

This submittal(s) (test report) is intended for **FCC ID: 2A6HB-X20L** filing to comply with Section 15.407 of the FCC Part 15, Subpart E Rules.

2.8. Special Accessories

Manufacturer	Description	Model	Serial Number	Certificate
DongGuan XunTuo Technology Co.,Ltd	Adapter	XTA10W0502000U1	--	SDOC

2.9. External I/O Cable

I/O Port Description	Quantity	Cable
DC IN Port	1	1.2M, Unscreened Cable
Earphone Port	1	N/A

2.10. Modifications

No modifications were implemented to meet testing criteria.

2.11. Conduced Output Power and EIRP

Mode	Frequency Band (MHz)	Maximum Conducted Output Power (dBm)	Antenna Gain (dBi)	Maximum EIRP (dBm)	Maximum EIRP (mW)
IEEE 802.11a	5260 – 5320	7.70	2.00	9.70	9.33
	5500 – 5700	6.80	2.00	8.80	7.59
IEEE 802.11n HT20	5260 – 5320	7.39	2.00	9.39	8.69
	5500 – 5700	6.79	2.00	8.79	7.57
IEEE 802.11n HT40	5260 – 5320	7.45	2.00	9.45	8.81
	5500 – 5700	6.78	2.00	8.78	7.55
IEEE 802.11ac VHT20	5260 – 5320	7.45	2.00	9.45	8.81
	5500 – 5700	6.60	2.00	8.60	7.24
IEEE 802.11ac VHT40	5260 – 5320	7.47	2.00	9.47	8.85
	5500 – 5700	6.79	2.00	8.79	7.57
IEEE 802.11ac VHT80	5260 – 5320	7.00	2.00	9.00	7.94
	5500 – 5700	6.46	2.00	8.46	7.01

Remark:

1. A TPC mechanism is not required for systems with an e.i.r.p. of less than 500 mW;

2.12. TEST METHODOLOGY

This report has been prepared to demonstrate compliance with the requirements for Dynamic Frequency Selection (DFS) as stated in FCC CFR 47 PART 15E(15.407). Testing was performed in accordance with the measurement procedure described in FCC KDB 905462 D02 v02

2.13. SYSTEM TEST CONFIGURATION

2.12.1. Justification

1. Connect FCC approved Master AP to a network, via wired Ethernet, that allows connection to an FTP server.
2. Associate the EUT with the Master AP.
3. Launch the FTP application on the EUT.
4. Connect to the FTP server application to the FTP server hosting the file
5. Initiate an FTP download of the file from the host.
6. Monitor the channel loading during transfer.
7. Reduce the maximum allowed data rate for the Master AP, using the AP's GUI interface.
8. Repeat steps 4-6 until the channel loading is as close to 20 % as possible.
9. Record the data rate setting on the Master AP and the channel loading.
10. While the system is performing an FTP transfer using the settings from item 8 above, perform the Channel Closing Transmission Time and Channel Move Time Measurements as required by KDB905462 D02 v02 using a conducted test.

2.14. Procedure

The KDB905462 D02 v02 describes a conducted test setup. Each one channel selected between bands 2, band 3 is chosen for the testing.

1. The radar pulse generator is setup to provide a pulse at the frequency that the Master and Client are operating. A Type 0 radar pulse with a 1 μ s pulse width and a 1428 μ s PRI is used for the testing.
2. The vector signal generator is adjusted to provide the radar burst (18 pulses) at a level of approximately -62 dBm at the antenna of the Master device.
3. The Client Device (EUT) is set up per the diagram in Figure 3-1 and communications between the Master device and the Client is established.
4. The MPEG file specified by the FCC ("6½ Magic Hours") is streamed from the "file computer" through the Master to the Slave Device and played in full motion video using Media Player Classic Ver.6.4.8.6 in order to properly load the network.
5. The spectrum analyzer is set to record about 15 sec window to any transmissions occurring up to and after 10 sec.
6. The system is again setup and the monitoring time is shortened in order to capture the Channel Closing Transmission Time. This time is measured to insure that the Client ceases transmission within 200 ms and the aggregate of emissions occurring after 200 ms up to 10 sec do not exceed 60 ms.

(Note: the channel may be different since the Master and Client have changed channels due to the detection of the initial radar pulse.)
7. After the initial radar burst the channel is monitored for 30 minutes to insure no transmissions or beacons occur. A second monitoring setup is used to verify that the Master and Client have both moved to different channels.

3. TEST ENVIRONMENT

3.1. Address of the test laboratory

Shenzhen Global Test Service Co.,Ltd.

No.7-101 and 8A-104, Building 7 and 8, DCC Cultural and Creative Garden, No.98, Pingxin North Road, Shangmugu Community, Pinghu Street, Longgang District, Shenzhen, Guangdong

3.2. Test Facility

The test facility is recognized, certified, or accredited by the following organizations:

CNAS (No. CNAS L8169)

Shenzhen Global Test Service Co., Ltd. has been assessed and proved to be in compliance with CNAS-CL01 Accreditation Criteria for Testing and Calibration Laboratories (identical to ISO/IEC 17025: 2019 General Requirements) for the Competence of Testing and Calibration Laboratories.

A2LA (Certificate No. 4758.01)

Shenzhen Global Test Service Co., Ltd. has been assessed by the American Association for Laboratory Accreditation (A2LA). Certificate No. 4758.01.

Industry Canada Registration Number. is 24189.

FCC Designation Number is CN1234.

FCC Registered Test Site Number is165725.

3.3. Environmental conditions

During the measurement the environmental conditions were within the listed ranges:

Temperature:	15-35 ° C
Humidity:	30-60 %
Atmospheric pressure:	950-1050mbar

3.4. Test Description

Applied Standard: FCC CFR 47 PART 15.407			
Requirement	Operational Mode		RESULTS
	Master	Client	
Non-Occupancy Period	Yes	Yes	Pass
DFS Detection Threshold	Yes	Not required	Not required
Channel Availability Check Time	Yes	Not required	Not required
Channel Closing Transmission Time	Yes	Yes	Pass
Channel Move Time	Yes	Yes	Pass
U-NII Detection Bandwidth	Yes	Not required	Not required

3.5. Statement of the measurement uncertainty

No.	Item	Uncertainty
1	DFS Threshold (radiated)	±1.50dB
2	DFS Threshold (conducted)	±1.45dB
3	Temperature	±0.5°C
4	Humidity	±2%

3.6. Equipments Used during the Test

Test Equipment	Manufacturer	Model No.	Serial No.	Calibration Date	Calibration Due Date
Wireless AP (Master Device)	SAMSUNG ELECTRONICS	WEA453e	S2LF812265 (FCC ID:A3LWEA453E)	2022/09/09	2023/09/08
Measurement System(S/G)	ADLINK	PXI/DFS	302581/735	2022/09/09	2023/09/08
Measurement System(S/G)	ADLINK	PXI/DFS	303582/113	2022/09/09	2023/09/08
Spectrum Analyzer	Agilent	N9020A	MY48010425	2022/09/09	2023/09/08
Power Divider	Hewlett Packard	11636B	0531	2022/09/09	2023/09/08
Power Splitter	Hewlett Packard	11667B	05001	2022/09/09	2023/09/08
Attenuator(10 dB)	Agilent	8493C	07560	2022/09/09	2023/09/08
Attenuator(3 dB)	WEINSCHEL	2-3	BR0617	2022/09/09	2023/09/08
Step Attenuator	Weinschel	AF9003-69-31	5701	2022/09/09	2023/09/08
4 Way Power Divider	Cernex	CDPU5260404 K	14695	2022/09/09	2023/09/08
4 Way Power Divider	Narda	4426-4	11927	2022/09/09	2023/09/08

Note: The Cal.Interval was one year.

4. DESCRIPTION OF DYNAMIC FREQUENCY SELECTION TEST

4.1. Requirements

KDB905462 D02 v02 (04/08/2016) the following are the requirements for Client Devices:

- 1) A Client Device will not transmit before having received appropriate control signals from a Master Device.
- 2) A Client Device will stop all its transmissions whenever instructed by a Master Device to which it is associated and will meet the Channel Move Time and Channel Closing Transmission Time requirements. The Client Device will not resume any transmissions until it has again received control signals from a Master Device.
- 3) If a Client Device is performing In-Service Monitoring and detects a Radar Waveform above the DFS Detection Threshold, it will inform the Master Device. This is equivalent to the Master Device detecting the Radar Waveform and d) through f) of section 5.1.1 (KDB905462 D02 v02) apply.
- 4) Irrespective of Client Device or Master Device detection the Channel Move Time and Channel Closing Transmission Time requirements remain the same.

4.2. Limit

Parameter	Value
Non-occupancy period	Minimum 30 minutes
Channel Availability Check Time	60 seconds
Channel Move Time	10 seconds See Note 1.
Channel Closing Transmission Time	200 milliseconds + an Aggregate of 60 milliseconds over Remaining 10 second period. See Notes 1 and 2.
U-NII Detection Bandwidth	Minimum 100 % of the U-NII 99 % transmission power bandwidth. See Note 3.

Note 1: Channel Move Time and the Channel Closing Transmission Time should be performed with Radar Type 0. The measurement timing begins at the end of the Radar Type 0 burst.

Note 2: The Channel Closing Transmission Time is comprised of 200 milliseconds starting at the beginning of the Channel Move Time plus any additional intermittent control signals required to facilitate a Channel move (an aggregate of 60 milliseconds) during the remainder of the 10 second period. The aggregate duration of control signals will not count quiet periods in between transmissions.

Note 3: During the U-NII Detection Bandwidth detection test, radar type 0 should be used. For each frequency step the minimum percentage of detection is 90 percent. Measurements are performed with no data traffic.

5. DFS detection threshold values

The DFS detection thresholds are defined for Master devices and Client Devices with In-service monitoring. These detection thresholds are listed in the following table.

Maximum Transmit Power	Value (See Notes 1 and 2)
EIRP ≥ 200 milliwatt	-64 dBm
EIRP < 200 milliwatt and Power spectral < 10 dBm/MHz	-62 dBm
EIRP < 200 milliwatt that do not meet the power spectral density requirement	-64 dBm

Note 1: This is the level at the input of the receiver assuming a 0 dBi receive antenna.

Calibration:

The EUT is slave equipment with a minimum gain is 2.00dBi;

For a detection threshold level of -62dBm and the master (Brand: Samsung), Model: S2LF812265, FCC ID: A3LWEA453E) antenna gain is 3.0 dBi, required detection threshold is -59.00 dBm (=-62+3.0)

Maximum transmit power is less than 200 milliwatt in this report, so detection threshold level is -62dBm.

Note 2: Throughout these test procedures an additional 1 dB has been added to the amplitude of the test transmission waveforms to account for variations in measurement equipment. This will ensure that the test signal is at or above the detection threshold level to trigger a DFS response.

Note 3: EIRP is based on the highest antenna. For MIMO devices refer to KDB Publication 662911 D01.

6. DFS test signals

As the EUT is a Client Device with no Radar Detection only one type radar pulse is required for the testing. Radar Pulse type 0 was used in the evaluation of the Client device for the purpose of measuring the Channel Move Time and the Channel Closing Transmission Time.

Table 5 – Short Pulse Radar Test Waveforms

Radar Type	Pulse Width (μsec)	PRI (μsec)	Number of Pulses	Minimum Percentage of Successful Detection	Minimum Number of Trials
0	1	1428	18	See Note 1	See Note 1
1	1	Test A: 15 unique PRI values randomly selected from the list of 23 PRI values in Table 5a	Roundup $\left\{ \begin{matrix} \left(\frac{1}{360} \right) \cdot \\ \left(\frac{19 \cdot 10^6}{\text{PRI}_{\mu\text{sec}}} \right) \end{matrix} \right\}$	60%	30
		Test B: 15 unique PRI values randomly selected within the range of 518-3066 μsec, with a minimum increment of 1 μsec, excluding PRI values selected in Test A			
2	1-5	150-230	23-29	60%	30
3	6-10	200-500	16-18	60%	30
4	11-20	200-500	12-16	60%	30
Aggregate (Radar Types 1-4)				80%	120
Note 1: Short Pulse Radar Type 0 should be used for the detection bandwidth test, channel move time, and channel closing time tests.					

A minimum of 30 unique waveforms are required for each of the Short Pulse Radar Types 2 through 4. If more than 30 waveforms are used for Short Pulse Radar Types 2 through 4, then each additional waveform must also be unique and not repeated from the previous waveforms. If more than 30 waveforms are used for Short Pulse Radar Type 1, then each additional waveform is generated with Test B and must also be unique and not repeated from the previous waveforms in Tests A or B.

Table 6 – Long Pulse Radar Test Waveform

Radar Type	Pulse Width (μsec)	Chirp Width (MHz)	PRI (μsec)	Number of Pulses per Burst	Number of Bursts	Minimum Percentage of Successful Detection	Minimum Number of Trials
5	50-100	5-20	1000-2000	1-3	8-20	80%	30

The parameters for this waveform are randomly chosen. Thirty unique waveforms are required for the Long Pulse Radar Type waveforms. If more than 30 waveforms are used for the Long Pulse Radar Type waveforms, then each additional waveform must also be unique and not repeated from the previous waveforms.

Table 7 – Frequency Hopping Radar Test Waveform

Radar Type	Pulse Width (μsec)	PRI (μsec)	Pulses per Hop	Hopping Rate (kHz)	Hopping Sequence Length (msec)	Minimum Percentage of Successful Detection	Minimum Number of Trials
6	1	333	9	0.333	300	70%	30

Table 5a - Pulse Repetition Intervals Values for Test A

Pulse Repetition Frequency Number	Pulse Repetition Frequency (Pulses Per Second)	Pulse Repetition Interval (Microseconds)
1	1930.5	518
2	1858.7	538
3	1792.1	558
4	1730.1	578
5	1672.2	598
6	1618.1	618
7	1567.4	638
8	1519.8	658
9	1474.9	678
10	1432.7	698
11	1392.8	718
12	1355	738
13	1319.3	758
14	1285.3	778
15	1253.1	798
16	1222.5	818
17	1193.3	838
18	1165.6	858
19	1139	878
20	1113.6	898
21	1089.3	918
22	1066.1	938
23	326.2	3066

Manufacturer’s Statement Regarding Uniform Channel Spreading

The end product implements an automatic channel selection feature at startup such that operation commences on channels distributed across the entire set of allowed 5GHz channels. This feature will ensure uniform spreading is achieved while avoiding non-allowed channels due to prior radar events.

TEST AND MEASUREMENT SYSTEM

System Overview

The measurement system is based on a conducted test method. The short pulse and long pulse signal generating system utilizes the NTIA software and the same manufacturer / model Vector Signal Generator as the NTIA. The hopping signal generating system utilizes the simulated hopping method. The software selects waveform parameters from within the bounds of the signal type on a random basis using uniform distribution. The short pulse types 2, 3 and 4, and the long pulse type 5 parameters are randomized at run-time. The hopping type 6 parameters are fixed while the hopping sequence is based on the August 2005 NTIA Hopping Frequency List, with the initial starting point randomized at run-time. The signal monitoring equipment consists of a spectrum analyzer with the capacity to display 8192 bins on the horizontal axis. A time-domain resolution of 2 msec / bin is achievable with a 16 second sweep time, meeting the 10 second short pulse reporting criteria. The aggregate ON time is calculated by multiplying the number of bins above a threshold during a particular observation period by the dwell time per bin, with the analyzer set to peak detection and max hold. A time-domain resolution of 3 msec / bin is achievable with a 24 second sweep

time, meeting the 22 second long pulse reporting criteria and allowing a minimum of 10 seconds after the end of the long pulse waveform.

Frequency Hopping Signal Generation

The hopping burst generator is a High Speed Digital I/O card plugged into the control computer. This card utilizes an independent hardware clock reference therefore the output pulse timing is unaffected by host computer operating system latency times.

The software selects the hopping sequence as a 100-length segment of the August 2005 NTIA hopping frequency list. This list contains 274 unique pseudorandom sequences. Each such sequence contains 475 frequencies ordered on a random without replacement basis. Each successive trial uses a contiguous 100-length segment from within each successive 475-length sequence in the list. The initial starting point within the list is randomized at run-time such that the first 100-length segment is entirely contained within the first 475-length sequence. The starting point of each successive trial is incremented by 475.

Each frequency in the 100-length segment is compared to the boundaries of the EUT Detection Bandwidth and the software creates a hopping burst pattern in accordance with Section 7.4.1.3 Method #2 Simulated Frequency Hopping Radar Waveform Generating Subsystem of FCC 06-96 APPENDIX. The frequency of the signal generator is incremented in 1 MHz steps from FL to FH for each successive trial. This incremental sequence is repeated as required to generate a minimum of 30 total trials and to maintain a uniform frequency distribution over the entire Detection Bandwidth.

Conducted Method System Block Diagram

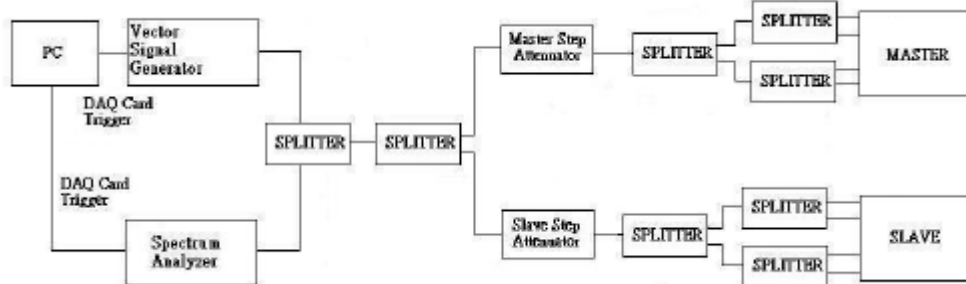

Measurement System Frequency Reference

Lock the signal generator and the spectrum analyzer to the same reference source as follows: Connect the 10 MHz OUT (SWITCHED) on the spectrum analyzer to the 10 MHz IN on the signal generator and set the spectrum analyzer 10 MHz Out to On.

System Calibration

Connect the spectrum analyzer to the test system in place of the master device. Set the signal generator to CW mode. Adjust the amplitude of the signal generator to yield a measured level of -62 dBm on the spectrum analyzer.

Without changing any of the instrument settings, reconnect the spectrum analyzer to the Common port of the Spectrum Analyzer Combiner/Divider and connect a 50 ohm load to the Master Device port of the test system. Measure the amplitude and calculate the difference from -62 dBm. Adjust the Reference Level Offset of the spectrum analyzer to this difference. Confirm that the signal is displayed at -62 dBm. Readjust the RBW and VBW to 3 MHz, set the span to 10 MHz, and confirm that the signal is still displayed at -62 dBm.

The spectrum analyzer displays the level of the signal generator as received at the antenna ports of the Master Device. The interference detection threshold may be varied from the calibrated value of -62 dBm and the spectrum analyzer will still indicate the level as received by the Master Device.

Set the signal generator to produce a radar waveform, trigger a burst manually and measure the level on the spectrum analyzer. Readjust the amplitude of the signal generator as required so that the peak level of the waveform is at a displayed level equal to the required or desired interference detection threshold. Separate signal generator amplitude settings are determined as required for each radar type.

Interference Detection Threshold Adjustment

Download the applicable radar waveforms to the signal generator. Select the radar waveform, trigger a burst manually and measure the amplitude on the spectrum analyzer. Readjust the amplitude of the signal generator as required so that the peak level of the waveform is at a displayed level equal to the required or desired interference detection threshold. Separate signal generator amplitude settings are determined as required for each radar type.

Adjustment Of Displayed Traffic Level

Establish a link between the Master and Slave, adjusting the Link Step Attenuator as needed to provide a suitable received level at the Master and Slave devices. Stream the video test file to generate WLAN traffic. Confirm that the WLAN traffic level, as displayed on the spectrum analyzer, is at lower amplitude than the radar detection threshold. Confirm that the displayed traffic is from the Master Device. For Master Device testing confirm that the displayed traffic does not include Slave Device traffic. For Slave Device testing confirm that the displayed traffic does not include Master Device traffic. If a different setting of the Master Step Attenuator is required to meet the above conditions, perform a new System Calibration for the new Master Step Attenuator setting.

Test Setup

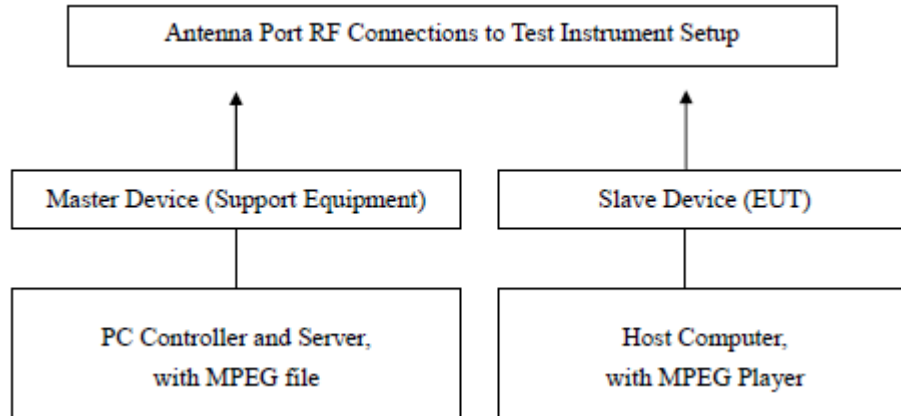

7. TEST RESULT

Radar Type 0

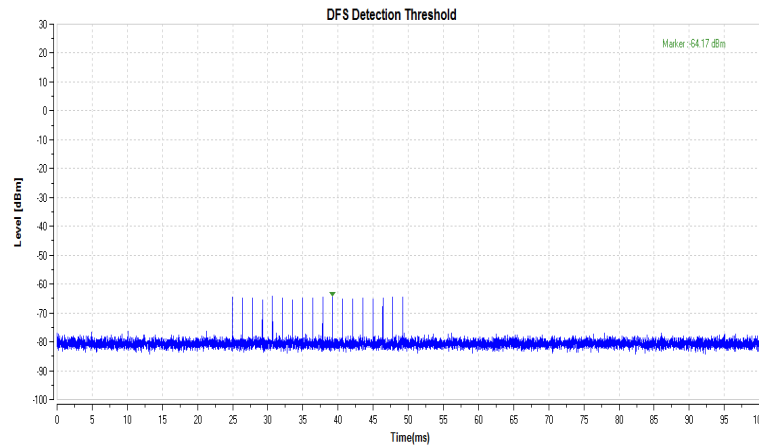

Trial List Table - FCC-13-22

Save Load Trigger Download All

Sample Rate: 10 MHz

	Trial Id	Radar Type	Pulse Width (us)	PRI (us)	Number of Pulses	Waveform Length (us)
Download	0	Type 0	1.0	1428.0	18	25704.0
Download	1	Type 0	1.0	1428.0	18	25704.0
Download	2	Type 0	1.0	1428.0	18	25704.0
Download	3	Type 0	1.0	1428.0	18	25704.0
Download	4	Type 0	1.0	1428.0	18	25704.0
Download	5	Type 0	1.0	1428.0	18	25704.0
Download	6	Type 0	1.0	1428.0	18	25704.0
Download	7	Type 0	1.0	1428.0	18	25704.0
Download	8	Type 0	1.0	1428.0	18	25704.0
Download	9	Type 0	1.0	1428.0	18	25704.0
Download	10	Type 0	1.0	1428.0	18	25704.0
Download	11	Type 0	1.0	1428.0	18	25704.0
Download	12	Type 0	1.0	1428.0	18	25704.0
Download	13	Type 0	1.0	1428.0	18	25704.0
Download	14	Type 0	1.0	1428.0	18	25704.0
Download	15	Type 0	1.0	1428.0	18	25704.0
Download	16	Type 0	1.0	1428.0	18	25704.0
Download	17	Type 0	1.0	1428.0	18	25704.0
Download	18	Type 0	1.0	1428.0	18	25704.0
Download	19	Type 0	1.0	1428.0	18	25704.0
Download	20	Type 0	1.0	1428.0	18	25704.0
Download	21	Type 0	1.0	1428.0	18	25704.0
Download	22	Type 0	1.0	1428.0	18	25704.0
Download	23	Type 0	1.0	1428.0	18	25704.0
Download	24	Type 0	1.0	1428.0	18	25704.0
Download	25	Type 0	1.0	1428.0	18	25704.0
Download	26	Type 0	1.0	1428.0	18	25704.0
Download	27	Type 0	1.0	1428.0	18	25704.0
Download	28	Type 0	1.0	1428.0	18	25704.0

Radar Type 2

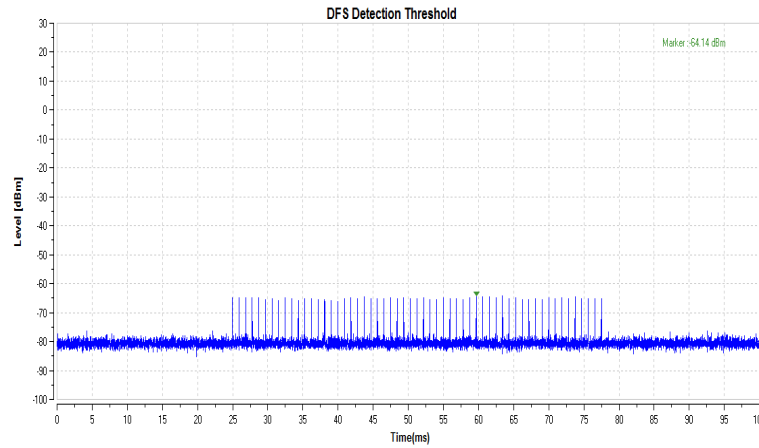

Trial List Table - FCC-13-22

Save Load Trigger Download All

Sample Rate 10 MHz

Trial List						
	Trial Id	Radar Type	Pulse Width (us)	PRI (us)	Number of Pulses	Waveform Length (us)
Download	0	Type 2	3.2	179.0	26	4654.0
Download	1	Type 2	1.1	207.0	23	4761.0
Download	2	Type 2	2.1	230.0	24	5520.0
Download	3	Type 2	4.6	200.0	29	5800.0
Download	4	Type 2	3.9	214.0	28	5992.0
Download	5	Type 2	2.9	222.0	26	5772.0
Download	6	Type 2	3.2	204.0	26	5304.0
Download	7	Type 2	2.5	192.0	25	4800.0
Download	8	Type 2	3.1	164.0	26	4264.0
Download	9	Type 2	1.2	156.0	23	3588.0
Download	10	Type 2	3.9	210.0	27	5670.0
Download	11	Type 2	4.6	201.0	29	5829.0
Download	12	Type 2	3.2	162.0	26	4212.0
Download	13	Type 2	2.2	197.0	25	4925.0
Download	14	Type 2	4.5	163.0	29	4727.0
Download	15	Type 2	3.0	203.0	26	5278.0
Download	16	Type 2	5.0	168.0	29	4872.0
Download	17	Type 2	2.4	217.0	25	5425.0
Download	18	Type 2	2.9	191.0	26	4966.0
Download	19	Type 2	2.3	166.0	25	4150.0
Download	20	Type 2	3.7	150.0	27	4050.0
Download	21	Type 2	2.2	176.0	25	4400.0
Download	22	Type 2	4.9	195.0	29	5655.0
Download	23	Type 2	2.9	202.0	26	5252.0
Download	24	Type 2	2.5	178.0	25	4450.0
Download	25	Type 2	1.1	206.0	23	4738.0
Download	26	Type 2	3.6	155.0	27	4185.0
Download	27	Type 2	4.7	157.0	29	4553.0
Download	28	Type 2	2.4	224.0	25	5600.0

Radar Type 3

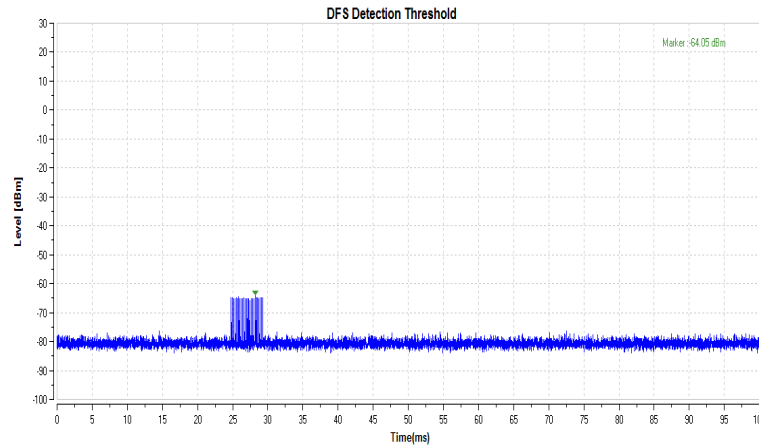

Trial List Table - FCC-13-22

Save Load Trigger Download All

Sample Rate 10 MHz

	Trial Id	Radar Type	Pulse Width (us)	PRI (us)	Number of Pulses	Waveform Length (us)
Download	0	Type 3	8.2	355.0	17	6035.0
Download	1	Type 3	6.1	487.0	16	7792.0
Download	2	Type 3	7.1	344.0	16	5504.0
Download	3	Type 3	9.8	288.0	18	5184.0
Download	4	Type 3	8.9	230.0	18	4140.0
Download	5	Type 3	7.9	432.0	17	7344.0
Download	6	Type 3	8.2	207.0	17	3519.0
Download	7	Type 3	7.5	443.0	17	7531.0
Download	8	Type 3	8.1	439.0	17	7463.0
Download	9	Type 3	6.2	223.0	16	3568.0
Download	10	Type 3	8.9	208.0	18	3744.0
Download	11	Type 3	9.6	463.0	18	8334.0
Download	12	Type 3	8.2	441.0	17	7497.0
Download	13	Type 3	7.2	323.0	16	5168.0
Download	14	Type 3	9.5	297.0	18	5346.0
Download	15	Type 3	8.0	412.0	17	7004.0
Download	16	Type 3	10.0	324.0	18	5832.0
Download	17	Type 3	7.4	271.0	17	4607.0
Download	18	Type 3	7.9	349.0	17	5933.0
Download	19	Type 3	7.3	409.0	16	6544.0
Download	20	Type 3	8.7	373.0	18	6714.0
Download	21	Type 3	7.2	254.0	16	4064.0
Download	22	Type 3	9.9	274.0	18	4932.0
Download	23	Type 3	7.9	278.0	17	4726.0
Download	24	Type 3	7.5	317.0	17	5389.0
Download	25	Type 3	6.1	260.0	16	4160.0
Download	26	Type 3	8.8	211.0	18	3798.0
Download	27	Type 3	9.7	272.0	18	4896.0
Download	28	Type 3	7.4	264.0	17	4488.0

Radar Type 4

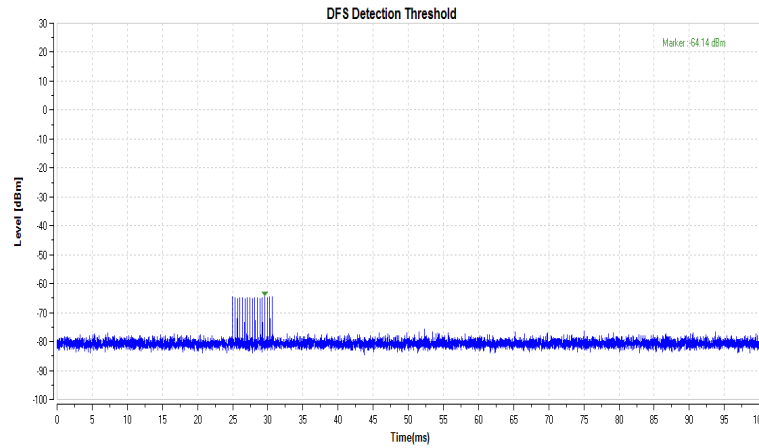

Trial List Table - FCC-13-22

Save Load Trigger Download All

Sample Rate 10 MHz

	Trial Id	Radar Type	Pulse Width (us)	PRI (us)	Number of Pulses	Waveform Length (us)
Download	0	Type 4	16.0	355.0	14	4970.0
Download	1	Type 4	11.3	487.0	12	5844.0
Download	2	Type 4	13.5	344.0	13	4472.0
Download	3	Type 4	19.4	288.0	16	4608.0
Download	4	Type 4	17.5	230.0	15	3450.0
Download	5	Type 4	15.3	432.0	14	6048.0
Download	6	Type 4	15.9	207.0	14	2898.0
Download	7	Type 4	14.3	443.0	13	5759.0
Download	8	Type 4	15.8	439.0	14	6146.0
Download	9	Type 4	11.5	223.0	12	2676.0
Download	10	Type 4	17.4	208.0	15	3120.0
Download	11	Type 4	19.0	463.0	16	7408.0
Download	12	Type 4	16.0	441.0	14	6174.0
Download	13	Type 4	13.8	323.0	13	4199.0
Download	14	Type 4	18.9	297.0	16	4752.0
Download	15	Type 4	15.5	412.0	14	5768.0
Download	16	Type 4	19.9	324.0	16	5184.0
Download	17	Type 4	14.1	271.0	13	3523.0
Download	18	Type 4	15.2	349.0	14	4866.0
Download	19	Type 4	13.8	409.0	13	5317.0
Download	20	Type 4	17.1	373.0	15	5595.0
Download	21	Type 4	13.8	254.0	13	3302.0
Download	22	Type 4	19.8	274.0	16	4364.0
Download	23	Type 4	15.3	278.0	14	3892.0
Download	24	Type 4	14.5	317.0	13	4121.0
Download	25	Type 4	11.3	260.0	12	3120.0
Download	26	Type 4	17.3	211.0	15	3165.0
Download	27	Type 4	19.2	272.0	16	4352.0
Download	28	Type 4	14.2	264.0	13	3432.0

Radar Type 5

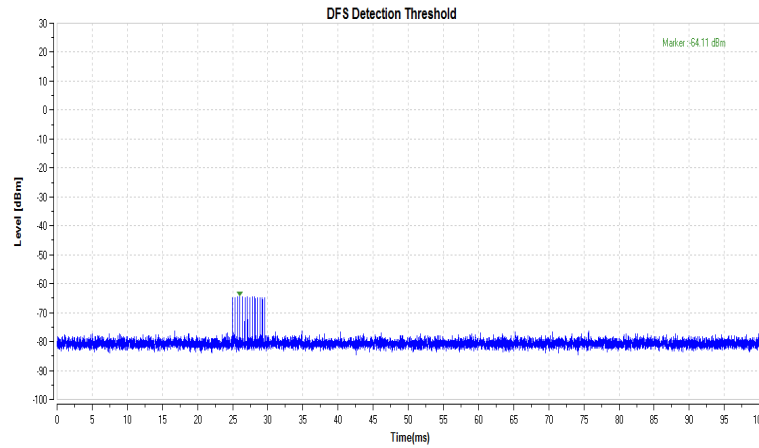

Trial List Table - FCC-13-22

Save Load Trigger Download All

Sample Rate: 100 MHz UUT Channel Center Frequency: 5.5 GHz Radar Detection Bandwidth: 5 MHz

Trial List									
		Trial Id	Radar Type	Number of Bursts	Burst Period (s)	Waveform Length (s)	Center Frequency (GHz)		
Download	0	Type 5	15	0.8000000	12.0000000	5.500000000			
Download	1	Type 5	8	1.5000000	12.0000000	5.500000000			
Download	2	Type 5	11	1.0909091	12.0000000	5.500000000			
Download	3	Type 5	20	0.6000000	12.0000000	5.500000000			
Download	4	Type 5	17	0.7058824	12.0000000	5.500000000			
Download	5	Type 5	14	0.8571429	12.0000000	5.500000000			
Download	6	Type 5	15	0.8000000	12.0000000	5.500000000			
Download	7	Type 5	12	1.0000000	12.0000000	5.500000000			
Download	8	Type 5	14	0.8571429	12.0000000	5.500000000			
Download	9	Type 5	8	1.5000000	12.0000000	5.500000000			
Download	10	Type 5	17	0.7058824	12.0000000	5.503900000			
Download	11	Type 5	19	0.6315789	12.0000000	5.505100000			
Download	12	Type 5	15	0.8000000	12.0000000	5.502700000			
Download	13	Type 5	12	1.0000000	12.0000000	5.501500000			
Download	14	Type 5	19	0.6315789	12.0000000	5.504700000			
Download	15	Type 5	14	0.8571429	12.0000000	5.502300000			
Download	16	Type 5	20	0.6000000	12.0000000	5.505500000			
Download	17	Type 5	12	1.0000000	12.0000000	5.501500000			
Download	18	Type 5	14	0.8571429	12.0000000	5.502300000			
Download	19	Type 5	12	1.0000000	12.0000000	5.501500000			
Download	20	Type 5	16	0.7500000	12.0000000	5.498500000			
Download	21	Type 5	12	1.0000000	12.0000000	5.498900000			
Download	22	Type 5	20	0.6000000	12.0000000	5.494500000			
Download	23	Type 5	14	0.8571429	12.0000000	5.497700000			
Download	24	Type 5	13	0.9230769	12.0000000	5.498100000			
Download	25	Type 5	8	1.5000000	12.0000000	5.500500000			
Download	26	Type 5	17	0.7058824	12.0000000	5.496100000			
Download	27	Type 5	19	0.6315789	12.0000000	5.494900000			
Download	28	Type 5	12	1.0000000	12.0000000	5.498500000			

Radar Type 6

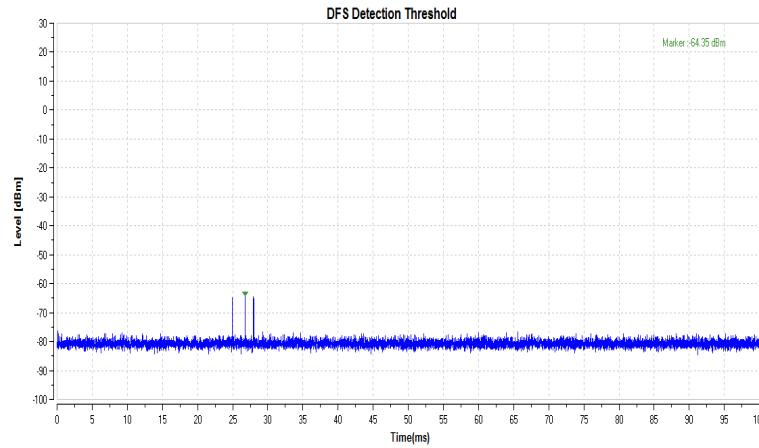

Trial List Table - FCC-13-22

Save Load Trigger Download All

Sample Rate: 200 MHz Center Frequency: 5500 MHz Channel Bandwidth: 160 MHz

Trial List									
		Trial Id	Radar Type	Pulse Width (us)	PRI (us)	Pulses per Hop	Hopping Rate (kHz)	Hopping Sequence Length (ms)	Visible Frequency Number
Download	0	Type 6	1.0	333.3	9	0.3333	300.0000000	32	
Download	1	Type 6	1.0	333.3	9	0.3333	300.0000000	27	
Download	2	Type 6	1.0	333.3	9	0.3333	300.0000000	25	
Download	3	Type 6	1.0	333.3	9	0.3333	300.0000000	33	
Download	4	Type 6	1.0	333.3	9	0.3333	300.0000000	37	
Download	5	Type 6	1.0	333.3	9	0.3333	300.0000000	30	
Download	6	Type 6	1.0	333.3	9	0.3333	300.0000000	33	
Download	7	Type 6	1.0	333.3	9	0.3333	300.0000000	27	
Download	8	Type 6	1.0	333.3	9	0.3333	300.0000000	33	
Download	9	Type 6	1.0	333.3	9	0.3333	300.0000000	30	
Download	10	Type 6	1.0	333.3	9	0.3333	300.0000000	37	
Download	11	Type 6	1.0	333.3	9	0.3333	300.0000000	36	
Download	12	Type 6	1.0	333.3	9	0.3333	300.0000000	38	
Download	13	Type 6	1.0	333.3	9	0.3333	300.0000000	35	
Download	14	Type 6	1.0	333.3	9	0.3333	300.0000000	28	
Download	15	Type 6	1.0	333.3	9	0.3333	300.0000000	37	
Download	16	Type 6	1.0	333.3	9	0.3333	300.0000000	35	
Download	17	Type 6	1.0	333.3	9	0.3333	300.0000000	37	
Download	18	Type 6	1.0	333.3	9	0.3333	300.0000000	27	
Download	19	Type 6	1.0	333.3	9	0.3333	300.0000000	34	
Download	20	Type 6	1.0	333.3	9	0.3333	300.0000000	35	
Download	21	Type 6	1.0	333.3	9	0.3333	300.0000000	37	
Download	22	Type 6	1.0	333.3	9	0.3333	300.0000000	41	
Download	23	Type 6	1.0	333.3	9	0.3333	300.0000000	36	
Download	24	Type 6	1.0	333.3	9	0.3333	300.0000000	29	
Download	25	Type 6	1.0	333.3	9	0.3333	300.0000000	32	
Download	26	Type 6	1.0	333.3	9	0.3333	300.0000000	30	
Download	27	Type 6	1.0	333.3	9	0.3333	300.0000000	31	

Channel Move Time & Channel Closing Transmission Time

IEEE 802.11ac VHT80
 Channel 58 / 5290 MHz

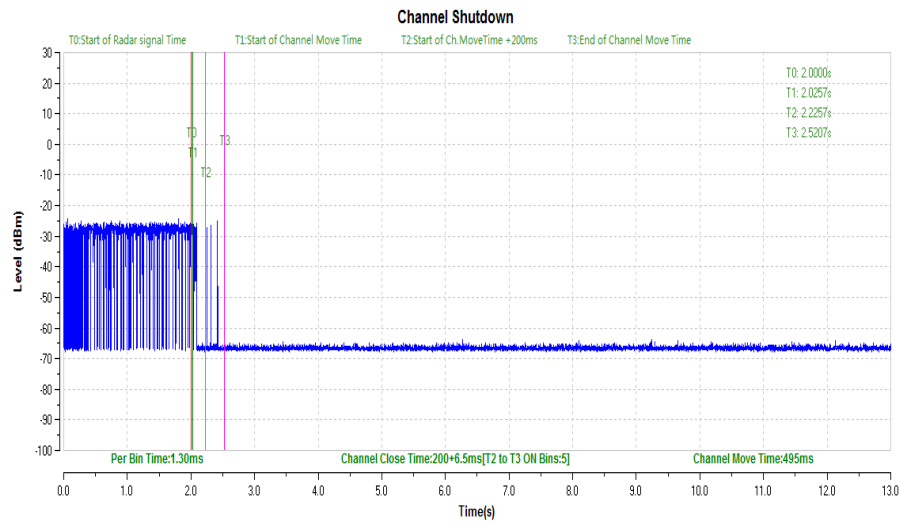

Channel Move Time (s)	Limit (s)
0.495	10

Channel Closing Transmission Time (ms)	Limit (ms)
200+6.5	200+60

IEEE 802.11ac VHT80
 Channel 106 / 5530 MHz

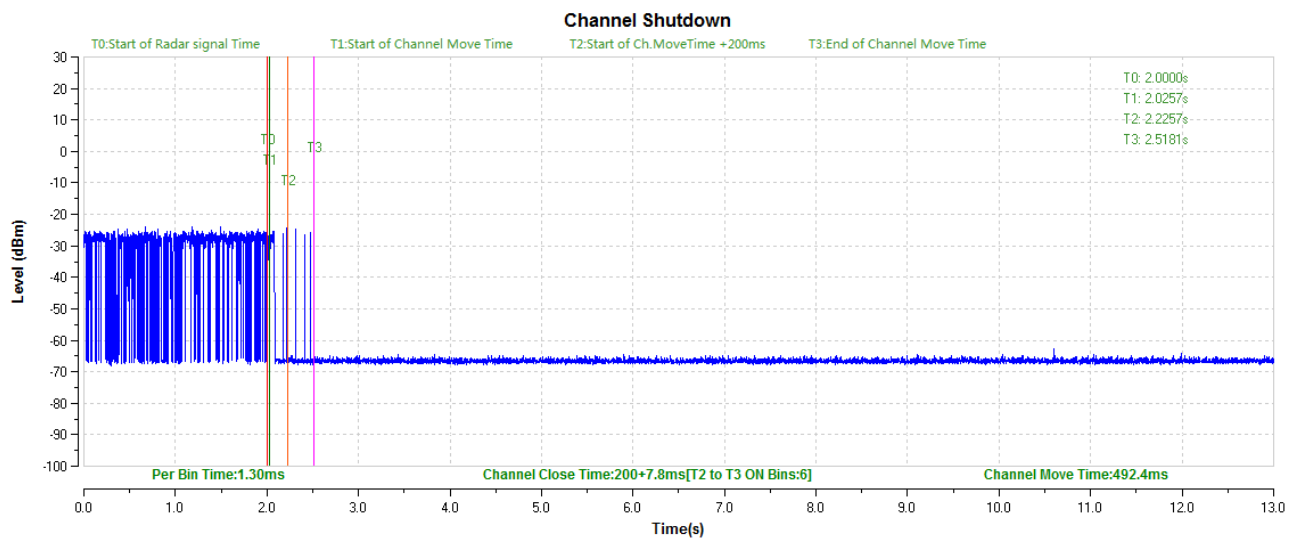

Channel Move Time (s)	Limit (s)
0.4924	10

Channel Closing Transmission Time (ms)	Limit (ms)
200+7.8	200+60

Remark: The time required for the master and slave devices to fully boot is 79 seconds.

Non-occupancy Period – Monitoring live time spectrum analyzer – Elapse time 30 minutes

IEEE 802.11ac VHT80

Channel 58 / 5290 MHz

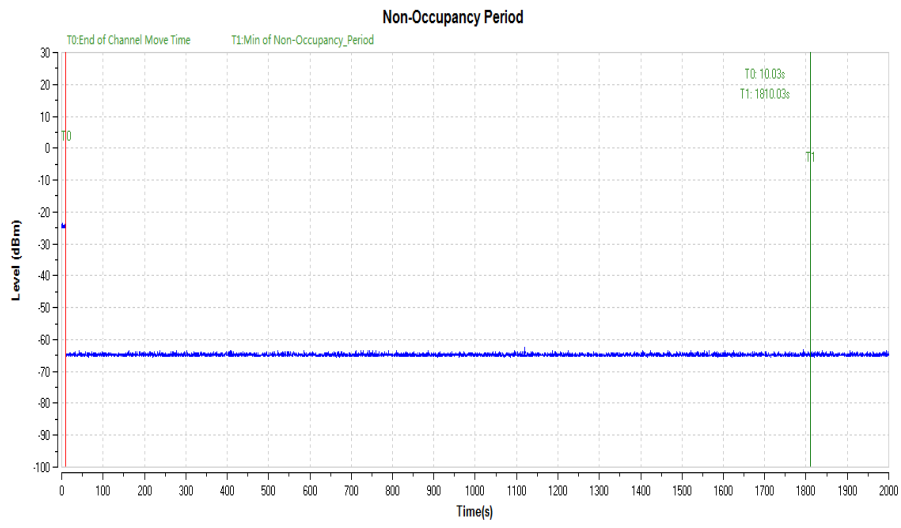

IEEE 802.11ac VHT80

Channel 106 / 5530 MHz

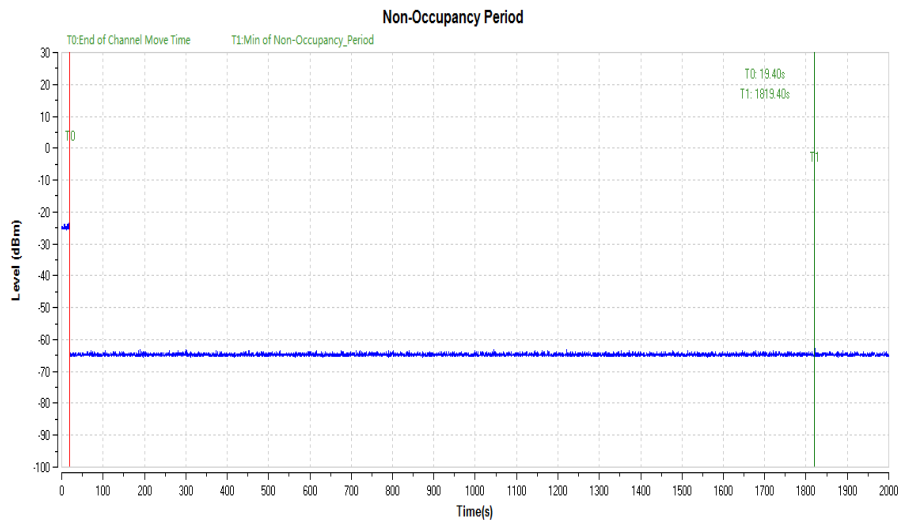

8. Test Setup Photos of the EUT

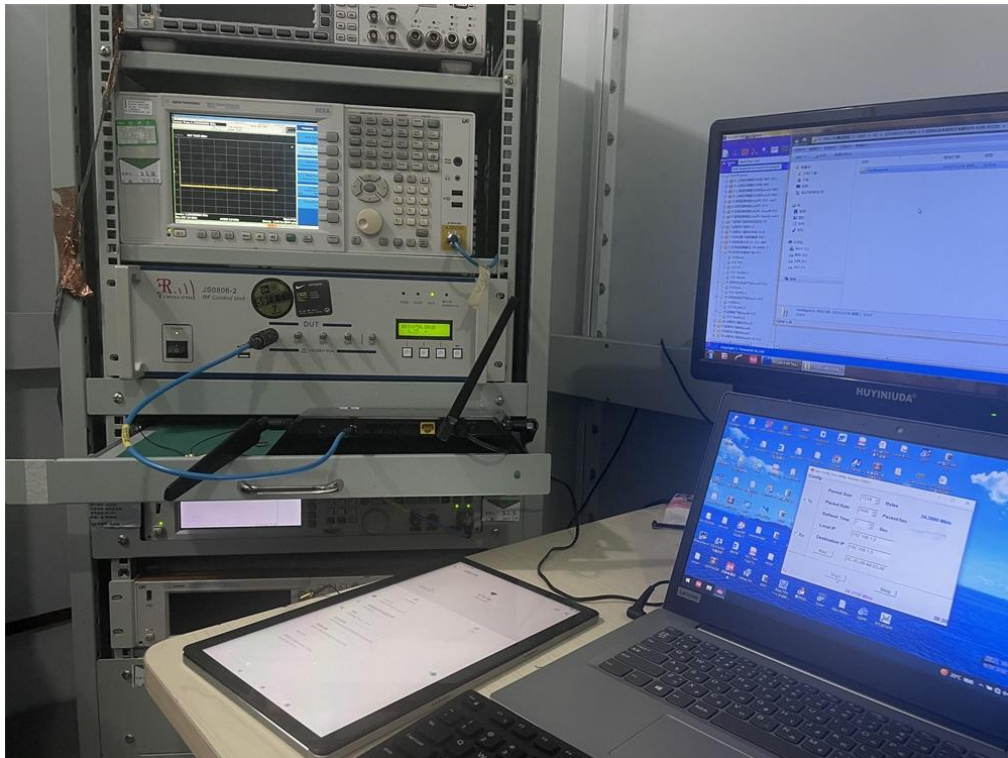

9. External and Internal Photos of the EUT

Reference to the test report No. GTS20221215006-1-1.

.....End of Report.....