

CUSTOMER NAME:	TUYA
PRODUCT NAME:	BT
Ren Feng P/N:	PCB Antenna

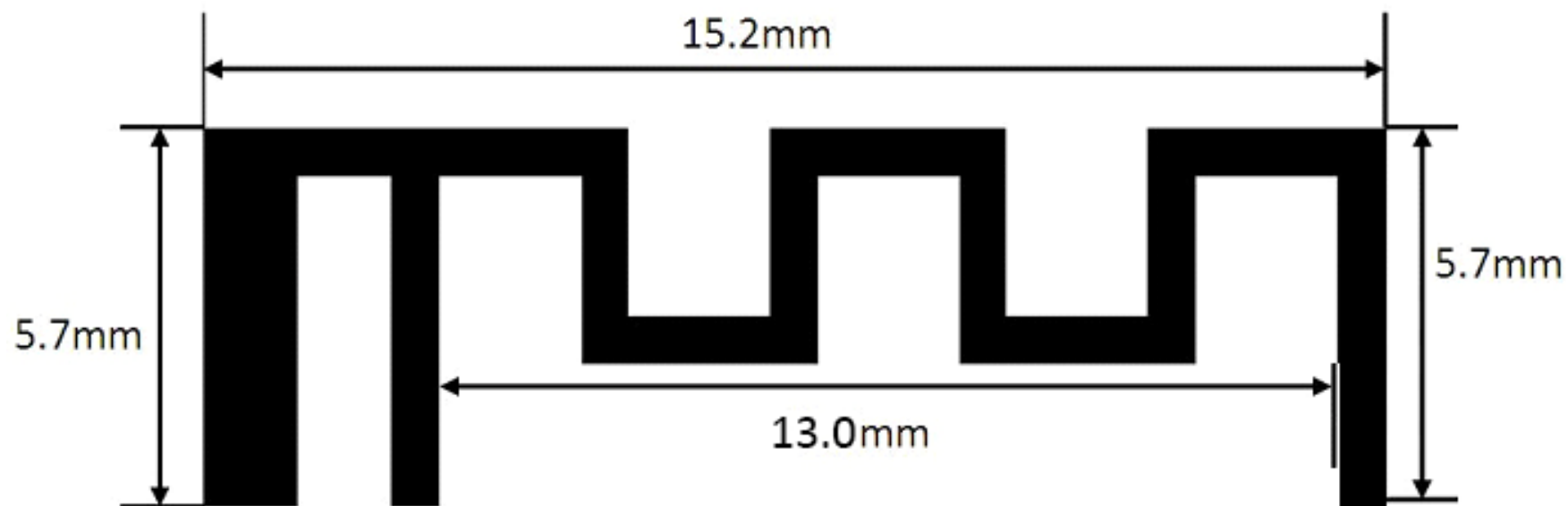

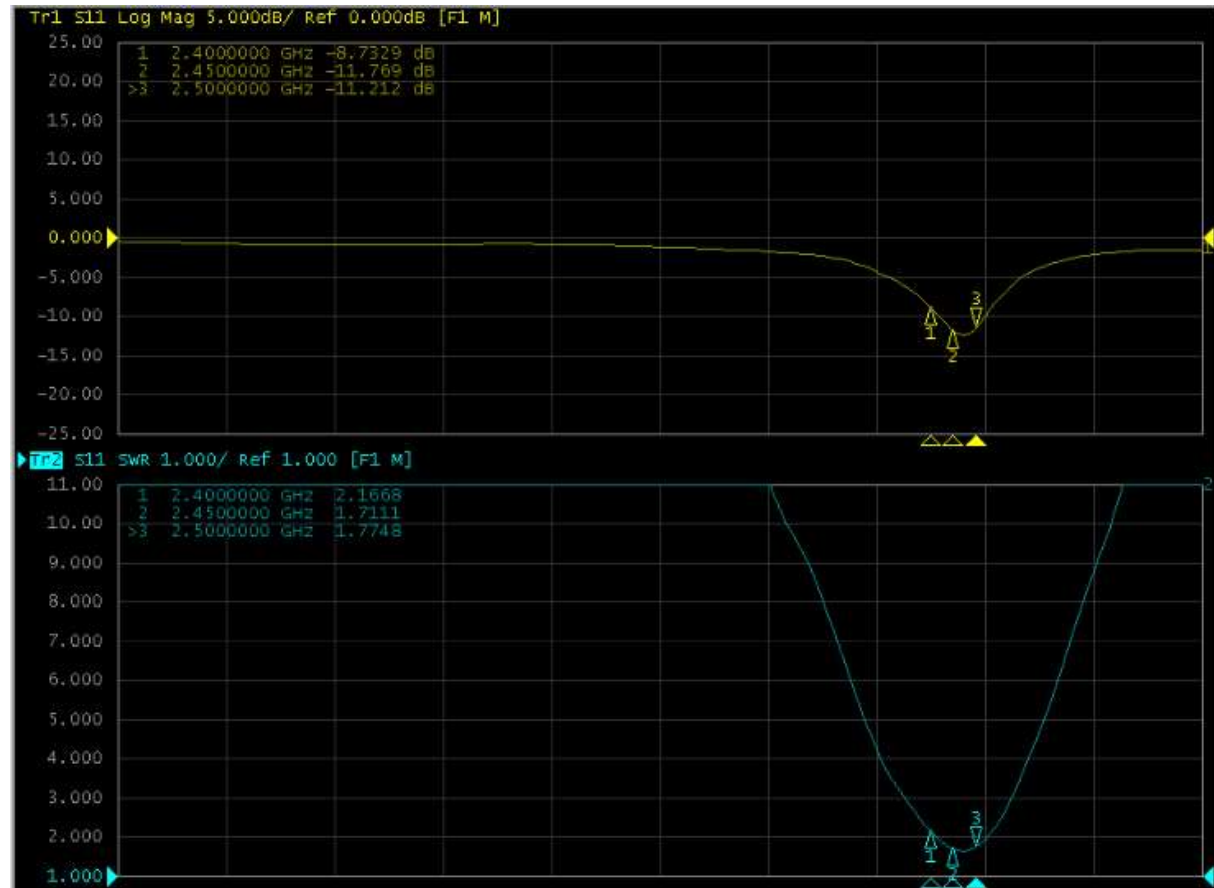

Frequency (MHz)	2400	2450	2500
Return Loss	-8.73	-11.76	-11.21
VSWR	2.16	1.71	1.77

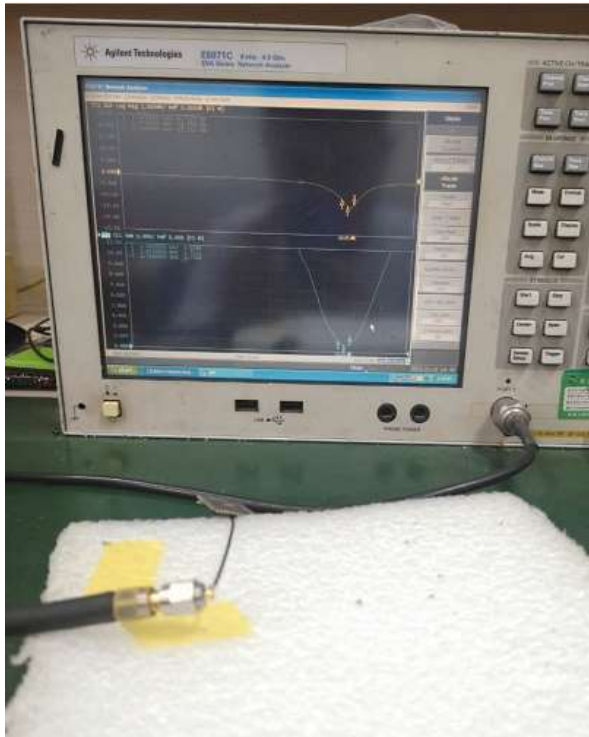
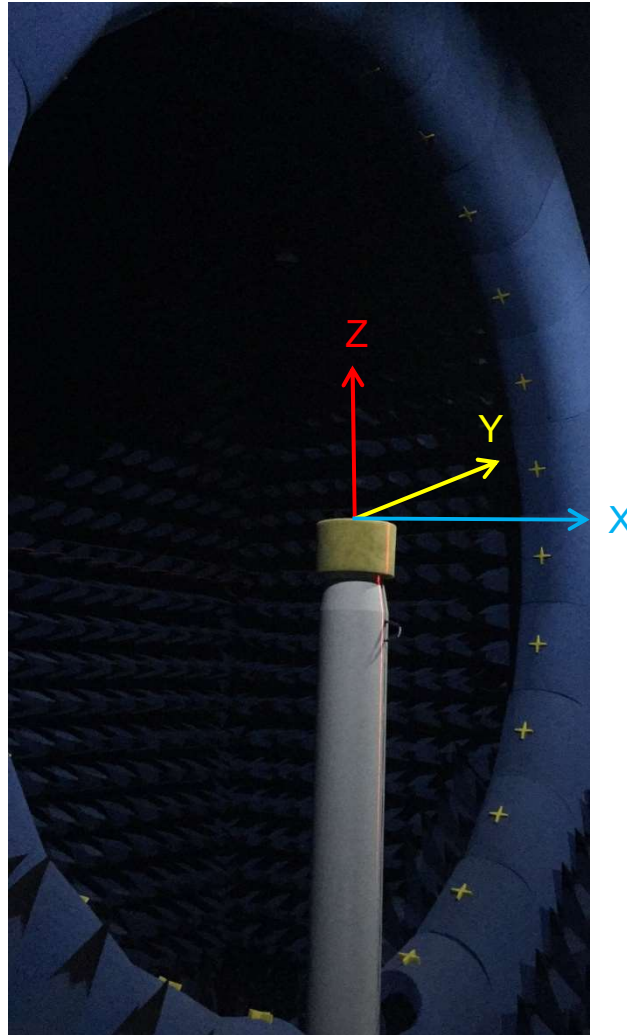

2D

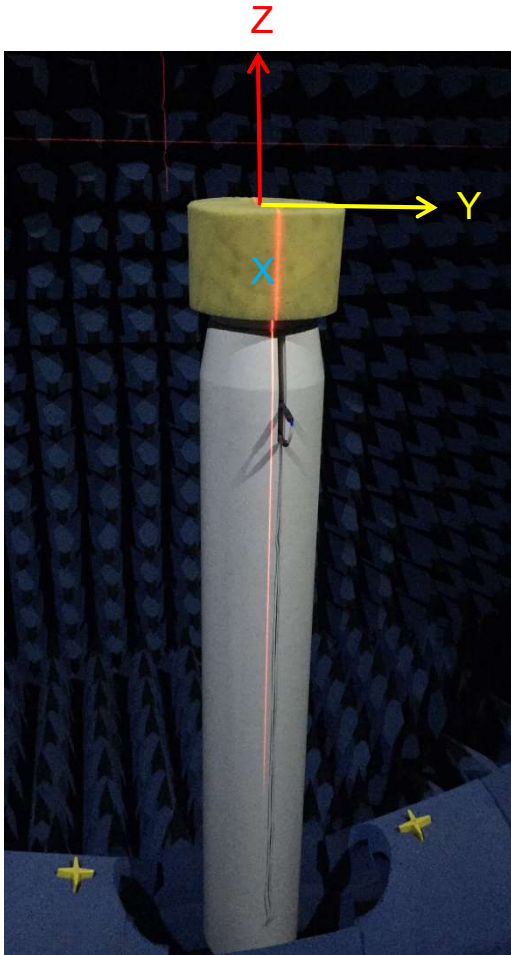

XY

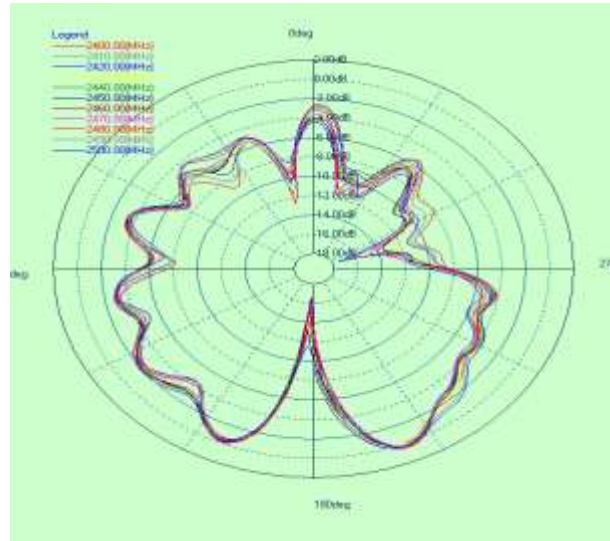

XZ

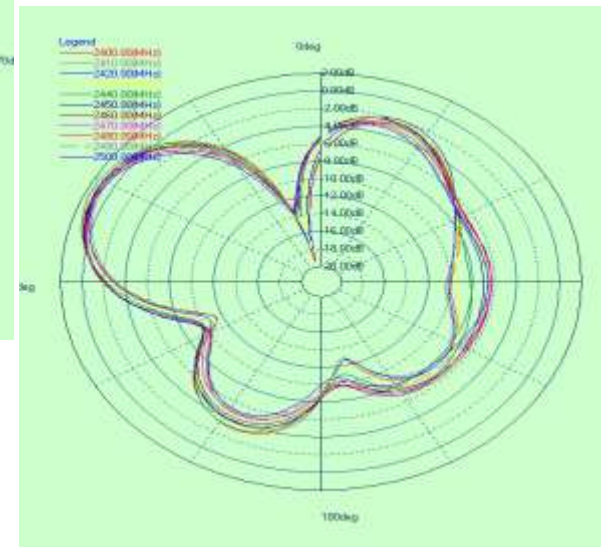

YZ

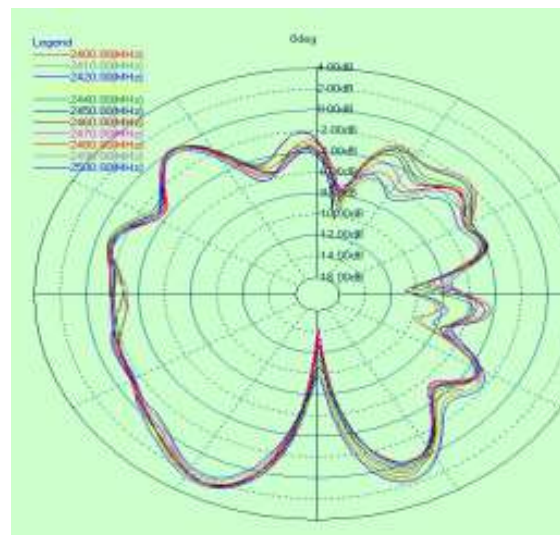

## 3D

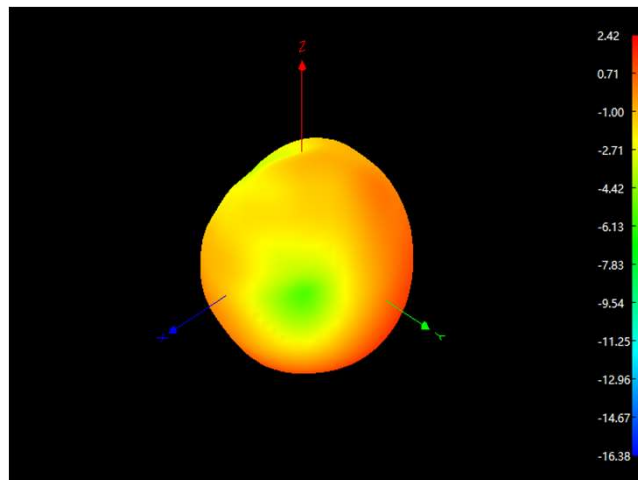
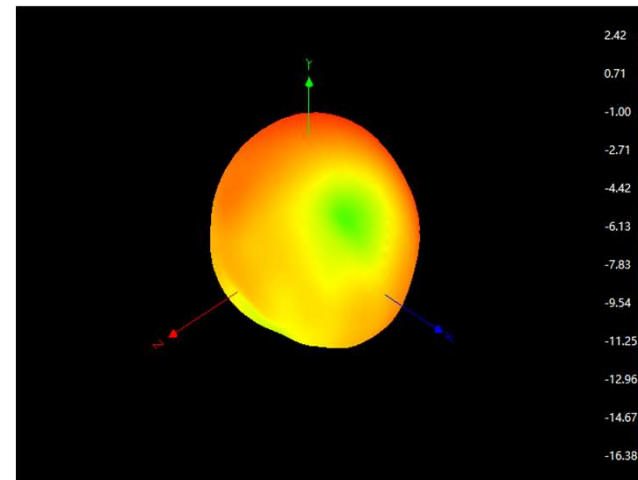
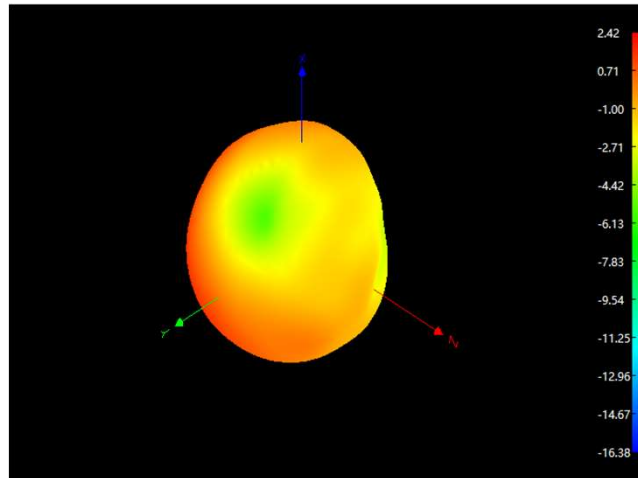

Freq. (MHz)	Effi (%)	Gain (dBi)
2400	52.29	1.62
2410	52.17	1.71
2420	53.14	1.93
2430	54.16	1.98
2440	57.62	2.00
2450	59.64	2.17
2460	61.55	2.45
2470	60.64	2.38
2480	62.86	2.54
2490	59.85	2.30
2500	60.41	2.49