



# FCC TEST REPORT

## FCC ID:2A684-S25

**Report Number**..... : ZKT-24090411093E

Date of Test..... Sep. 04, 2024 to Sep. 10, 2024

Date of issue..... Sep. 10, 2024

Total number of pages..... 22

Test Result ..... : PASS

**Testing Laboratory**..... : **Shenzhen ZKT Technology Co., Ltd.**

Address ..... : 1/F, No. 101, Building B, No. 6, Tangwei Community Industrial Avenue, Fuhai Street, Bao'an District, Shenzhen, China

**Applicant's name** ..... : **Shenzhen Yuyi Intelligent Electronics Co., Ltd.**

Address ..... : 401, Building B, Building 4, Yujianfeng Industrial Zone, No. 289  
Huafan Road, Tongsheng Community, Dalang Street, Longhua District, Shenzhen

**Manufacturer's name** ..... : **Shenzhen Yuyi Intelligent Electronics Co., Ltd.**

Address ..... : 401, Building B, Building 4, Yujianfeng Industrial Zone, No. 289  
Huafan Road, Tongsheng Community, Dalang Street, Longhua District, Shenzhen

**Test specification:**

Standard..... : FCC CFR Title 47 Part 15 Subpart C

Test procedure..... : /

Non-standard test method ..... : N/A

**Test Report Form No**..... : TRF-EL-107\_V0

**Test Report Form(s) Originator**..... : ZKT Testing

**Master TRF** ..... : Dated: 2020-01-06

This device described above has been tested by ZKT, and the test results show that the equipment under test (EUT) is in compliance with the FCC requirements. And it is applicable only to the tested sample identified in the report.

This report shall not be reproduced except in full, without the written approval of ZKT, this document may be altered or revised by ZKT, personal only, and shall be noted in the revision of the document.

**Product name**..... : **Magnetic car wireless charging**

Trademark ..... : **YUYI** 羽翼

Model/Type reference..... : S25  
SU3

Ratings..... : Input: 5V $\overline{\text{---}}$ 2A., 9V $\overline{\text{---}}$ 1.67A  
Output: 5W/7.5W/10W/15W



**Testing procedure and testing location:**

**Testing Laboratory**.....: **Shenzhen ZKT Technology Co., Ltd.**

**Address**.....: 1/F, No. 101, Building B, No. 6, Tangwei Community Industrial Avenue, Fuhai Street, Bao'an District, Shenzhen, China

**Tested by (name + signature)**.....: Jim Liu

**Reviewer (name + signature)**.....: Jackson Fang

**Approved (name + signature)**.....: Lake Xie





## TABLE OF CONTENTS

<b>1. VERSION</b> .....	<b>4</b>
<b>2. TEST SUMMARY</b> .....	<b>5</b>
2.1 TEST FACILITY .....	6
2.2 MEASUREMENT UNCERTAINTY .....	6
<b>3. GENERAL INFORMATION</b> .....	<b>7</b>
3.1 GENERAL DESCRIPTION OF EUT .....	7
3.2 Test mode .....	8
3.3 Block Diagram of EUT Configuration .....	9
3.4 Test Conditions .....	9
3.5 Description Of Support Units (Conducted Mode) .....	9
3.6 EQUIPMENTS LIST FOR ALL TEST ITEMS .....	10
<b>4. CONDUCTED EMISSION TEST</b> .....	<b>12</b>
4.1 CONDUCTED EMISSION MEASUREMENT .....	12
4.1.1 POWER LINE CONDUCTED EMISSION Limits .....	12
4.1.2 TEST PROCEDURE .....	12
4.1.3 DEVIATION FROM TEST STANDARD .....	12
4.1.4 TEST SETUP .....	13
4.1.5 EUT OPERATING CONDITIONS .....	13
4.1.6 Test Result .....	13
<b>5. RADIATED EMISSION MEASUREMENT</b> .....	<b>14</b>
5.1 Radiated Emission Limits .....	14
5.2 Anechoic Chamber Test Setup Diagram .....	15
5.3 Test Procedure .....	15
5.4 DEVIATION FROM TEST STANDARD .....	15
5.5 Test Result .....	16
<b>6. 20DB BANDWIDTH TEST</b> .....	<b>19</b>
<b>7. ANTENNA REQUIREMENT</b> .....	<b>21</b>
<b>8. TEST SETUP PHOTO</b> .....	<b>22</b>
<b>9. EUT CONSTRUCTIONAL DETAILS</b> .....	<b>22</b>



### 1. VERSION

Report No.	Version	Description	Approved
ZKT-24090411093E	Rev.01	Initial issue of report	Sep. 10, 2024



## 2. TEST SUMMARY

Test Item	Section in CFR 47	Result
Antenna requirement	15.203	Pass
AC Power Line Conducted Emission	15.207	N/A
Spurious Emission	15.209(a)(f)	Pass
20dB Bandwidth	15.215	Pass

NOTE:

(1) "N/A" denotes test is not applicable in this Test Report



## 2.1 TEST FACILITY

Shenzhen ZKT Technology Co., Ltd.  
Add. : 1/F, No. 101, Building B, No. 6, Tangwei Community Industrial Avenue, Fuhai Street, Bao'an District, Shenzhen, China

FCC Test Firm Registration Number: 692225  
Designation Number: CN1299  
IC Registered No.: 27033  
CAB identifier: CN0110

## 2.2 MEASUREMENT UNCERTAINTY

The reported uncertainty of measurement  $y \pm U$ , where expanded uncertainty  $U$  is based on a standard uncertainty multiplied by a coverage factor of  $k=2$ , providing a level of confidence of approximately 95 %.

No.	Item	Uncertainty
1	3m chamber Radiated spurious emission(9KHz-30MHz)	U=4.5dB
2	3m chamber Radiated spurious emission(30MHz-1GHz)	U=4.8dB
3	3m chamber Radiated spurious emission(1GHz-6GHz)	U=4.9dB
4	3m chamber Radiated spurious emission(6GHz-40GHz)	U=5.0dB
5	Conducted disturbance	U=3.2dB
6	RF conducted Spurious Emission	U=2.2dB
7	RF Occupied Bandwidth	U=1.8MHz
8	humidity uncertainty	U=5.3%
9	Temperature uncertainty	U=0.59°C



### 3. GENERAL INFORMATION

#### 3.1 GENERAL DESCRIPTION OF EUT

Product Name:	Magnetic car wireless charging
Model No.:	S25
Serial No.:	SU3
Model Difference:	Only the appearance of the color is different
Hardware version:	H 1.0
Software version:	V 1.1
Operation Frequency:	113kHz~205kHz
Modulation type:	ASK
Antenna Type:	Loop Coil Antenna
Antenna gain:	0dBi
Ratings:	Input: 5V $\overline{\text{---}}$ 2A., 9V $\overline{\text{---}}$ 1.67A Output: 5W/7.5W/10W/15W
Transmitting mode	Keep the EUT in continuously wireless charging mode



### 3.2 Test mode

To investigate the maximum EMI emission characteristics generated from EUT, the test system was pre-scanning tested based on the consideration of following EUT operation mode or test configuration mode which possibly have effect on EMI emission level. Each of these EUT operation mode(s) or test configuration mode(s) mentioned above was evaluated respectively.

#### a. EUT mode of operation before folding:

Test Modes:	Test Coil	Description:
Mode 1	ANT	AC/DC Adapter + EUT + Phone (Battery Status: <1%)
Mode 2		AC/DC Adapter + EUT + Phone (Battery Status: 50%)
Mode 3		AC/DC Adapter + EUT + Phone (Battery Status: >98%)





### 3.3 Block Diagram of EUT Configuration

Radiated Emission

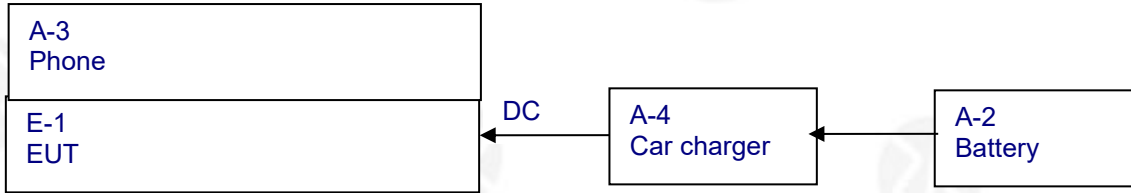

### 3.4 Test Conditions

Temperature: 23~26°C

Relative Humidity: 54~63 %

### 3.5 Description Of Support Units (Conducted Mode)

The EUT has been tested as an independent unit together with other necessary accessories or support units. The following support units or accessories were used to form a representative test configuration during the tests.

Item	Equipment	Mfr/Brand	Model/Type No.	Series No.	Note
E-1	Magnetic car wireless charging	N/A	S25	SU3	EUT
A-2	Storage Battery	Narada	ZKT-00	N/A	Auxiliary
A-3	Phone	Apple	iPhone 13	N/A	Auxiliary
A-4	Car charger	N/A	ZKT-05	N/A	Auxiliary

Item	Shielded Type	Ferrite Core	Length	Note
C1	NO	NO	0.8M	DC cable unshielded

Note:

- (1) The support equipment was authorized by Declaration of Confirmation.
- (2) For detachable type I/O cable should be specified the length in cm in 『Length』 column.
- (3) “YES” is means “shielded” “with core”; “NO” is means “unshielded” “without core”.



### 3.6 EQUIPMENTS LIST FOR ALL TEST ITEMS

#### Conduction Test equipment

Item	Kind of Equipment	Manufacturer	Type No.	Serial No.	Firmware Version	Last calibration	Calibrated until
1	LISN	R&S	ENV216	101471	N/A	Nov. 14, 2023	Nov. 13, 2024
2	LISN	CYBERTEK	EM5040A	E1850400149	N/A	Nov. 02, 2023	Nov. 01, 2024
3	Test Cable	N/A	C-01	N/A	N/A	Nov. 02, 2023	Nov. 01, 2024
4	Test Cable	N/A	C-02	N/A	N/A	Nov. 02, 2023	Nov. 01, 2024
5	Test Cable	N/A	C-03	N/A	N/A	Nov. 02, 2023	Nov. 01, 2024
6	EMI Test Receiver	R&S	ESCI3	101393	4.42 SP3	Nov. 02, 2023	Nov. 01, 2024
7	Triple-Loop Antenna	N/A	RF300	N/A	N/A	Nov. 02, 2023	Nov. 01, 2024
8	Absorbing Clamp	DZ	ZN23201	15034	N/A	Nov. 07, 2023	Nov. 06, 2024
9	EMC Software	Frad	EZ-EMC	Ver.EMC-CON 3A1.1	N/A	\	\

#### Radiation Test equipment

Item	Equipment	Manufacturer	Type No.	Serial No.	Firmware Version	Last calibration	Calibrated until
1	Spectrum Analyzer (9kHz-26.5GHz)	KEYSIGHT	9020A	MY55370835	A.17.05	Nov. 02, 2023	Nov. 01, 2024
2	Spectrum Analyzer (10kHz-39.9GHz)	R&S	FSV40-N	100363	1.71 SP2	Nov. 02, 2023	Nov. 01, 2024
3	EMI Test Receiver (9kHz-7GHz)	R&S	ESCI7	101169	4.32	Nov. 02, 2023	Nov. 01, 2024
4	Bilog Antenna (30MHz-1500MHz)	Schwarzbeck	VULB9168	N/A	N/A	Nov. 13, 2023	Nov. 12, 2024
5	Horn Antenna (1GHz-18GHz)	Agilent	AH-118	071145	N/A	Nov. 13, 2023	Nov. 12, 2024
6	Horn Antenna (15GHz-40GHz)	A.H.System	SAS-574	588	N/A	Nov. 13, 2023	Nov. 12, 2024
7	Loop Antenna	TESEQ	HLA6121	58357	N/A	Nov. 16, 2023	Nov. 15, 2024
8	Amplifier (30-1000MHz)	EM Electronics	EM330 Amplifier	060747	N/A	Nov. 02, 2023	Nov. 01, 2024
9	Amplifier (1GHz-26.5GHz)	Agilent	8449B	3008A00315	N/A	Nov. 02, 2023	Nov. 01, 2024
10	Amplifier (500MHz-40GHz)	QuanJuDa	DLE-161	097	N/A	Nov. 02, 2023	Nov. 01, 2024
11	Test Cable	N/A	R-01	N/A	N/A	Nov. 02, 2023	Nov. 01, 2024
12	Test Cable	N/A	R-02	N/A	N/A	Nov. 02, 2023	Nov. 01, 2024
13	Test Cable	N/A	R-03	N/A	N/A	Nov. 02, 2023	Nov. 01, 2024
14	D.C. Power Supply	LongWei	TPR-6405D	N/A	N/A	\	\
15	EMC Software	Frad	EZ-EMC	Ver.EMC-CO N 3A1.1	N/A	\	\
16	Turntable	MF	MF-7802BS	N/A	N/A	\	\
17	Antenna tower	MF	MF-7802BS	N/A	N/A	\	\



RF Test equipment

Item	Equipment	Manufacturer	Type No.	Serial No.	Firmware Version	Last calibration	Calibrated until
1	Spectrum Analyzer (9kHz-26.5GHz)	KEYSIGHT	9020A	MY55370835	A.17.05	Nov. 02, 2023	Nov. 01, 2024
2	Spectrum Analyzer (10kHz-39.9GHz)	R&S	FSV40-N	100363	1.71 SP2	Nov. 02, 2023	Nov. 01, 2024
3	Test Cable	N/A	RF-01	N/A	N/A	Nov. 02, 2023	Nov. 01, 2024
4	Test Cable	N/A	RF-02	N/A	N/A	Nov. 02, 2023	Nov. 01, 2024
5	Test Cable	N/A	RF-03	N/A	N/A	Nov. 02, 2023	Nov. 01, 2024
6	ESG Signal Generator	Agilent	E4421B	N/A	B.03.84	Nov. 02, 2023	Nov. 01, 2024
7	Signal Generator	Agilent	N5182A	N/A	A.01.87	Nov. 02, 2023	Nov. 01, 2024
8	Magnetic Field Probe Tester	Narda	ELT-400	0-0344	N/A	Nov. 16, 2023	Nov. 15, 2024
9	Wideband Radio Communication Test	R&S	CMW500	106504	V 3.7.22	Nov. 02, 2023	Nov. 01, 2024
10	MWRF Power Meter Test system	MW	MW100-RF CB	N/A	N/A	Nov. 02, 2023	Nov. 01, 2024
11	D.C. Power Supply	LongWei	TPR-6405D	N/A	N/A	\	\
12	RF Software	MW	MTS8310	V2.0.0.0	N/A	\	\



#### 4. CONDUCTED EMISSION TEST

##### 4.1 CONDUCTED EMISSION MEASUREMENT

Test Requirement:	FCC Part15 C Section 15.207
Test Method:	ANSI C63.10:2013
Test Frequency Range:	150KHz to 30MHz
Receiver setup:	RBW=9KHz, VBW=30KHz, Sweep time=auto

##### 4.1.1 POWER LINE CONDUCTED EMISSION Limits

FREQUENCY (MHz)	Limit (dBuV)		Standard
	Quas-peak	Average	
0.15 -0.5	66 - 56 *	56 - 46 *	FCC
0.50 -5.0	56.00	46.00	FCC
5.0 -30.0	60.00	50.00	FCC

Note:

(1) \*Decreases with the logarithm of the frequency.

##### 4.1.2 TEST PROCEDURE

- a. The EUT was placed 0.8 meters from the horizontal ground plane with EUT being connected to the power mains through a line impedance stabilization network (LISN). All other support equipments powered from additional LISN(s). The LISN provide 50 Ohm/ 50uH of coupling impedance for the measuring instrument.
- b. Interconnecting cables that hang closer than 40 cm to the ground plane shall be folded back and forth in the center forming a bundle 30 to 40 cm long.
- c. I/O cables that are not connected to a peripheral shall be bundled in the center. The end of the cable may be terminated, if required, using the correct terminating impedance. The overall length shall not exceed 1 m.
- d. LISN at least 80 cm from nearest part of EUT chassis.
- e. For the actual test configuration, please refer to the related Item –EUT Test Photos.

##### 4.1.3 DEVIATION FROM TEST STANDARD

No deviation



#### 4.1.4 TEST SETUP

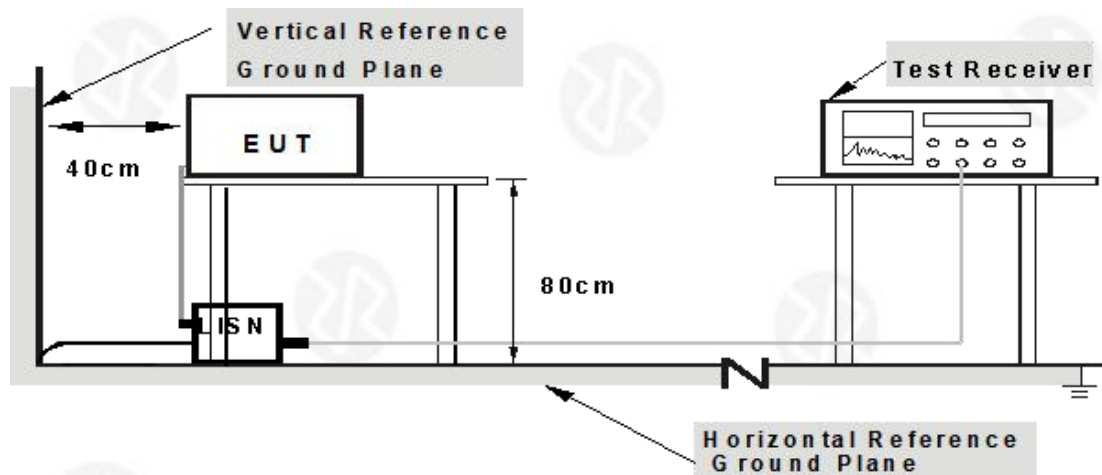

- Note:**
- 1.Support units were connected to second LISN.
  - 2.Both of LISNs (AMN) are 80 cm from EUT and at least 80 from other units and other metal planes

#### 4.1.5 EUT OPERATING CONDITIONS

The EUT was configured for testing in a typical fashion (as a customer would normally use it). The EUT has been programmed to continuously transmit during test. This operating condition was tested and used to collect the included data.

#### 4.1.6 Test Result

The EUT is powered by vehicle adapter DC and is not applicable only for test items.



## 5. RADIATED EMISSION MEASUREMENT

Test Requirement:	FCC Part15 C Section 15.209				
Test Method:	ANSI C63.10:2013				
Test Frequency Range:	9kHz to 1GHz				
Test site:	Measurement Distance: 3m				
Receiver setup:	Frequency	Detector	RBW	VBW	Value
	9KHz-150KHz	Quasi-peak	200Hz	600Hz	Quasi-peak
	150KHz-30MHz	Quasi-peak	9KHz	30KHz	Quasi-peak
	30MHz-1GHz	Quasi-peak	100KHz	300KHz	Quasi-peak
	Above 1GHz	Peak	1MHz	3MHz	Peak
		Peak	1MHz	10Hz	Average

### 5.1 Radiated Emission Limits

#### Limits for frequency below 30MHz

Frequency	Limit (uV/m)	Measurement Distance(m)	Remark
0.009-0.490	2400/F(kHz)	300	Quasi-peak Value
0.490-1.705	24000/F(kHz)	30	Quasi-peak Value
1.705-30	30	30	Quasi-peak Value

#### Limits for frequency Above 30MHz

Frequency	Limit (dBuV/m @3m)	Remark
30MHz-88MHz	40.00	Quasi-peak Value
88MHz-216MHz	43.50	Quasi-peak Value
216MHz-960MHz	46.00	Quasi-peak Value
960MHz-1GHz	54.00	Quasi-peak Value
Above 1GHz	54.00	Average Value
	74.00	Peak Value



## 5.2 Anechoic Chamber Test Setup Diagram

(A) Radiated Emission Test-Up Frequency Below 30MHz

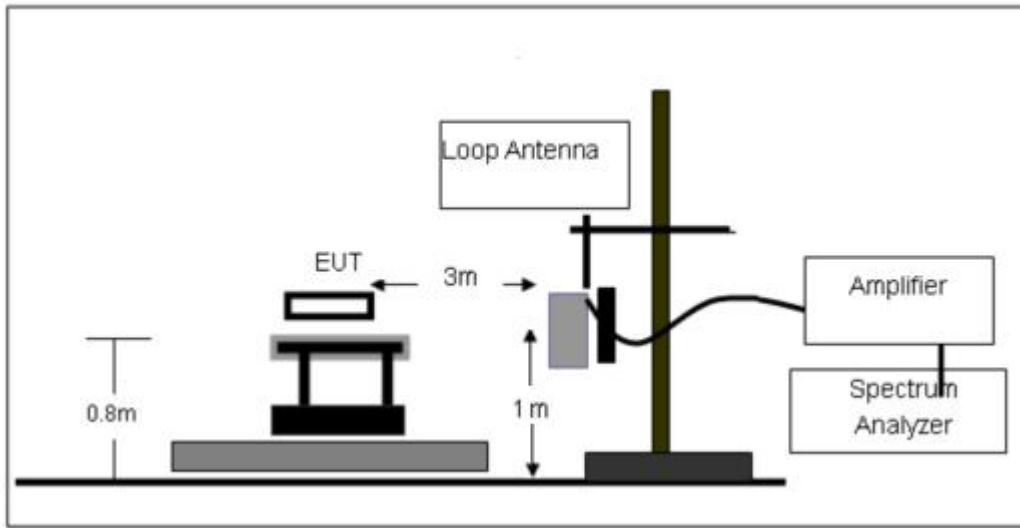

(B) Radiated Emission Test-Up Frequency 30MHz~1GHz

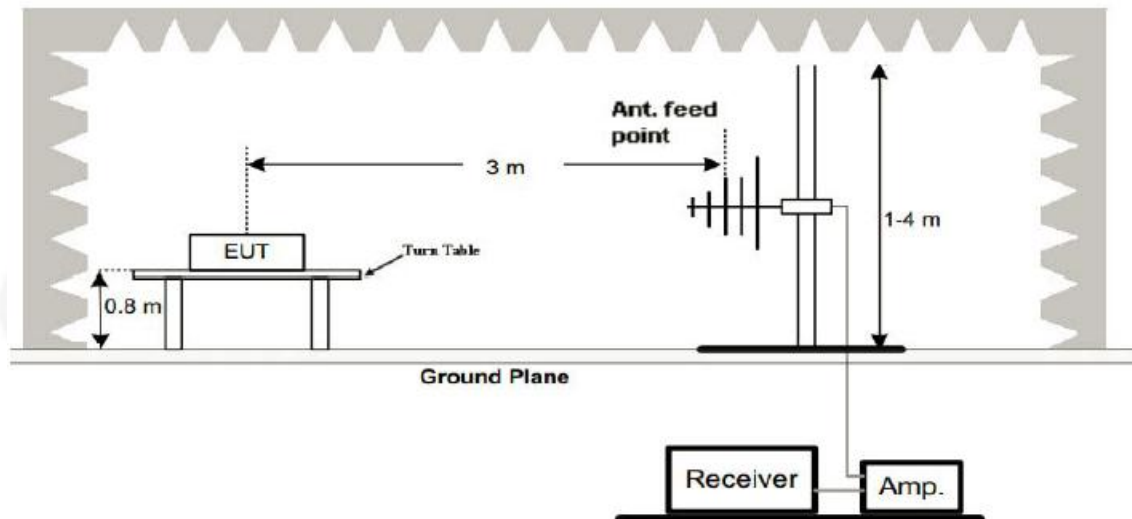

The radiated emission tests were performed in the 3 meters chamber test site, using the setup accordance with the ANSI C63.10-2013. The specification used was the FCC 15.209 and FCC 15.205 limits.

## 5.3 Test Procedure

The EUT is placed on a turn table which is 0.8 meter above ground. The turn table can rotate 360 degrees to determine the position of the maximum emission level. The EUT is set 3 meters away from the receiving antenna which is mounted on a antenna tower. The antenna can move up and down between 1 to 4 meters to find out the maximum emission level. Broadband antenna (calibrated by dipole antenna) are used as a receiving antenna. Both horizontal and vertical polarization of the antenna are set on measurement.

## 5.4 DEVIATION FROM TEST STANDARD

No deviation





5.5 Test Result

Measurement data:

Note: Limit dBuV/m @3m = Limit dBuV/m @300m+ 80  
Limit dBuV/m @3m = Limit dBuV/m @30m + 40

9 kHz~30 MHz

Temperature:	26°C	Relative Humidity:	54%
Pressure:	101 kPa	Polarization:	coaxial
Test Voltage:	DC 9V	Test Mode:	Mode 1

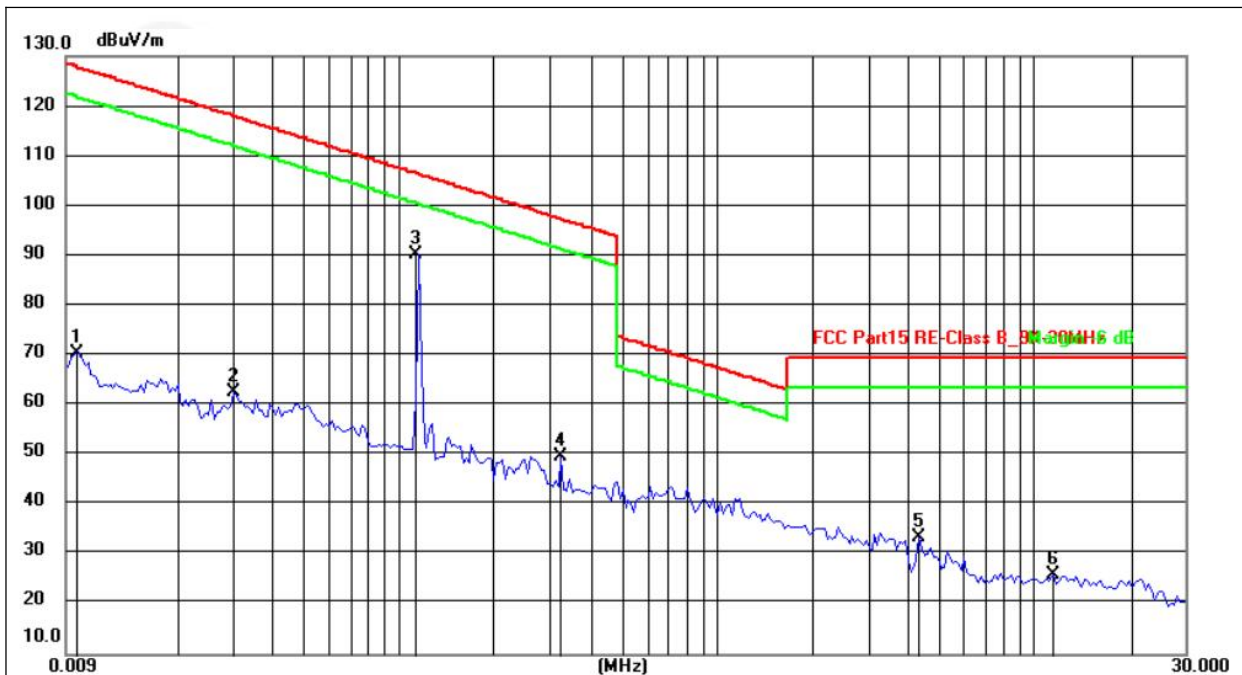

No.	Frequency (MHz)	Reading (dBuV)	Factor (dB/m)	Level (dBuV/m)	Limit (dBuV/m)	Margin (dB)	Detector
1	0.0097	70.45	0.05	70.50	127.87	-57.37	peak
2	0.0303	42.31	20.21	62.52	117.98	-55.46	peak
3	0.1132	70.27	19.84	90.11	106.53	-16.42	peak
4	0.3259	29.62	20.13	49.75	97.34	-47.59	peak
5	4.3695	13.97	19.52	33.49	69.54	-36.05	peak
6	11.5655	7.06	18.98	26.04	69.54	-43.50	peak

Remarks:

- 1.An initial pre-scan was performed on the peak detector.
- 2.Quasi-Peak measurement were performed at the frequencies with maximized peak emission.
- 3.The emission levels of other frequencies are very lower than the limit and not show in test report.
- 4.Final Level = Reading level + Correct Factor
- 5.Correct Factor= Antenna factor+ Cable loss factor - Amplifier factor
- 6.Margin= Measurement Level-Limit





30MHz-1GHz

Temperature:	26°C	Relative Humidity:	54%
Pressure:	101 kPa	Polarization:	Horizontal
Test Voltage:	DC 9V	Test Mode:	Mode 1

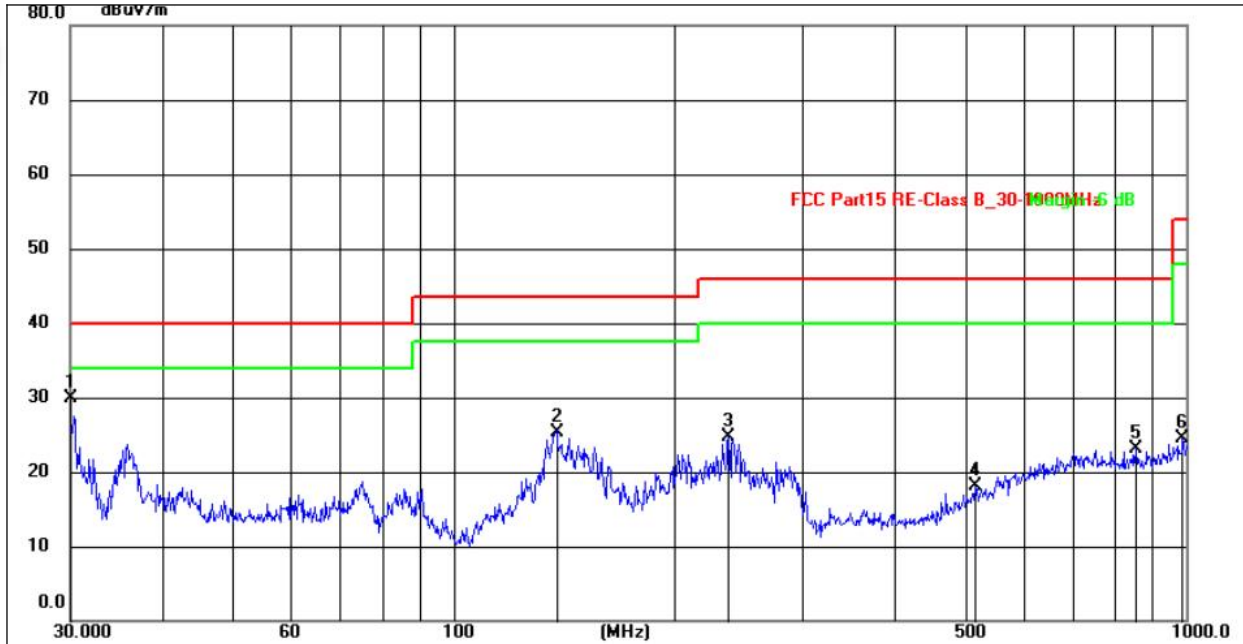

No.	Frequency (MHz)	Reading (dBUV)	Factor (dB/m)	Level (dBUV/m)	Limit (dBUV/m)	Margin (dB)	Detector
1	30.0000	44.02	-14.21	29.81	40.00	-10.19	QP
2	138.3873	42.46	-17.06	25.40	43.50	-18.10	QP
3	237.4757	41.10	-16.46	24.64	46.00	-21.36	QP
4	515.4373	29.23	-11.18	18.05	46.00	-27.95	QP
5	854.0247	30.15	-6.97	23.18	46.00	-22.82	QP
6	989.5353	29.61	-5.09	24.52	54.00	-29.48	QP

Remarks:

- 1.An initial pre-scan was performed on the peak detector.
- 2.Quasi-Peak measurement were performed at the frequencies with maximized peak emission.
- 3.The emission levels of other frequencies are very lower than the limit and not show in test report.
- 4.Final Level = Reading level + Correct Factor
- 5.Correct Factor= Antenna factor+ Cable loss factor - Amplifier factor
- 6.Margin= Measurement Level-Limit
- 7.All test modes were tested, with only the worst Mode 1 recorded.



Temperature:	26°C	Relative Humidity:	54%
Pressure:	101kPa	Polarization:	Vertical
Test Voltage:	DC 9V	Test Mode:	Mode 1

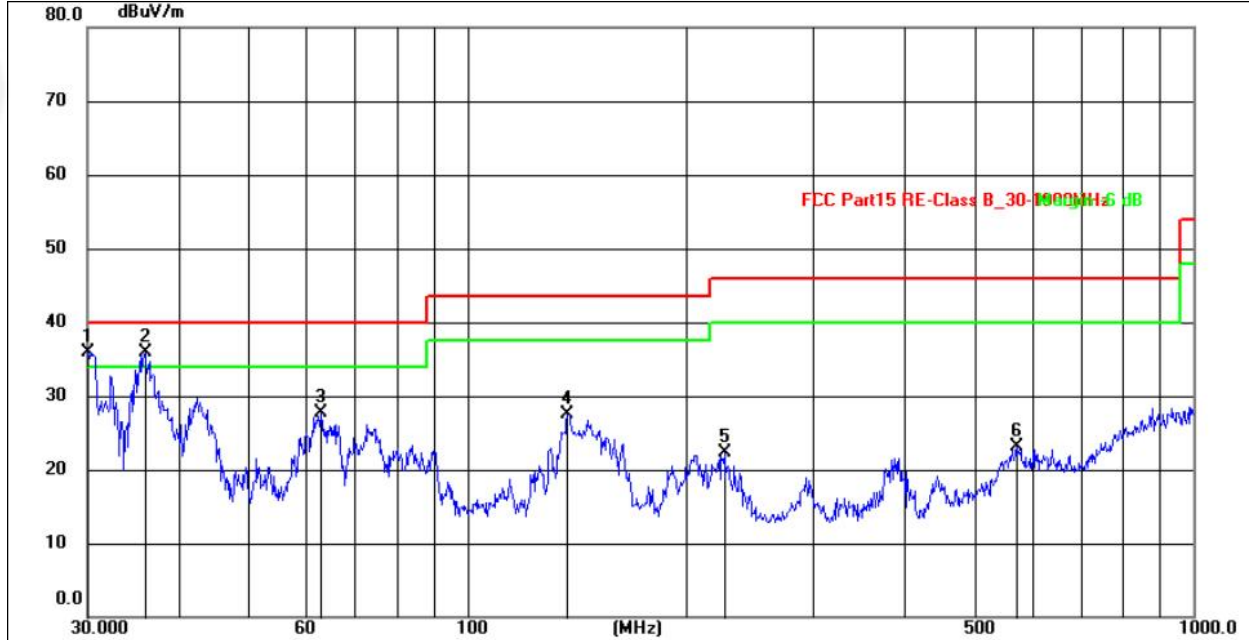

No.	Frequency (MHz)	Reading (dBuV)	Factor (dB/m)	Level (dBuV/m)	Limit (dBuV/m)	Margin (dB)	Detector
1	30.0000	54.32	-18.44	35.88	40.00	-4.12	QP
2	36.0007	53.45	-17.45	36.00	40.00	-4.00	QP
3	62.8706	46.22	-18.61	27.61	40.00	-12.39	QP
4	137.4201	48.59	-20.99	27.60	43.50	-15.90	QP
5	226.0994	42.66	-20.35	22.31	46.00	-23.69	QP
6	570.6100	32.07	-8.88	23.19	46.00	-22.81	QP

Remarks:

1. An initial pre-scan was performed on the peak detector.
2. Quasi-Peak measurement were performed at the frequencies with maximized peak emission.
3. The emission levels of other frequencies are very lower than the limit and not show in test report.
4. Final Level = Reading level + Correct Factor
5. Correct Factor = Antenna factor + Cable loss factor - Amplifier factor
6. Margin = Measurement Level - Limit
7. All test modes were tested, with only the worst Mode 1 recorded.



## 6. 20DB BANDWIDTH TEST

1. Se span = 1.5 ~ 5 times OBW.
2. Set RBW = 300Hz.
3. Set the video bandwidth (VBW)  $\geq 3 \times$  RBW.
4. Detector = peak.
5. Trace mode = max hold.
6. Sweep = auto couple.
7. Allow the trace to stabilize.
8. Measure the maximum width of the emission that is constrained by the frequencies associated with the two outermost amplitude points (upper and lower frequencies) that are attenuated by 20 dB relative to the maximum level measured in the fundamental emission.

### TEST SETUP





Temperature:	26 °C	Relative Humidity:	54%
Pressure:	101kPa	Test Voltage:	DC 9V

Test Coil	Frequency (kHz)	20dB Bandwidth (kHz)	Result
ANT 1	113.15	3.492	Pass





## 7. ANTENNA REQUIREMENT

Standard requirement:	FCC Part15 C Section 15.203
15.203 requirement: An intentional radiator shall be designed to ensure that no antenna other than that furnished by the responsible party shall be used with the device. The use of a permanently attached antenna or of an antenna that uses a unique coupling to the intentional radiator, the manufacturer may design the unit so that a broken antenna can be replaced by the user, but the use of a standard antenna jack or electrical connector is prohibited.	
EUT Antenna:	
The antenna is Loop Coil antenna, the best case gain of the antennas is 0dBi, reference to the appendix II for details	



## 8. TEST SETUP PHOTO

Reference to the appendix I for details.

## 9. EUT CONSTRUCTIONAL DETAILS

Reference to the appendix II for details.

\*\*\*\*\* END OF REPORT \*\*\*\*\*