



**CFR 47 FCC PART 15 SUBPART C**

**CERTIFICATION TEST REPORT**

*For*

**PRECISION ANCHOR/PRECISION TAG**

**MODEL: S001CE0300001, DMI-WP-TAG-001, DMTGWPWMBTXX,  
DMANWPWMBTXX**

**FCC ID: 2A66N-PIGEON**

**REPORT NUMBER: 4790420108-3**

**ISSUE DATE: June 15, 2022**

*Prepared for*

**TEN PAO PRECISION ELECTRONICS COMPANY LIMITED  
RM 610-611 6/F KWONG SANG HONG CENTRE 151-153 HOI BUN RD KWUN  
TONG KL HONGKONG CHINA**

*Prepared by*

**UL Verification Services (Guangzhou) Co., Ltd, Song Shan Lake Branch**

**Building 10, Innovation Technology Park, No. 1, Li Bin Road, Song Shan Lake Hi-Tech Development Zone Dongguan, 523808, People's Republic of China**

**Tel: +86 769 22038881**

**Fax: +86 769 33244054**

**Website: [www.ul.com](http://www.ul.com)**



Revision History

<u>Rev.</u>	<u>Issue Date</u>	<u>Revisions</u>	<u>Revised By</u>
V0	06/15/2022	Initial Issue	



Summary of Test Results			
Clause	Test Items	FCC Rules	Test Results
1	6dB Bandwidth and 99% Occupied Bandwidth	FCC Part 15.247 (a) (2)	Pass
2	Peak Conducted Output Power	FCC Part 15.247 (b) (3)	Pass
3	Power Spectral Density	FCC Part 15.247 (e)	Pass
4	Conducted Bandedge and Spurious Emission	FCC Part 15.247 (d)	Pass
5	Radiated Bandedge and Spurious Emission	FCC Part 15.247 (d) FCC Part 15.209 FCC Part 15.205	Pass
6	Conducted Emission Test for AC Power Port	FCC Part 15.207	N/A
7	Antenna Requirement	FCC Part 15.203	Pass
<b>Note:</b> 1. This test report is only published to and used by the applicant, and it is not for evidence purpose in China. 2. The measurement result for the sample received is <Pass> according to < CFR 47 FCC PART 15 SUBPART C > when <Accuracy Method> decision rule is applied.			



## TABLE OF CONTENTS

<b>1. ATTESTATION OF TEST RESULTS .....</b>	<b>6</b>
<b>2. TEST METHODOLOGY .....</b>	<b>7</b>
<b>3. FACILITIES AND ACCREDITATION .....</b>	<b>7</b>
<b>4. CALIBRATION AND UNCERTAINTY .....</b>	<b>8</b>
4.1. <i>MEASURING INSTRUMENT CALIBRATION .....</i>	<i>8</i>
4.2. <i>MEASUREMENT UNCERTAINTY.....</i>	<i>8</i>
<b>5. EQUIPMENT UNDER TEST .....</b>	<b>9</b>
5.1. <i>DESCRIPTION OF EUT .....</i>	<i>9</i>
5.2. <i>CHANNEL LIST.....</i>	<i>9</i>
5.3. <i>MAXIMUM PEAK OUTPUT POWER.....</i>	<i>9</i>
5.4. <i>TEST CHANNEL CONFIGURATION.....</i>	<i>10</i>
5.5. <i>THE WORSE CASE POWER SETTING PARAMETER.....</i>	<i>10</i>
5.6. <i>DESCRIPTION OF AVAILABLE ANTENNAS .....</i>	<i>10</i>
5.7. <i>DESCRIPTION OF TEST SETUP.....</i>	<i>11</i>
<b>6. MEASURING INSTRUMENT AND SOFTWARE USED .....</b>	<b>12</b>
<b>7. ANTENNA PORT TEST RESULTS .....</b>	<b>14</b>
7.1. <i>ON TIME AND DUTY CYCLE.....</i>	<i>14</i>
7.2. <i>6 dB DTS BANDWIDTH AND 99 % OCCUPIED BANDWIDTH .....</i>	<i>15</i>
7.3. <i>CONDUCTED OUTPUT POWER.....</i>	<i>17</i>
7.4. <i>POWER SPECTRAL DENSITY.....</i>	<i>18</i>
7.5. <i>CONDUCTED BANDEDGE AND SPURIOUS EMISSIONS.....</i>	<i>20</i>
<b>8. RADIATED TEST RESULTS.....</b>	<b>22</b>
8.1. <i>RESTRICTED BANDEDGE.....</i>	<i>27</i>
8.1.1. <i>BLE_1M MODE .....</i>	<i>27</i>
8.2. <i>SPURIOUS EMISSIONS (1 GHz ~ 3 GHz).....</i>	<i>29</i>
8.2.1. <i>BLE_1M MODE .....</i>	<i>29</i>
8.3. <i>SPURIOUS EMISSIONS (3 GHz ~ 18 GHz).....</i>	<i>35</i>
8.3.1. <i>BLE_1M MODE .....</i>	<i>35</i>
8.4. <i>SPURIOUS EMISSIONS (18 GHz ~ 26 GHz).....</i>	<i>41</i>
8.4.1. <i>BLE_1M MODE .....</i>	<i>41</i>
8.5. <i>SPURIOUS EMISSIONS (30 MHz ~ 1 GHz).....</i>	<i>43</i>
8.5.1. <i>BLE_1M MODE .....</i>	<i>43</i>
8.6. <i>SPURIOUS EMISSIONS BELOW 30 MHz .....</i>	<i>45</i>
8.6.1. <i>BLE_1M MODE .....</i>	<i>45</i>



<b>9. ANTENNA REQUIREMENTS</b> .....	<b>48</b>
<b>10. Appendix</b> .....	<b>49</b>
10.1. <i>Appendix A: DTS Bandwidth</i> .....	49
10.1.1. Test Result.....	49
10.1.2. Test Graphs .....	50
10.2. <i>Appendix B: Occupied Channel Bandwidth</i> .....	51
10.2.1. Test Result.....	51
10.2.2. Test Graphs .....	52
10.3. <i>Appendix C: Maximum Peak Conducted Output Power</i> .....	53
10.3.1. Test Result.....	53
10.4. <i>Appendix D: Maximum Power Spectral Density</i> .....	54
10.4.1. Test Result.....	54
10.4.2. Test Graphs .....	55
10.5. <i>Appendix E: Band Edge Measurements</i> .....	56
10.5.1. Test Result.....	56
10.5.2. Test Graphs .....	57
10.6. <i>Appendix F: Conducted Spurious Emission</i> .....	58
10.6.1. Test Result.....	58
10.6.2. Test Graphs .....	59
10.7. <i>Appendix G: Duty Cycle</i> .....	62
10.7.1. Test Result.....	62
10.7.2. Test Graphs .....	63



# 1. ATTESTATION OF TEST RESULTS

## Applicant Information

Company Name: TEN PAO PRECISION ELECTRONICS COMPANY LIMITED  
Address: RM 610-611 6/F KWONG SANG HONG CENTRE 151-153 HOI BUN RD KWUN TONG KL HONGKONG CHINA

## Manufacturer Information

Company Name: TEN PAO PRECISION TECHNOLOGY (HUIZHOU) COMPANY LIMITED  
Address: Block A, 27 Xianghe Avenue, Dongjiang Industrial Zone, Shuikou Street Office, Huicheng District, Huizhou City, Guangdong Province, China

## EUT Information

EUT Name: PRECISION ANCHOR/PRECISION TAG  
Model: S001CE0300001  
Serial Model: DMI-WP-TAG-001, DMTGWPWMBTXX, DMANWPWMBTXX  
Model Difference: Please refer to clause 5.1 DESCRIPTION OF EUT  
Brand: 

Sample Received Date: June 2, 2022  
Sample Status: Normal  
Sample ID: 5021067  
Date of Tested: June 8, 2022 ~ June 14, 2022

APPLICABLE STANDARDS	
STANDARD	TEST RESULTS
CFR 47 FCC PART 15 SUBPART C	PASS
ISED RSS-247 Issue 2	PASS
ISED RSS-GEN Issue 5	PASS

Prepared By:

Denny Huang  
Project Engineer

Checked By:

Shawn Wen  
Laboratory Leader

Approved By:

Stephen Guo  
Laboratory Manager



## 2. TEST METHODOLOGY

The tests documented in this report were performed in accordance with KDB 558074 D01 15.247 Meas Guidance v05r02, KDB 414788 D01 Radiated Test Site v01r01, CFR 47 FCC Part 2, CFR 47 FCC Part 15, ANSI C63.10-2013.

## 3. FACILITIES AND ACCREDITATION

Accreditation Certificate	<p><b>A2LA (Certificate No.: 4102.01)</b> UL Verification Services (Guangzhou) Co., Ltd. Song Shan Lake Branch. has been assessed and proved to be in compliance with A2LA.</p> <p><b>FCC (FCC Designation No.: CN1187)</b> UL Verification Services (Guangzhou) Co., Ltd. Song Shan Lake Branch. Has been recognized to perform compliance testing on equipment subject to the Commission's Declaration of Conformity (DoC) and Certification rules</p> <p><b>ISED (Company No.: 21320)</b> UL Verification Services (Guangzhou) Co., Ltd. Song Shan Lake Branch. has been registered and fully described in a report filed with ISED. The Company Number is 21320 and the test lab Conformity Assessment Body Identifier (CABID) is CN0046.</p> <p><b>VCCI (Registration No.: G-20019, R-20004, C-20012 and T-20011)</b> UL Verification Services (Guangzhou) Co., Ltd. Song Shan Lake Branch. has been assessed and proved to be in compliance with VCCI, the Membership No. is 3793. Facility Name: Chamber D, the VCCI registration No. is G-20019 and R-20004 Shielding Room B , the VCCI registration No. is C-20012 and T-20011</p>
---------------------------	---

Note 1: All tests measurement facilities use to collect the measurement data are located at Building 10, Innovation Technology Park, Song Shan Lake Hi tech Development Zone, Dongguan, 523808, China

Note 2: The test anechoic chamber in UL Verification Services (Guangzhou) Co., Ltd. Song Shan Lake Branch had been calibrated and compared to the open field sites and the test anechoic chamber is shown to be equivalent to or worst case from the open field site.

Note 3: For below 30 MHz, lab had performed measurements at test anechoic chamber and comparing to measurements obtained on an open field site. And these measurements below 30 MHz had been correlated to measurements performed on an OFS.



## 4. CALIBRATION AND UNCERTAINTY

### 4.1. MEASURING INSTRUMENT CALIBRATION

The measuring equipment utilized to perform the tests documented in this report has been calibrated in accordance with the manufacturer's recommendations and is traceable to recognize national standards.

### 4.2. MEASUREMENT UNCERTAINTY

Where relevant, the following measurement uncertainty levels have been estimated for tests performed on the apparatus:

Test Item	Uncertainty
Conduction emission	3.62 dB
Radiated Emission (Included Fundamental Emission) (9 kHz ~ 30 MHz)	2.2 dB
Radiated Emission (Included Fundamental Emission) (30 MHz ~ 1 GHz)	4.00 dB
Radiated Emission (Included Fundamental Emission) (1 GHz to 26 GHz)	5.78 dB (1 GHz ~ 18 GHz)
	5.23 dB (18 GHz ~ 26 GHz)

Note: This uncertainty represents an expanded uncertainty expressed at approximately the 95 % confidence level using a coverage factor of k=2.



## 5. EQUIPMENT UNDER TEST

### 5.1. DESCRIPTION OF EUT

EUT Name	PRECISION ANCHOR/PRECISION TAG	
Model	S001CE0300001	
Serial Model	DMI-WP-TAG-001, DMTGWPWMBTXX, DMANWPWMBTXX	
Model Difference	DMI-WP-TAG-001, DMTGWPWMBTXX, DMANWPWMBTXX have the same technical construction including circuit diagram, PCB Layout, components and component layout, all electrical construction and mechanical construction with S001CE0300001. The difference lies only the model number.	
Technology	Bluetooth - Low Energy	
Transmit Frequency Range	2402 MHz ~ 2480 MHz	
Modulation	GFSK	
Data Rate	BLE_1M	1 Mbps
Ratings	DC 3.0 V	

### 5.2. CHANNEL LIST

Channel	Frequency (MHz)	Channel	Frequency (MHz)	Channel	Frequency (MHz)	Channel	Frequency (MHz)
0	2402	11	2424	22	2446	33	2468
1	2404	12	2426	23	2448	34	2470
2	2406	13	2428	24	2450	35	2472
3	2408	14	2430	25	2452	36	2474
4	2410	15	2432	26	2454	37	2476
5	2412	16	2434	27	2456	38	2478
6	2414	17	2436	28	2458	39	2480
7	2416	18	2438	29	2460	/	/
8	2418	19	2440	30	2462	/	/
9	2420	20	2442	31	2464	/	/
10	2422	21	2444	32	2468	/	/

### 5.3. MAXIMUM PEAK OUTPUT POWER

Test Mode	Frequency (MHz)	Channel Number	Maximum Peak Output Power (dBm)
BLE_1M	2402 ~ 2480	0-39[40]	-6.27

#### 5.4. TEST CHANNEL CONFIGURATION

Test Mode	Test Channel	Frequency
BLE_1M	CH 0(Low Channel), CH 19(MID Channel), CH 39(High Channel)	2402 MHz, 2440 MHz, 2480 MHz

#### 5.5. THE WORSE CASE POWER SETTING PARAMETER

The Worst Case Power Setting Parameter under 2400 ~ 2483.5MHz Band				
Test Software Version		nRF Connect		
Test Mode	Test Software setting value	Test Software setting value		
		CH 0	CH 19	CH 39
BLE_1M	1	-8	-8	-8

#### 5.6. DESCRIPTION OF AVAILABLE ANTENNAS

Antenna	Frequency (MHz)	Antenna Type	Maximum Antenna Gain (dBi)
1	2402-2480	PCB	-1.69

Test Mode	Transmit and Receive Mode	Description
BLE_1M	<input checked="" type="checkbox"/> 1TX, 1RX	Antenna 1 can be used as transmitting/receiving antenna.

## 5.7. DESCRIPTION OF TEST SETUP

### SUPPORT EQUIPMENT

Item	Equipment	Brand Name	Model Name	Remarks
1	Laptop	Lenovo	E42-80	/
2	USB TO Serial Board	/	/	/

### I/O CABLES

Cable No	Port	Connector Type	Cable Type	Cable Length(m)	Remarks
/	/	/	/	/	/

### ACCESSORIES

Item	Accessory	Brand Name	Model Name	Description
/	/	/	/	/

### TEST SETUP

The EUT can work in engineering mode with a software.  
New battery was used during test.

### SETUP DIAGRAM FOR TESTS

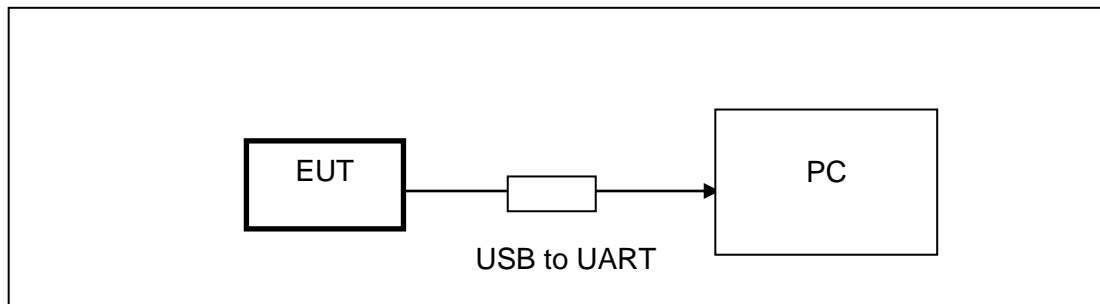

**6. MEASURING INSTRUMENT AND SOFTWARE USED**

Conducted Emissions					
Equipment	Manufacturer	Model No.	Serial No.	Last Cal.	Due Date
EMI Test Receiver	R&S	ESR3	101961	Oct.30, 2021	Oct.29, 2022
Two-Line V- Network	R&S	ENV216	101983	Oct.30, 2021	Oct.29, 2022
Software					
Description		Manufacturer	Name	Version	
Test Software for Conducted Emissions		Farad	EZ-EMC	Ver. UL-3A1	

Radiated Emissions					
Equipment	Manufacturer	Model No.	Serial No.	Last Cal.	Due Date
MXE EMI Receiver	KESIGHT	N9038A	MY56400036	Oct.30, 2021	Oct.29, 2022
Hybrid Log Periodic Antenna	TDK	HLP-3003C	130959	Aug.02, 2021	Aug.01, 2024
Preamplifier	HP	8447D	2944A09099	Oct.30, 2021	Oct.29, 2022
EMI Measurement Receiver	R&S	ESR26	101377	Oct.30, 2021	Oct.29, 2022
Horn Antenna	TDK	HRN-0118	130940	July 20, 2021	July 19, 2024
Preamplifier	TDK	PA-02-0118	TRS-305- 00067	Oct.30, 2021	Oct.29, 2022
Horn Antenna	Schwarzbeck	BBHA9170	697	July 20, 2021	July 19, 2024
Preamplifier	TDK	PA-02-2	TRS-307- 00003	Oct.31, 2021	Oct.30, 2022
Preamplifier	TDK	PA-02-3	TRS-308- 00002	Oct.31, 2021	Oct.30, 2022
Loop antenna	Schwarzbeck	1519B	00008	Dec.14, 2021	Dec.13, 2024
Preamplifier	TDK	PA-02-001- 3000	TRS-302- 00050	Oct.31, 2021	Oct.30, 2022
High Pass Filter	Wi	WHKX10- 2700-3000- 18000-40SS	23	Oct.31, 2021	Oct.30, 2022
Band Reject Filter	Wainwright	WRCJV8- 2350-2400- 2483.5- 2533.5-40SS	4	Oct.31, 2021	Oct.30, 2022
Software					
Description		Manufacturer	Name	Version	
Test Software for Radiated Emissions		Farad	EZ-EMC	Ver. UL-3A1	



Other Instruments					
Equipment	Manufacturer	Model No.	Serial No.	Last Cal.	Next Cal.
Signal Analyzer	R&S	FSV40	101118	Oct.30, 2021	Oct.29, 2022
Dual Channel Power Meter	Keysight	N1912A	MY55416024	Oct.30, 2021	Oct.29, 2022
Power Sensor	Keysight	USB Wideband Power Sensor	MY5100022	Oct.30, 2021	Oct.29, 2022

## 7. ANTENNA PORT TEST RESULTS

### 7.1. ON TIME AND DUTY CYCLE

#### LIMITS

None; for reporting purposes only.

#### PROCEDURE

Refer to ANSI C63.10-2013 clause 11.6 Zero – Span Spectrum Analyzer method.

#### TEST SETUP

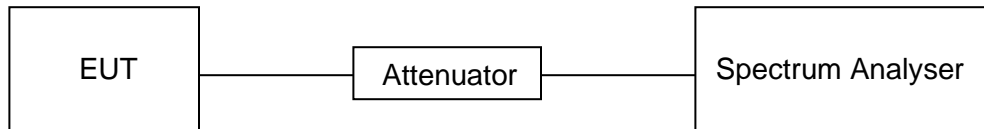

#### TEST ENVIRONMENT

Temperature	24.8 °C	Relative Humidity	56 %
Atmosphere Pressure	101 kPa	Test Voltage	DC 3.0 V

#### RESULTS

Please refer to appendix G.

## 7.2. 6 dB DTS BANDWIDTH AND 99 % OCCUPIED BANDWIDTH

### LIMITS

CFR 47FCC Part15 (15.247) Subpart C			
Section	Test Item	Limit	Frequency Range (MHz)
CFR 47 FCC 15.247(a)(2) ISED RSS-247 5.2 (a)	6 dB Bandwidth	≥ 500 kHz	2400-2483.5
ISED RSS-Gen Clause 6.7	99 % Occupied Bandwidth	None; for reporting purposes only.	2400-2483.5

### TEST PROCEDURE

Refer to ANSI C63.10-2013 clause 11.8 for DTS bandwidth and clause 6.9 for Occupied Bandwidth.

Connect the EUT to the spectrum analyser and use the following settings:

Center Frequency	The center frequency of the channel under test
Frequency Span	For 6 dB Bandwidth: Enough to capture all products of the modulation carrier emission For 99 % Occupied Bandwidth: Between 1.5 times and 5.0 times the OBW
Detector	Peak
RBW	For 6 dB Bandwidth: 100 kHz For 99 % Occupied Bandwidth: 1 % to 5 % of the occupied bandwidth
VBW	For 6 dB Bandwidth: ≥3 × RBW For 99 % Occupied Bandwidth: ≥3 × RBW
Trace	Max hold
Sweep	Auto couple

a) Use the 99 % power bandwidth function of the instrument, allow the trace to stabilize and report the measured bandwidth.

b) Allow the trace to stabilize and measure the maximum width of the emission that is constrained by the frequencies associated with the two outermost amplitude points (upper and lower frequencies) that are attenuated by 6 dB relative to the maximum level measured in the fundamental emission.

### TEST SETUP

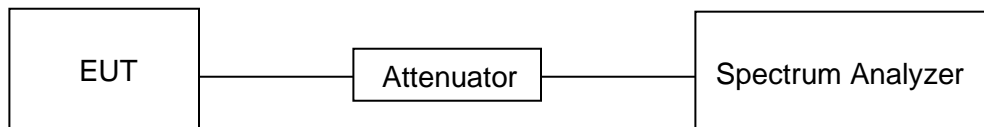



**TEST ENVIRONMENT**

Temperature	24.8 °C	Relative Humidity	56 %
Atmosphere Pressure	101 kPa	Test Voltage	DC 3.0 V

**RESULTS**

Please refer to appendix A & B.



### 7.3. CONDUCTED OUTPUT POWER

#### LIMITS

CFR 47 FCC Part15 (15.247) Subpart C			
Section	Test Item	Limit	Frequency Range (MHz)
CFR 47 FCC 15.247(b)(3)	Peak Conducted Output Power	1 watt or 30 dBm	2400-2483.5

#### TEST PROCEDURE

Connect the EUT to a low loss RF cable from the antenna port to the power sensor (video bandwidth is greater than the occupied bandwidth). Measure peak emission level, the indicated level is the peak output power, after any corrections for external attenuators and cables.

#### TEST SETUP

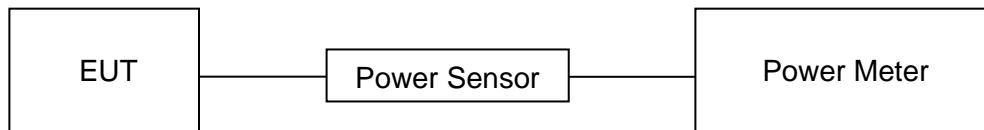

#### TEST ENVIRONMENT

Temperature	24.8 °C	Relative Humidity	56 %
Atmosphere Pressure	101 kPa	Test Voltage	DC 3.0 V

#### RESULTS

Please refer to appendix C.

## 7.4. POWER SPECTRAL DENSITY

### LIMITS

CFR 47 FCC Part15 (15.247) Subpart C			
Section	Test Item	Limit	Frequency Range (MHz)
CFR 47 FCC §15.247 (e)	Power Spectral Density	8 dBm in any 3 kHz band	2400-2483.5

### TEST PROCEDURE

Refer to ANSI C63.10-2013 clause 11.10.

Connect the EUT to the spectrum analyser and use the following settings:

Center Frequency	The center frequency of the channel under test
Detector	Peak
RBW	$3 \text{ kHz} \leq \text{RBW} \leq 100 \text{ kHz}$
VBW	$\geq 3 \times \text{RBW}$
Span	1.5 x DTS bandwidth
Trace	Max hold
Sweep time	Auto couple

Allow trace to fully stabilize and use the peak marker function to determine the maximum amplitude level within the RBW.

If measured value exceeds limit, reduce RBW (no less than 3 kHz) and repeat.

### TEST SETUP

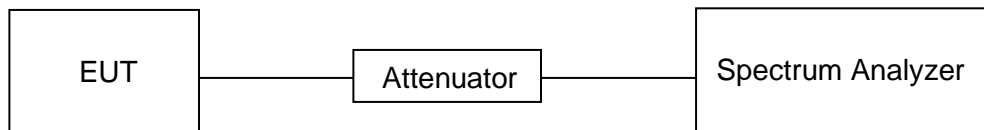

### TEST ENVIRONMENT

Temperature	24.8 °C	Relative Humidity	56 %
Atmosphere Pressure	101 kPa	Test Voltage	DC 3.0 V



**RESULTS**

Please refer to appendix D.

## 7.5. CONDUCTED BANDEGE AND SPURIOUS EMISSIONS

### LIMITS

CFR 47 FCC Part15 (15.247) Subpart C		
Section	Test Item	Limit
CFR 47 FCC §15.247 (d)	Conducted Bandedge and Spurious Emissions	at least 20 dB below that in the 100 kHz bandwidth within the band that contains the highest level of the desired power

### TEST PROCEDURE

Refer to ANSI C63.10-2013 clause 11.11 and 11.13.

Connect the EUT to the spectrum analyser and use the following settings for reference level measurement:

Center Frequency	The center frequency of the channel under test
Detector	Peak
RBW	100 kHz
VBW	$\geq 3 \times \text{RBW}$
Span	1.5 x DTS bandwidth
Trace	Max hold
Sweep time	Auto couple.

Allow trace to fully stabilize and use the peak marker function to determine the maximum PSD level.

Change the settings for emission level measurement:

Span	Set the center frequency and span to encompass frequency range to be measured
Detector	Peak
RBW	100 kHz
VBW	$\geq 3 \times \text{RBW}$
measurement points	$\geq \text{span}/\text{RBW}$
Trace	Max hold
Sweep time	Auto couple.

Allow trace to fully stabilize and use the peak marker function to determine the maximum PSD level. Ensure that the amplitude of all unwanted emissions outside of the authorized frequency band (excluding restricted frequency bands) is attenuated by at least the minimum requirements specified in 11.11.

### TEST SETUP

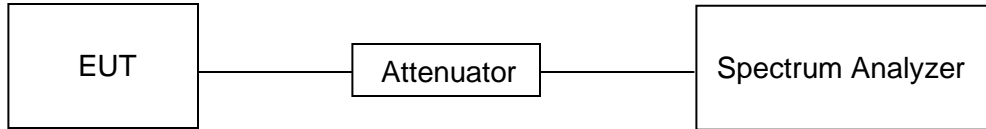

**TEST ENVIRONMENT**

Temperature	24.8 °C	Relative Humidity	56 %
Atmosphere Pressure	101 kPa	Test Voltage	DC 3.0 V

**RESULTS**

Please refer to appendix E & F.



## 8. RADIATED TEST RESULTS

### LIMITS

Please refer to CFR 47 FCC §15.205 and §15.209.

Radiation Disturbance Test Limit for FCC (Class B) (9 kHz-1 GHz)

Emissions radiated outside of the specified frequency bands above 30 MHz			
Frequency Range (MHz)	Field Strength Limit (uV/m) at 3 m	Field Strength Limit (dBuV/m) at 3 m	
		Quasi-Peak	
30 - 88	100	40	
88 - 216	150	43.5	
216 - 960	200	46	
Above 960	500	54	
Above 1000	500	Peak	Average
		74	54

FCC Emissions radiated outside of the specified frequency bands below 30 MHz		
Frequency (MHz)	Field strength (microvolts/meter)	Measurement distance (meters)
0.009-0.490	2400/F(kHz)	300
0.490-1.705	24000/F(kHz)	30
1.705-30.0	30	30

FCC Restricted bands of operation refer to FCC §15.205 (a):

MHz	MHz	MHz	GHz
0.090-0.110	16.42-16.423	399.9-410	4.5-5.15
<sup>1</sup> 0.495-0.505	16.69475-16.69525	608-614	5.35-5.46
2.1735-2.1905	16.80425-16.80475	960-1240	7.25-7.75
4.125-4.128	25.5-25.67	1300-1427	8.025-8.5
4.17725-4.17775	37.5-38.25	1435-1626.5	9.0-9.2
4.20725-4.20775	73-74.6	1645.5-1646.5	9.3-9.5
6.215-6.218	74.8-75.2	1660-1710	10.6-12.7
6.26775-6.26825	108-121.94	1718.8-1722.2	13.25-13.4
6.31175-6.31225	123-138	2200-2300	14.47-14.5
8.291-8.294	149.9-150.05	2310-2390	15.35-16.2
8.362-8.366	156.52475-156.52525	2483.5-2500	17.7-21.4
8.37625-8.38675	156.7-156.9	2690-2900	22.01-23.12
8.41425-8.41475	162.0125-167.17	3260-3267	23.6-24.0
12.29-12.293	167.72-173.2	3332-3339	31.2-31.8
12.51975-12.52025	240-285	3345.8-3358	36.43-36.5
12.57675-12.57725	322-335.4	3600-4400	( <sup>2</sup> )
13.36-13.41			

Note: <sup>1</sup>Until February 1, 1999, this restricted band shall be 0.490-0.510 MHz.

<sup>2</sup>Above 38.6c

**TEST SETUP AND PROCEDURE**

Below 30 MHz

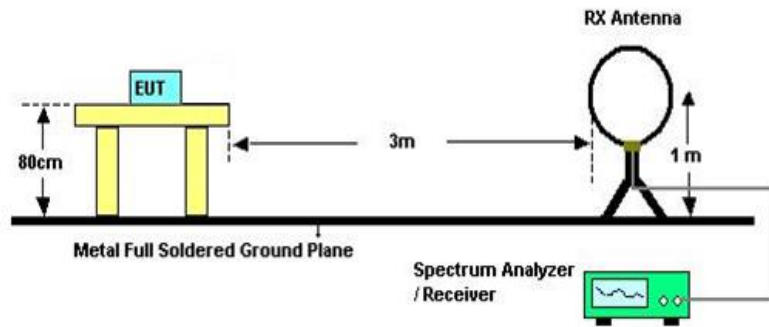

The setting of the spectrum analyser

RBW	200 Hz (From 9 kHz to 0.15 MHz)/ 9 kHz (From 0.15 MHz to 30 MHz)
VBW	200 Hz (From 9 kHz to 0.15 MHz)/ 9 kHz (From 0.15 MHz to 30 MHz)
Sweep	Auto
Trace	Max hold

1. The testing follows the guidelines in ANSI C63.10-2013 clause 11.11.
2. The EUT was arranged to its worst case and then turntable (from 0 degree to 360 degrees) to find the maximum reading. A pre-amp and a high pass filter are used for the test in order to get better signal level. Both Horizontal, Face-on and Face-off polarizations of the antenna are set to make the measurement.
3. The EUT was placed on a turntable with 80 cm above ground.
4. The EUT was set 3 meters from the interference receiving antenna, which was mounted on the top of a 1 m height antenna tower.
5. The radiated emission limits are based on measurements employing a CISPR quasi-peak detector except for the frequency bands 9-90 kHz, 110-490 kHz and above 1000 MHz. Radiated emission limits in these three bands are based on measurements employing an average detector.
6. For measurement below 1 GHz, the initial step in collecting conducted emission data is a spectrum analyzer peak detector mode pre-scanning the measurement frequency range. Significant peaks are then marked and then Quasi Peak and average detector mode re-measured. If the emission level of the EUT measured by the peak detector is 3 dB lower than the applicable limit, the peak emission level will be reported. Otherwise, the emission measurement will be repeated using the quasi-peak and average detector and reported.
7. Although these tests were performed other than open field site, adequate comparison measurements were confirmed against 30m open field site. Therefore sufficient tests were made to demonstrate that the alternative site produces results that correlate with the ones of tests made in an open field site based on KDB 414788.
8. The limits in CFR 47, Part 15, Subpart C, paragraph 15.209 (a), are identical to those in RSS-GEN Section 8.9, Table 6, since the measurements are performed in terms of magnetic field strength and converted to electric field strength levels (as reported in the table) using the free space impedance of  $377 \Omega$ ; For example, the measurement frequency X kHz resulted in a level of Y dBuV/m, which is equivalent to  $Y-51.5 = Z$  dBuA/m, which has the same margin, W dB, to the corresponding RSS-GEN Table 6 limit as it has to be 15.209(a) limit.

Below 1 GHz and above 30 MHz

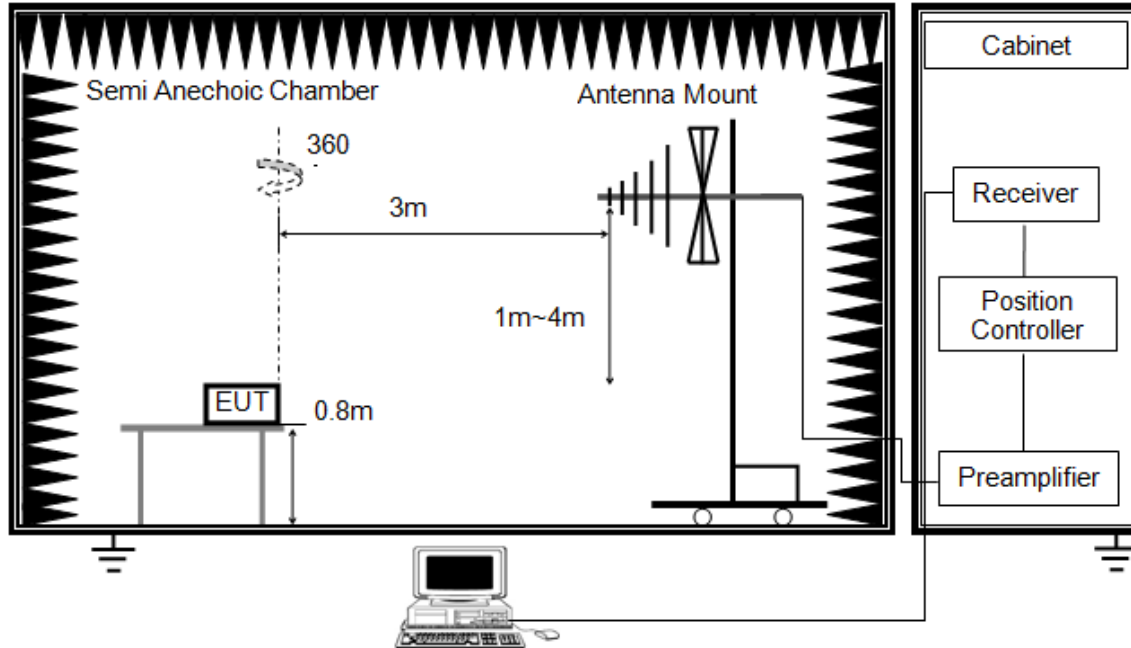

The setting of the spectrum analyser

RBW	120 kHz
VBW	300 kHz
Sweep	Auto
Detector	Peak/QP
Trace	Max hold

1. The testing follows the guidelines in ANSI C63.10-2013 clause 11.11.
2. The EUT was arranged to its worst case and then tune the antenna tower (from 1 m to 4 m) and turntable (from 0 degree to 360 degrees) to find the maximum reading. A pre-amp and a high pass filter are used for the test in order to get better signal level. Both horizontal and vertical polarizations of the antenna are set to make the measurement.
3. The EUT was placed on a turntable with 80 cm above ground.
4. The EUT was set 3 meters from the interference receiving antenna, which was mounted on the top of a variable height antenna tower.
5. For measurement below 1 GHz, the initial step in collecting conducted emission data is a spectrum analyzer peak detector mode pre-scanning the measurement frequency range. Significant peaks are then marked and then Quasi Peak detector mode re-measured. If the emission level of the EUT measured by the peak detector is 3 dB lower than the applicable limit, the peak emission level will be reported. Otherwise, the emission measurement will be repeated using the quasi-peak detector and reported.



Above 1 GHz

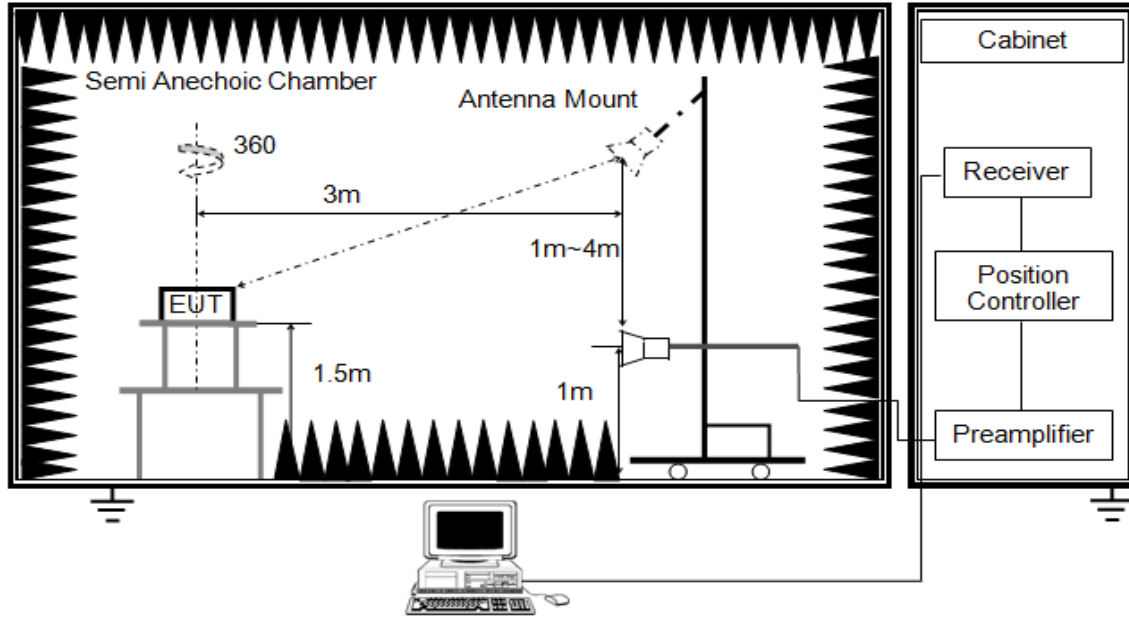

The setting of the spectrum analyser

RBW	1 MHz
VBW	PEAK: 3 MHz AVG: see note 6
Sweep	Auto
Detector	Peak
Trace	Max hold

1. The testing follows the guidelines in ANSI C63.10-2013 clause 11.11 and 11.12.
2. The EUT was arranged to its worst case and then tune the antenna tower (1.5 m) and turntable (from 0 degree to 360 degrees) to find the maximum reading. A pre-amp and a high pass filter are used for the test in order to get better signal level. Both horizontal and vertical polarizations of the antenna are set to make the measurement.
3. The EUT was placed on a turntable with 1.5 m above ground.
4. The EUT was set 3 meters from the interference receiving antenna, which was mounted on the top of a variable height antenna tower.
5. For measurement above 1 GHz, the emission measurement will be measured by the peak detector. This peak level, once corrected, must comply with the limit specified in Section 15.209.
6. For measurements above 1 GHz the resolution bandwidth is set to 1 MHz, then the video bandwidth is set to 3 MHz for peak measurements and 1 MHz resolution bandwidth with 1/T video bandwidth with peak detector for average measurements. For the Duty Cycle please refer to clause 7.1.ON TIME AND DUTY CYCLE.

X axis, Y axis, Z axis positions:

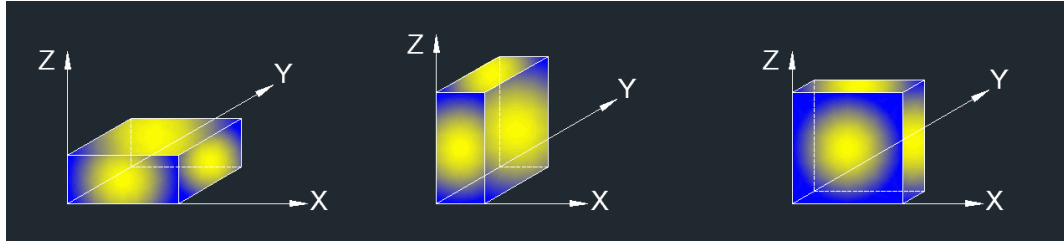

Note 1: For all radiated test, EUT in each of three orthogonal axis emissions had been tested, but only the worst case (X axis) data recorded in the report.

Note 2: The EUT was fully exercised with external accessories during the test. In the case of multiple accessory external ports, an external accessory shall be connected to one of each type of port.

**TEST ENVIRONMENT**

Temperature	24.3 °C	Relative Humidity	61 %
Atmosphere Pressure	101 kPa	Test Voltage	DC 3.0 V

**RESULTS**

## 8.1. RESTRICTED BANDEDGE

### 8.1.1. BLE\_1M MODE

#### RESTRICTED BANDEDGE (LOW CHANNEL, VERTICAL)

#### PEAK

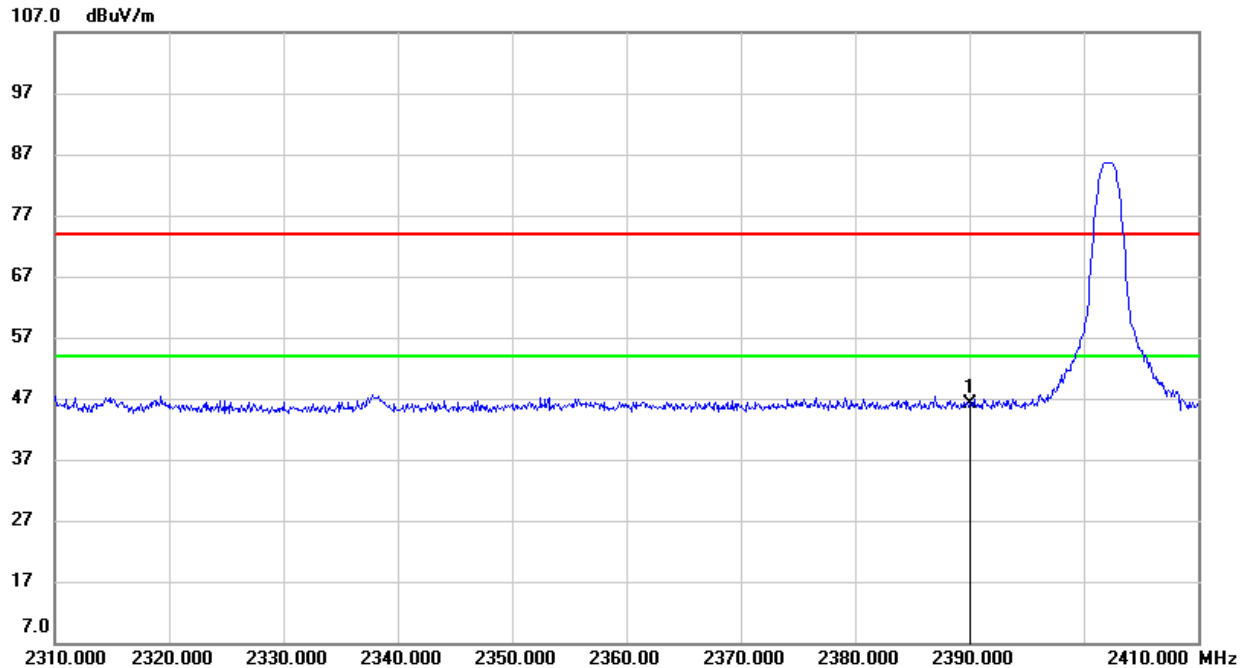

No.	Frequency (MHz)	Reading (dBuV)	Correct (dB/m)	Result (dBuV/m)	Limit (dBuV/m)	Margin (dB)	Remark
1	2390.000	14.06	32.16	46.22	74.00	-27.78	peak

- Note: 1. Measurement = Reading Level + Correct Factor.  
 2. If Peak Result complies with AV limit, AV Result is deemed to comply with AV limit.  
 3. Peak: Peak detector.  
 4. Only the worst data was recorded, if it complies with the limit, the other emissions deemed to comply with the limit.



**RESTRICTED BANDEDGE (HIGH CHANNEL, VERTICAL)**

**PEAK**

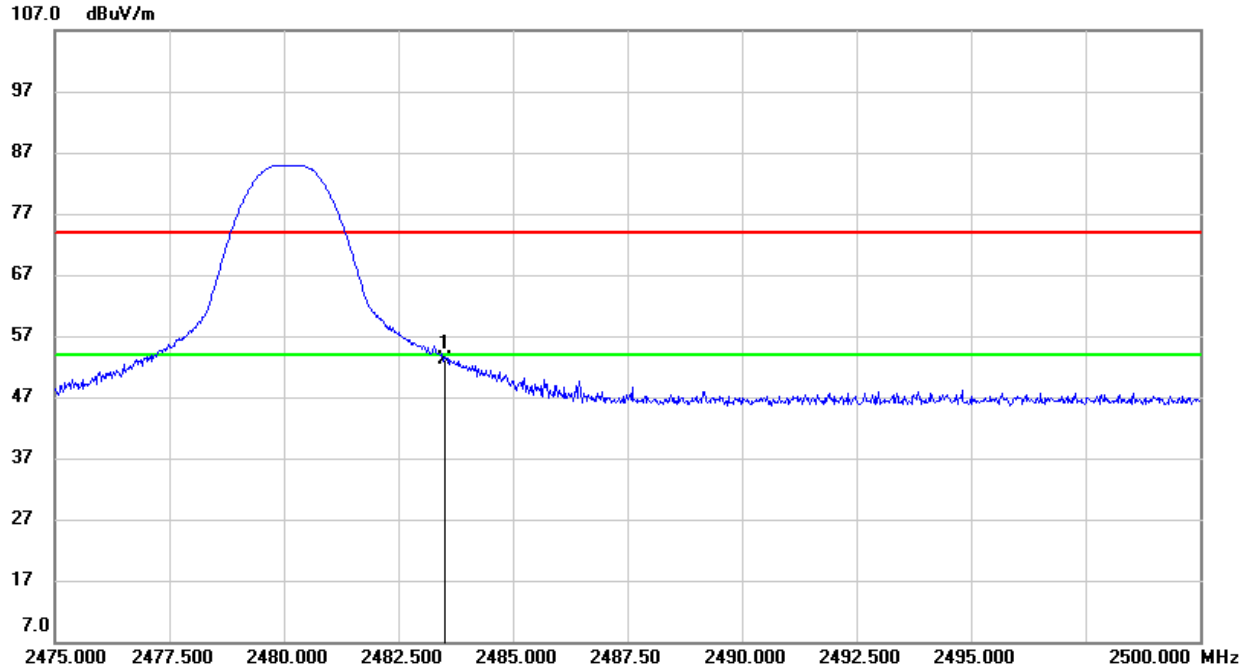

No.	Frequency (MHz)	Reading (dBuV)	Correct (dB/m)	Result (dBuV/m)	Limit (dBuV/m)	Margin (dB)	Remark
1	2483.500	20.81	32.44	53.25	74.00	-20.75	peak

- Note: 1. Measurement = Reading Level + Correct Factor.  
 2. If Peak Result complies with AV limit, AV Result is deemed to comply with AV limit.  
 3. Peak: Peak detector.  
 4. Only the worst data was recorded, if it complies with the limit, the other emissions deemed to comply with the limit.

Note: All the polarities (Vertical & Horizontal) had been tested, only the worst data was recorded in the report.

## 8.2. SPURIOUS EMISSIONS (1 GHz ~ 3 GHz)

### 8.2.1. BLE\_1M MODE

#### HARMONICS AND SPURIOUS EMISSIONS (LOW CHANNEL, HORIZONTAL)

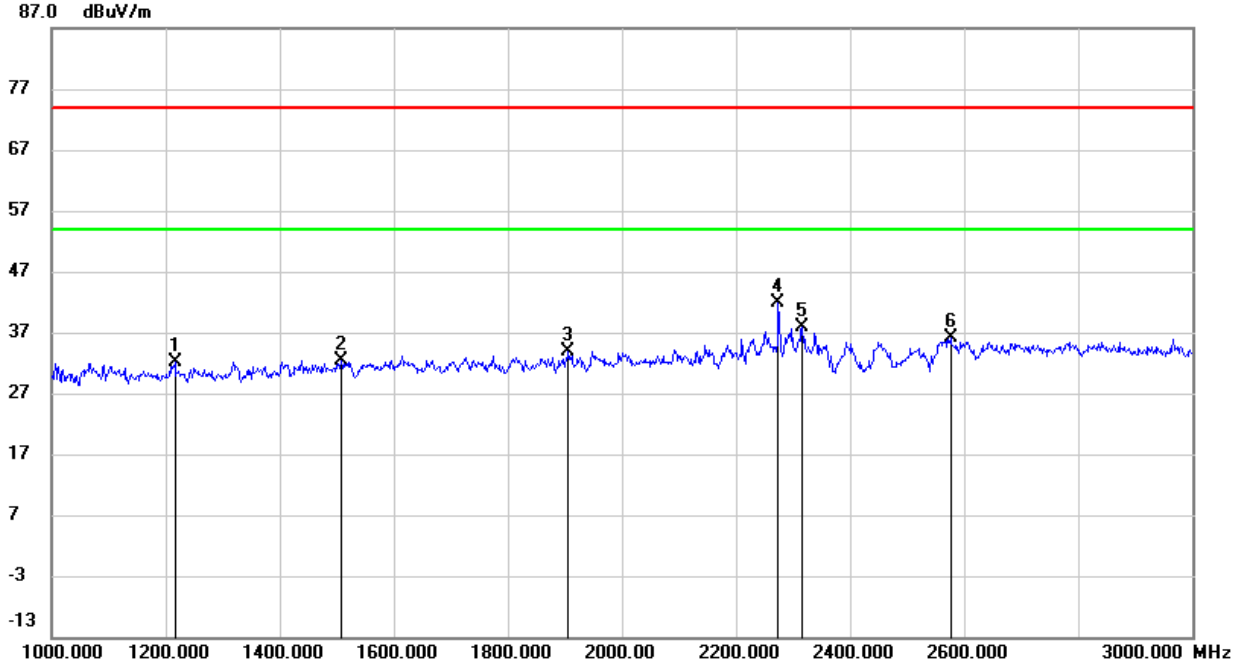

No.	Frequency (MHz)	Reading (dBuV)	Correct (dB/m)	Result (dBuV/m)	Limit (dBuV/m)	Margin (dB)	Remark
1	1216.000	46.15	-13.97	32.18	74.00	-41.82	peak
2	1508.000	44.93	-12.50	32.43	74.00	-41.57	peak
3	1906.000	45.28	-11.29	33.99	74.00	-40.01	peak
4	2274.000	51.45	-9.53	41.92	74.00	-32.08	peak
5	2316.000	47.28	-9.30	37.98	74.00	-36.02	peak
6	2576.000	44.23	-8.11	36.12	74.00	-37.88	peak

- Note:
1. Peak Result = Reading Level + Correct Factor.
  2. If Peak Result complies with AV limit, AV Result is deemed to comply with AV limit.
  3. Peak: Peak detector.
  4. Filter losses were only considered in then spurious frequency bands and the authorized band was not corrected for Band reject filter losses.
  5. Proper operation of the transmitter prior to adding the filter to the measurement chain.

**HARMONICS AND SPURIOUS EMISSIONS (LOW CHANNEL, VERTICAL)**

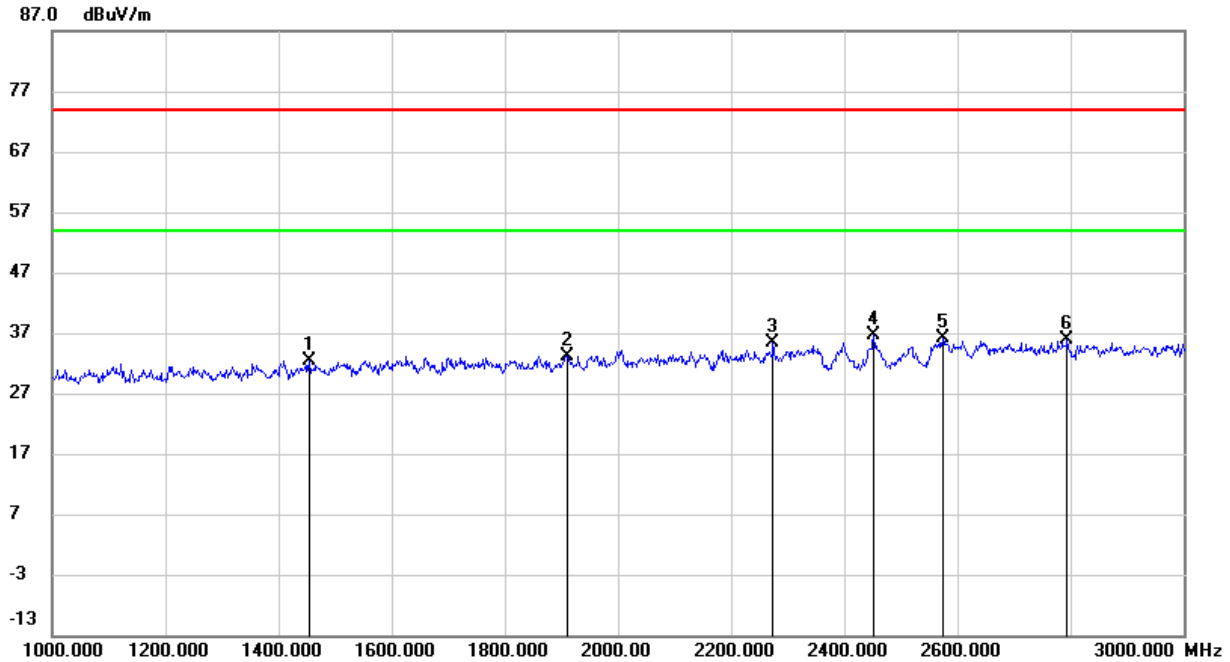

No.	Frequency (MHz)	Reading (dBuV)	Correct (dB/m)	Result (dBuV/m)	Limit (dBuV/m)	Margin (dB)	Remark
1	1454.000	45.20	-12.77	32.43	74.00	-41.57	peak
2	1910.000	44.51	-11.28	33.23	74.00	-40.77	peak
3	2274.000	44.94	-9.53	35.41	74.00	-38.59	peak
4	2452.000	45.20	-8.56	36.64	74.00	-37.36	peak
5	2574.000	44.19	-8.12	36.07	74.00	-37.93	peak
6	2794.000	43.45	-7.53	35.92	74.00	-38.08	peak

- Note:
1. Peak Result = Reading Level + Correct Factor.
  2. If Peak Result complies with AV limit, AV Result is deemed to comply with AV limit.
  3. Peak: Peak detector.
  4. Filter losses were only considered in then spurious frequency bands and the authorized band was not corrected for Band reject filter losses.
  5. Proper operation of the transmitter prior to adding the filter to the measurement chain.

### HARMONICS AND SPURIOUS EMISSIONS (MID CHANNEL, HORIZONTAL)

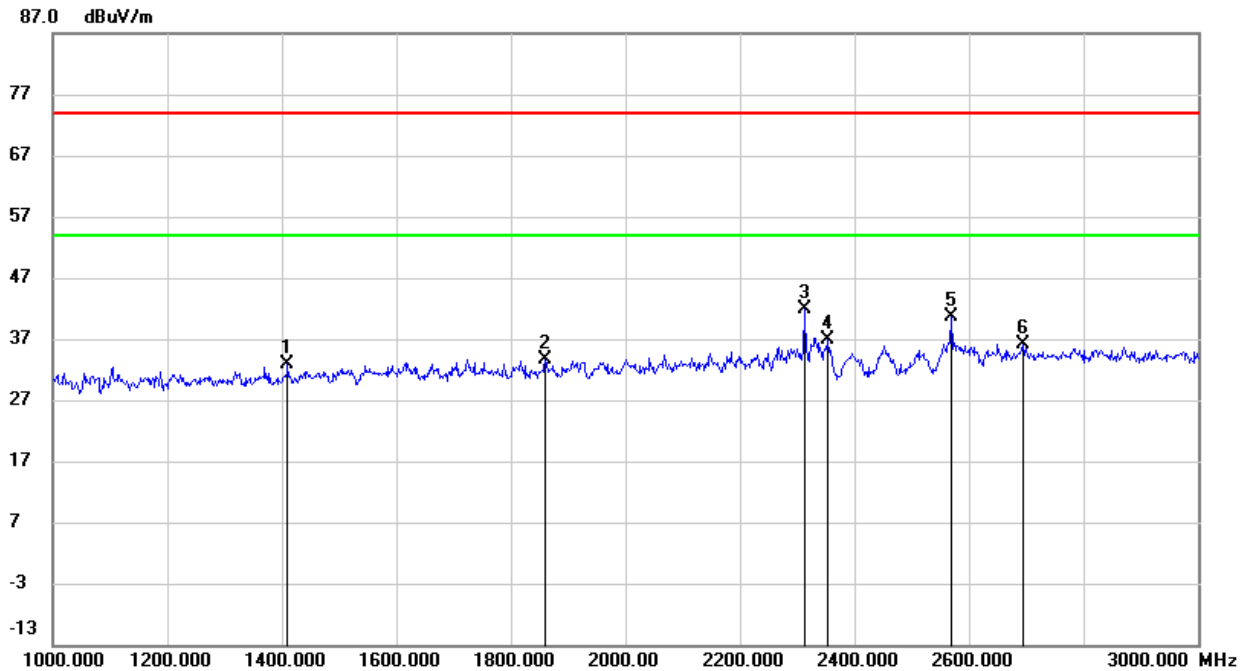

No.	Frequency (MHz)	Reading (dBuV)	Correct (dB/m)	Result (dBuV/m)	Limit (dBuV/m)	Margin (dB)	Remark
1	1410.000	45.78	-12.99	32.79	74.00	-41.21	peak
2	1860.000	45.05	-11.43	33.62	74.00	-40.38	peak
3	2312.000	51.22	-9.32	41.90	74.00	-32.10	peak
4	2354.000	45.87	-9.09	36.78	74.00	-37.22	peak
5	2570.000	48.85	-8.12	40.73	74.00	-33.27	peak
6	2694.000	43.90	-7.79	36.11	74.00	-37.89	peak

- Note:
1. Peak Result = Reading Level + Correct Factor.
  2. If Peak Result complies with AV limit, AV Result is deemed to comply with AV limit.
  3. Peak: Peak detector.
  4. Filter losses were only considered in then spurious frequency bands and the authorized band was not corrected for Band reject filter losses.
  5. Proper operation of the transmitter prior to adding the filter to the measurement chain.

**HARMONICS AND SPURIOUS EMISSIONS (MID CHANNEL, VERTICAL)**

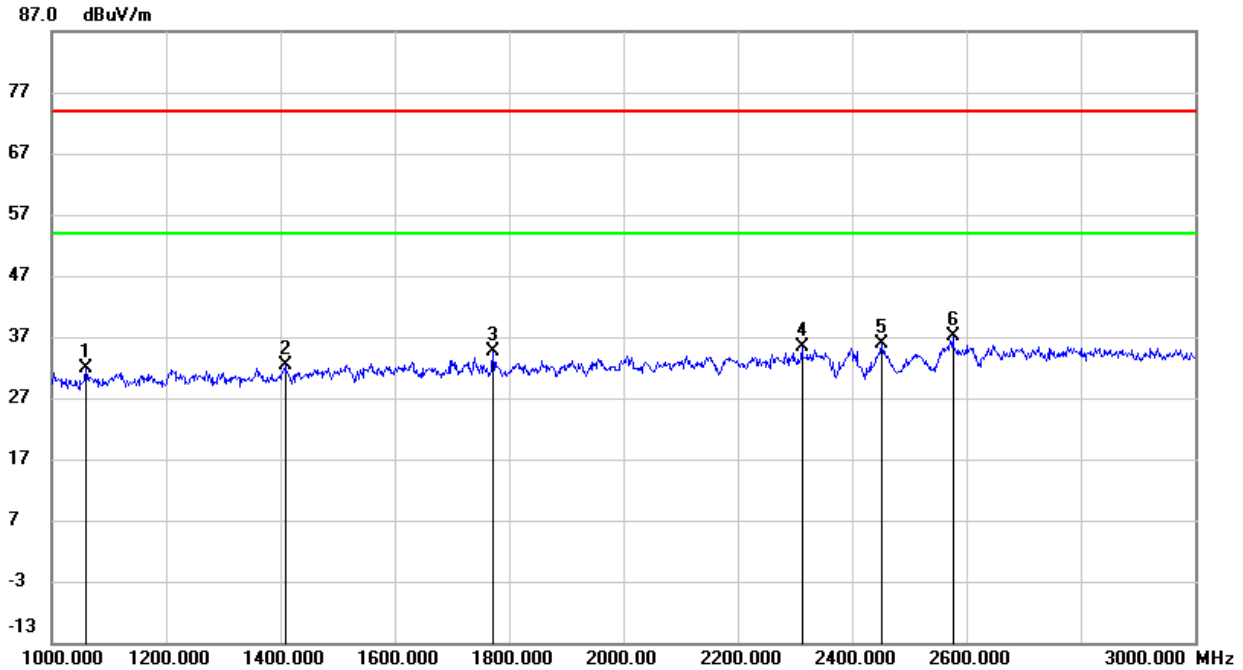

No.	Frequency (MHz)	Reading (dBuV)	Correct (dB/m)	Result (dBuV/m)	Limit (dBuV/m)	Margin (dB)	Remark
1	1060.000	46.75	-14.76	31.99	74.00	-42.01	peak
2	1408.000	45.45	-12.99	32.46	74.00	-41.54	peak
3	1772.000	46.32	-11.70	34.62	74.00	-39.38	peak
4	2312.000	44.59	-9.32	35.27	74.00	-38.73	peak
5	2452.000	44.37	-8.56	35.81	74.00	-38.19	peak
6	2576.000	45.24	-8.11	37.13	74.00	-36.87	peak

- Note: 1. Peak Result = Reading Level + Correct Factor.  
 2. If Peak Result complies with AV limit, AV Result is deemed to comply with AV limit.  
 3. Peak: Peak detector.  
 4. Filter losses were only considered in then spurious frequency bands and the authorized band was not corrected for Band reject filter losses.  
 5. Proper operation of the transmitter prior to adding the filter to the measurement chain.

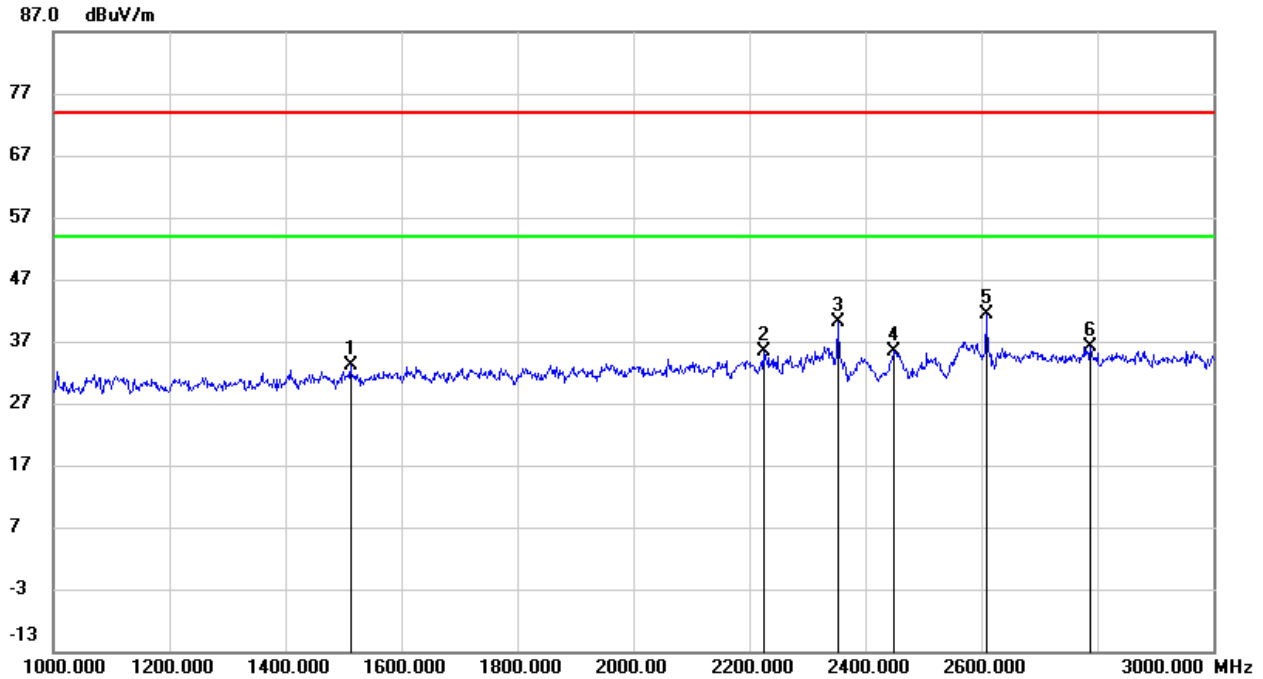

**HARMONICS AND SPURIOUS EMISSIONS (HIGH CHANNEL, HORIZONTAL)**

No.	Frequency (MHz)	Reading (dBuV)	Correct (dB/m)	Result (dBuV/m)	Limit (dBuV/m)	Margin (dB)	Remark
1	1512.000	45.65	-12.49	33.16	74.00	-40.84	peak
2	2224.000	45.05	-9.79	35.26	74.00	-38.74	peak
3	2352.000	49.15	-9.10	40.05	74.00	-33.95	peak
4	2448.000	43.95	-8.60	35.35	74.00	-38.65	peak
5	2608.000	49.44	-8.02	41.42	74.00	-32.58	peak
6	2788.000	43.62	-7.55	36.07	74.00	-37.93	peak

- Note:
1. Peak Result = Reading Level + Correct Factor.
  2. If Peak Result complies with AV limit, AV Result is deemed to comply with AV limit.
  3. Peak: Peak detector.
  4. Filter losses were only considered in then spurious frequency bands and the authorized band was not corrected for Band reject filter losses.
  5. Proper operation of the transmitter prior to adding the filter to the measurement chain.

**HARMONICS AND SPURIOUS EMISSIONS (HIGH CHANNEL, VERTICAL)**

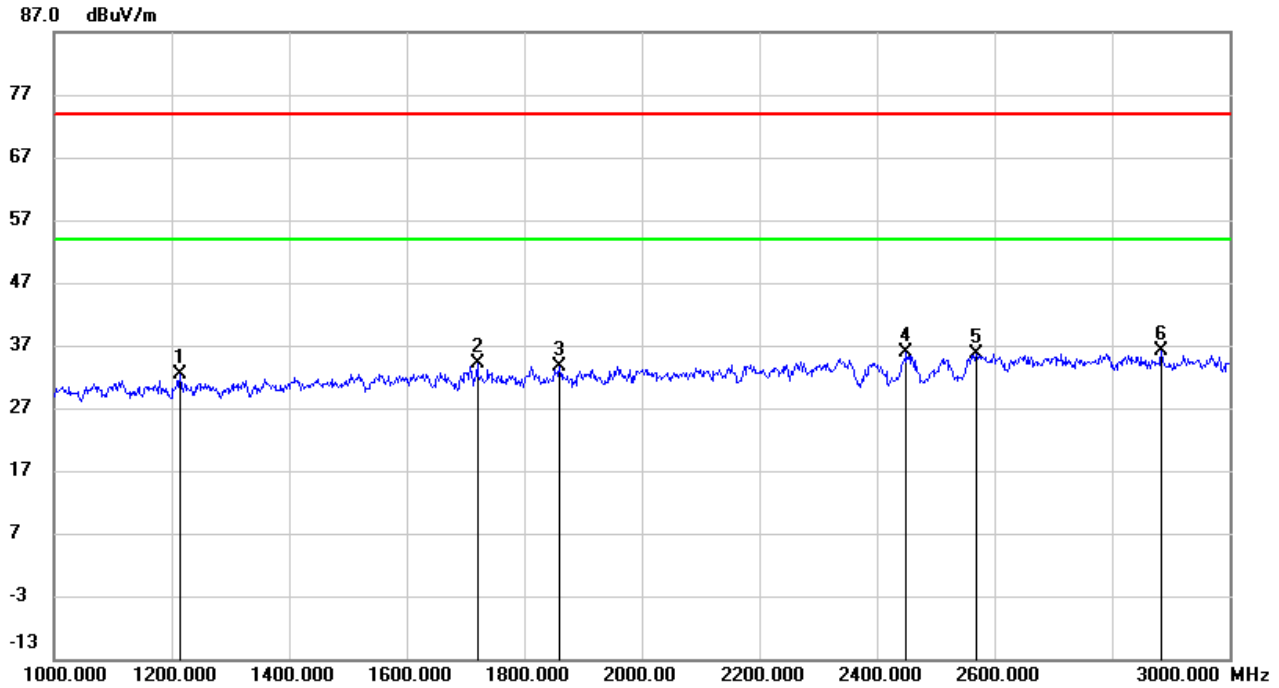

No.	Frequency (MHz)	Reading (dBuV)	Correct (dB/m)	Result (dBuV/m)	Limit (dBuV/m)	Margin (dB)	Remark
1	1214.000	46.31	-13.97	32.34	74.00	-41.66	peak
2	1720.000	45.92	-11.85	34.07	74.00	-39.93	peak
3	1860.000	45.03	-11.43	33.60	74.00	-40.40	peak
4	2450.000	44.35	-8.57	35.78	74.00	-38.22	peak
5	2570.000	43.85	-8.12	35.73	74.00	-38.27	peak
6	2884.000	43.31	-7.30	36.01	74.00	-37.99	peak

- Note:
1. Peak Result = Reading Level + Correct Factor.
  2. If Peak Result complies with AV limit, AV Result is deemed to comply with AV limit.
  3. Peak: Peak detector.
  4. Filter losses were only considered in then spurious frequency bands and the authorized band was not corrected for Band reject filter losses.
  5. Proper operation of the transmitter prior to adding the filter to the measurement chain.

Note: All the modes and channels had been tested, but only the worst data was recorded in the report.

### 8.3. SPURIOUS EMISSIONS (3 GHz ~ 18 GHz)

#### 8.3.1. BLE\_1M MODE

##### HARMONICS AND SPURIOUS EMISSIONS (LOW CHANNEL, HORIZONTAL)

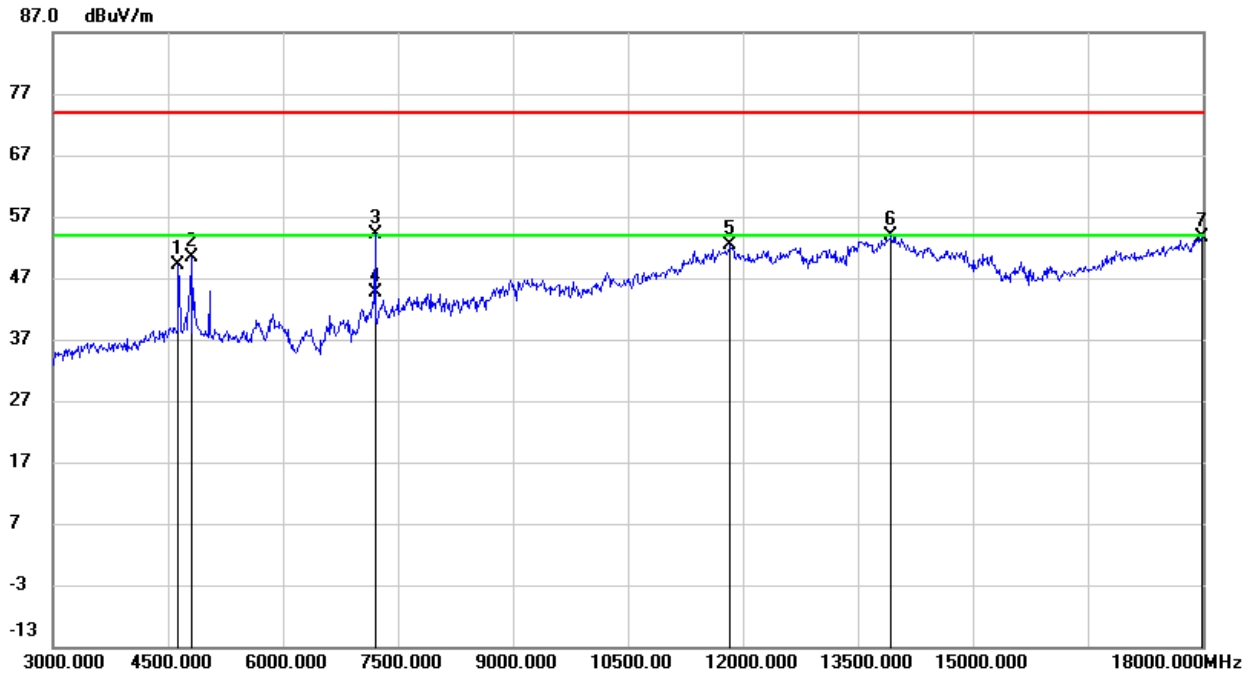

No.	Frequency (MHz)	Reading (dBuV)	Correct (dB/m)	Result (dBuV/m)	Limit (dBuV/m)	Margin (dB)	Remark
1	4635.000	50.58	-1.52	49.06	74.00	-24.94	peak
2	4800.000	51.22	-0.88	50.34	74.00	-23.66	peak
3	7200.000	48.34	5.75	54.09	74.00	-19.91	peak
4	7200.000	38.93	5.75	44.68	54.00	-9.32	AVG
5	11835.000	35.79	16.53	52.32	74.00	-21.68	peak
6	13935.000	32.91	20.91	53.82	74.00	-20.18	peak
7	17985.000	29.08	24.53	53.61	74.00	-20.39	peak

- Note: 1. Peak Result = Reading Level + Correct Factor.  
 2. If Peak Result complies with AV limit, AV Result is deemed to comply with AV limit.  
 3. Peak: Peak detector.  
 4. AVG:  $VBW=1/Ton$ , where: Ton is the transmitting duration.  
 5. For the transmitting duration, please refer to clause 7.1.  
 6. Filter losses were only considered in the spurious frequency bands and the authorized band was not corrected for High Pass Filter losses.  
 7. Proper operation of the transmitter prior to adding the filter to the measurement chain.



**HARMONICS AND SPURIOUS EMISSIONS (LOW CHANNEL, VERTICAL)**

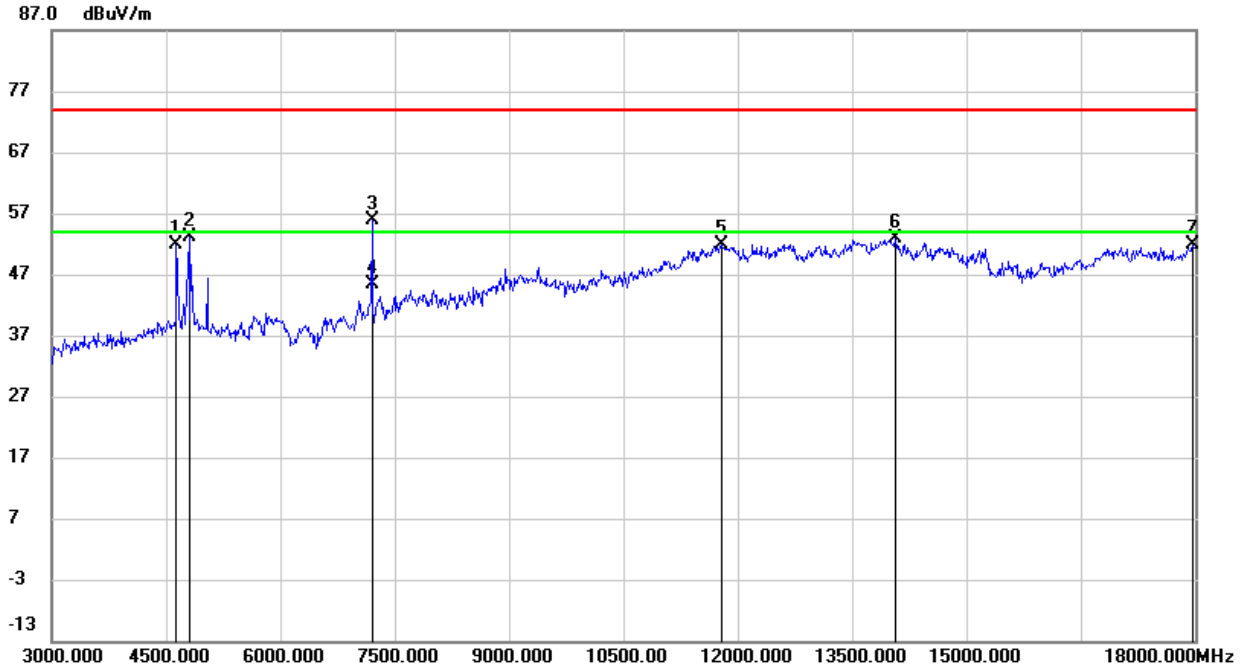

No.	Frequency (MHz)	Reading (dBuV)	Correct (dB/m)	Result (dBuV/m)	Limit (dBuV/m)	Margin (dB)	Remark
1	4635.000	53.34	-1.52	51.82	74.00	-22.18	peak
2	4800.000	54.09	-0.88	53.21	74.00	-20.79	peak
3	7200.000	50.08	5.75	55.83	74.00	-18.17	peak
4	7200.000	39.51	5.75	45.26	54.00	-8.74	AVG
5	11790.000	35.60	16.40	52.00	74.00	-22.00	peak
6	14070.000	31.97	20.79	52.76	74.00	-21.24	peak
7	17970.000	27.34	24.44	51.78	74.00	-22.22	peak

- Note: 1. Peak Result = Reading Level + Correct Factor.  
 2. If Peak Result complies with AV limit, AV Result is deemed to comply with AV limit.  
 3. Peak: Peak detector.  
 4. AVG:  $VBW=1/Ton$ , where: Ton is the transmitting duration.  
 5. For the transmitting duration, please refer to clause 7.1.  
 6. Filter losses were only considered in the spurious frequency bands and the authorized band was not corrected for High Pass Filter losses.  
 7. Proper operation of the transmitter prior to adding the filter to the measurement chain.

**HARMONICS AND SPURIOUS EMISSIONS (MID CHANNEL, HORIZONTAL)**

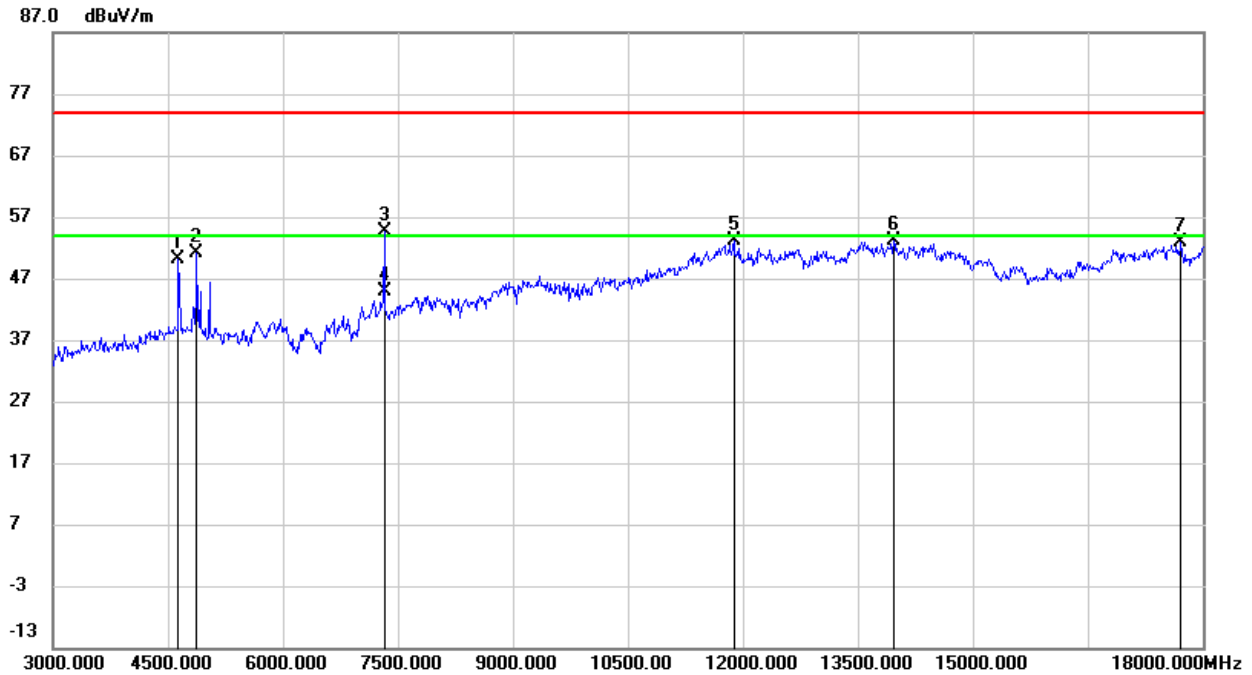

No.	Frequency (MHz)	Reading (dBuV)	Correct (dB/m)	Result (dBuV/m)	Limit (dBuV/m)	Margin (dB)	Remark
1	4635.000	51.65	-1.52	50.13	74.00	-23.87	peak
2	4875.000	51.62	-0.58	51.04	74.00	-22.96	peak
3	7320.000	48.98	5.69	54.67	74.00	-19.33	peak
4	7320.000	39.23	5.69	44.92	54.00	-9.08	AVG
5	11880.000	36.57	16.66	53.23	74.00	-20.77	peak
6	13965.000	32.13	20.99	53.12	74.00	-20.88	peak
7	17715.000	29.91	22.89	52.80	74.00	-21.20	peak

- Note: 1. Peak Result = Reading Level + Correct Factor.  
 2. If Peak Result complies with AV limit, AV Result is deemed to comply with AV limit.  
 3. Peak: Peak detector.  
 4. AVG:  $VBW=1/Ton$ , where: Ton is the transmitting duration.  
 5. For the transmitting duration, please refer to clause 7.1.  
 6. Filter losses were only considered in the spurious frequency bands and the authorized band was not corrected for High Pass Filter losses.  
 7. Proper operation of the transmitter prior to adding the filter to the measurement chain.



**HARMONICS AND SPURIOUS EMISSIONS (MID CHANNEL, VERTICAL)**

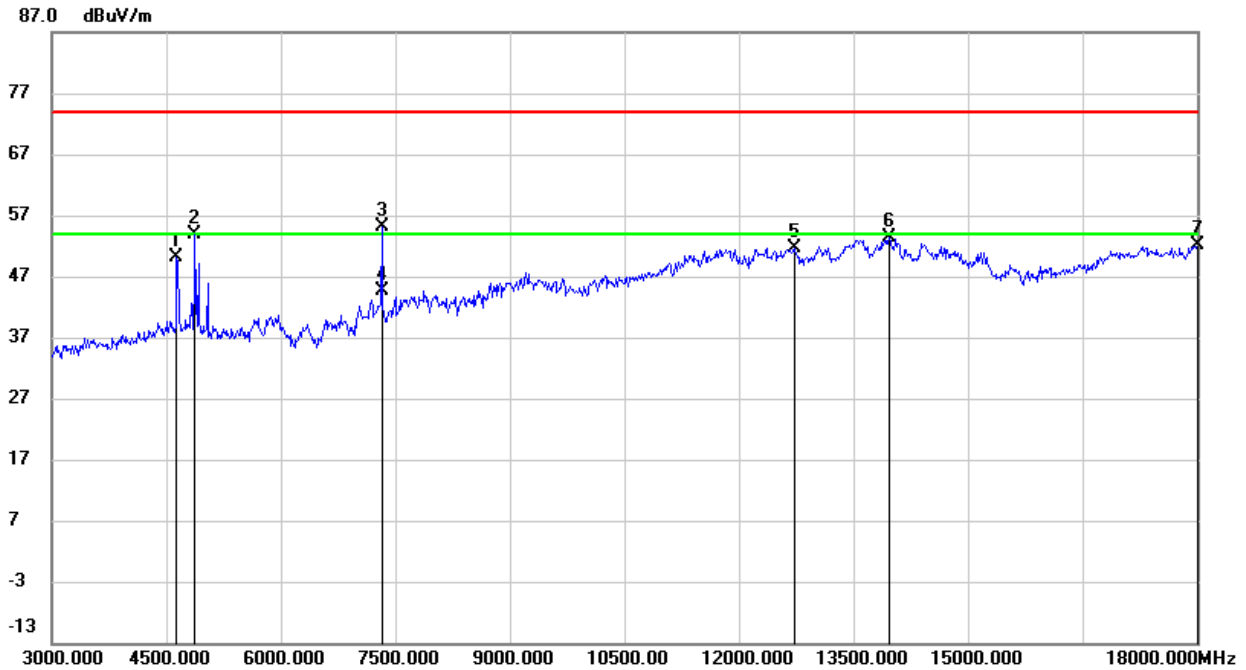

No.	Frequency (MHz)	Reading (dBuV)	Correct (dB/m)	Result (dBuV/m)	Limit (dBuV/m)	Margin (dB)	Remark
1	4635.000	51.69	-1.52	50.17	74.00	-23.83	peak
2	4875.000	54.41	-0.58	53.83	74.00	-20.17	peak
3	7320.000	49.32	5.69	55.01	74.00	-18.99	peak
4	7320.000	39.06	5.69	44.75	54.00	-9.25	AVG
5	12720.000	34.36	17.34	51.70	74.00	-22.30	peak
6	13965.000	32.38	20.99	53.37	74.00	-20.63	peak
7	18000.000	27.59	24.62	52.21	74.00	-21.79	peak

- Note: 1. Peak Result = Reading Level + Correct Factor.  
 2. If Peak Result complies with AV limit, AV Result is deemed to comply with AV limit.  
 3. Peak: Peak detector.  
 4. AVG:  $VBW=1/Ton$ , where: Ton is the transmitting duration.  
 5. For the transmitting duration, please refer to clause 7.1.  
 6. Filter losses were only considered in the spurious frequency bands and the authorized band was not corrected for High Pass Filter losses.  
 7. Proper operation of the transmitter prior to adding the filter to the measurement chain.



**HARMONICS AND SPURIOUS EMISSIONS (HIGH CHANNEL, HORIZONTAL)**

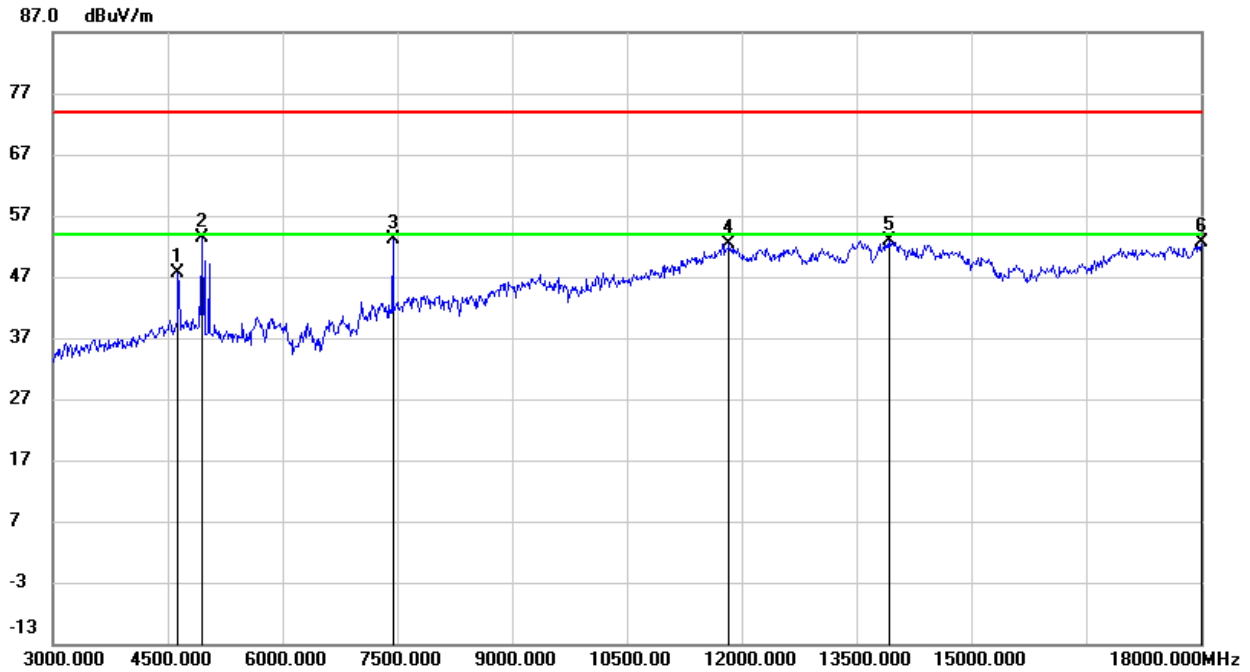

No.	Frequency (MHz)	Reading (dBuV)	Correct (dB/m)	Result (dBuV/m)	Limit (dBuV/m)	Margin (dB)	Remark
1	4635.000	49.24	-1.52	47.72	74.00	-26.28	peak
2	4950.000	53.74	-0.29	53.45	74.00	-20.55	peak
3	7440.000	47.51	5.65	53.16	74.00	-20.84	peak
4	11835.000	35.91	16.53	52.44	74.00	-21.56	peak
5	13920.000	32.07	20.87	52.94	74.00	-21.06	peak
6	18000.000	27.92	24.62	52.54	74.00	-21.46	peak

- Note: 1. Peak Result = Reading Level + Correct Factor.  
 2. If Peak Result complies with AV limit, AV Result is deemed to comply with AV limit.  
 3. Peak: Peak detector.  
 4. AVG:  $VBW=1/Ton$ , where: Ton is the transmitting duration.  
 5. For the transmitting duration, please refer to clause 7.1.  
 6. Filter losses were only considered in the spurious frequency bands and the authorized band was not corrected for High Pass Filter losses.  
 7. Proper operation of the transmitter prior to adding the filter to the measurement chain.



**HARMONICS AND SPURIOUS EMISSIONS (HIGH CHANNEL, VERTICAL)**

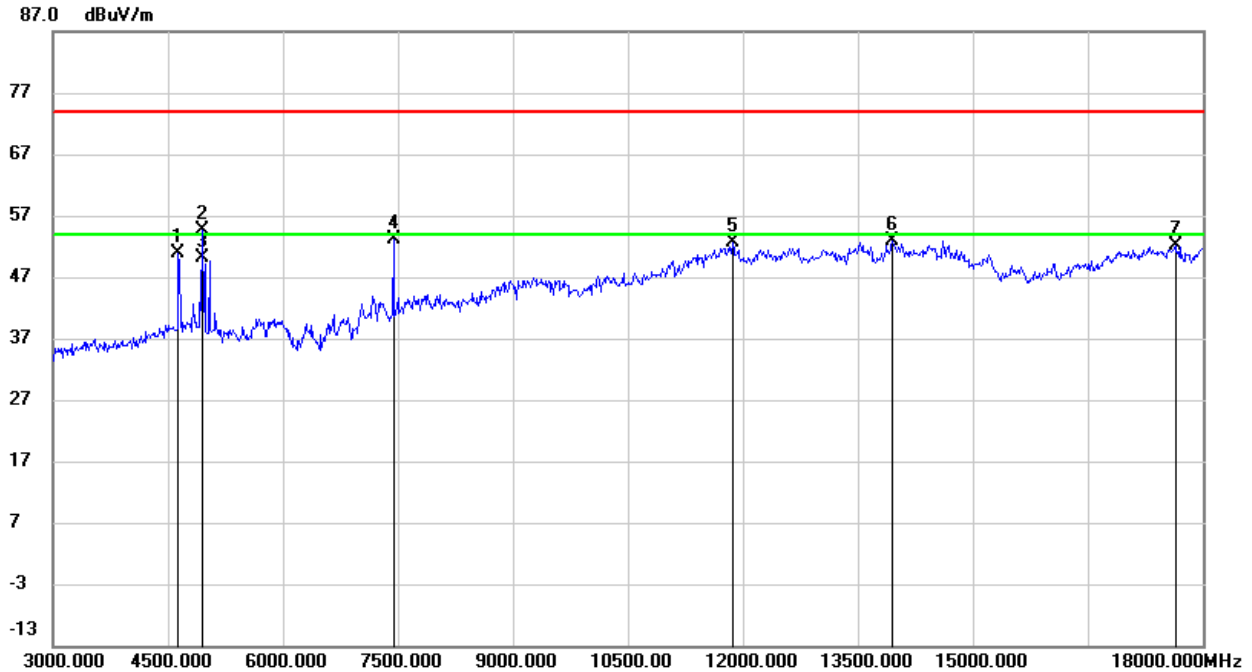

No.	Frequency (MHz)	Reading (dBuV)	Correct (dB/m)	Result (dBuV/m)	Limit (dBuV/m)	Margin (dB)	Remark
1	4635.000	52.47	-1.52	50.95	74.00	-23.05	peak
2	4950.000	54.98	-0.29	54.69	74.00	-19.31	peak
3	4950.000	50.52	-0.29	50.23	54.00	-3.77	AVG
4	7440.000	47.56	5.65	53.21	74.00	-20.79	peak
5	11865.000	35.94	16.61	52.55	74.00	-21.45	peak
6	13950.000	31.87	20.96	52.83	74.00	-21.17	peak
7	17640.000	29.71	22.44	52.15	74.00	-21.85	peak

- Note: 1. Peak Result = Reading Level + Correct Factor.  
 2. If Peak Result complies with AV limit, AV Result is deemed to comply with AV limit.  
 3. Peak: Peak detector.  
 4. AVG: VBW=1/Ton, where: Ton is the transmitting duration.  
 5. For the transmitting duration, please refer to clause 7.1.  
 6. Filter losses were only considered in the spurious frequency bands and the authorized band was not corrected for High Pass Filter losses.  
 7. Proper operation of the transmitter prior to adding the filter to the measurement chain.



## 8.4. SPURIOUS EMISSIONS (18 GHz ~ 26 GHz)

### 8.4.1. BLE\_1M MODE

#### SPURIOUS EMISSIONS (HIGHT CHANNEL, WORST-CASE CONFIGURATION, HORIZONTAL)

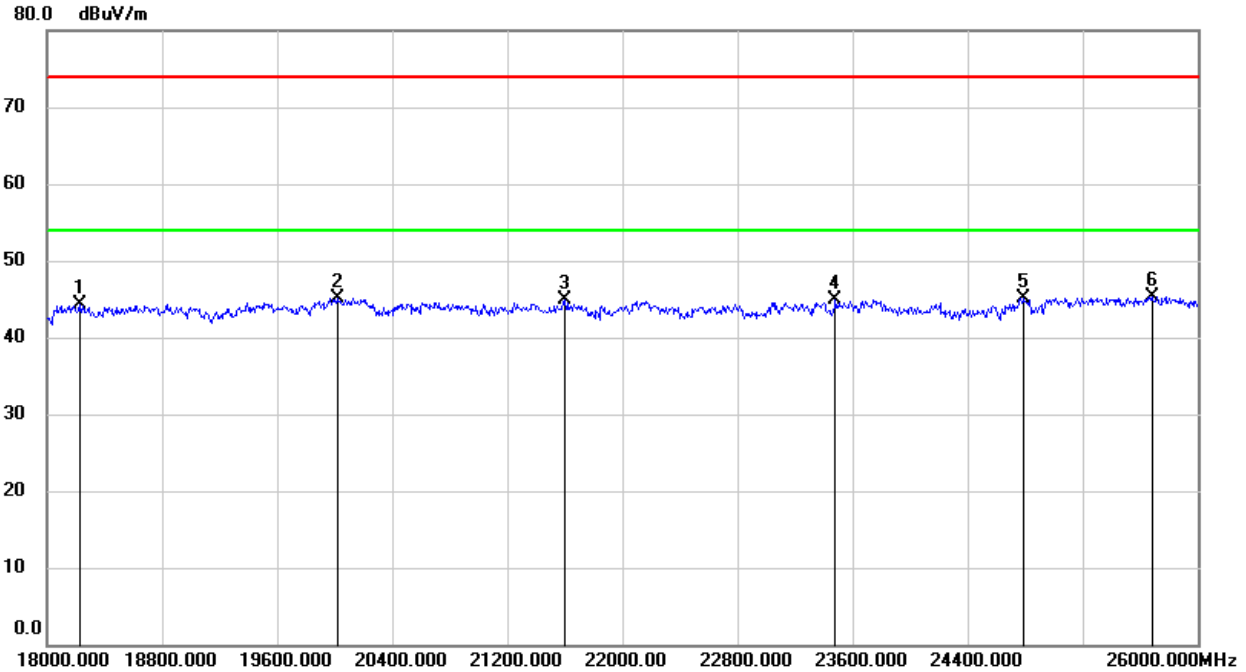

No.	Frequency (MHz)	Reading (dBuV)	Correct (dB/m)	Result (dBuV/m)	Limit (dBuV/m)	Margin (dB)	Remark
1	18224.000	49.77	-5.53	44.24	74.00	-29.76	peak
2	20016.000	50.56	-5.47	45.09	74.00	-28.91	peak
3	21600.000	49.52	-4.54	44.98	74.00	-29.02	peak
4	23480.000	48.04	-3.16	44.88	74.00	-29.12	peak
5	24792.000	47.48	-2.28	45.20	74.00	-28.80	peak
6	25680.000	46.21	-0.93	45.28	74.00	-28.72	peak

Note: 1. Peak Result = Reading Level + Correct Factor.

2. If Peak Result complies with AV limit, AV Result is deemed to comply with AV limit.

3. Peak: Peak detector.

**SPURIOUS EMISSIONS (HIGHT CHANNEL, WORST-CASE CONFIGURATION, VERTICAL)**

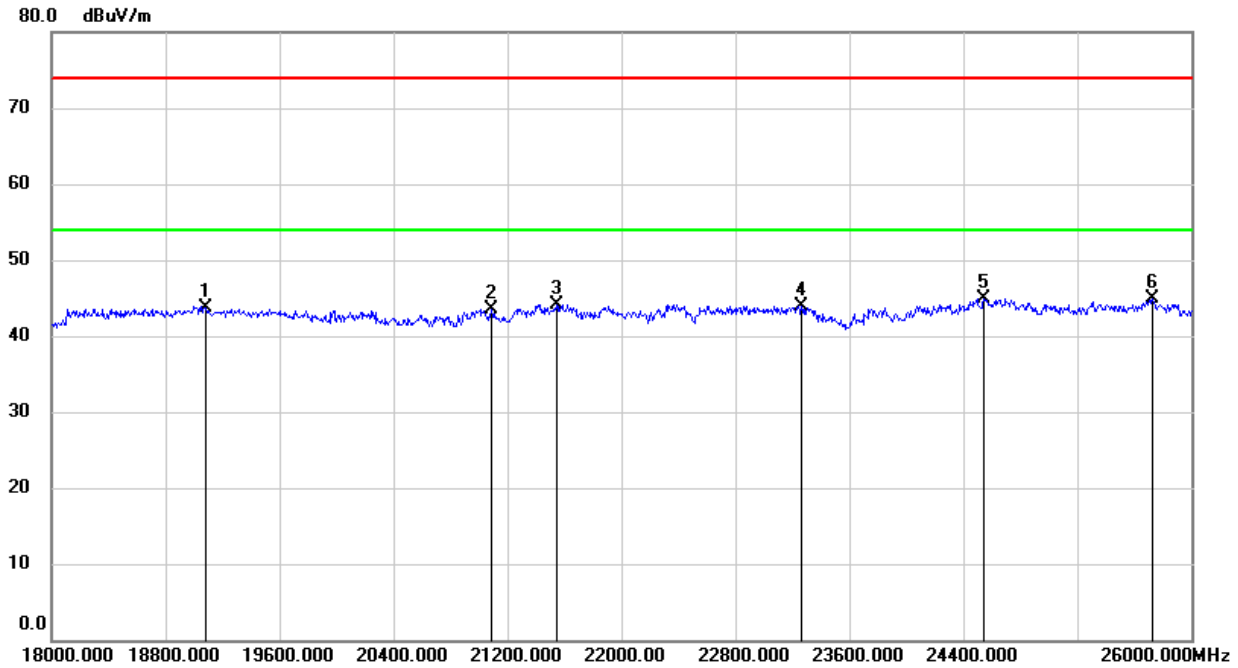

No.	Frequency (MHz)	Reading (dBuV)	Correct (dB/m)	Result (dBuV/m)	Limit (dBuV/m)	Margin (dB)	Remark
1	19080.000	49.10	-5.34	43.76	74.00	-30.24	peak
2	21088.000	48.28	-4.84	43.44	74.00	-30.56	peak
3	21544.000	48.76	-4.63	44.13	74.00	-29.87	peak
4	23264.000	47.26	-3.36	43.90	74.00	-30.10	peak
5	24544.000	47.19	-2.32	44.87	74.00	-29.13	peak
6	25728.000	45.61	-0.72	44.89	74.00	-29.11	peak

- Note: 1. Peak Result = Reading Level + Correct Factor.  
 2. If Peak Result complies with AV limit, AV Result is deemed to comply with AV limit.  
 3. Peak: Peak detector.

Note: All the modes have been tested, only the worst data was recorded in the report.

## 8.5. SPURIOUS EMISSIONS (30 MHz ~ 1 GHz)

### 8.5.1. BLE\_1M MODE

#### SPURIOUS EMISSIONS (HIGHT CHANNEL, WORST-CASE CONFIGURATION, HORIZONTAL)

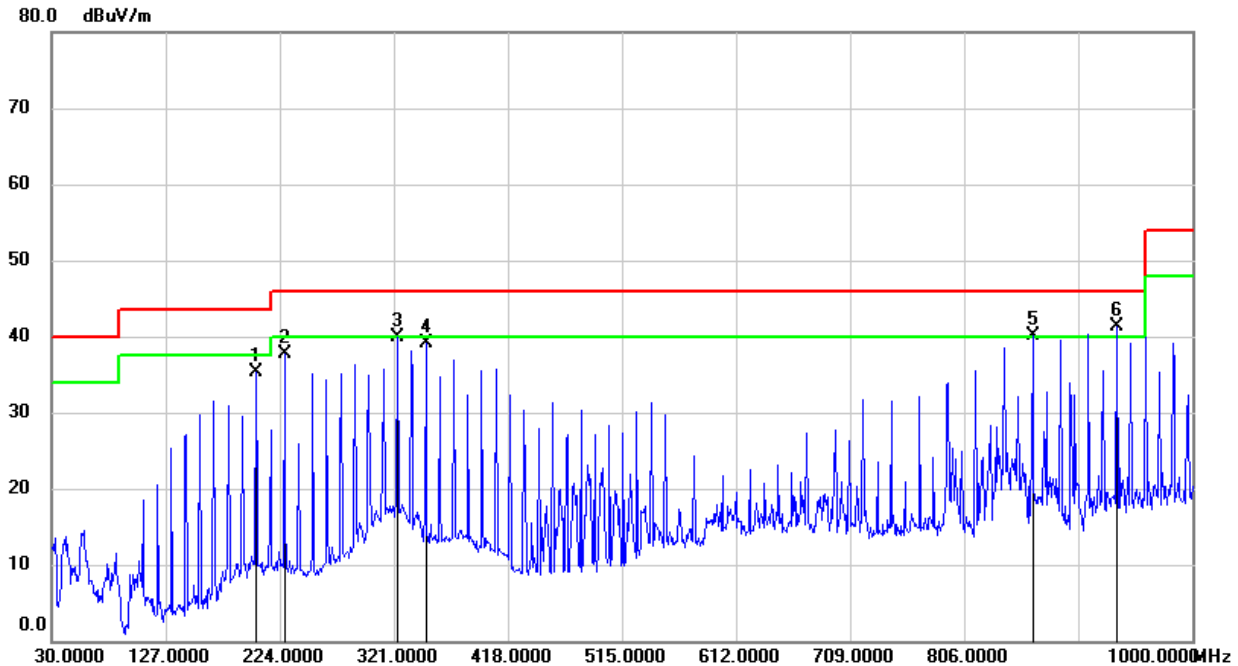

No.	Frequency (MHz)	Reading (dBuV)	Correct (dB/m)	Result (dBuV/m)	Limit (dBuV/m)	Margin (dB)	Remark
1	203.6300	51.93	-16.70	35.23	43.50	-8.27	QP
2	227.8800	56.30	-18.55	37.75	46.00	-8.25	QP
3	323.9100	54.63	-14.74	39.89	46.00	-6.11	QP
4	348.1600	53.51	-14.34	39.17	46.00	-6.83	QP
5	864.2000	46.07	-5.89	40.18	46.00	-5.82	QP
6	935.9800	45.93	-4.61	41.32	46.00	-4.68	QP

- Note: 1. Result Level = Read Level + Correct Factor.  
 2. If Peak Result complies with QP limit, QP Result is deemed to comply with QP limit.  
 3. Test setup: RBW: 120 kHz, VBW: 300 kHz, Sweep time: auto.

**SPURIOUS EMISSIONS (HIGHT CHANNEL, WORST-CASE CONFIGURATION, VERTICAL)**

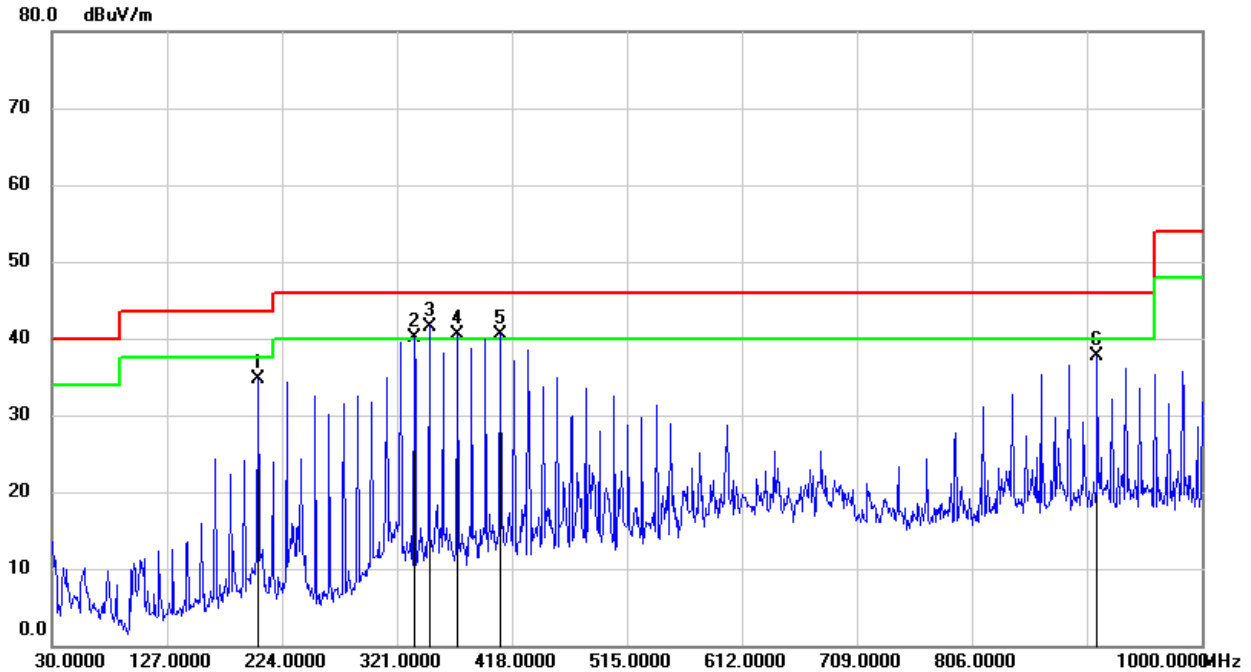

No.	Frequency (MHz)	Reading (dBuV)	Correct (dB/m)	Result (dBuV/m)	Limit (dBuV/m)	Margin (dB)	Remark
1	203.6300	51.49	-16.70	34.79	43.50	-8.71	QP
2	335.5500	54.67	-14.54	40.13	46.00	-5.87	QP
3	348.1600	55.94	-14.34	41.60	46.00	-4.40	QP
4	372.4100	54.29	-13.87	40.42	46.00	-5.58	QP
5	408.3000	53.76	-13.17	40.59	46.00	-5.41	QP
6	911.7300	42.73	-4.93	37.80	46.00	-8.20	QP

- Note: 1. Result Level = Read Level + Correct Factor.  
 2. If Peak Result complies with QP limit, QP Result is deemed to comply with QP limit.  
 3. Test setup: RBW: 120 kHz, VBW: 300 kHz, Sweep time: auto

Note: All the modes have been tested, only the worst data was recorded in the report.

## 8.6. SPURIOUS EMISSIONS BELOW 30 MHz

### 8.6.1. BLE\_1M MODE

**SPURIOUS EMISSIONS (HIGHT CHANNEL, LOOP ANTENNA FACE ON TO THE EUT, WORST-CASE CONFIGURATION)**

**9 kHz ~ 150 kHz**

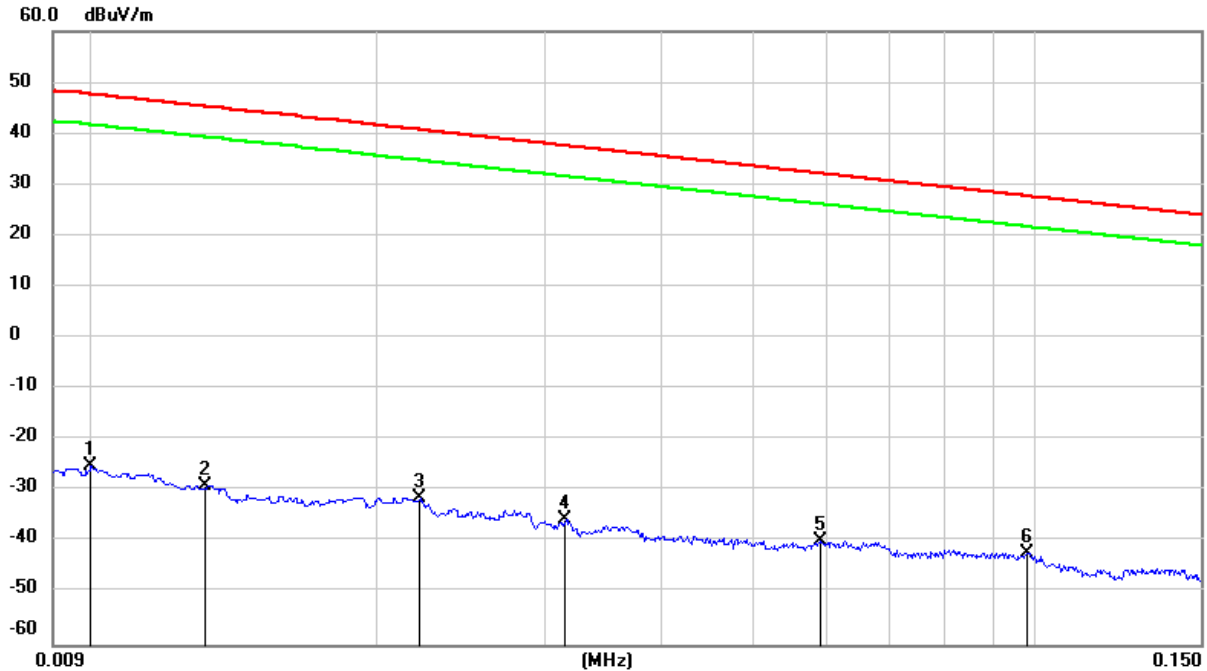

No.	Frequency (MHz)	Reading (dBuV)	Correct (dB/m)	FCC Result (dBuV/m)	ISED Result (dBuA/m)	FCC Limit (dBuV/m)	ISED Limit (dBuA/m)	Margin (dB)	Remark
1	0.01	76.22	-101.4	-25.18	-76.68	47.6	-3.9	-72.78	peak
2	0.0131	72.47	-101.38	-28.91	-80.41	45.25	-6.25	-74.16	peak
3	0.0221	70.13	-101.35	-31.22	-82.72	40.71	-10.79	-71.93	peak
4	0.0316	65.74	-101.4	-35.66	-87.16	37.61	-13.89	-73.27	peak
5	0.0589	61.81	-101.52	-39.71	-91.21	32.2	-19.3	-71.91	peak
6	0.0981	59.77	-101.78	-42.01	-93.51	27.77	-23.73	-69.78	peak

Note: 1. Measurement = Reading Level + Correct Factor (dBuA/m= dBuV/m- 20Log10[120π] = dBuV/m- 51.5).

2. If Peak Result complies with AV and QP limit, AV and QP Result are deemed to comply with AV limit.

3. All 3 polarizations (Horizontal, Face-on and Face-off) of the loop antenna had been tested, but only the worst data recorded in the report.

**150 kHz ~ 490 kHz**

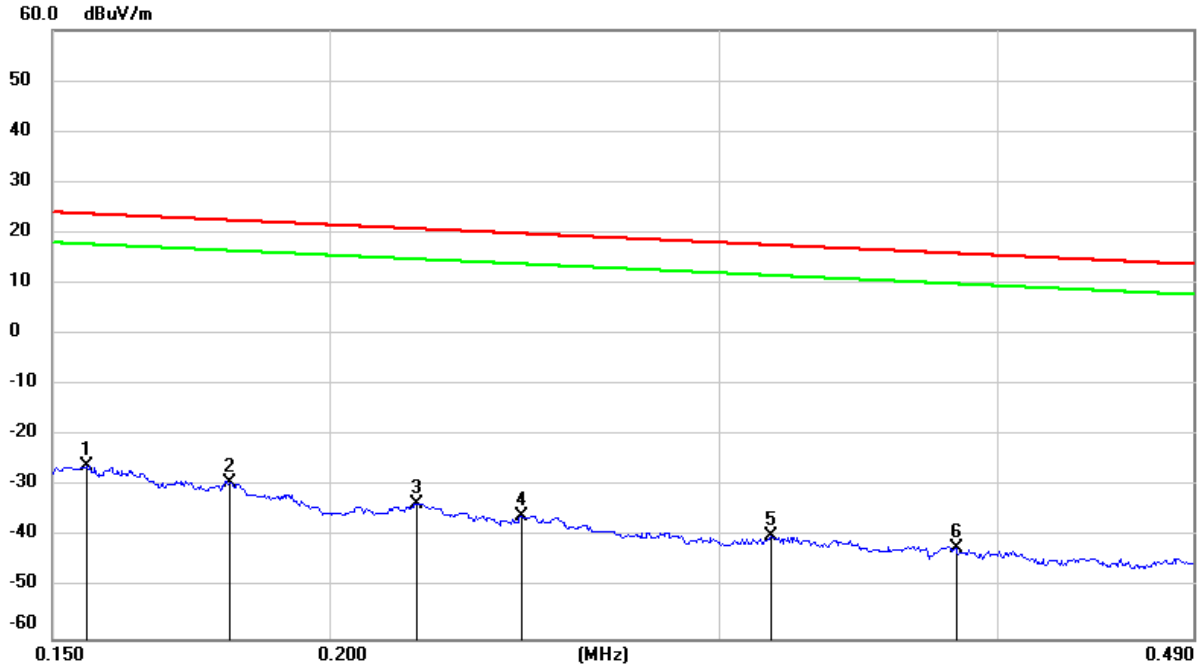

No.	Frequency (MHz)	Reading (dBuV)	Correct (dB/m)	FCC Result (dBuV/m)	ISED Result (dBuA/m)	FCC Limit (dBuV/m)	ISED Limit (dBuA/m)	Margin (dB)	Remark
1	0.1554	75.77	-101.65	-25.88	-77.38	23.77	-27.73	-49.65	peak
2	0.1801	72.53	-101.68	-29.15	-80.65	22.5	-29	-51.65	peak
3	0.219	68.27	-101.75	-33.48	-84.98	20.79	-30.71	-54.27	peak
4	0.2442	66.03	-101.79	-35.76	-87.26	19.85	-31.65	-55.61	peak
5	0.3163	62.2	-101.87	-39.67	-91.17	17.6	-33.9	-57.27	peak
6	0.383	59.7	-101.94	-42.24	-93.74	15.94	-35.56	-58.18	peak

Note: 1. Measurement = Reading Level + Correct Factor (dBuA/m= dBuV/m- 20Log10[120π] = dBuV/m- 51.5).

2. If Peak Result complies with AV and QP limit, AV and QP Result are deemed to comply with AV limit.

3. All 3 polarizations (Horizontal, Face-on and Face-off) of the loop antenna had been tested, but only the worst data recorded in the report.

**490 kHz ~ 30 MHz**

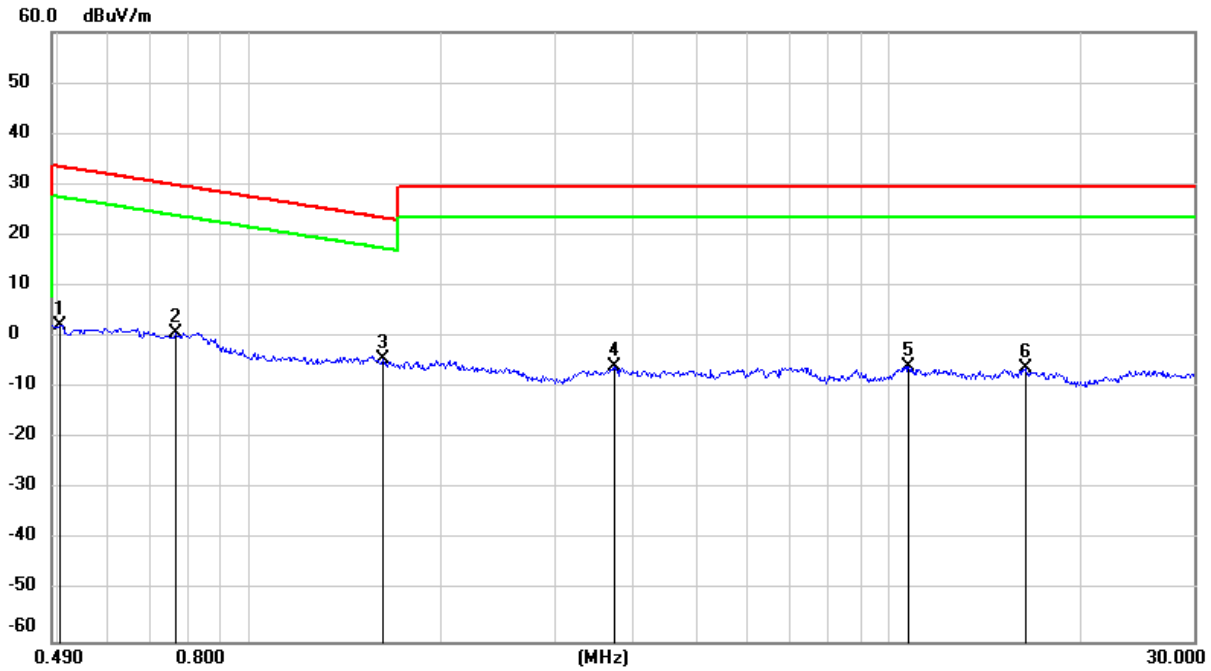

No.	Frequency (MHz)	Reading (dBuV)	Correct (dB/m)	FCC Result (dBuV/m)	ISED Result (dBuA/m)	FCC Limit (dBuV/m)	ISED Limit (dBuA/m)	Margin (dB)	Remark
1	0.5039	64.43	-62.07	2.36	-49.14	33.56	-17.94	-31.20	peak
2	0.7641	62.92	-62.12	0.8	-50.70	29.94	-21.56	-29.14	peak
3	1.6149	57.62	-62	-4.38	-55.88	23.44	-28.06	-27.82	peak
4	3.71	55.7	-61.41	-5.71	-57.21	29.54	-21.96	-35.25	peak
5	10.7299	54.98	-60.83	-5.85	-57.35	29.54	-21.96	-35.39	peak
6	16.3959	54.67	-60.96	-6.29	-57.79	29.54	-21.96	-35.83	peak

Note: 1. Measurement = Reading Level + Correct Factor (dBuA/m= dBuV/m- 20Log10[120π] = dBuV/m- 51.5).

2. If Peak Result complies with AV and QP limit, AV and QP Result are deemed to comply with AV limit.

3. All 3 polarizations (Horizontal, Face-on and Face-off) of the loop antenna had been tested, but only the worst data recorded in the report.

Note: All the modes have been tested, only the worst data was recorded in the report.



## 9. ANTENNA REQUIREMENTS

### APPLICABLE REQUIREMENTS

Please refer to FCC §15.203

An intentional radiator shall be designed to ensure that no antenna other than that furnished by the responsible party shall be used with the device. The use of a permanently attached antenna or of an antenna that uses a unique coupling to the intentional radiator shall be considered sufficient to comply with the provisions of this section. The manufacturer may design the unit so that a broken antenna can be replaced by the user, but the use of a standard antenna jack or electrical connector is prohibited.

Please refer to FCC §15.247(b)(4)

The conducted output power limit specified in paragraph (b) of this section is based on the use of antennas with directional gains that do not exceed 6 dBi. Except as shown in paragraph (c) of this section, if transmitting antennas of directional gain greater than 6 dBi are used, the conducted output power from the intentional radiator shall be reduced below the stated values in paragraphs (b)(1), (b)(2), and (b)(3) of this section, as appropriate, by the amount in dB that the directional gain of the antenna exceeds 6 dBi.

### RESULTS

Complies





## 10. Appendix

### 10.1. Appendix A: DTS Bandwidth

#### 10.1.1. Test Result

Test Mode	Antenna	Channel	DTS BW [MHz]	FL[MHz]	FH[MHz]	Limit[MHz]	Verdict
BLE_1M	Ant1	2402	0.71	2401.74	2402.45	0.5	PASS
		2440	0.72	2439.74	2440.45	0.5	PASS
		2480	0.72	2479.73	2480.45	0.5	PASS

### 10.1.2. Test Graphs

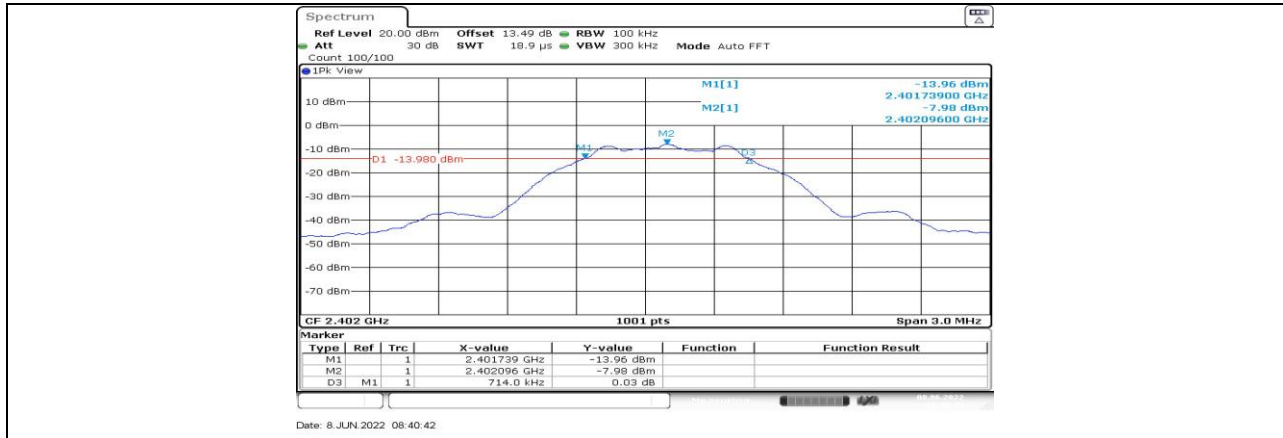

BLE\_1M\_Ant1\_2402

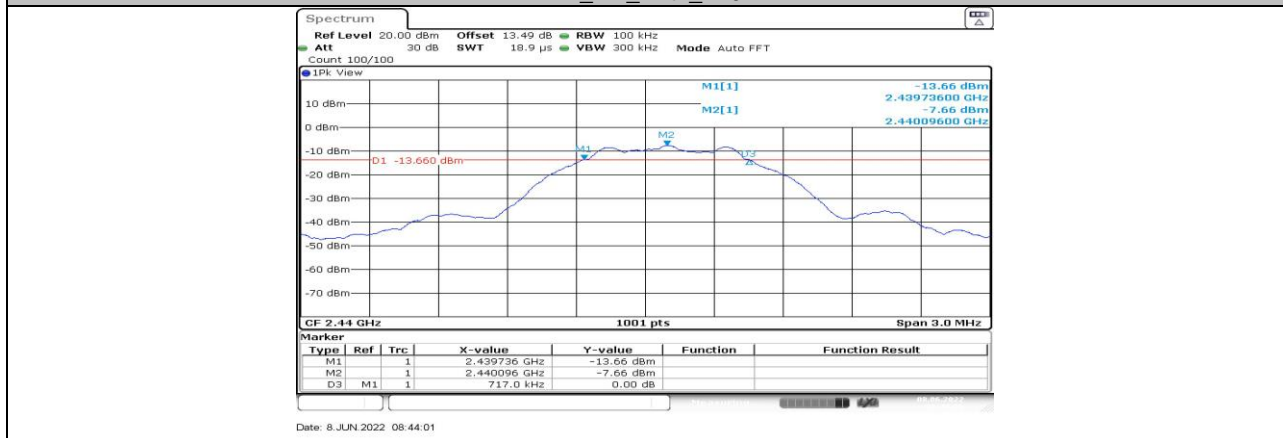

BLE\_1M\_Ant1\_2440

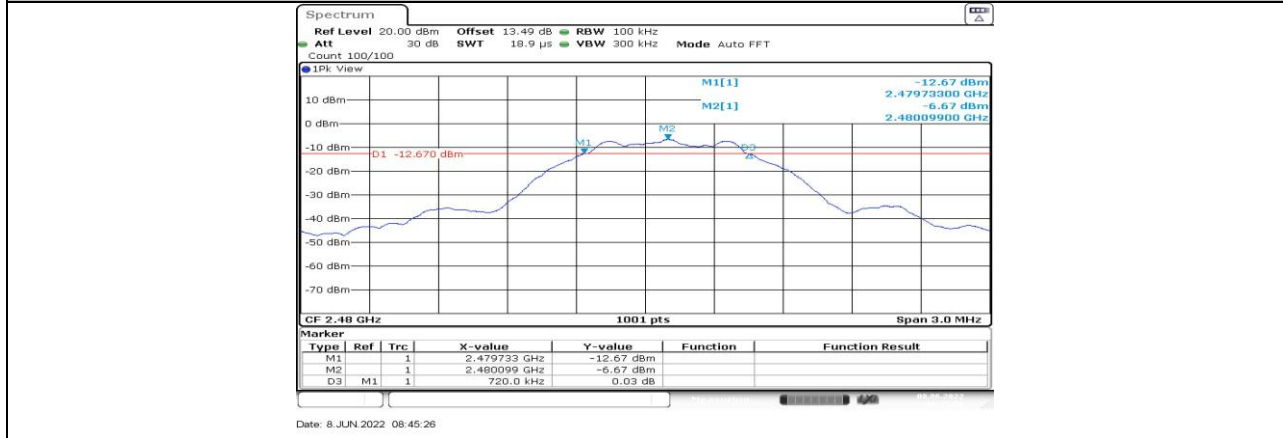

BLE\_1M\_Ant1\_2480



## 10.2. Appendix B: Occupied Channel Bandwidth

### 10.2.1. Test Result

Test Mode	Antenna	Channel	OCB [MHz]	FL[MHz]	FH[MHz]	Verdict
BLE_1M	Ant1	2402	1.059	2401.572	2402.631	PASS
		2440	1.063	2439.572	2440.635	PASS
		2480	1.063	2479.572	2480.635	PASS

### 10.2.2. Test Graphs

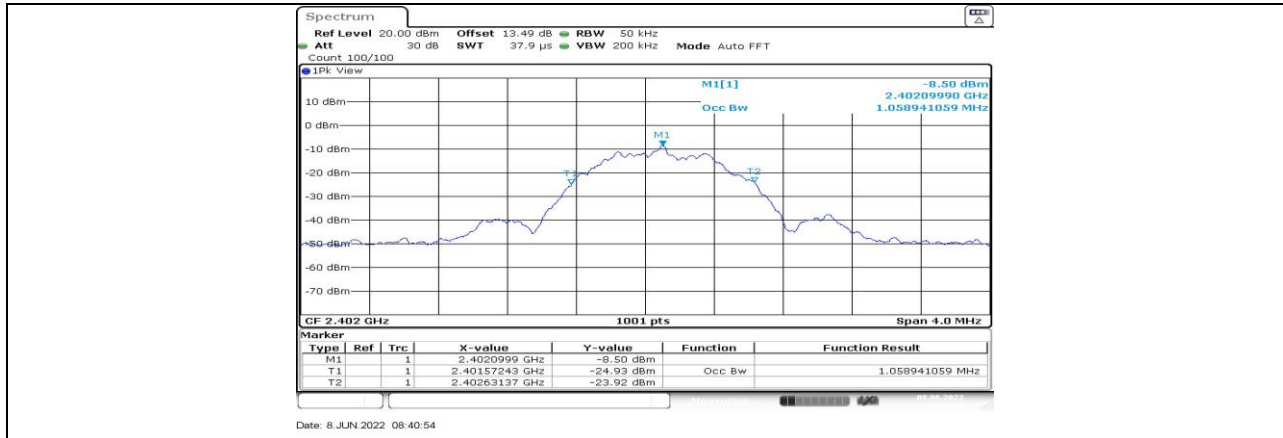

BLE\_1M\_Ant1\_2402

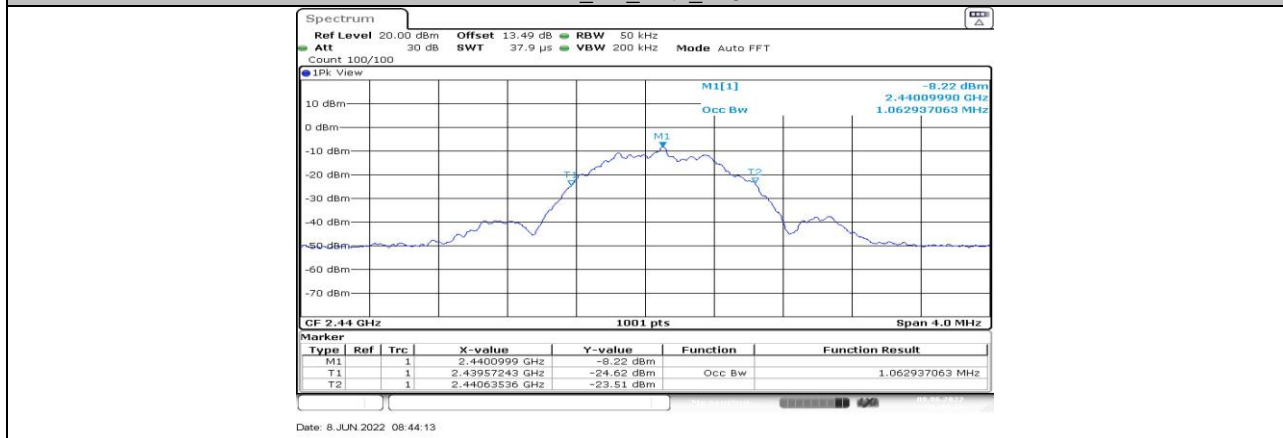

BLE\_1M\_Ant1\_2440

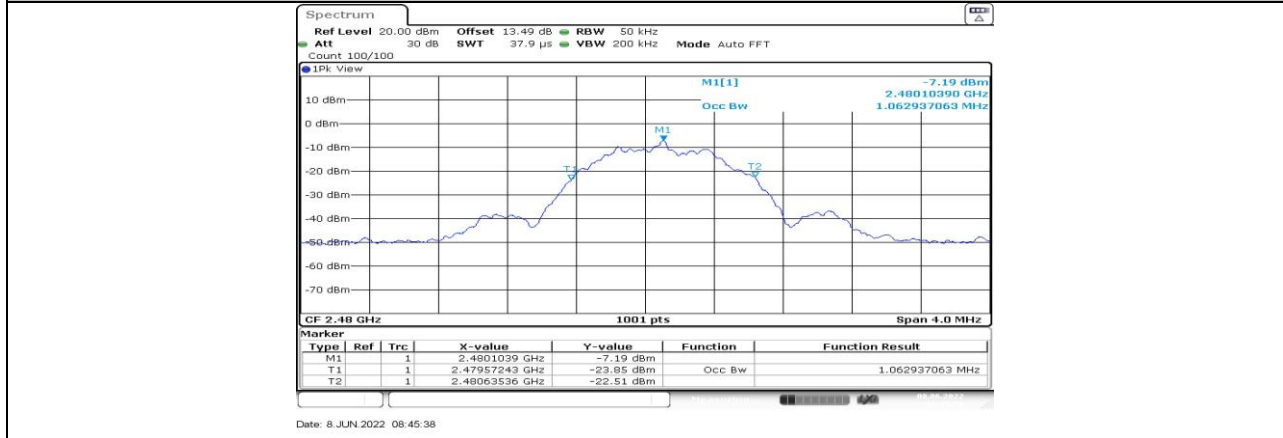

BLE\_1M\_Ant1\_2480



### 10.3. Appendix C: Maximum Peak Conducted Output Power

#### 10.3.1. Test Result

Test Mode	Antenna	Channel	Result[dBm]	Limit[dBm]	Verdict
BLE_1M	Ant1	2402	-7.54	≤30	PASS
		2440	-7.23	≤30	PASS
		2480	-6.27	≤30	PASS



## 10.4. Appendix D: Maximum Power Spectral Density

### 10.4.1. Test Result

Test Mode	Antenna	Channel	Result[dBm/3kHz]	Limit[dBm/3kHz]	Verdict
BLE_1M	Ant1	2402	-23.52	≤8.00	PASS
		2440	-23.21	≤8.00	PASS
		2480	-22.33	≤8.00	PASS

### 10.4.2. Test Graphs

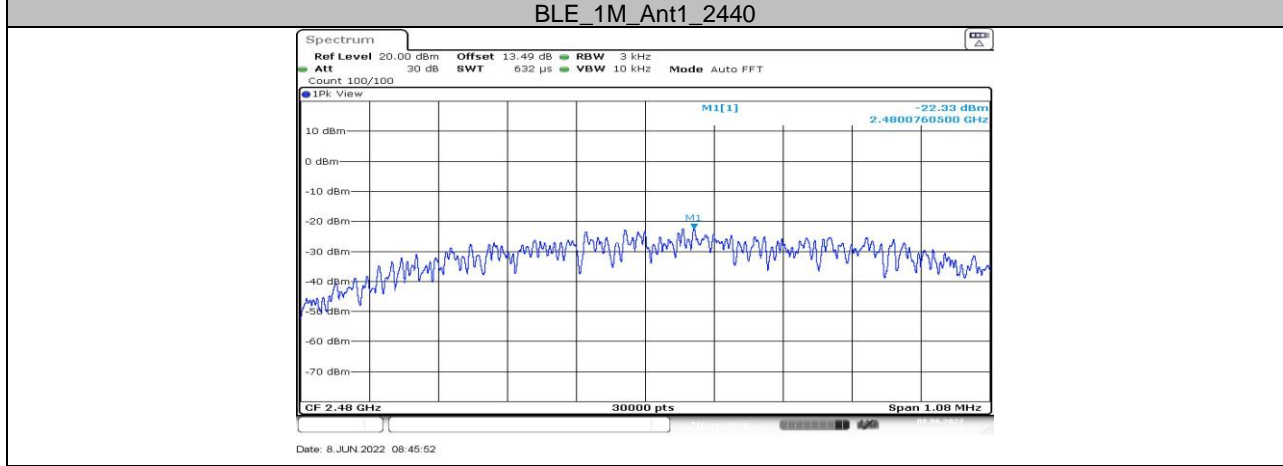
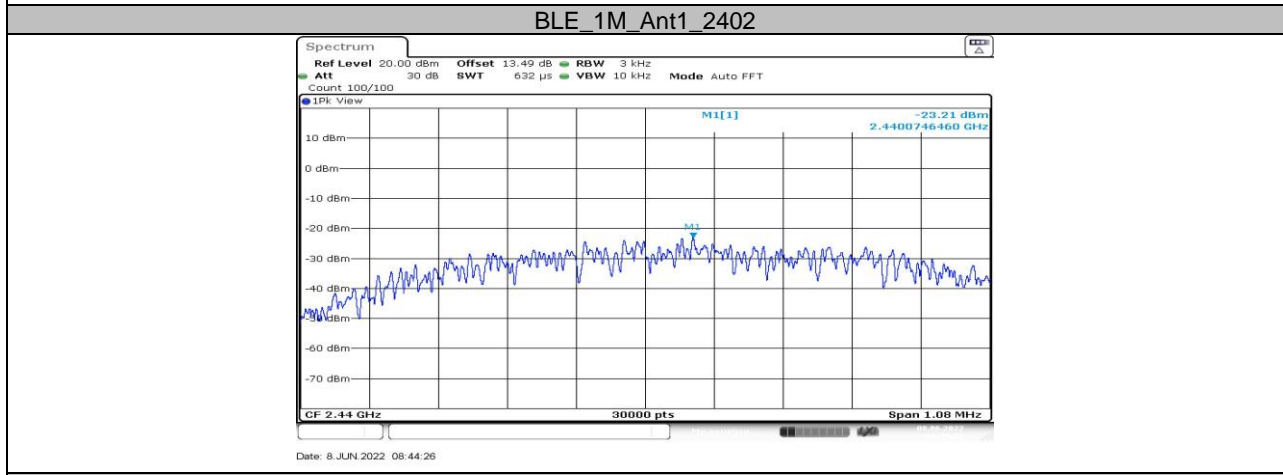
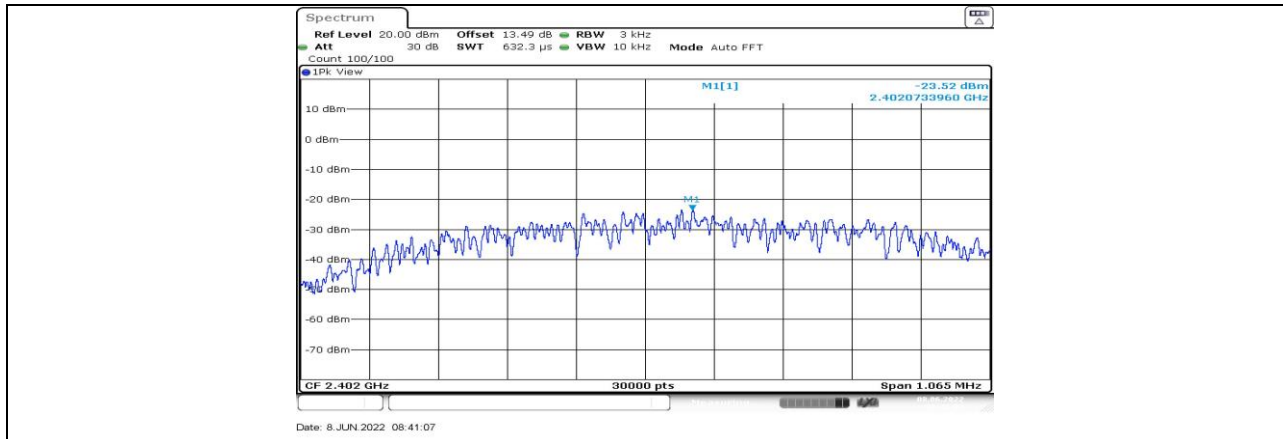



## 10.5. Appendix E: Band Edge Measurements

### 10.5.1. Test Result

Test Mode	Antenna	ChName	Channel	RefLevel[dBm]	Result[dBm]	Limit[dBm]	Verdict
BLE_1M	Ant1	Low	2402	-8.01	-45.2	$\leq -28.01$	PASS
		High	2480	-6.76	-43.81	$\leq -26.76$	PASS



### 10.5.2. Test Graphs

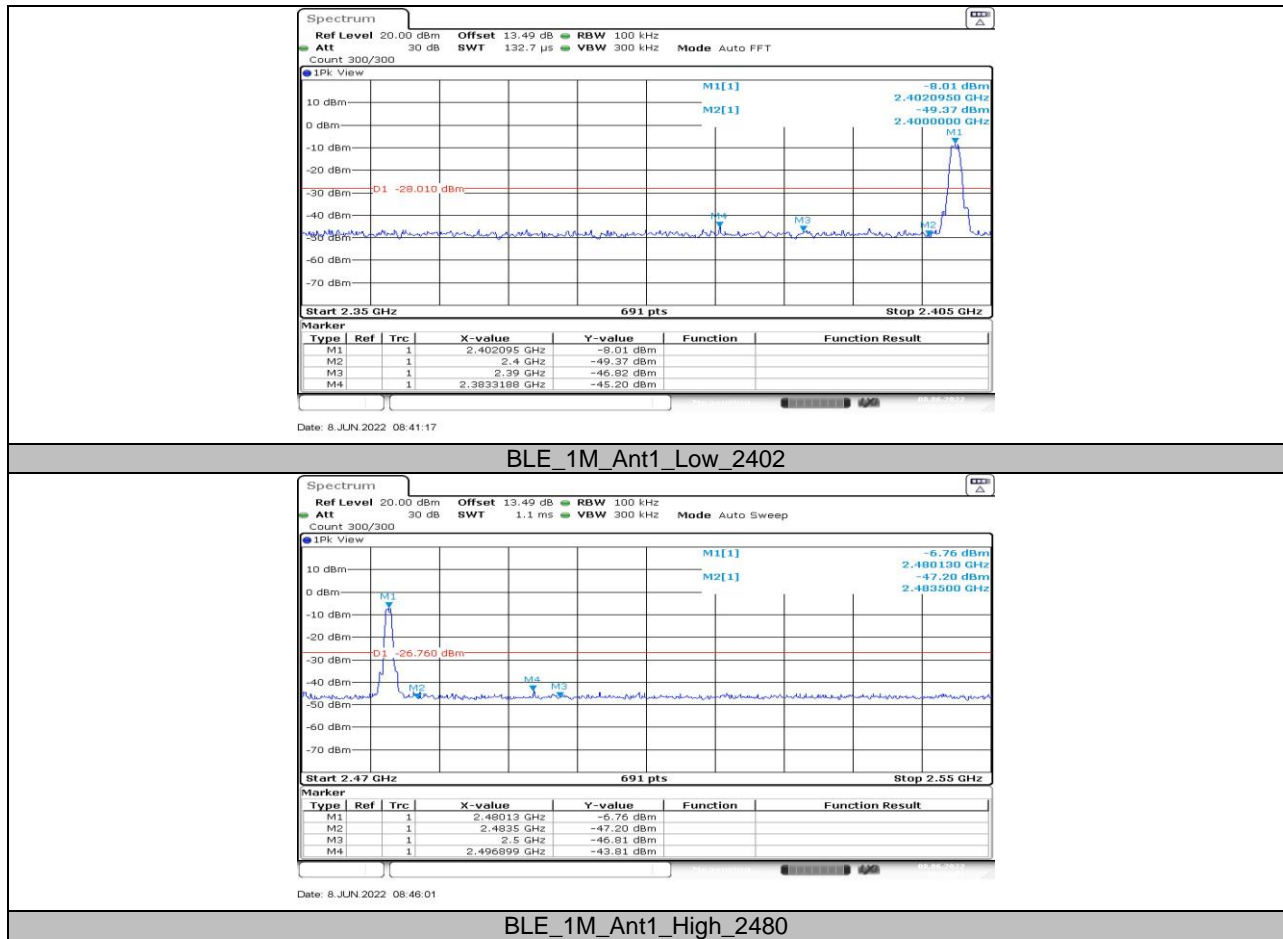



## 10.6. Appendix F: Conducted Spurious Emission

### 10.6.1. Test Result

Test Mode	Antenna	Channel	FreqRange [MHz]	Result[dBm]	Limit[dBm]	Verdict
BLE_1M	Ant1	2402	Reference	-7.97	---	PASS
			30~1000	-54.07	$\leq -27.97$	PASS
			1000~26500	-45.35	$\leq -27.97$	PASS
		2440	Reference	-7.69	---	PASS
			30~1000	-54.53	$\leq -27.69$	PASS
			1000~26500	-44.27	$\leq -27.69$	PASS
		2480	Reference	-6.68	---	PASS
			30~1000	-54.69	$\leq -26.68$	PASS
			1000~26500	-45.96	$\leq -26.68$	PASS

### 10.6.2. Test Graphs

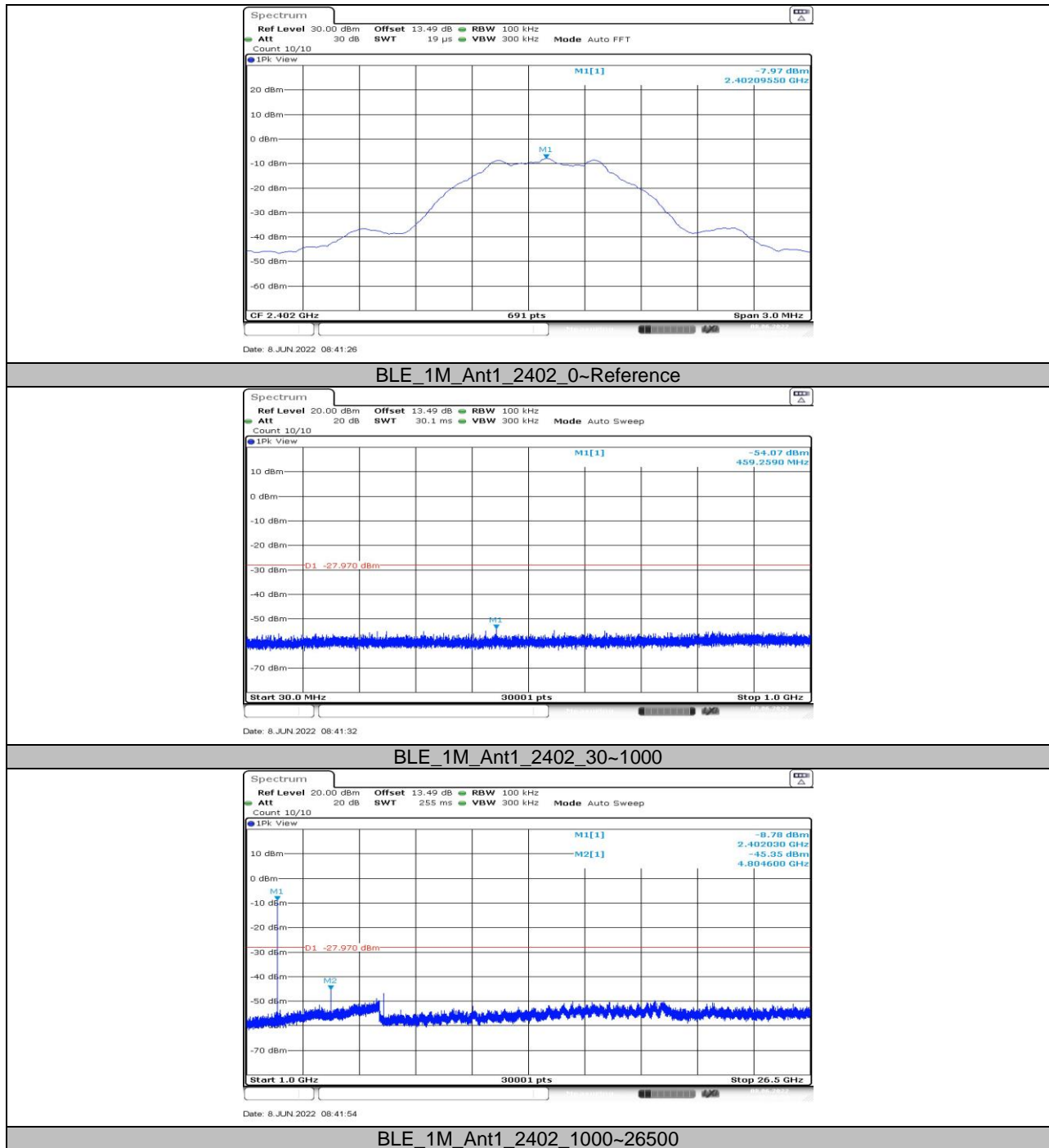



BLE\_1M\_Ant1\_2440\_0~Reference

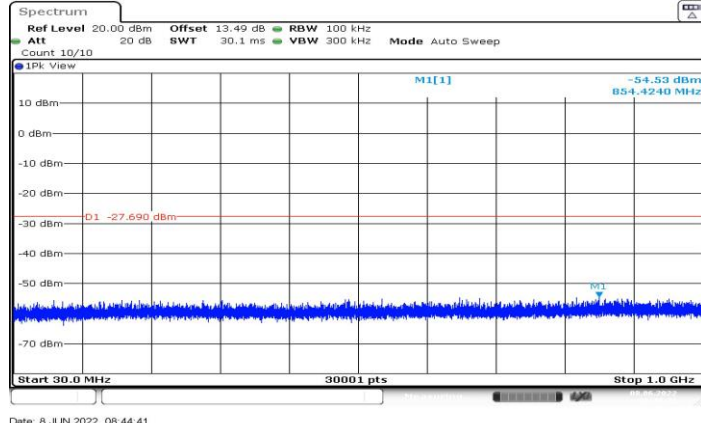

BLE\_1M\_Ant1\_2440\_30~1000

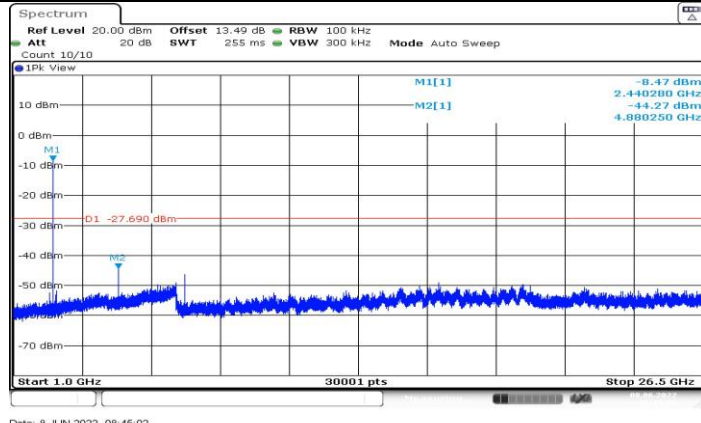

BLE\_1M\_Ant1\_2440\_1000~26500

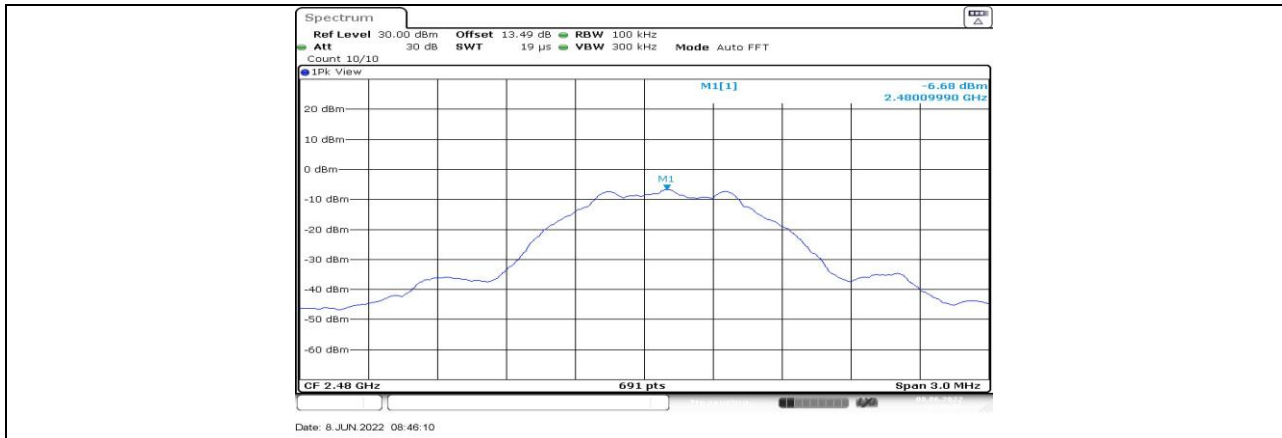

BLE\_1M\_Ant1\_2480\_0~Reference

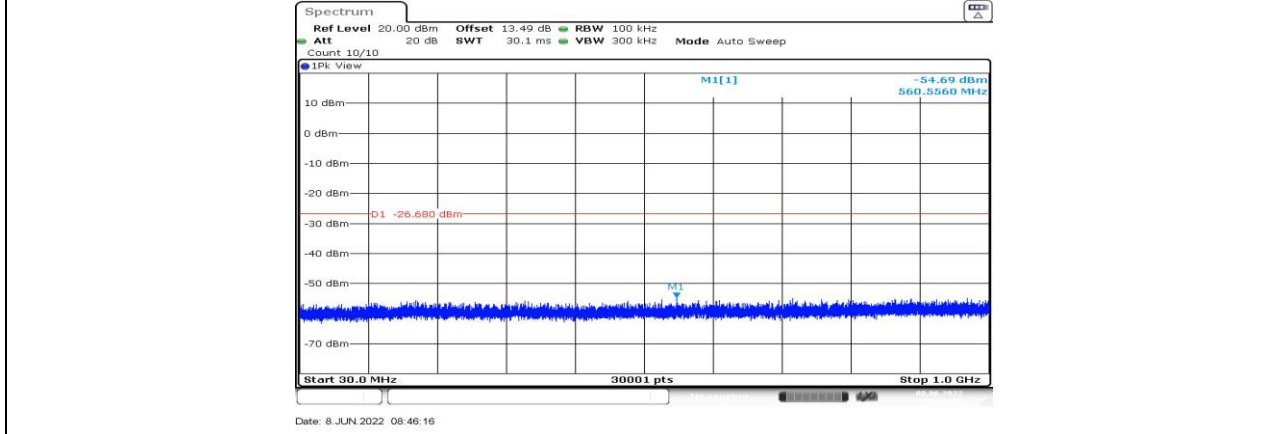

BLE\_1M\_Ant1\_2480\_30~1000

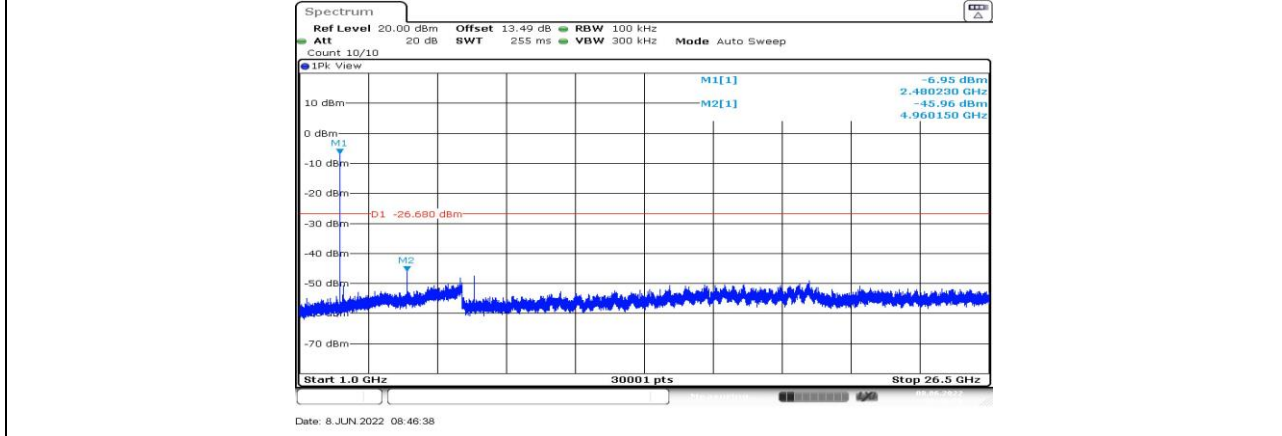

BLE\_1M\_Ant1\_2480\_1000~26500



## 10.7. Appendix G: Duty Cycle

### 10.7.1. Test Result

Test Mode	On Time (msec)	Period (msec)	Duty Cycle x (Linear)	Duty Cycle (%)	Duty Cycle Correction Factor (dB)	1/T Minimum VBW (kHz)	Final setting For VBW (kHz)
BLE_1M	0.39	0.61	0.6393	63.93	1.94	2.56	3

Note:

Duty Cycle Correction Factor= $10\log(1/x)$ .

Where: x is Duty Cycle (Linear)

Where: T is On Time

If that calculated VBW is not available on the analyzer then the next higher value should be used.

### 10.7.2. Test Graphs

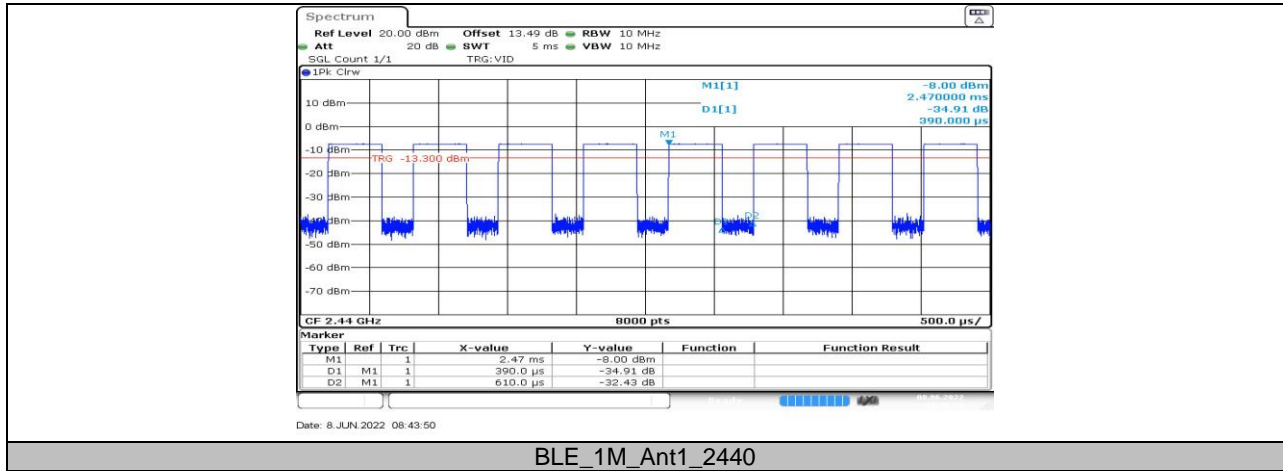

**END OF REPORT**