







FCC CERTIFICATION TEST REPORT

Applicant:	SOUND AROUND INC.
Address:	1600, 63 RD STREET, BROOKLYNNEW YORK, 11204 China
Manufacturer:	SOUND AROUND INC.
Address:	1600,63 RD STREET, BROOKLYNNEW YORK,11204 China
Product Description:	PLUTO
Brand Name:	SQUATZ
Tested Model:	SQPLUTO
FCC ID:	2A5X5-SQPLUTO
Additional Models:	/
Report No.:	JCF220823202-003
Received Date:	Aug.23,2022
Tested Date:	Aug.23,2022~Sep.08,2022
Issued Date:	Sep.08,2022
Test Standards:	FCC Rules and Regulations Part 15 Subpart C,
Test Procedure :	ANSI C63.10:2013
Test Result:	Pass
Prepared By:	
 	
Roger Li/Engineer	
Reviewed By:	
 	
Jone Lv/Engineer	
Approved By:	
 	
Talent Zhang/Engineer	
Date: Sep.08,2022	

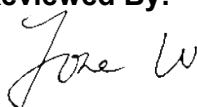
Note: The test results in this report apply exclusively to the tested model / sample. Without written approval of Guangzhou Jingce Testing Technology Co., Ltd. the test report shall not be reproduced except in full.

Report Revise Record

Report Version	Revise Time	Issued Date	Valid Version	Notes
V1.0	/	Sep.08,2022	Original Report	/

Table of Contents

1. Test Report Declare	5
2. Summary of Test Results	6
3. Test Laboratory	6
4. Equipment Under Test	7
4.1. Description of EUT	7
4.2. Channel List	7
4.3. Test Channel Configuration	8
4.4. Test environment conditions	8
4.5. Description of Available Antennas	8
4.6. Description of Available Antennas	9
5. Description of Test Setup	9
5.1. Accessory	9
5.2. Support Equipment	9
5.3. Test Setup	10
5.4. Setup Diagram for Tests	10
6. Measurement Uncertainty	10
7. Measuring Instrument and Software Used	10
8. On Time and Duty Cycle	12
8.1. Block diagram of test setup	12
8.2. Limits	12
8.3. Procedure	12
8.4. Results	12
8.5. Original test data	13
9. 6 dB DTS Bandwidth and 99 % Occupied Bandwidth	18
9.1. Block diagram of test setup	18
9.2. Limits	18
9.3. Test Procedure	18
9.4. Results	19
9.5. Original test data	20
10. Conducted Output Power	25
10.1. Block diagram of test setup	25
10.2. Limits	25
10.3. Test Procedure	25
10.4. Results	25
11. Power Spectral Density	26
11.1. Block diagram of test setup	26
11.2. Limits	26
11.3. Test Procedure	26
11.4. Results	26
11.5. Original test data	27
12. Conducted Band edge and Spurious Emissions	32
12.1. Block diagram of test setup	32
12.2. Limits	32
12.3. Test Procedure	32
12.4. Test result	33

12.5. Original test data	34
13. Radiated Emission	52
13.1. Block diagram of test setup	52
13.2. Limit	53
13.3. Test Procedure	55
13.4. Results	58
13.5. Original test data	58
14. AC Power Line Conducted Emissions	59
14.1. Block diagram of test setup	59
14.2. Limits	59
14.3. Test procedure	59
14.4. Test result	60
14.5. Original test data	60
15. Antenna Requirements	61
15.1. Applicable Requirements	61
15.2. Result	61
APPENDIX A – Radiated Emission Below 1GHz Test Data	62
APPENDIX B – Radiated Emission Above 1GHz Test Data	64
APPENDIX C – AC Power Line Conducted Emission Test Data	104

1. Test Report Declare

Applicant:	SOUND AROUND INC.
Address:	1600, 63 RD STREET, BROOKLYNNEW YORK, 11204 China
Manufacturer:	SOUND AROUND INC.
Address:	1600,63 RD STREET, BROOKLYNNEW YORK,11204 China
Product Name	PLUTO
Brand Name:	SQUATZ
Model Name:	SQPLUTO

We Declare:

The equipment described above is tested by Guangzhou Jingce Testing Technology Co., Ltd. and in the configuration tested the equipment complied with the standards specified above. The test results are contained in this test report and Guangzhou Jingce Testing Technology Co., Ltd. is assumed of full responsibility for the accuracy and completeness of these tests.

2. Summary of Test Results

Summary of Test Results			
Clause	Test Items	FCC Rules	Test Results
1	6dB Bandwidth and 99 % Occupied Bandwidth	FCC Part 15.247 (a) (2)	Pass
2	Peak Conducted Output Power	FCC Part 15.247 (b) (3)	Pass
3	Power Spectral Density	FCC Part 15.247 (e)	Pass
4	Conducted Bandedge and Spurious Emission	FCC Part 15.247 (d)	Pass
5	Radiated Bandedge and Spurious Emission	FCC Part 15.247 (d) FCC Part 15.209 FCC Part 15.205	Pass
6	Conducted Emission Test For AC Power Port	FCC Part 15.207	Pass
7	Antenna Requirement	FCC Part 15.203	Pass

3. Test Laboratory

Guangzhou Jingce Testing Technology Co., Ltd.

Add.: No.192, Kezhu Road, Huangpu District, Guangzhou, Guangdong, China

Association for Laboratory Accreditation(A2LA). Certificate Number: 6594.01

FCC Designation Number:CN1331. Test Firm Registration Number: 360543

IC Test Firm Registration Number: 28796

Conformity Assessment Body identifier: CN0138

4. Equipment Under Test

4.1. Description of EUT

EUT* Name:	PLUTO
Model Number:	SQPLUTO
EUT Function Description:	Please reference user manual of this device
Power Supply:	Input: 100-240V~,50/60Hz
Hardware Version:	YD.ESP32.1D
Software Version:	PC260_OS_22d023_20220818
Radio Specification:	IEEE802.11b/g/n
Operation Frequency:	IEEE 802.11b: 2412MHz—2462MHz IEEE 802.11g: 2412MHz—2462MHz IEEE 802.11n HT20, HT40: 2412MHz—2462MHz
Modulation:	IEEE 802.11b: DSSS (CCK, DQPSK, DBPSK) IEEE 802.11g: OFDM (64QAM, 16QAM, QPSK, BPSK) IEEE 802.11n (HT20/40): OFDM (64QAM, 16QAM, QPSK,BPSK)
Data Rate:	IEEE 802.11b: 1, 2, 5.5, 11 Mbps IEEE 802.11g: 6, 9, 12, 18, 24, 36, 48, 54 Mbps IEEE 802.11n HT20: 6.5, 13, 19.5, 26, 39, 52, 58.5, 65.5 Mbps IEEE 802.11n HT40: 13.5, 27, 40.5, 54, 81, 108, 121.5, 135 Mbps
Antenna Type:	FPC Antenna, 4.52 dBi

Note 1: EUT is the ab. of equipment under test.

Note 2: The antenna gain is declared by the customer and the laboratory is not responsible for the accuracy of the antenna gain.

4.2. Channel List

Channel	Frequency (MHz)	Channel	Frequency (MHz)	Channel	Frequency (MHz)
1	2412	5	2432	9	2452
2	2417	6	2437	10	2457
3	2422	7	2442	11	2462
4	2427	8	2447	/	/

Channel	Frequency (MHz)	Channel	Frequency(MHz)
3	2422	7	2442
4	2427	8	2447
5	2432	9	2452
6	2437	/	/

4.3. Test Channel Configuration

Tested mode, channel and rand data rate information			
Mode	Data rate (Mbps) (see Note)	Channel	Frequency (MHz)
IEEE 802.11b	1MHz	Low: CH1	2412
	1MHz	Middle: CH6	2437
	1MHz	High: CH11	2462
IEEE 802.11g	6 MHz	Low: CH1	2412
	6 MHz	Middle: CH6	2437
	6 MHz	High: CH11	2462
IEEE 802.11n HT20	MCS0	Low: CH1	2412
	MCS0	Middle: CH6	2437
	MCS0	High: CH11	2462
IEEE 802.11n HT40	MCS0	Low: CH3	2422
	MCS0	Middle: CH6	2437
	MCS0	High: CH9	2452

Note: According exploratory test, EUT will have maximum output power in those data rate, so those data rate were used for all test.

4.4. Test environment conditions

During the measurement the environmental conditions were within the listed ranges:

Temperature range:	21-25 °C
Humidity range:	40-75%
Pressure range:	86-106 kPa

4.5. Description of Available Antennas

The Worse Case Power Setting Parameter under 2400 ~ 2483.5MHz Band			
Test Software		ESP32 Test Tool	
Modulation Mode	Transmit Antenna Number	Test Software Setting Value	
		ANT1	Channel
802.11b	1	6	CH1
		6	CH6
		5	CH11
802.11g	1	0	CH1
		0	CH6
		0	CH11
802.11HT20	1	0	CH1
		0	CH6
		0	CH11
802.11n HT40	1	0	CH3
		0	CH6
		0	CH9

4.6. Description of Available Antennas

Test Mode	Transmit and Receive Mode	Description
IEEE 802.11b	<input checked="" type="checkbox"/> 1TX, 1RX	ANT 1 can be used as transmitting/receiving antenna.
IEEE 802.11g	<input checked="" type="checkbox"/> 1TX, 1RX	ANT 1 can be used as transmitting/receiving antenna.
IEEE 802.11n HT20	<input checked="" type="checkbox"/> 1TX, 1RX	ANT 1 can be used as transmitting/receiving antenna.
IEEE 802.11n HT40	<input checked="" type="checkbox"/> 1TX, 1RX	ANT 1 can be used as transmitting/receiving antenna.

5. Description of Test Setup

5.1. Accessory

Description of Accessories	Manufacturer	Model Number	Description	Remark
/	/	/	/	/

5.2. Support Equipment

Equipment	Brand Name	Model Name	P/N
PC	Lenovo	T480	/

5.3. Test Setup

The EUT can work in in fixed frequency mode.

5.4. Setup Diagram for Tests



6. Measurement Uncertainty

Where relevant, the following measurement uncertainty levels have been estimated for tests performed on the apparatus:

Test Item	Uncertainty
AC Power Conduction emission	1.37 dB
All Radiated emissions	5.4dB
Conducted emissions	3.09 dB
Occupied Channel Bandwidth	1.1%
Conducted Output power	0.82dB
Power Spectral Density	0.82dB

Note: This uncertainty represents an expanded uncertainty expressed at approximately the 95 % confidence level using a coverage factor of k = 2.

7. Measuring Instrument and Software Used

TS Test System						
Used	Equipment	Manufacturer	Model No.	Serial No.	Last Cal.	Due. Date
<input checked="" type="checkbox"/>	Spectrum Analyzer	Keysight	N9030B	MY56320512	Jul.25,2022	Jul.24,2023
<input checked="" type="checkbox"/>	Vector Signal Generator	Keysight	N5182B	MY57300334	Dec.03,2021	Dec.02,2022
<input checked="" type="checkbox"/>	Signal Generator	Keysight	N5171B	MY57280639	Dec.03,2021	Dec.02,2022
<input checked="" type="checkbox"/>	DC POWER	Keysight	E342A	MY59020356	Jul.25,2022	Jul.24,2023
<input checked="" type="checkbox"/>	Incubator thermometer	GWS	EL-02JA	21107288	Nov.05,2021	Nov.04,2022
<input checked="" type="checkbox"/>	Control unit(Power sensor)	Tonscend	JS0806-2	/	Jul.25,2022	Jul.24,2023
Software						
Used	Description	Manufacturer	Name	Version		
<input checked="" type="checkbox"/>	Test software	TS+	JS1120-3	V3.2.11		
RSE Test System						
Used	Equipment	Manufacturer	Model No.	Serial No.	Last Cal.	Due. Date
<input checked="" type="checkbox"/>	EMI Receiver	R&S	ESW	101685	Jul.24,2022	Jul.23,2023

<input checked="" type="checkbox"/>	Bilog Antenna	Schwarzbeck	VULB 9163	01416	Feb.22,2022	Feb.21,2023
<input checked="" type="checkbox"/>	Horn Antenna 1	Schwarzbeck	BBHA 9120 D	02411	May.30,2022	May.29,2023
<input checked="" type="checkbox"/>	Horn Antenna 2	ETS	3116C	00217677	Aug.27,2022	Aug.26,2023
<input checked="" type="checkbox"/>	Signal Pre-Amplifier	Tonscend	TAP01018050	AP21C806122	Aug.08,2022	Aug.07,2023
<input checked="" type="checkbox"/>	Signal Pre-Amplifier	Tonscend	TAP9K3G32	AP20K806104	Aug.08,2022	Aug.07,2023
<input checked="" type="checkbox"/>	Signal Pre-Amplifier	ETS	3116C-PA	00217677	Sep.29,2021	Sep.28,2022
<input checked="" type="checkbox"/>	Wideband radio communication tester	R&S	CMW500	163478	Jul.25,2022	Jul.24,2023
<input checked="" type="checkbox"/>	3m Fully-anechoic Chamber	ETS	RFD-100	/	Apr.24,2021	Apr.23,2024
Software						
Used	Description	Manufacturer	Name		Version	
<input checked="" type="checkbox"/>	Test software	TS+	TS+		V3.0.0.4	
Conducted Emission Test For AC Power Port						
Used	Equipment	Manufacturer	Model No.	Serial No.	Last Cal.	Due. Date
<input checked="" type="checkbox"/>	LISN	R&S	ENV216	102154	Jul.24,2022	Jul.23,2023
<input checked="" type="checkbox"/>	EMI Receiver	R&S	ESR3	102509	Jul.24,2022	Jul.23,2023
Software						
Used	Description	Manufacturer	Name		Version	
<input checked="" type="checkbox"/>	Test software	EZ	EZ-EMC		EMEC-3A1	
Other Instrument						
Used	Equipment	Manufacturer	Model No.	Serial No.	Last Cal.	Due. Date
<input checked="" type="checkbox"/>	Temperature & Humidity	Temperature	HTC-1	/	Jan.24,2022	Jan.23,2023

8. On Time and Duty Cycle

8.1. Block diagram of test setup

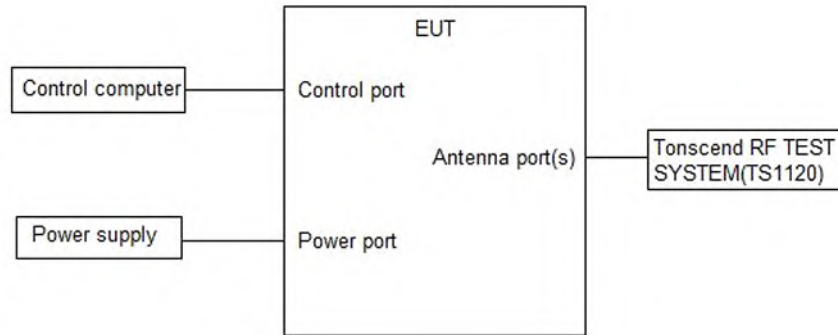

8.2. Limits

None; for reporting purposes only

8.3. Procedure

KDB 558074 Zero-Span Spectrum Analyzer Method

8.4. Results

Test Mode	Ant.	Freq. [MHz]	Transmission Duration [ms]	Transmission Period [ms]	Duty Cycle [%]
11B	Ant1	2412	20.00	20.00	100.00
		2437	20.00	20.00	100.00
		2462	20.00	20.00	100.00
11G	Ant1	2412	20.00	20.00	100.00
		2437	20.00	20.00	100.00
		2462	20.00	20.00	100.00
11N20SISO	Ant1	2412	20.00	20.00	100.00
		2437	20.00	20.00	100.00
		2462	20.00	20.00	100.00
11N40SISO	Ant1	2422	20.00	20.00	100.00
		2437	20.00	20.00	100.00
		2452	20.00	20.00	100.00

Note: Duty Cycle Correction Factor = $10\log(1/x)$.

Where: x is Duty Cycle (Linear)

If that calculated VBW is not available on the analyzer, then the next higher value should be used.

For mode 11b, the duty cycle is greater than 98 %, so it can set VBW to 10 Hz.

8.5. Original test data



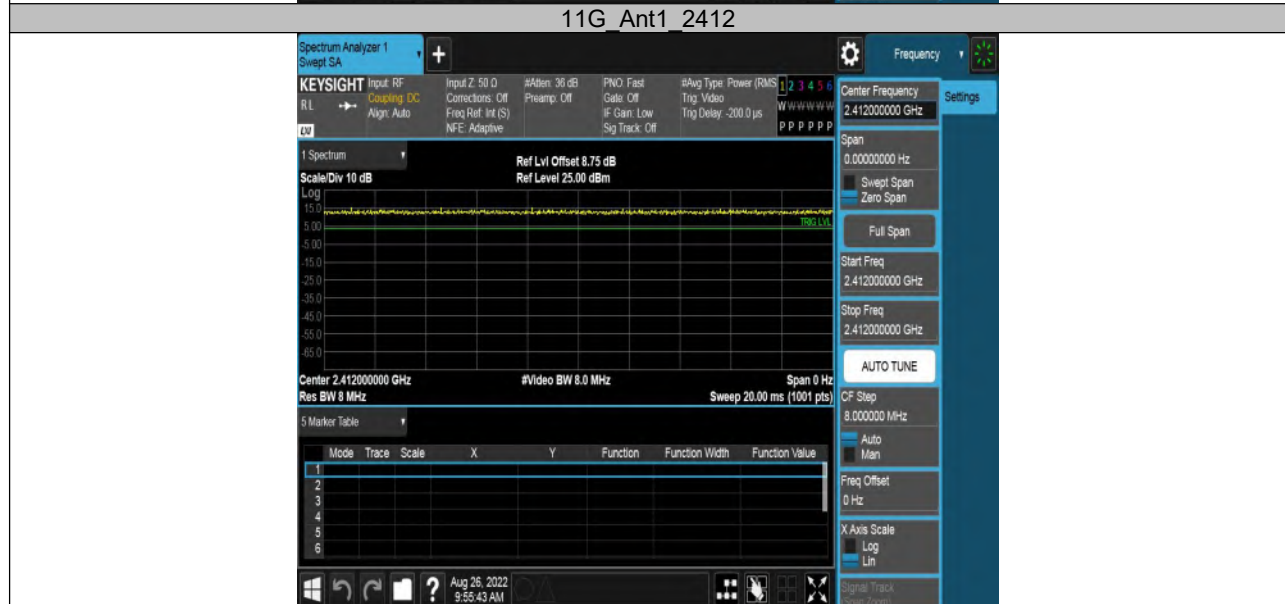

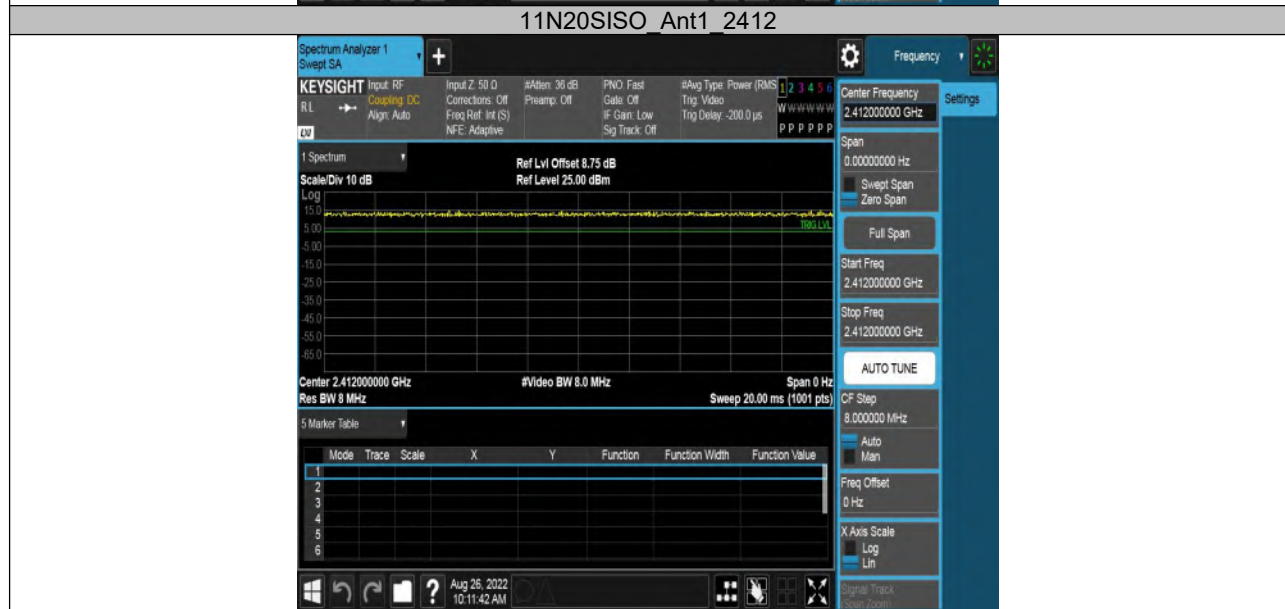

11N20SISO_Ant1_2437

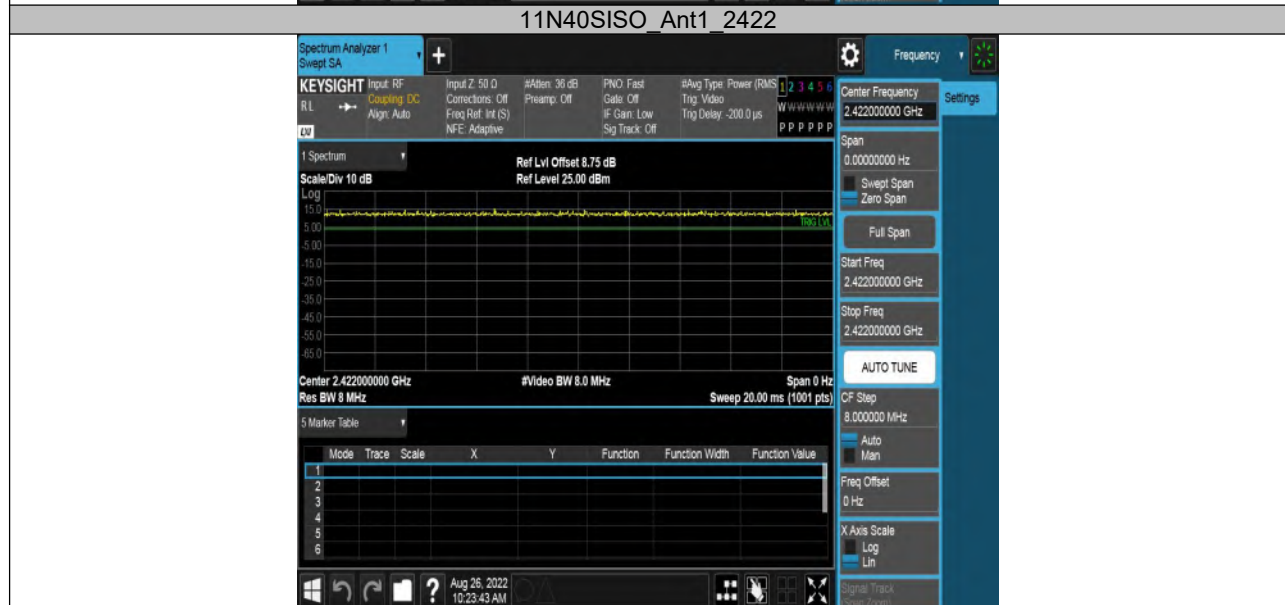
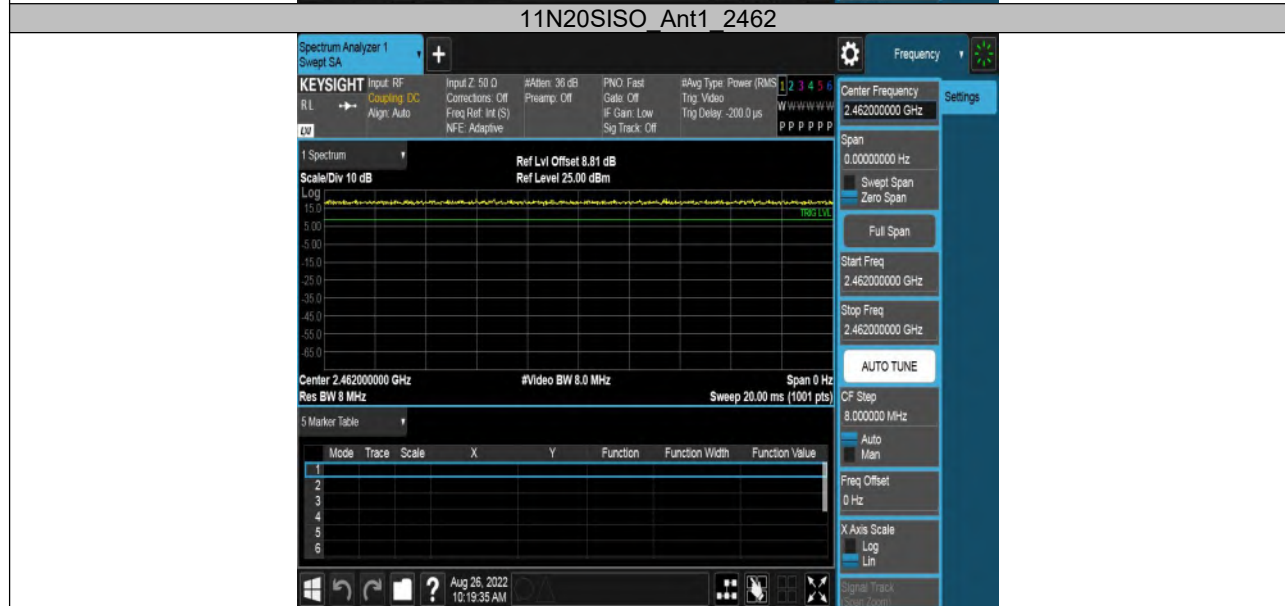
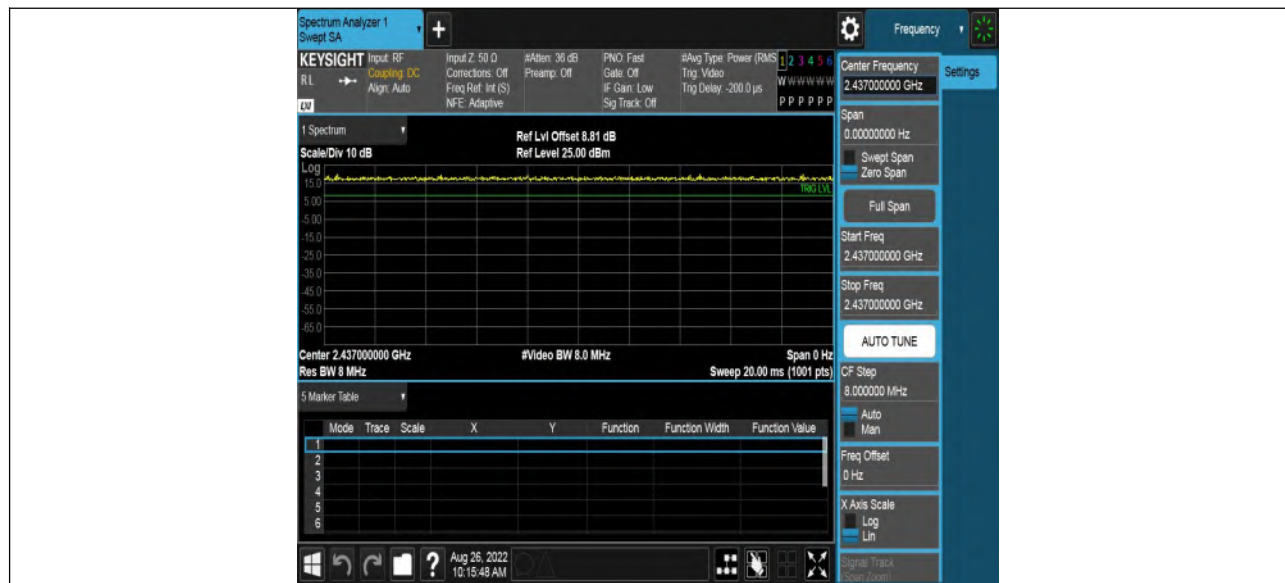

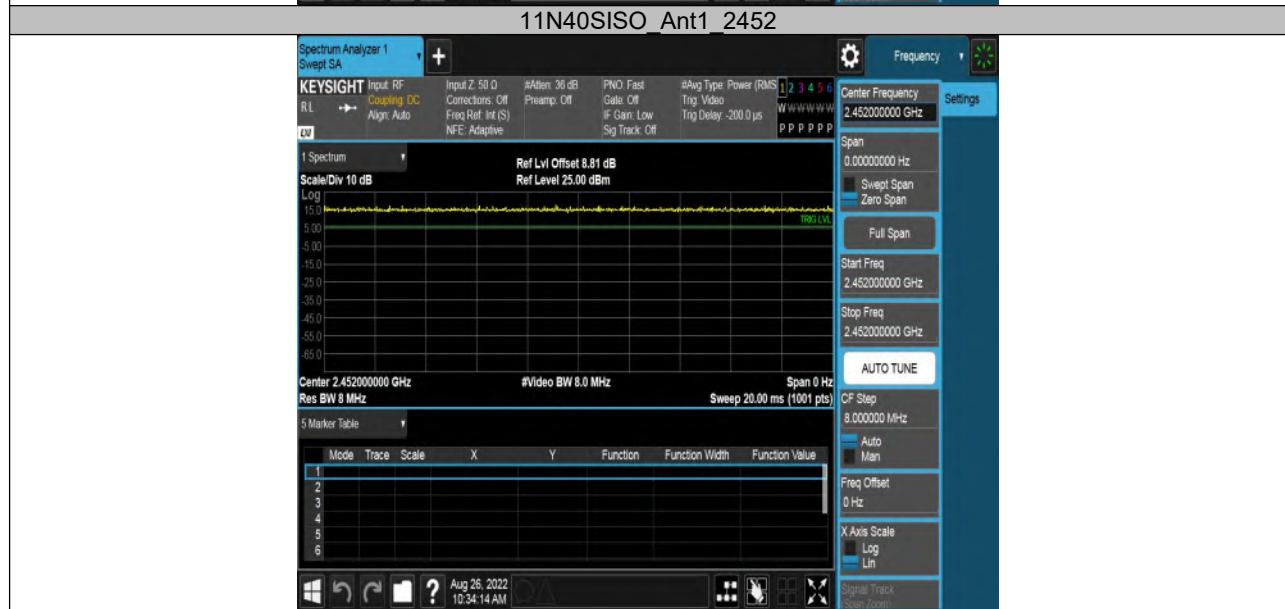

9. 6 dB DTS Bandwidth and 99 % Occupied Bandwidth

9.1. Block diagram of test setup

Same as section 8.1

9.2. Limits

CFR 47 FCC Part15 (15.247) Subpart C			
Section	Test Item	Limit	Frequency Range (MHz)
CFR 47 FCC 15.247(a)(2)	6 dB Bandwidth	≥ 500 kHz	2400-2483.5

9.3. Test Procedure

Connect the UUT to the spectrum analyzer and use the following settings:

Center Frequency	The center frequency of the channel under test
Detector	Peak
RBW	For 6 dB Bandwidth :100 kHz
VBW	For 6 dB Bandwidth: $\geq 3 \times$ RBW
Trace	Max hold
Sweep	Auto couple

Allow the trace to stabilize and measure the maximum width of the emission that is constrained by the frequencies associated with the two outermost amplitude points (upper and lower frequencies) that are attenuated by 6 dB relative to the maximum level measured in the fundamental emission.

9.4. Results

Test Mode	Ant.	Freq. [MHz]	DTS BW [MHz]	FL [MHz]	FH [MHz]	Limit [MHz]	Verdict
11B	Ant1	2412	10.000	2407.000	2417.000	0.5	PASS
		2437	9.240	2432.000	2441.240	0.5	PASS
		2462	9.360	2457.000	2466.360	0.5	PASS
11G	Ant1	2412	16.400	2403.760	2420.160	0.5	PASS
		2437	16.360	2428.760	2445.120	0.5	PASS
		2462	16.400	2453.760	2470.160	0.5	PASS
11N20SISO	Ant1	2412	17.040	2403.440	2420.480	0.5	PASS
		2437	17.040	2428.440	2445.480	0.5	PASS
		2462	17.000	2453.400	2470.400	0.5	PASS
11N40SISO	Ant1	2422	32.560	2405.680	2438.240	0.5	PASS
		2437	32.560	2420.680	2453.240	0.5	PASS
		2452	32.560	2435.680	2468.240	0.5	PASS

9.5. Original test data







11N20SISO_Ant1_2437





10. Conducted Output Power

10.1. Block diagram of test setup

Same as section 8.1

10.2. Limits

CFR 47 FCC Part15 (15.247) Subpart C			
Section	Test Item	Limit	Frequency Range (MHz)
CFR 47 FCC 15.247(b)(3)	Peak Output Power	1 watt or 30 dBm	2400-2483.5

10.3. Test Procedure

Place the EUT on the table and set it in the transmitting mode.

Remove the antenna from the EUT and then connect a low loss RF cable from the antenna port to the Power sensor.

Measure peak power each channel.

Peak Detector use for Peak result.

10.4. Results

Test Mode	Ant.	Freq. [MHz]	Peak Power [dBm]	Conducted Limit [dBm]	Verdict
11B	Ant1	2412	15.59	≤30.00	PASS
		2437	21.80	≤30.00	PASS
		2462	23.63	≤30.00	PASS
11G	Ant1	2412	15.66	≤30.00	PASS
		2437	20.61	≤30.00	PASS
		2462	21.39	≤30.00	PASS
11N20SISO	Ant1	2412	15.82	≤30.00	PASS
		2437	20.57	≤30.00	PASS
		2462	21.32	≤30.00	PASS
11N40SISO	Ant1	2422	16.99	≤30.00	PASS
		2437	19.96	≤30.00	PASS
		2452	20.39	≤30.00	PASS

11. Power Spectral Density

11.1. Block diagram of test setup

Same as section 8.1

11.2. Limits

CFR 47 FCC Part15 (15.247) Subpart C			
Section	Test Item	Limit	Frequency Range (MHz)
CFR 47 FCC §15.247 (e)	Power Spectral Density	8 dBm/3 kHz	2400-2483.5

11.3. Test Procedure

Connect the UUT to the spectrum analyser and use the following settings:

Center Frequency	The centre frequency of the channel under test
Detector	Peak
RBW	$3 \text{ kHz} \leq \text{RBW} \leq 100 \text{ kHz}$
VBW	$\geq 3 \times \text{RBW}$
Span	1.5 x DTS bandwidth
Trace	Max hold
Sweep time	Auto couple.

Allow trace to fully stabilize and use the peak marker function to determine the maximum amplitude level within the RBW.

If measured value exceeds limit, reduce RBW (no less than 3 kHz) and repeat.

11.4. Results

Test Mode	Ant.	Freq. [MHz]	Result [dBm/3-100kHz]	Limit [dBm/3kHz]	Verdict
11B	Ant1	2412	-13.72	≤ 8.00	PASS
		2437	-7.4	≤ 8.00	PASS
		2462	-5.6	≤ 8.00	PASS
11G	Ant1	2412	-12.14	≤ 8.00	PASS
		2437	-9.81	≤ 8.00	PASS
		2462	-9.93	≤ 8.00	PASS
11N20SISO	Ant1	2412	-11.9	≤ 8.00	PASS
		2437	-9.73	≤ 8.00	PASS
		2462	-9.92	≤ 8.00	PASS
11N40SISO	Ant1	2422	-10.54	≤ 8.00	PASS
		2437	-10.29	≤ 8.00	PASS
		2452	-10.5	≤ 8.00	PASS

11.5. Original test data

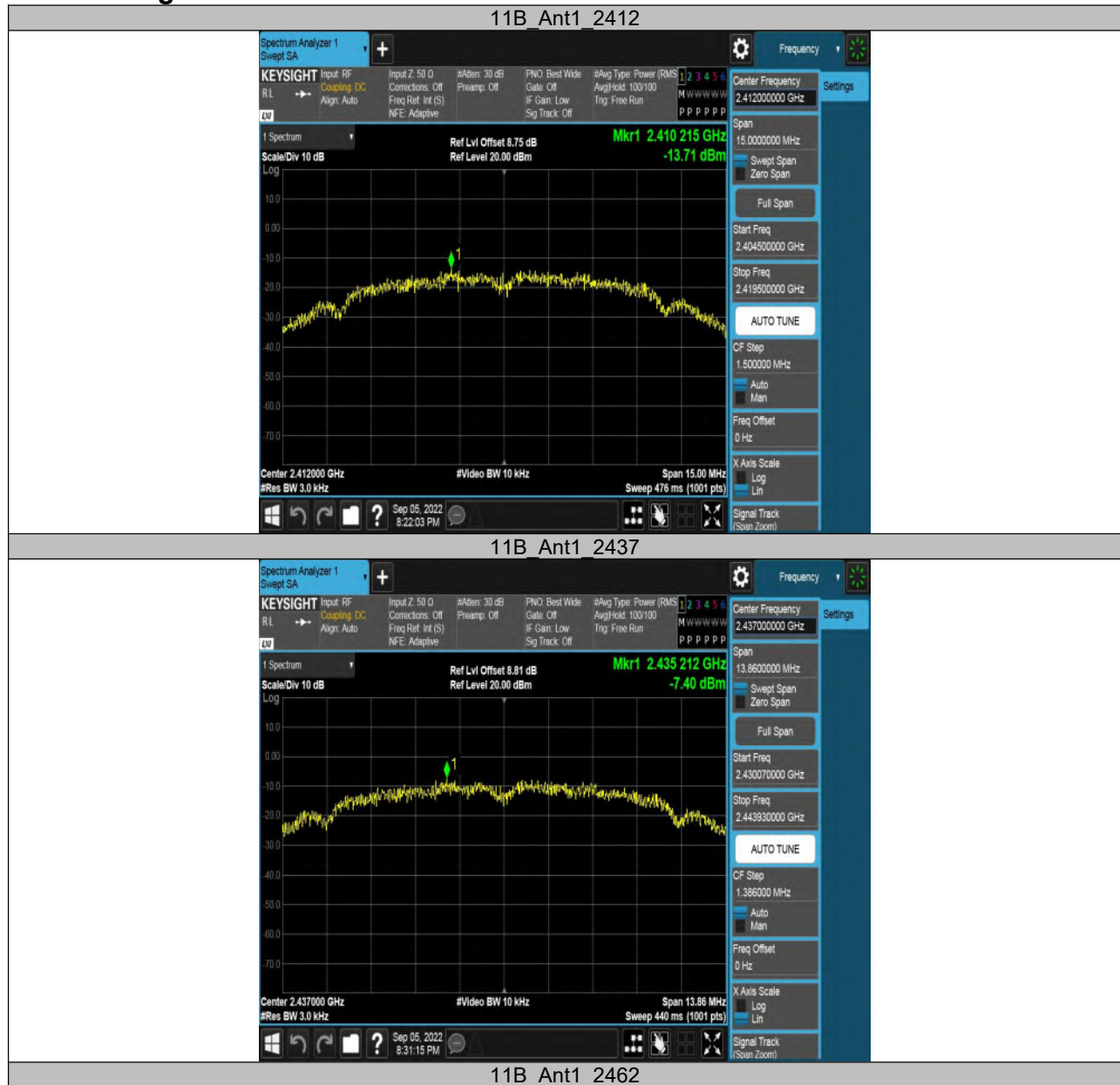

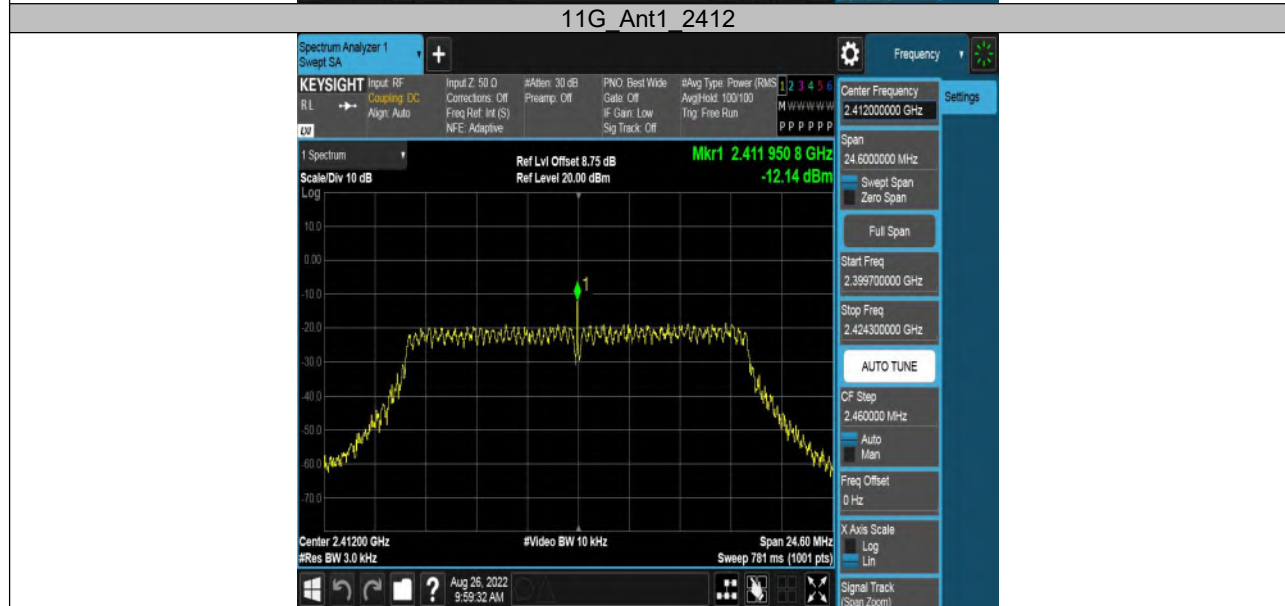

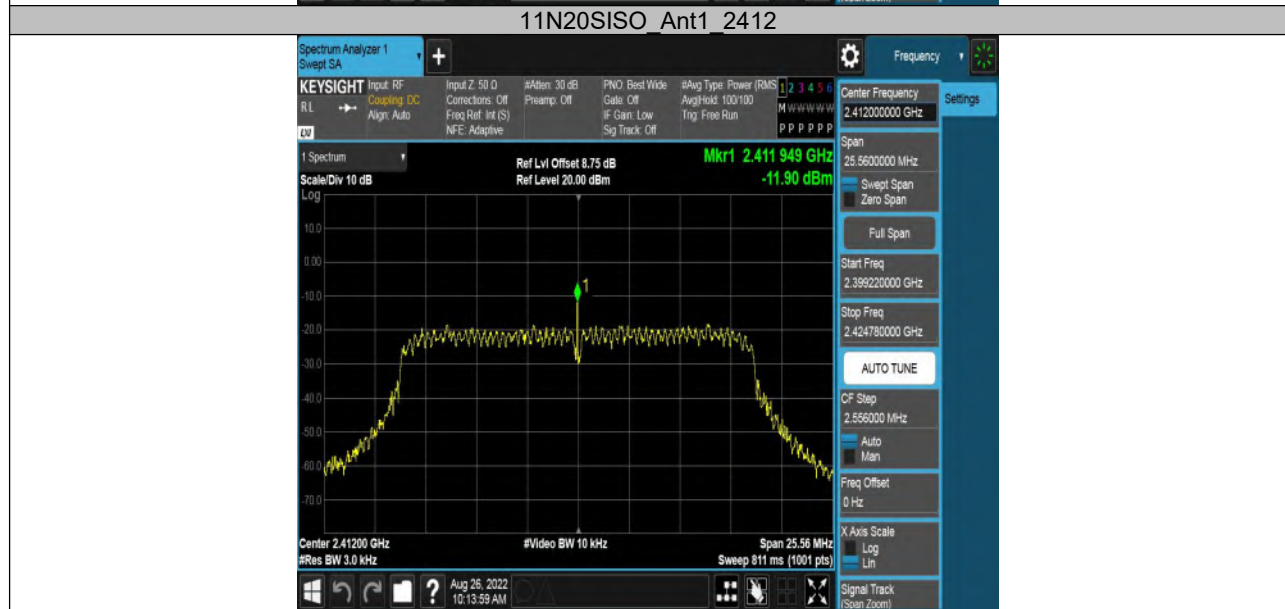

11N20SISO_Ant1_2437

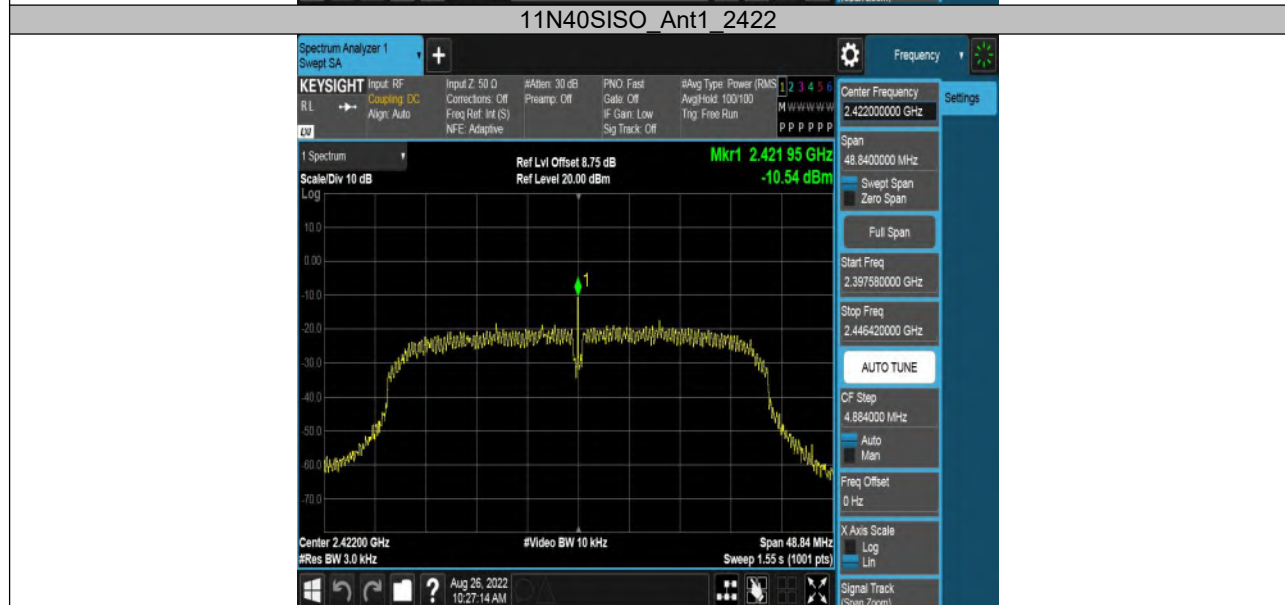
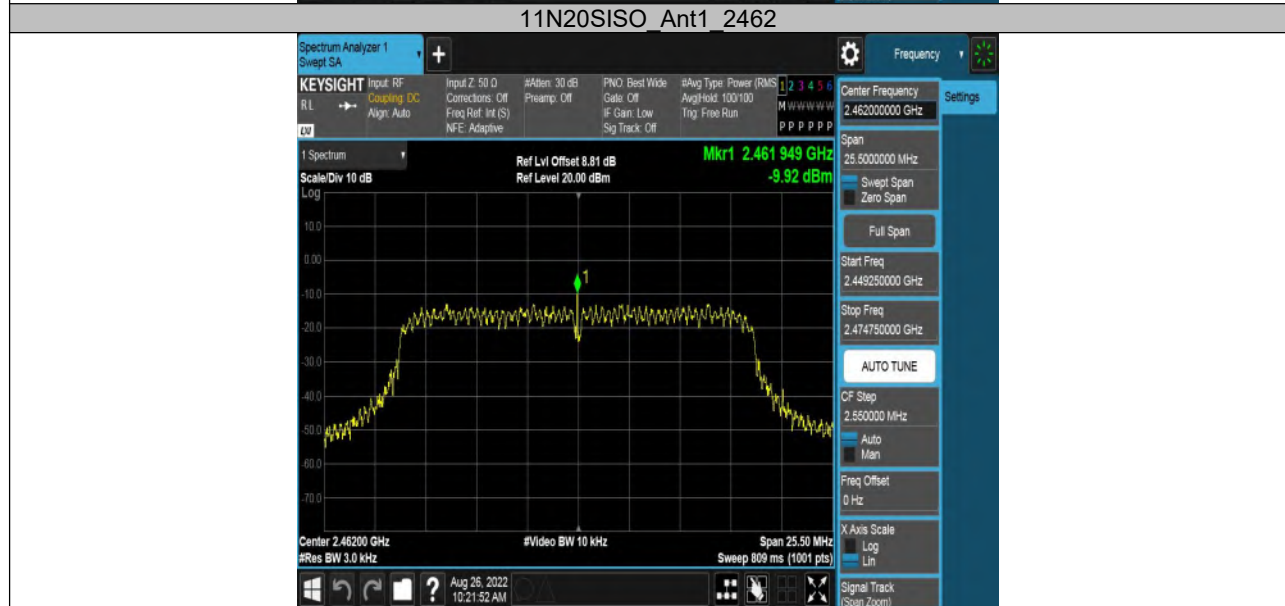
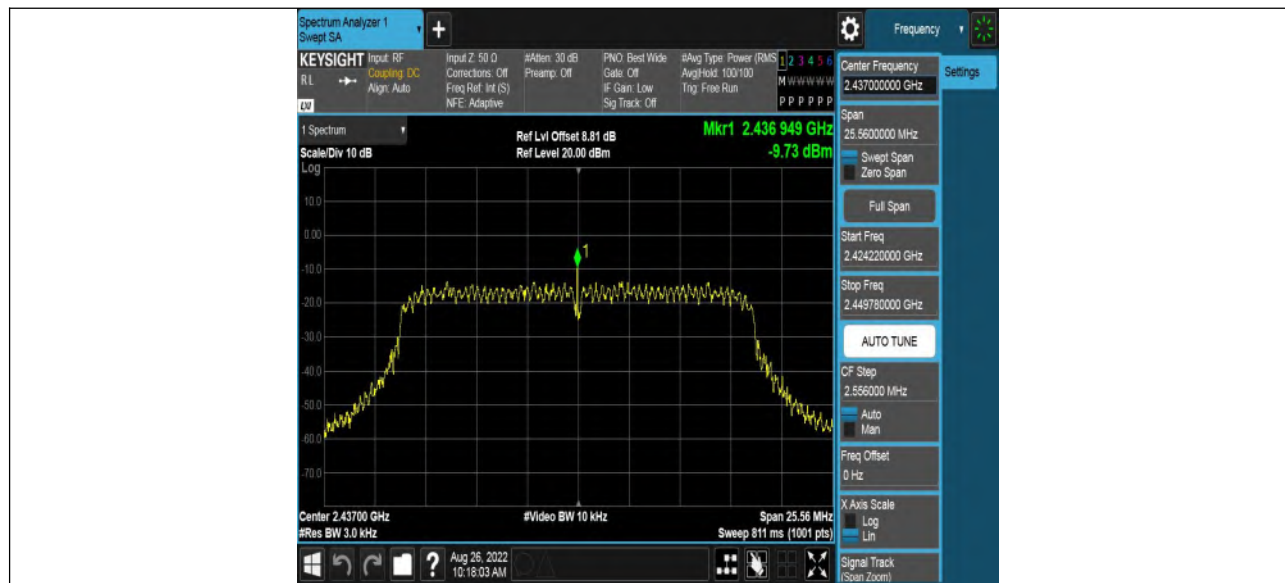



12. Conducted Band edge and Spurious Emissions

12.1. Block diagram of test setup

Same as section 8.1

12.2. Limits

CFR 47 FCC Part15 (15.247) Subpart C		
Section	Test Item	Limit
CFR 47 FCC §15.247 (d)	Conducted Bandedge and Spurious Emissions	at least 20 dB below that in the 100 kHz bandwidth within the band that contains the highest level of the desired power

12.3. Test Procedure

Center Frequency	The centre frequency of the channel under test
Detector	Peak
RBW	100 kHz
VBW	$\geq 3 \times \text{RBW}$
Span	1.5 x DTS bandwidth
Trace	Max hold
Sweep time	Auto couple.

Connect the UUT to the spectrum analyser and use the following settings:

Use the peak marker function to determine the maximum PSD level.

Span	Set the center frequency and span to encompass frequency range to be measured
Detector	Peak
RBW	100 kHz
VBW	$\geq 3 \times \text{RBW}$
measurement points	$\geq \text{span}/\text{RBW}$
Trace	Max hold
Sweep time	Auto couple.

Use the peak marker function to determine the maximum amplitude level.

12.4. Test result

Test Mode	Ant.	Ch Name	Freq. [MHz]	Ref Level [dBm]	Result [dBm]	Limit [dBm]	Verdict
11B	Ant1	Low	2412	1.15	-50.24	≤-18.85	PASS
		High	2462	9.61	-43.51	≤-10.39	PASS
11G	Ant1	Low	2412	-4.12	-44.27	≤-24.12	PASS
		High	2462	1.27	-39.82	≤-18.73	PASS
11N20SISO	Ant1	Low	2412	-3.99	-43.74	≤-23.99	PASS
		High	2462	1.67	-40.17	≤-18.33	PASS
11N40SISO	Ant1	Low	2422	-5.53	-43.44	≤-25.53	PASS
		High	2452	-2.53	-39.77	≤-22.53	PASS

Test Mode	Ant.	Freq. [MHz]	Freq Range [Mhz]	Ref Level [dBm]	Result [dBm]	Limit [dBm]	Verdict
11B	Ant1	2412	30~1000	1.15	-57.05	≤-18.85	PASS
			1000~26500	1.15	-37.31	≤-18.85	PASS
		2437	30~1000	7.95	-56.39	≤-12.05	PASS
			1000~26500	7.95	-39.5	≤-12.05	PASS
		2462	30~1000	9.61	-55.17	≤-10.39	PASS
			1000~26500	9.61	-40.74	≤-10.39	PASS
11G	Ant1	2412	30~1000	-4.12	-60.18	≤-24.12	PASS
			1000~26500	-4.12	-41.99	≤-24.12	PASS
		2437	30~1000	0.85	-58.96	≤-19.15	PASS
			1000~26500	0.85	-45.61	≤-19.15	PASS
		2462	30~1000	1.27	-57.86	≤-18.73	PASS
			1000~26500	1.27	-46.99	≤-18.73	PASS
11N20SISO	Ant1	2412	30~1000	-3.99	-59.74	≤-23.99	PASS
			1000~26500	-3.99	-42.27	≤-23.99	PASS
		2437	30~1000	0.33	-58.62	≤-19.67	PASS
			1000~26500	0.33	-45.68	≤-19.67	PASS
		2462	30~1000	1.67	-56.64	≤-18.33	PASS
			1000~26500	1.67	-47.29	≤-18.33	PASS
11N40SISO	Ant1	2422	30~1000	-5.53	-50.42	≤-25.53	PASS
			1000~26500	-5.53	-42.35	≤-25.53	PASS
		2437	30~1000	-2.74	-45.02	≤-22.74	PASS
			1000~26500	-2.74	-45.02	≤-22.74	PASS
		2452	30~1000	-2.53	-44.49	≤-22.53	PASS
			1000~26500	-2.53	-45.91	≤-22.53	PASS

12.5. Original test data

Reference level

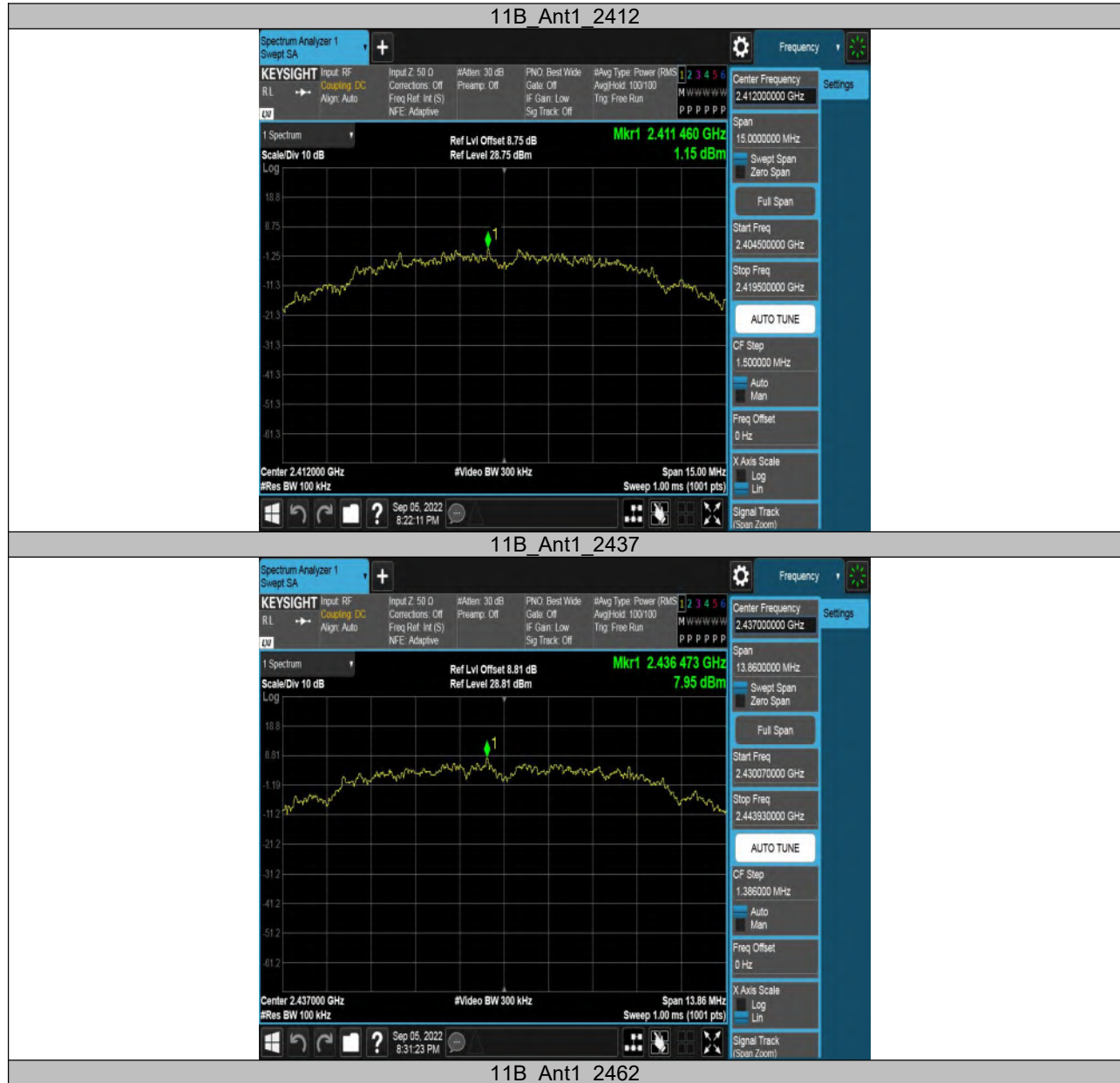





11N20SISO_Ant1_2437

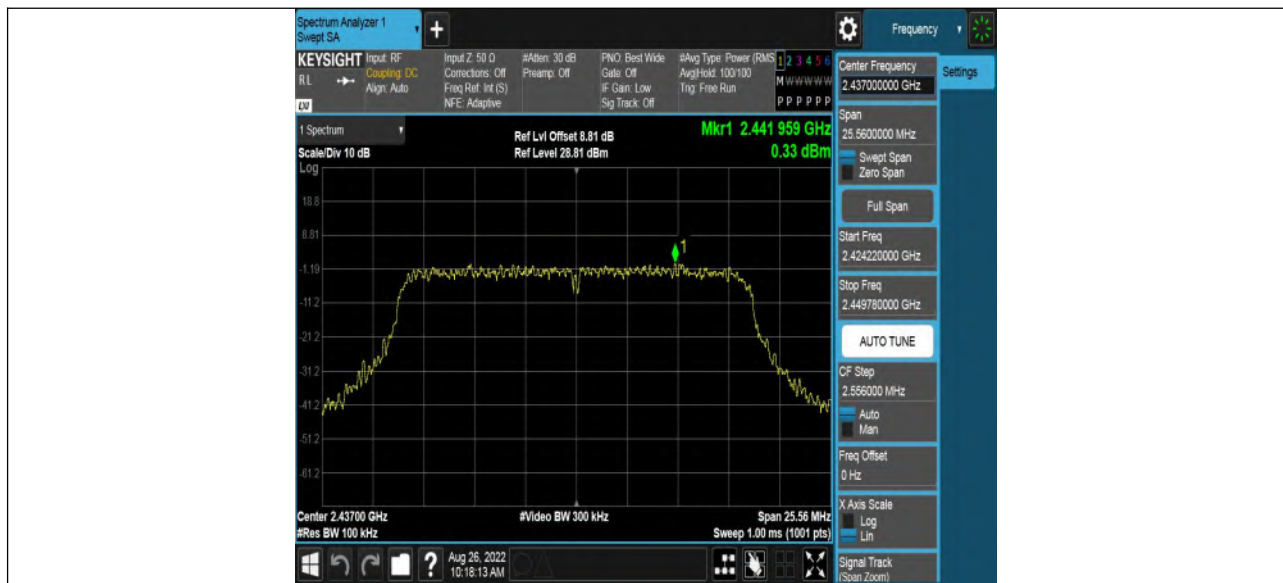

11N20SISO Ant1 2462



11N40SISO Ant1 2422





Band edge:







11N40SISO Ant1 High 2452



Spurious Emission:

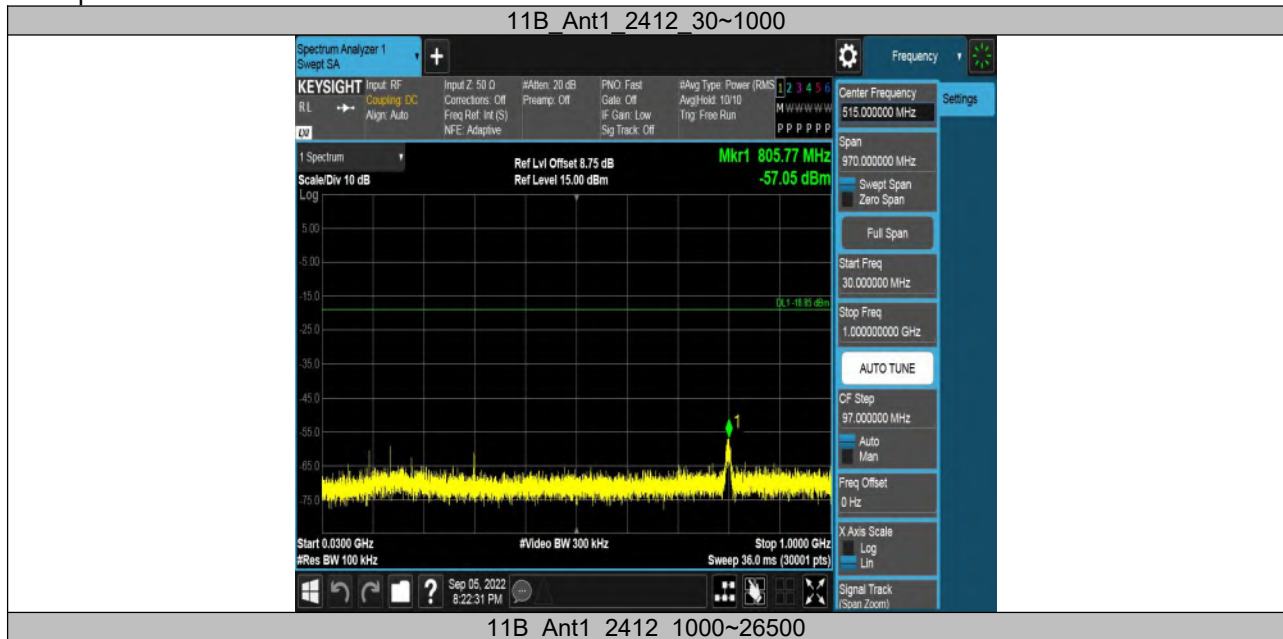

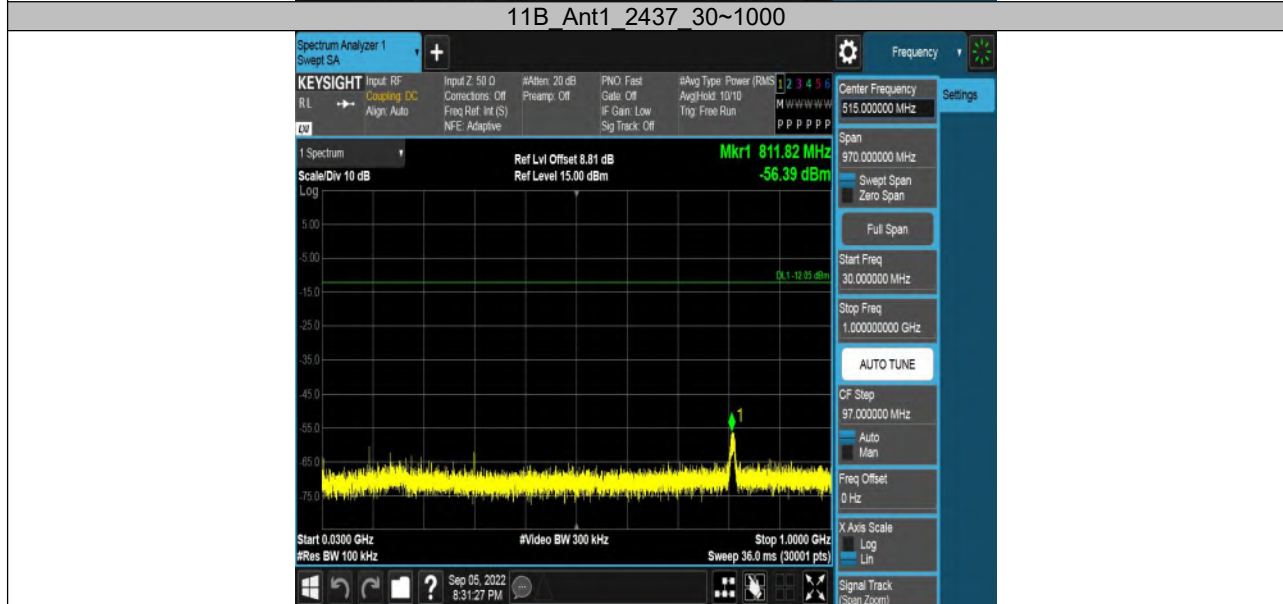
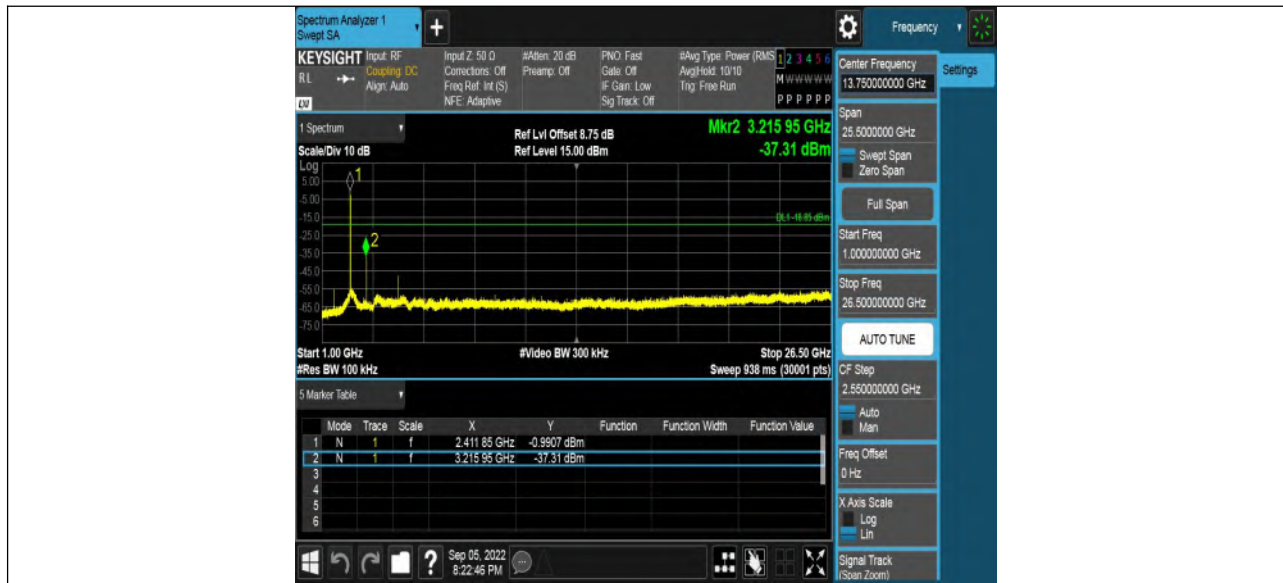

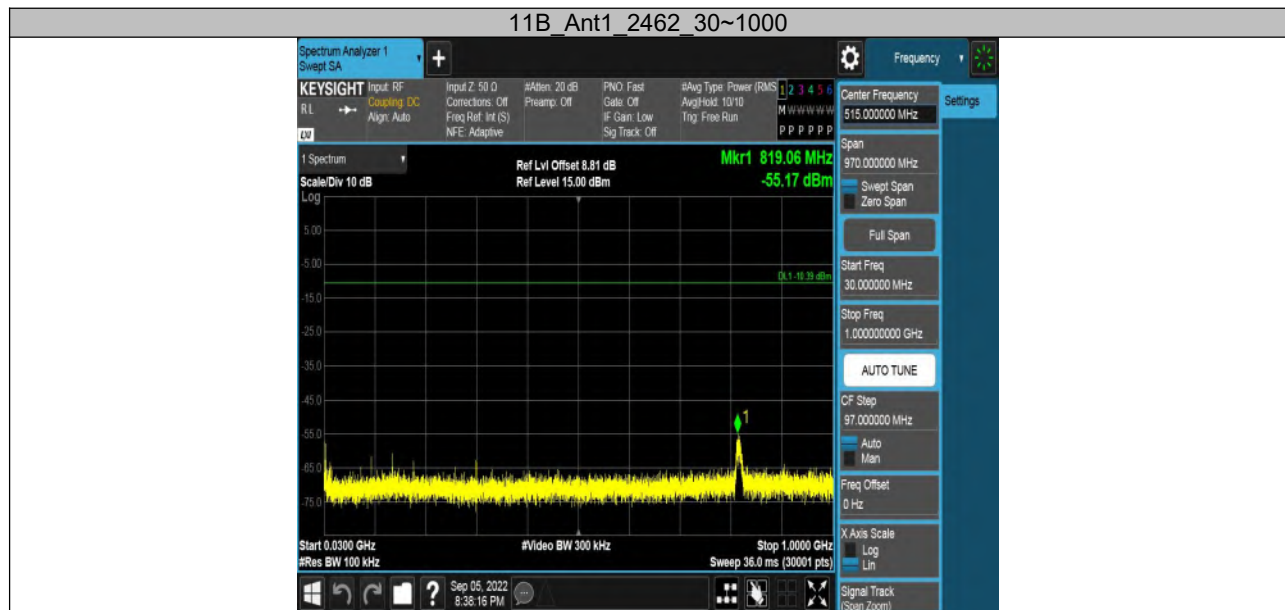

11G Ant1_2412_30~1000

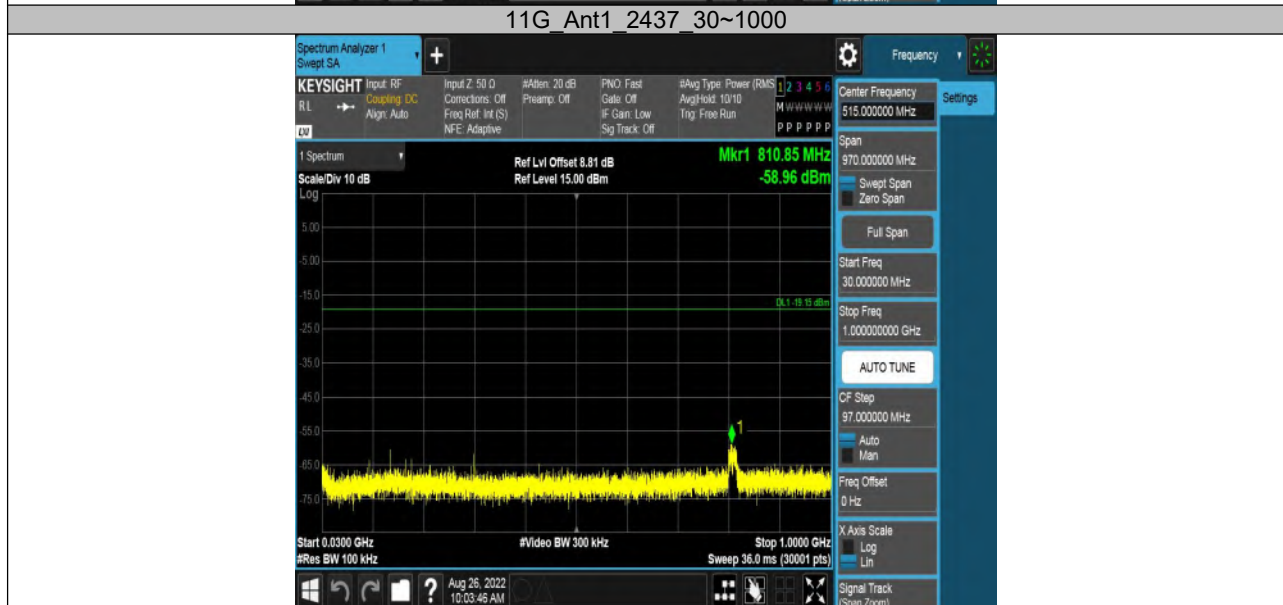
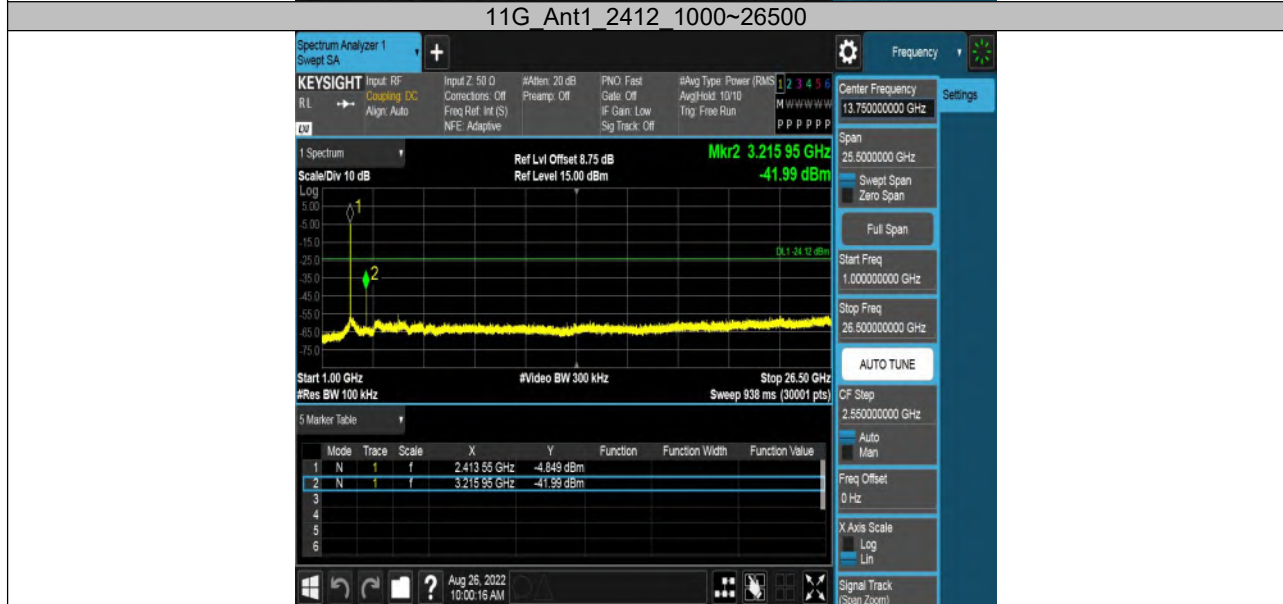
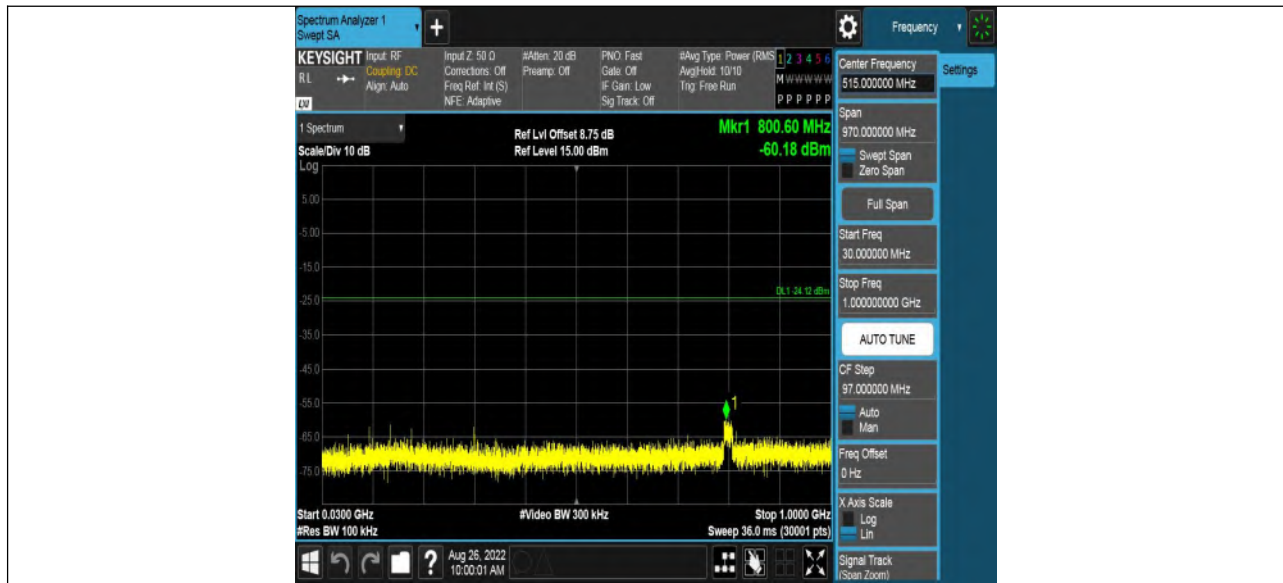

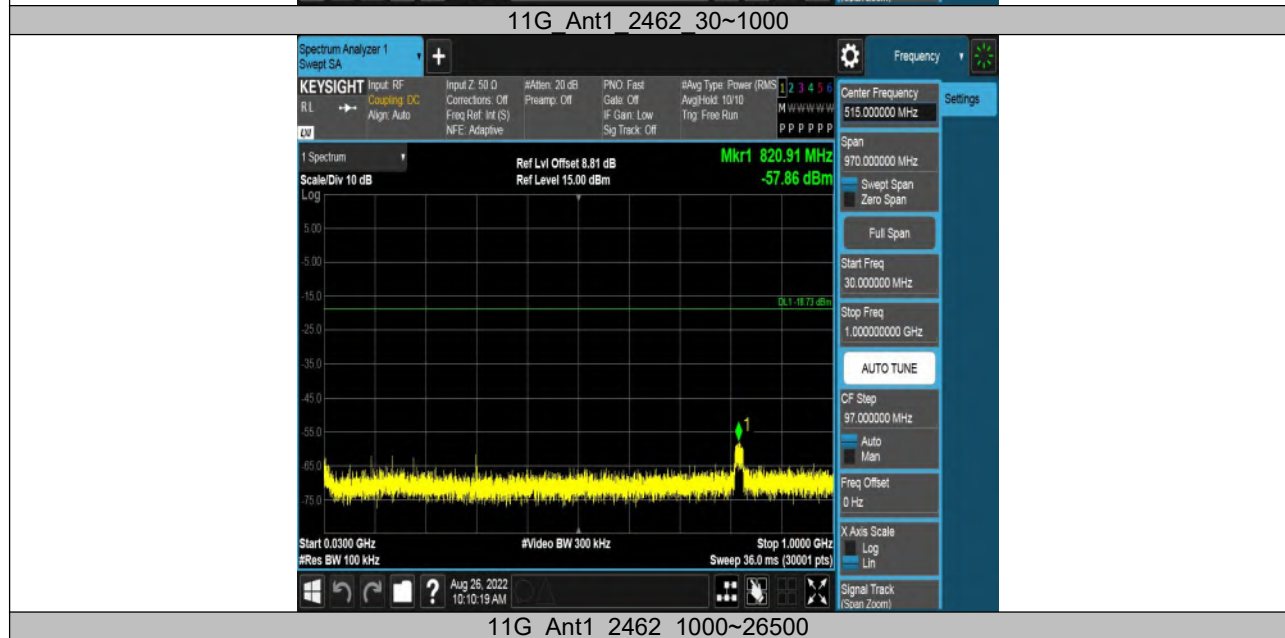

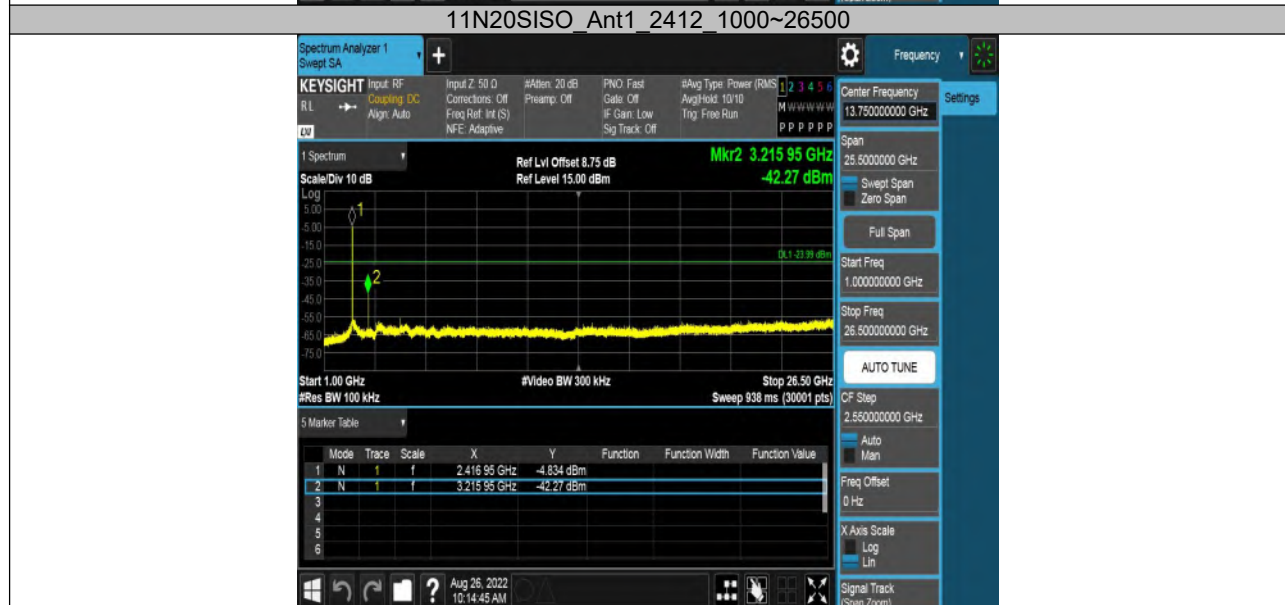
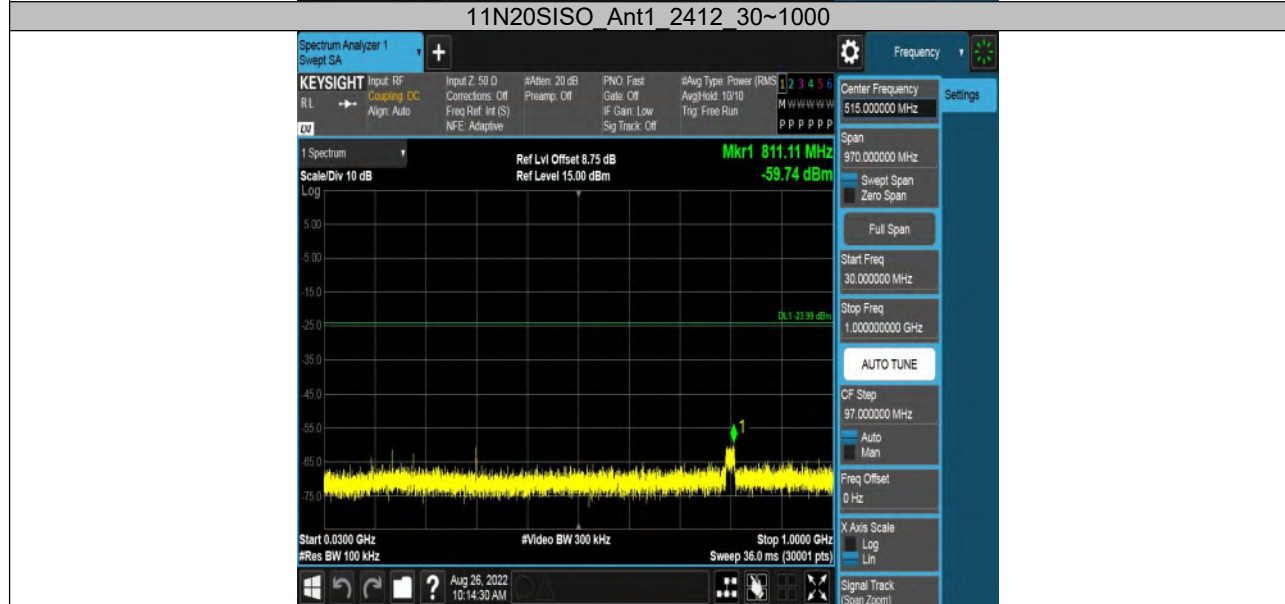

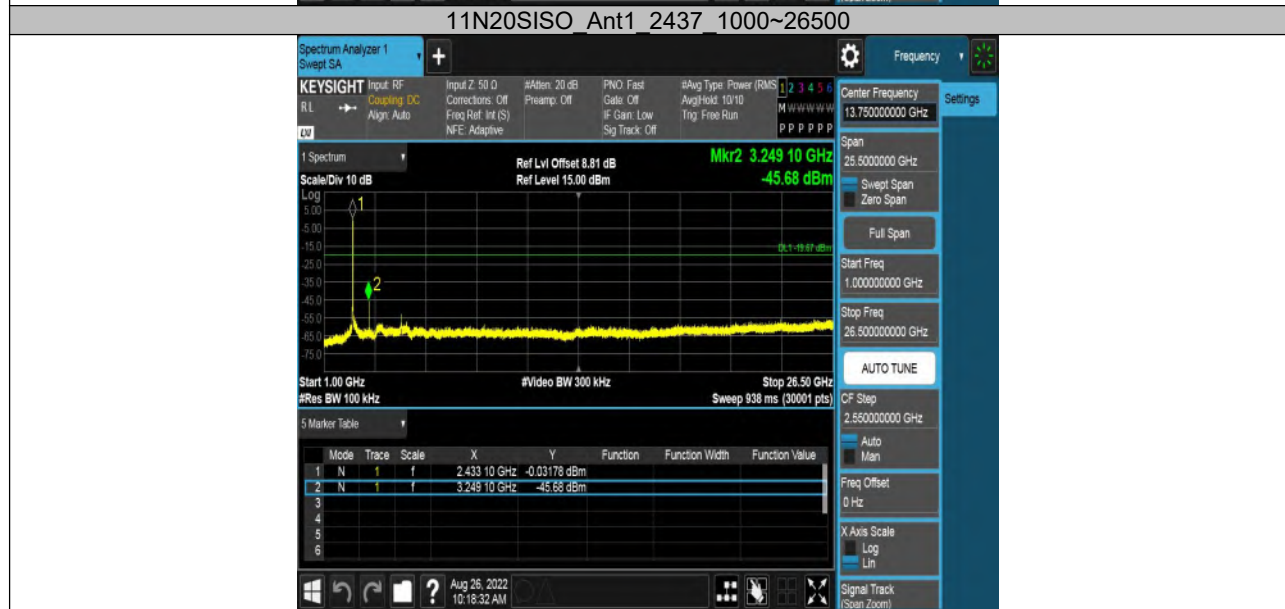
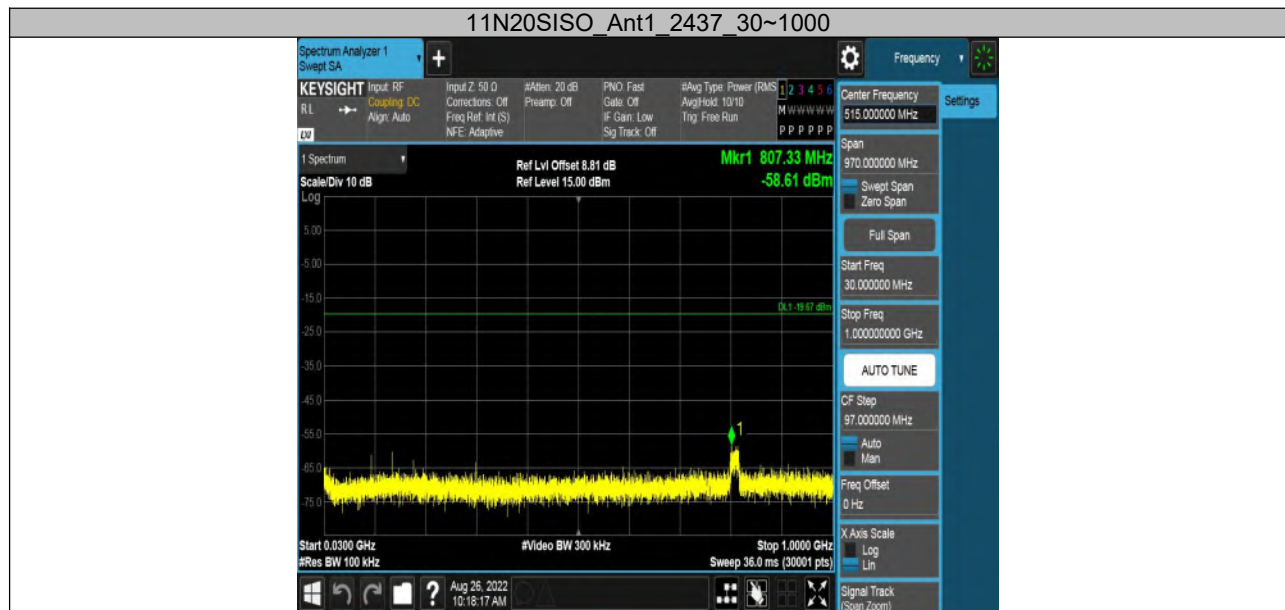

11N20SISO_Ant1_2462_30~1000

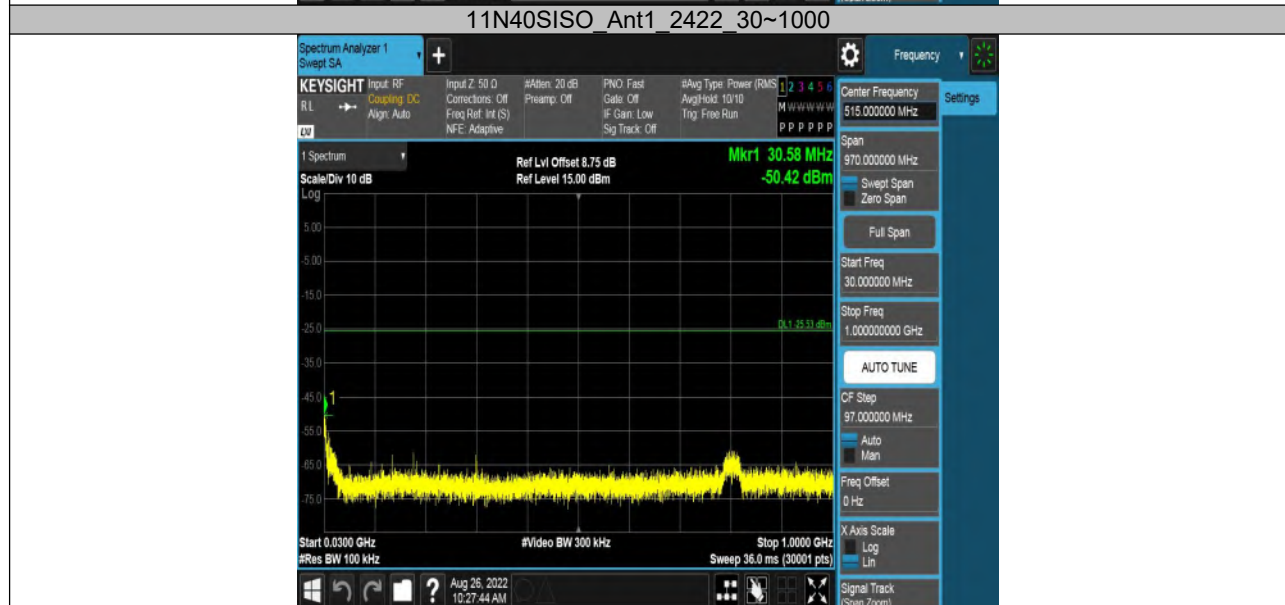
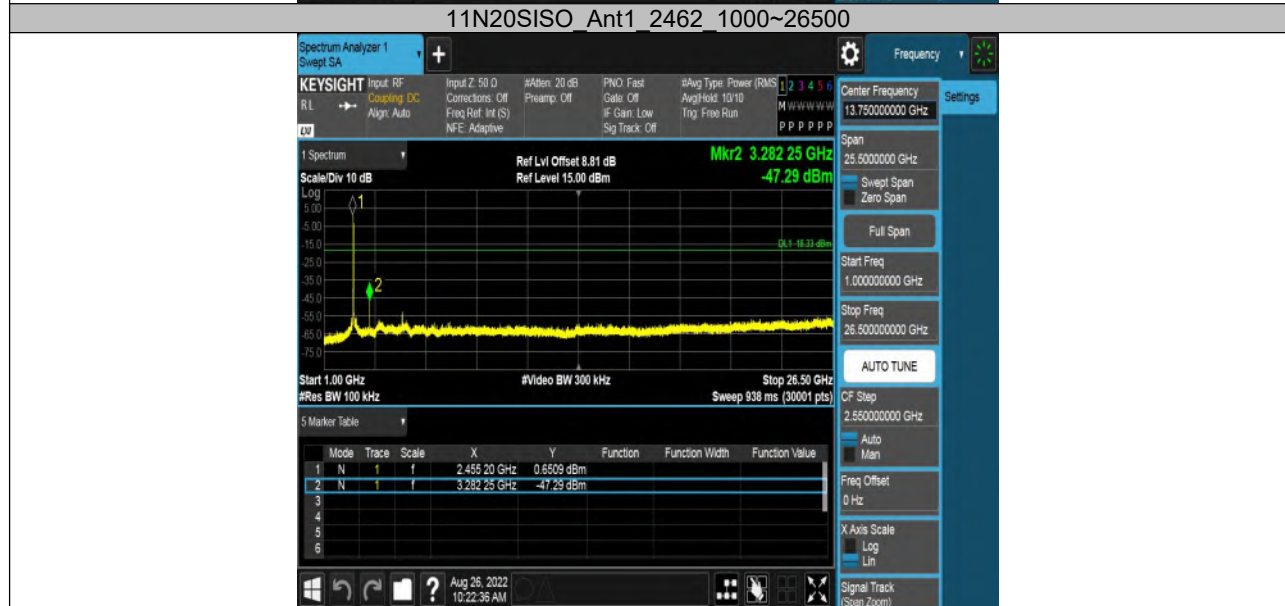
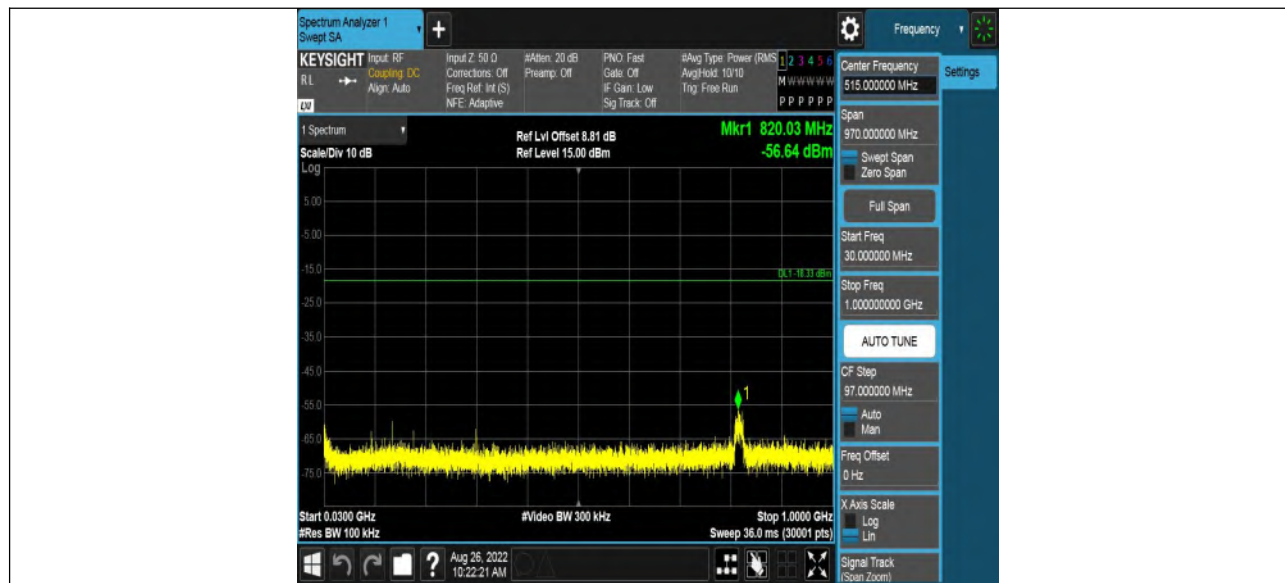

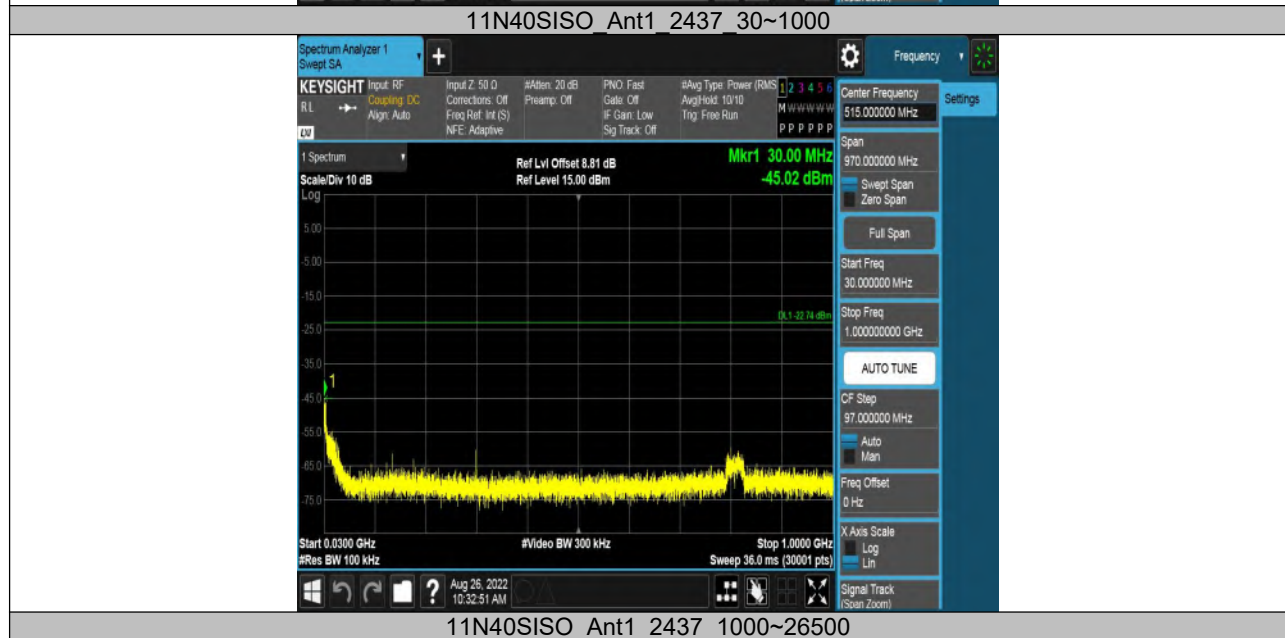
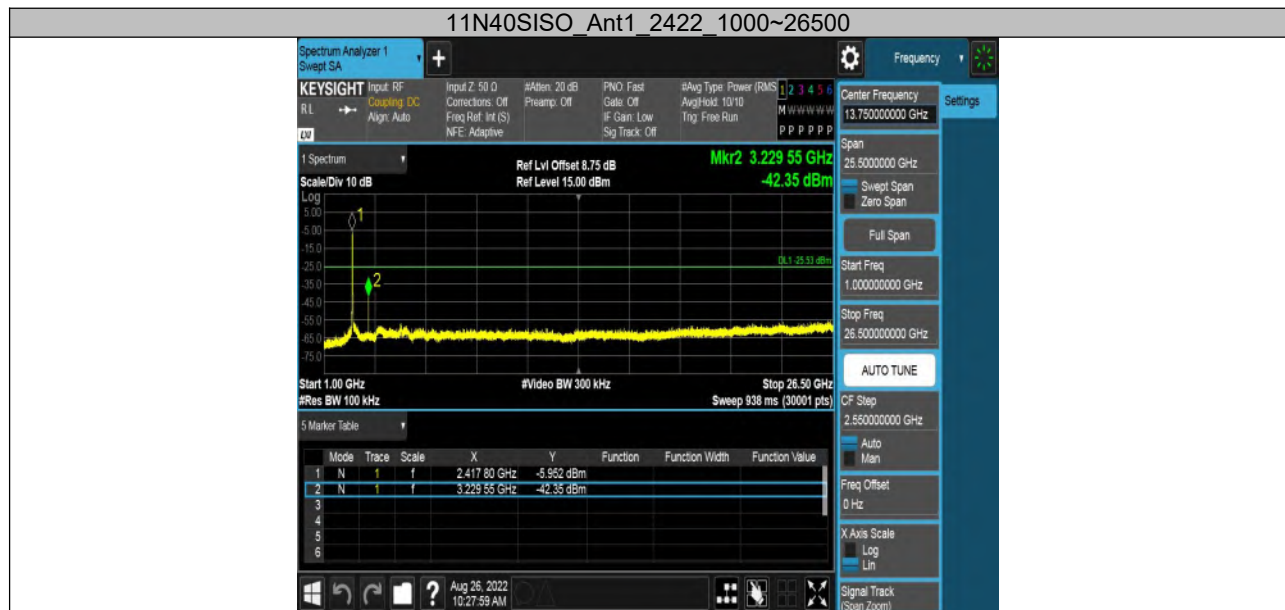

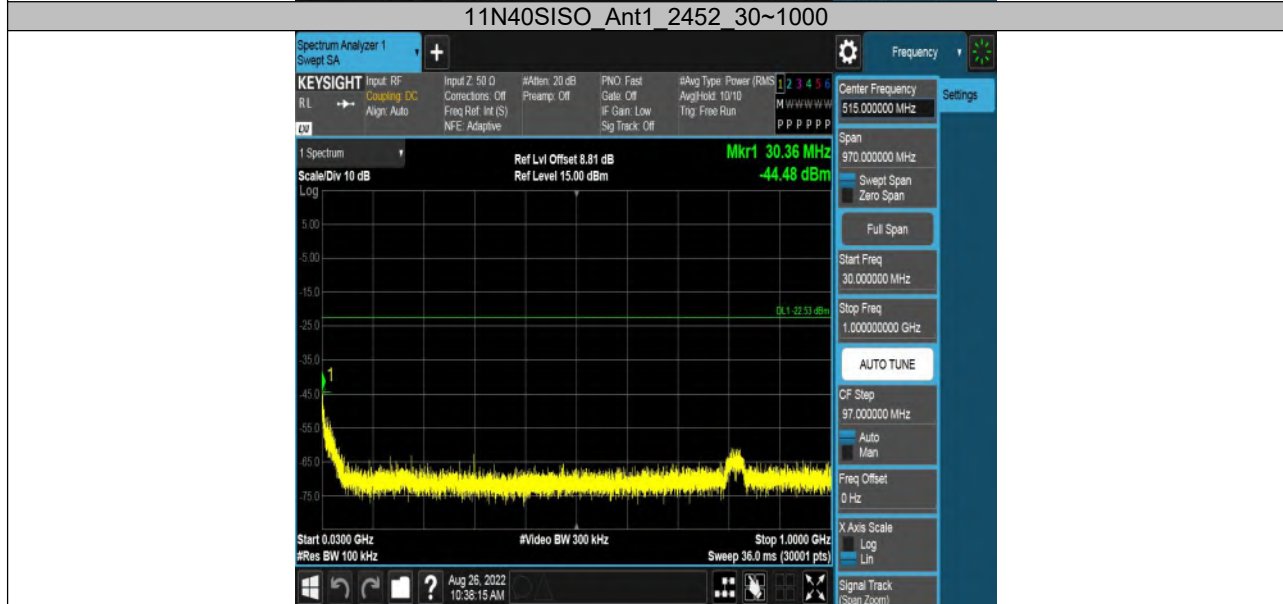

13. Radiated Emission

13.1. Block diagram of test setup

In 3 m Anechoic Chamber, test setup diagram for 9 kHz - 30 MHz:

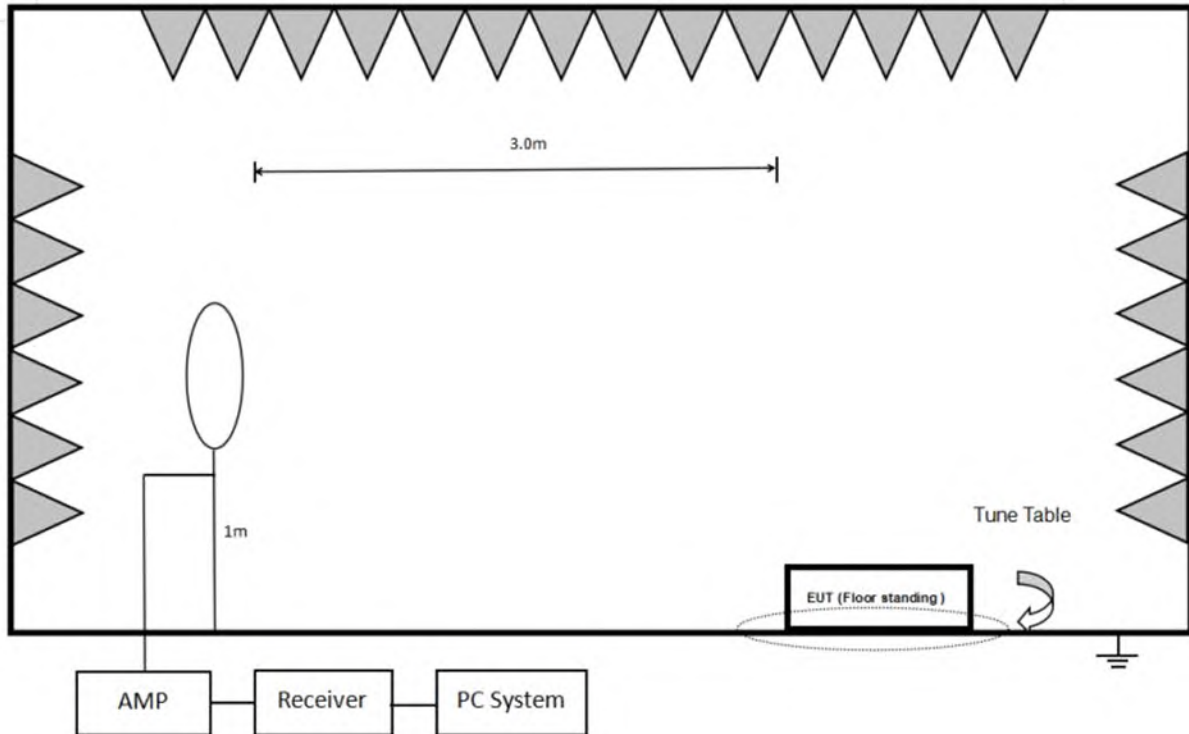

In 3 m Anechoic Chamber, test setup diagram for 30 MHz - 1 GHz:

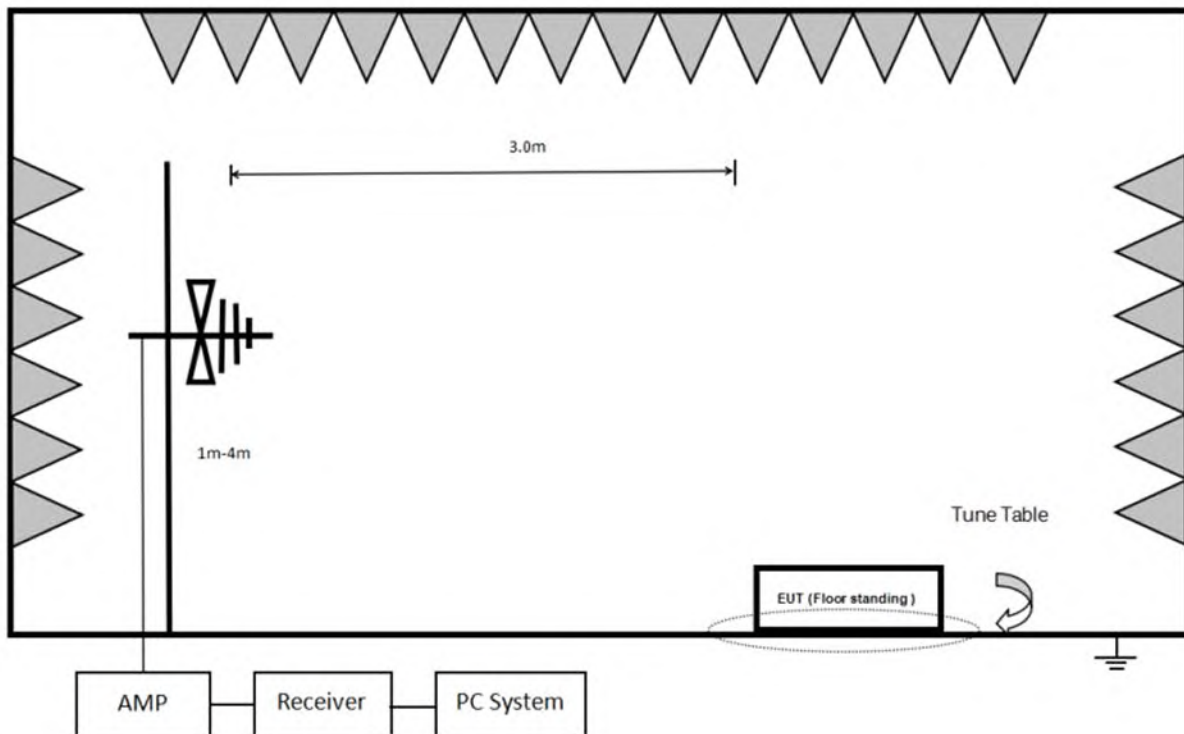

In 3 m Anechoic Chamber, test setup diagram for frequency above 1 GHz:

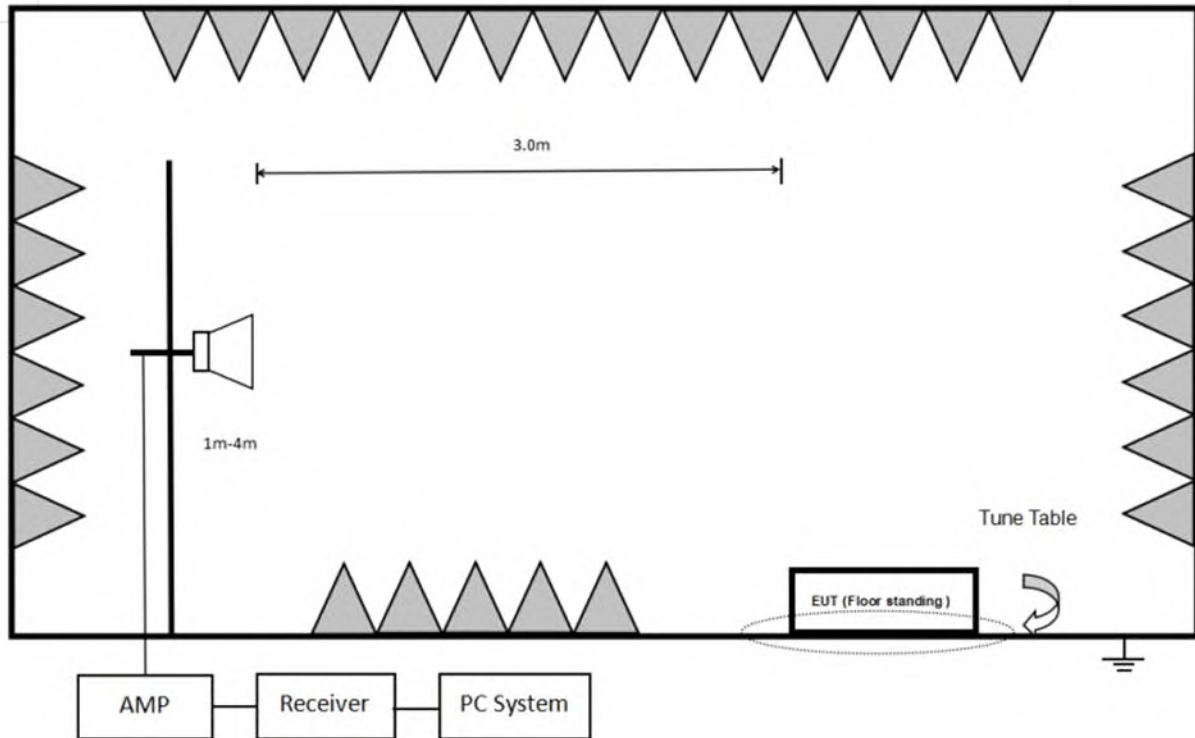

Note: For harmonic emissions test an appropriate high pass filter was inserted in the input port of AMP.

13.2. Limit

(1) FCC 15.205 Restricted frequency band

MHz	MHz	MHz	GHz
0.090-0.110	16.42-16.423	399.9-410	4.5-5.15
10.495-0.505	16.69475-16.69525	608-614	5.35-5.46
2.1735-2.1905	16.80425-16.80475	960-1240	7.25-7.75
4.125-4.128	25.5-25.67	1300-1427	8.025-8.5
4.1772&4.17775	37.5-38.25	1435-1626.5	9.0-9.2
4.2072&4.20775	73-74.6	1645.5-1646.5	9.3-9.5
6.215-6.218	74.8-75.2	1660-1710	10.6-12.7
6.26775-6.26825	108-121.94	1718.8-1722.2	13.25-13.4
6.31175-6.31225	123-138	2200-2300	14.47-14.5
8.291-8.294	149.9-150.05	2310-2390	15.35-16.2
8.362-8.366	156.52475-156.52525	2483.5-2500	17.7-21.4
8.37625-8.38675	156.7-156.9	2690-2900	22.01-23.12
8.41425-8.41475	162.0125-167.17	3260-3267	23.6-24.0
12.29-12.293	167.72-173.2	3332-3339	31.2-31.8
12.51975-12.52025	240-285	3345.8-3358	36.43-36.5
12.57675-12.57725	322-335.4	3600-4400	(²)
13.36-13.41			

¹Until February 1, 1999, this restricted band shall be 0.490-0.510 MHz.

²Above 38.6

(2) FCC 15.209 Limit.

Frequency MHz	Distance Meters	Field Strengths Limit	
		$\mu\text{V}/\text{m}$	$\text{dB}(\mu\text{V})/\text{m}$
0.009 ~ 0.490	300	$2400/F(\text{kHz})$	$67.6-20\log(F)$
0.490 ~ 1.705	30	$24000/F(\text{kHz})$	$87.6-20\log(F)$
1.705 ~ 30.0	30	30	29.54
30 ~ 88	3	100	40.0
88 ~ 216	3	150	43.5
216~960	3	200	46.0
960~1000	3	500	54.0
Above 1000	3	74.0 $\text{dB}(\mu\text{V})/\text{m}$ (Peak) 54.0 $\text{dB}(\mu\text{V})/\text{m}$ (Average)	

Note: (1) At frequencies at or above 30 MHz, measurements may be performed at a distance other than what is specified provided: measurements are not made in the near field except where it can be shown that near field measurements are appropriate due to the characteristics of the device; and it can be demonstrated that the signal levels needed to be measured at the distance employed can be detected by the measurement equipment. Measurements shall not be performed at a distance greater than 30 meters unless it can be further demonstrated that measurements at a distance of 30 meters or less are impractical. When performing measurements at a distance other than that specified, the results shall be extrapolated to the specified distance using an extrapolation factor of 20 dB/decade (inverse linear-distance for field strength measurements; inverse-linear-distance-squared for power density measurements).

(2) At frequencies below 30 MHz, measurements may be performed at a distance closer than that specified in the regulations; however, an attempt should be made to avoid making measurements in the near field. Pending the development of an appropriate measurement procedure for measurements performed below 30 MHz, when performing measurements at a closer distance than specified, the results shall be extrapolated to the specified distance by either making measurements at a minimum of two distances on at least one radial to determine the proper extrapolation factor or by using the square of an inverse linear distance extrapolation factor (40 dB/decade). This paragraph (f) shall not apply to Access BPL devices operating below 30 MHz.

About Restricted bands of operation please refer to FCC § 15.205(a).

13.3. Test Procedure

Below 30 MHz:

The setting of the spectrum Analyzer

RBW	200 Hz (From 9 kHz to 0.15 MHz)/ 9 kHz (From 0.15 MHz to 30 MHz)
VBW	200 Hz (From 9 kHz to 0.15 MHz)/ 9 kHz (From 0.15 MHz to 30 MHz)
Sweep	Auto
Trace	Max hold

1. The testing follows the guidelines in ANSI C63.10-2013

2. The EUT was arranged to its worst case and then turntable (from 0 degree to 360 degrees) to find the maximum reading. A pre-amp and a high pass filter are used for the test in order to get better signal level. Both Horizontal, Face-on and Face-off polarizations of the antenna are set to make the measurement.

3. The EUT and all cables shall be insulated, if required, from the ground plane by up to 12mm of insulating material.

4. The EUT was set 3 meters from the interference receiving antenna, which was mounted on the top of 1 meter height antenna tower.

5. The radiated emission limits are based on measurements employing a CISPR quasi-peak detector except for the frequency bands 9-90 kHz, 110-490 kHz and above 1000 MHz. Radiated emission limits in these three bands are based on measurements employing an average detector.

6. For measurement below 1 GHz, the initial step in collecting conducted emission data is a spectrum analyzer peak detector mode pre-scanning the measurement frequency range. Significant peaks are then marked and then Quasi Peak detector mode re-measured. If the emission level of the EUT measured by the peak detector is 3 dB lower than the applicable limit, the peak emission level will be reported. Otherwise, the emission measurement will be repeated using the quasi-peak detector and reported.

7. Although these tests were performed other than open field site, adequate comparison measurements were confirmed against 30m open field site. Therefore, sufficient tests were made to demonstrate that the alternative site produces results that correlate with the ones of tests made in an open field site based on KDB 414788.

Below 1 GHz and above 30 MHz:

The setting of the spectrum Analyzer

RBW	120 kHz
VBW	300 kHz
Sweep	Auto
Trace	Max hold

1. The testing follows the guidelines in ANSI C63.10-2013.

2. The EUT was arranged to its worst case and then tune the antenna tower (from 1 m to 4 m) and turntable (from 0 degree to 360 degrees) to find the maximum reading. A pre-amp and a high pass filter are used for the test in order to get better signal level. Both horizontal and vertical polarizations of the antenna are set to make the measurement.

3. The EUT and all cables shall be insulated, if required, from the ground plane by up to 12mm of insulating material.

4. The EUT was set 3 meters from the interference receiving antenna, which was mounted on the top of a variable height antenna tower.

5. For measurement below 1GHz, the initial step in collecting conducted emission data is a spectrum analyzer peak detector mode pre-scanning the measurement frequency range. Significant peaks are then marked and then Quasi Peak detector mode re-measured. If the emission level of the EUT measured by the peak detector is 3 dB lower than the applicable limit, the peak emission level will be reported. Otherwise, the emission measurement will be repeated using the quasi-peak detector and reported.

Above 1 GHz:

RBW	1 MHz
VBW	PEAK: 3 MHz AVG: see note 6
Sweep	Auto
Detector	Peak
Trace	Max hold

1. The testing follows the guidelines in ANSI C63.10-2013.

2. The EUT was arranged to its worst case and then tune the antenna tower (from 1 m to 4 m) and turntable (from 0 degree to 360 degrees) to find the maximum reading. A pre-amp and a high pass filter are used for the test in order to get better signal level. Both horizontal and vertical polarizations of the antenna are set to make the measurement.

3. The EUT and all cables shall be insulated, if required, from the ground plane by up to 12mm of insulating material.

4. The EUT was set 3 meters from the interference receiving antenna, which was mounted on the top of a variable height antenna tower.

5. For measurement above 1GHz, the emission measurement will be measured by the peak detector. This peak level, once corrected, must comply with the limit specified in Section 15.209.

6. For measurements above 1 GHz the resolution bandwidth is set to 1 MHz, then the video bandwidth is set to 3 MHz for peak measurements and 1 MHz resolution bandwidth with 1/T video bandwidth with peak detector for AVG measurements. For the Duty Cycle please refer to clause 8.1.ON TIME AND DUTY CYCLE.

7. Restriction band: Investigated frequency range from 2310 MHz to 2430 MHz and 2445 MHz to 2500 MHz, 2310 MHz to 2450 MHz and 2425 MHz to 2500MHz.

All restriction band should comply with 15.209, other emission should be at least 20 dB below the fundamental.

Note 1: For all radiated test, EUT in each of three orthogonal axis emissions had been tested, but only the worst case (X axis) data recorded in the report.

Note 2: The EUT does not support simultaneous transmission.

Note 3: The EUT was fully exercised with external accessories during the test. In the case of multiple accessory external ports, an external accessory shall be connected to one of each type of port.

13.4. Results

Pass. (See below detailed test result)

All the emissions except fundamental emission from 9 kHz to 25 GHz were comply with 15.209 limits.

Note1: According exploratory test, the emission levels are 20 dB below the limit detected from 9 kHz to 30 MHz, so the final test was performed with frequency range from 30 MHz to 26 GHz and recorded in below.

Note2: For emissions below 1 GHz, according exploratory explorer test, when change Tx mode and channel, have no distinct influence on emissions level, so for emissions below 1 GHz, the final test was only performed with EUT working in 11B , Tx CH1 mode.

Note3: For emissions above 1 GHz. If peak results comply with AV limit, AV Result is deemed to comply with AV limit.

13.5. Original test data

Below 1 GHz and above 30 MHz test data Refer to appendix A

Above 1 GHz test data Refer to appendix B

14. AC Power Line Conducted Emissions

14.1. Block diagram of test setup

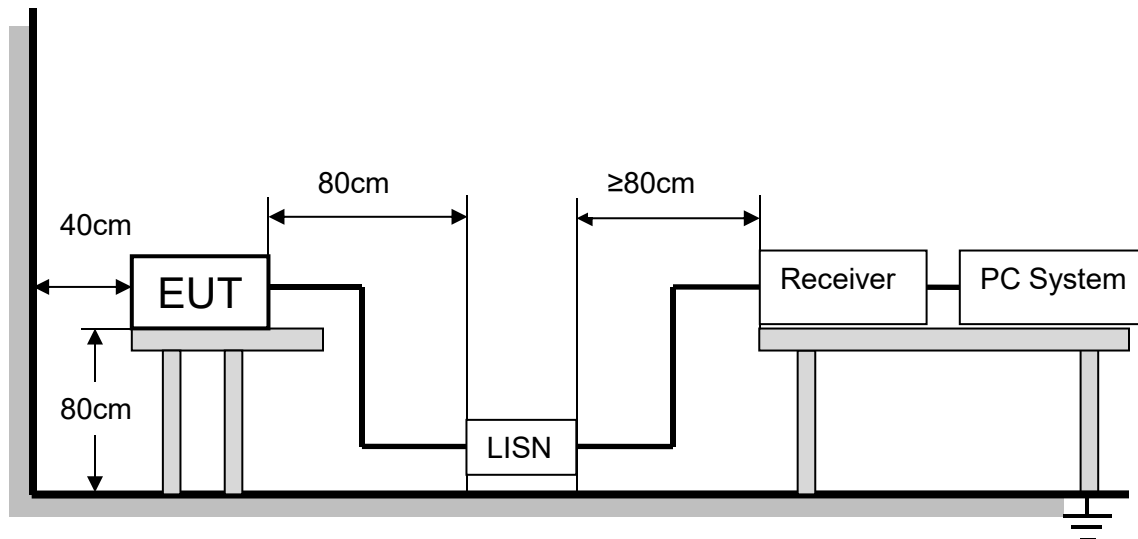

The EUT is put on a table of non-conducting material that is 80 cm high. The vertical conducting wall of shielding is located 40 cm to the rear of the EUT. The power line of the EUT is connected to the AC mains through an Artificial Mains Network (A.M.N.). A EMI Measurement Receiver (R&S Test Receiver ESR3) is used to test the emissions from both sides of AC line. According to the requirements in Section 6.2 of ANSI C63.10-2013. Conducted emissions from the EUT measured in the frequency range between 0.15 MHz and 30 MHz using CISPR Quasi-Peak and average detector mode. The bandwidth of EMI test receiver is set at 9 kHz.

The arrangement of the equipment is installed to meet the standards and operating in a manner, which tends to maximize its emission characteristics in a normal application.

14.2. Limits

Please refer to CFR 47 FCC § 15.207 (a) .

Frequency (MHz)	Quasi-peak	Average
0.15 -0.5	66 - 56 *	56 - 46 *
0.50 -5.0	56.00	46.00
5.0 -30.0	60.00	50.00

Note 1: * Decreasing linearly with logarithm of frequency.

Note 2: The lower limit shall apply at the transition frequencies.

14.3. Test procedure

The EUT and Support equipment, if needed, were put placed on a non-metallic table, 80cm above the ground plane.

Configuration EUT to simulate typical usage as described in clause 2.4 and test equipment as described in clause 10.2 of this report.

All I/O cables were positioned to simulate typical actual usage as per ANSI C63.10.

All support equipment power received from a second LISN.

Emissions were measured on each current carrying line of the EUT using an EMI Test Receiver connected to the LISN powering the EUT.

The Receiver scanned from 150 kHz to 30 MHz for emissions in each of the test modes.

During the above scans, the emissions were maximized by cable manipulation.

The test mode(s) described in clause 2.4 were scanned during the preliminary test.

After the preliminary scan, we found the test mode producing the highest emission level.

The EUT configuration and worse cable configuration of the above highest emission levels were recorded for reference of the final test.

EUT and support equipment were set up on the test bench as per the configuration with highest emission level in the preliminary test.

A scan was taken on both power lines, Neutral and Line, recording at least the six highest emissions.

Emission frequency and amplitude were recorded into a computer in which correction factors were used to calculate the emission level and compare reading to the applicable limit.

The test data of the worst-case condition(s) was recorded.

The bandwidth of test receiver is set at 9 kHz.

14.4. Test result

Pass. (See below detailed test result)

Note1: All emissions not reported below are too low against the prescribed limits.

Note2: Pre-test AC conducted emission at both voltage AC 120V/60Hz and AC 240V/50Hz, recorded worse case.

14.5. Original test data

Refer to appendix C

15. Antenna Requirements

15.1. Applicable Requirements

Please refer to FCC §15.203

An intentional radiator shall be designed to ensure that no antenna other than that furnished by the responsible party shall be used with the device. The use of a permanently attached antenna or of an antenna that uses a unique coupling to the intentional radiator shall be considered sufficient to comply with the provisions of this section. The manufacturer may design the unit so that a broken antenna can be replaced by the user, but the use of a standard antenna jack or electrical connector is prohibited.

Please refer to FCC §15.247(b)(4)

The conducted output power limit specified in paragraph (b) of this section is based on the use of antennas with directional gains that do not exceed 6 dBi. Except as shown in paragraph (c) of this section, if transmitting antennas of directional gain greater than 6 dBi are used, the conducted output power from the intentional radiator shall be reduced below the stated values in paragraphs (b)(1), (b)(2), and (b)(3) of this section, as appropriate, by the amount in dB that the directional gain of the antenna exceeds 6 dBi.

15.2. Result

The antenna used for this product is PCB antenna and that no antenna other than that furnished by the responsible party shall be used with the device, the maximum peak gain of the transmit antenna is 4.52 dBi

APPENDIX A – Radiated Emission Below 1GHz Test Data Test Report

Project Information			
EUT:	PLUTO	Environment:	25°C/58%
Model:	SQPLUTO	SN:	
Mode:	11B_2412	Voltage:	AC120V/60Hz
Customer:		Engineer:	Roger
Remark:	power set: 6		
Test Standard:			

Start of Test: 2022-09-05 12:01:20

Test Graph

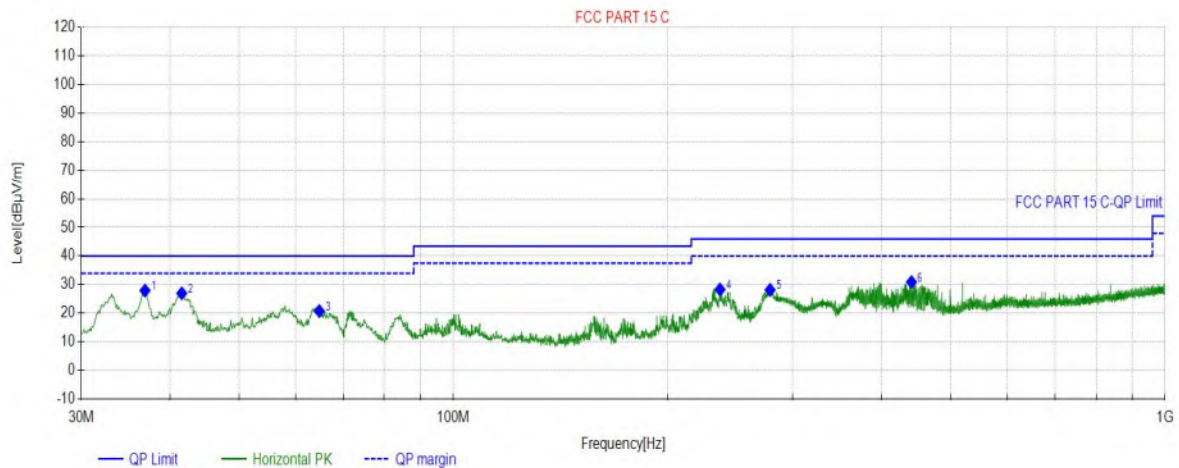

Final Data List								
NO.	Freq. [MHz]	Factor [dB]	QP Value [dBµV/m]	QP Limit [dBµV/m]	QP Margin [dB]	Height [cm]	Angle [°]	Polarity
1	36.8877	-23.13	27.95	40.00	12.05	100	358	Horizontal
2	41.5442	-21.94	26.99	40.00	13.01	100	358	Horizontal
3	64.8265	-23.83	20.78	40.00	19.22	100	358	Horizontal
4	237.0187	-21.42	28.31	46.00	17.69	100	358	Horizontal
5	278.6359	-20.59	28.15	46.00	17.85	100	221	Horizontal
6	440.2540	-16.07	30.90	46.00	15.10	100	358	Horizontal

Test Report

Project Information			
EUT:	PLUTO	Environment:	25°C/58%
Model:	SQPLUTO	SN:	
Mode:	11B_2412	Voltage:	AC120V/60Hz
Customer:		Engineer:	Roger
Remark:	power set: 6		
Test Standard:			

Start of Test: 2022-09-05 12:02:05

Test Graph

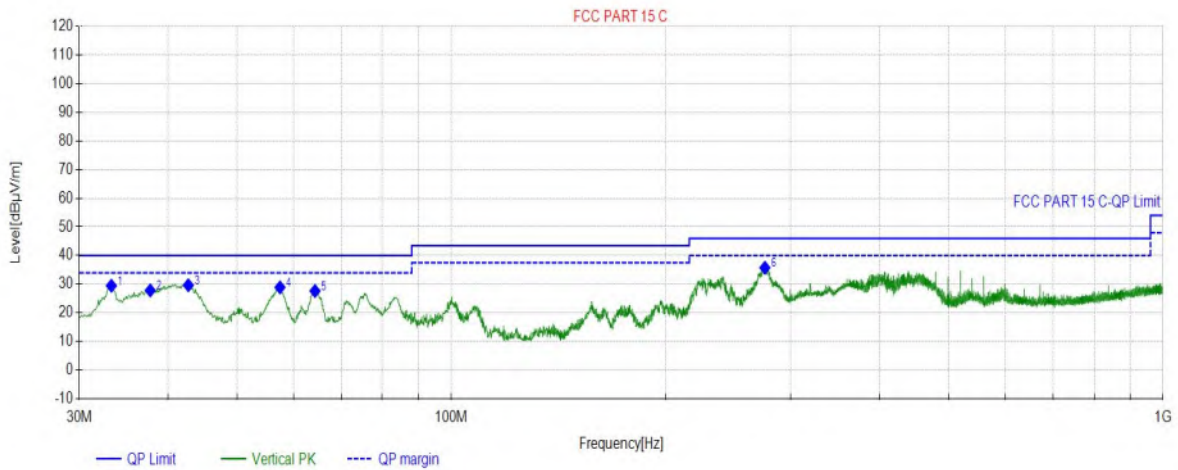

Final Data List								
NO.	Freq. [MHz]	Factor [dB]	QP Value [dBµV/m]	QP Limit [dBµV/m]	QP Margin [dB]	Height [cm]	Angle [°]	Polarity
1	33.2983	-24.31	29.48	40.00	10.52	100	218	Vertical
2	37.7608	-22.85	27.83	40.00	12.17	100	199	Vertical
3	42.7083	-21.81	29.65	40.00	10.35	100	152	Vertical
4	57.4537	-22.12	28.91	40.00	11.09	100	147	Vertical
5	64.3414	-23.70	27.65	40.00	12.35	100	157	Vertical
6	275.8226	-20.68	35.76	46.00	10.24	100	284	Vertical

APPENDIX B – Radiated Emission Above 1GHz Test Data

Test Report

Project Information			
Customer:		EUT:	PLUTO
Model:	SQPLUTO	SN:	
Mode:	11B_2412	Voltage:	AC120V/60Hz
Environment:	25°C/58%	Engineer:	Roger
Remark:	power set: 6		
Test Standard:			

Start of Test: 2022-09-02 19:58:52

Test Graph

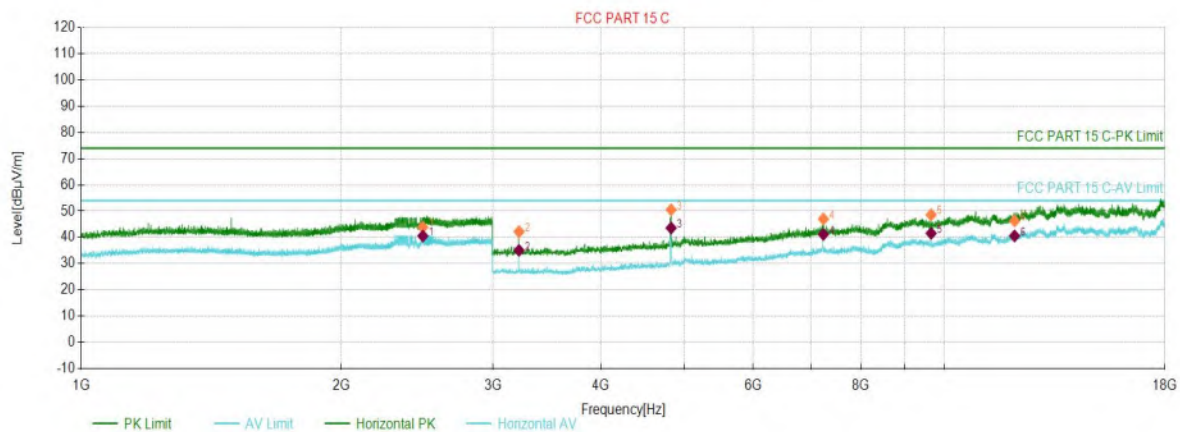

PK Final Data List

NO.	Freq. [MHz]	Factor [dB]	PK Value [dBµV/m]	PK Limit [dBµV/m]	PK Margin [dB]	Height [cm]	Angle [°]	Polarity
1	2487.3487	7.73	43.87	74.00	30.13	150	129	Horizontal
2	3214.5215	-16.03	42.17	74.00	31.83	150	287	Horizontal
3	4822.6823	-9.98	50.51	74.00	23.49	150	143	Horizontal
4	7237.9238	-1.50	47.03	74.00	26.97	150	243	Horizontal
5	9647.1647	2.89	48.62	74.00	25.38	150	149	Horizontal
6	12051.9052	5.89	46.29	74.00	27.71	150	74	Horizontal

AV Final Data List

NO.	Freq. [MHz]	Factor [dB]	AV Value [dBµV/m]	AV Limit [dBµV/m]	AV Margin [dB]	Height [cm]	Angle [°]	Polarity
1	2487.3487	7.73	40.52	54.00	13.48	150	129	Horizontal
2	3214.5215	-16.03	35.05	54.00	18.95	150	287	Horizontal
3	4822.6823	-9.98	43.59	54.00	10.41	150	143	Horizontal
4	7237.9238	-1.50	41.15	54.00	12.85	150	243	Horizontal
5	9647.1647	2.89	41.54	54.00	12.46	150	149	Horizontal
6	12051.9052	5.89	40.56	54.00	13.44	150	74	Horizontal

Test Report

Project Information			
Customer:		EUT:	PLUTO
Model:	SQPLUTO	SN:	
Mode:	11B_2412	Voltage:	AC120V/60Hz
Environment:	25°C/58%	Engineer:	Roger
Remark:	power set: 6		
Test Standard:			

Start of Test: 2022-09-02 20:00:36

Test Graph

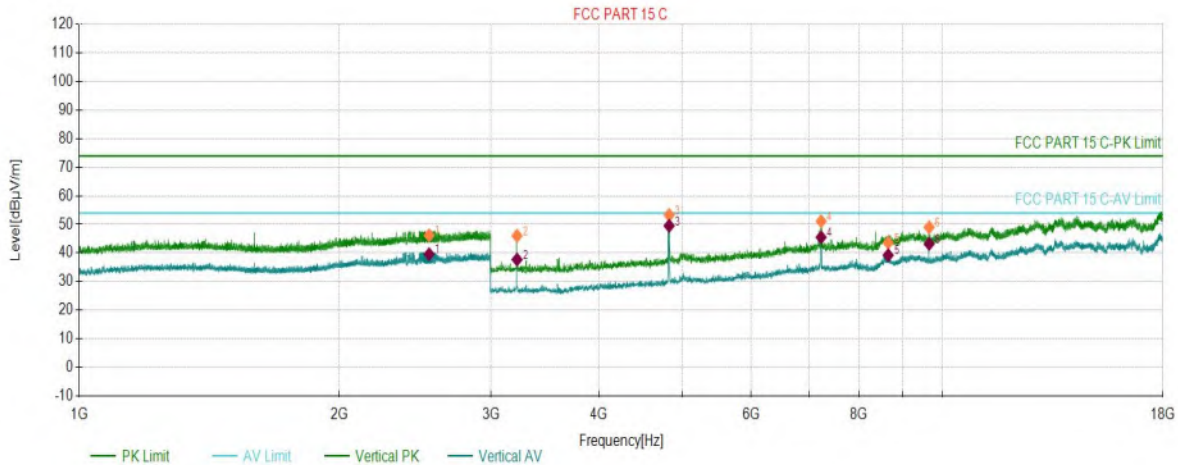

PK Final Data List

NO.	Freq. [MHz]	Factor [dB]	PK Value [dBµV/m]	PK Limit [dBµV/m]	PK Margin [dB]	Height [cm]	Angle [°]	Polarity
1	2543.1543	7.60	46.19	74.00	27.81	150	206	Vertical
2	3214.5215	-16.03	46.02	74.00	27.98	150	246	Vertical
3	4822.6823	-9.98	53.31	74.00	20.69	150	197	Vertical
4	7233.4233	-1.52	51.14	74.00	22.86	150	166	Vertical
5	8649.5650	2.13	43.58	74.00	30.42	150	359	Vertical
6	9647.1647	2.89	48.99	74.00	25.01	150	171	Vertical

AV Final Data List

NO.	Freq. [MHz]	Factor [dB]	AV Value [dBµV/m]	AV Limit [dBµV/m]	AV Margin [dB]	Height [cm]	Angle [°]	Polarity
1	2543.1543	7.60	39.62	54.00	14.38	150	206	Vertical
2	3214.5215	-16.03	37.74	54.00	16.26	150	246	Vertical
3	4822.6823	-9.98	49.54	54.00	4.46	150	197	Vertical
4	7233.4233	-1.52	45.51	54.00	8.49	150	166	Vertical
5	8649.5650	2.13	39.27	54.00	14.73	150	359	Vertical
6	9647.1647	2.89	43.21	54.00	10.79	150	171	Vertical

Test Report

Project Information			
Customer:		EUT:	PLUTO
Model:	SQPLUTO	SN:	
Mode:	11B_2437	Voltage:	AC120V/60Hz
Environment:	25°C/58%	Engineer:	Roger
Remark:	power set: 6		
Test Standard:			

Start of Test: 2022-09-02 20:13:17

Test Graph

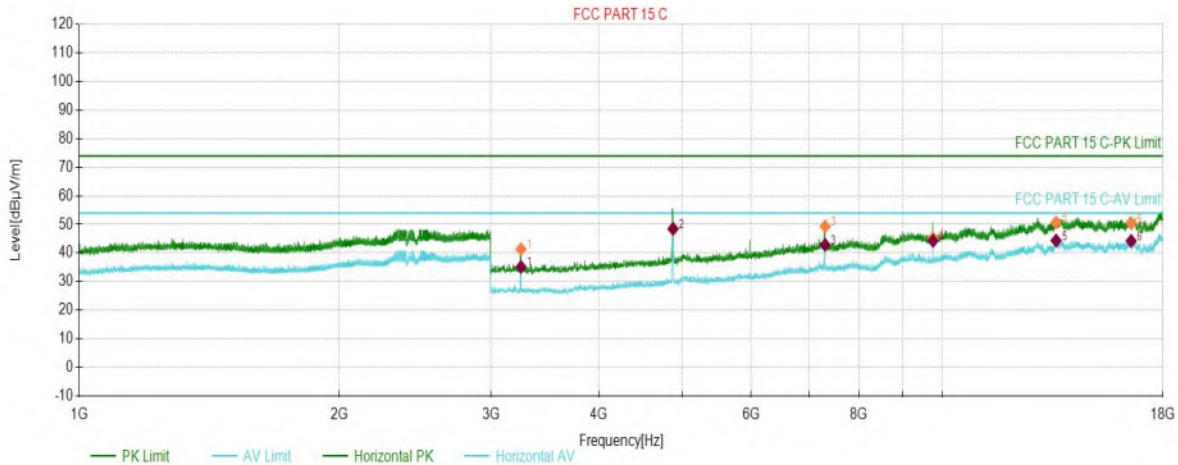

PK Final Data List

NO.	Freq. [MHz]	Factor [dB]	PK Value [dBµV/m]	PK Limit [dBµV/m]	PK Margin [dB]	Height [cm]	Angle [°]	Polarity
1	3249.0249	-16.00	41.36	74.00	32.64	150	261	Horizontal
2	4873.6874	-9.55	48.31	74.00	25.69	150	128	Horizontal
3	7309.9310	-1.33	49.31	74.00	24.69	150	228	Horizontal
4	9747.6748	3.01	45.19	74.00	28.81	150	187	Horizontal
5	13534.0534	10.55	50.68	74.00	23.32	150	163	Horizontal
6	16534.3534	11.61	50.46	74.00	23.54	150	298	Horizontal

AV Final Data List

NO.	Freq. [MHz]	Factor [dB]	AV Value [dBµV/m]	AV Limit [dBµV/m]	AV Margin [dB]	Height [cm]	Angle [°]	Polarity
1	3249.0249	-16.00	35.13	54.00	18.87	150	261	Horizontal
2	4873.6874	-9.55	48.51	54.00	5.49	150	128	Horizontal
3	7309.9310	-1.33	42.87	54.00	11.13	150	228	Horizontal
4	9747.6748	3.01	44.26	54.00	9.74	150	187	Horizontal
5	13534.0534	10.55	44.37	54.00	9.63	150	163	Horizontal
6	16534.3534	11.61	44.23	54.00	9.77	150	298	Horizontal

Test Report

Project Information			
Customer:		EUT:	PLUTO
Model:	SQPLUTO	SN:	
Mode:	11B_2437	Voltage:	AC120V/60Hz
Environment:	25°C/58%	Engineer:	Roger
Remark:	power set: 6		
Test Standard:			

Start of Test: 2022-09-02 20:15:00

Test Graph

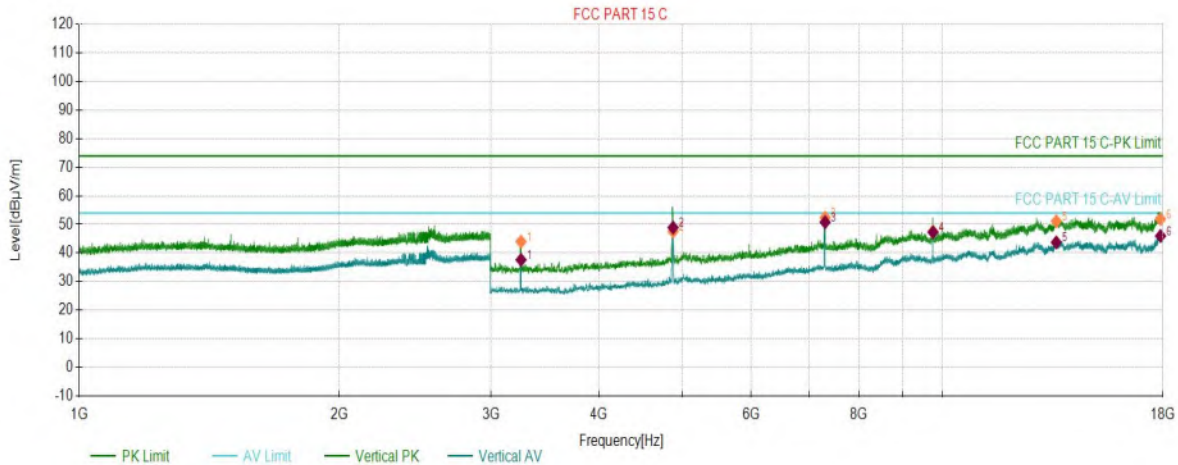

PK Final Data List

NO.	Freq. [MHz]	Factor [dB]	PK Value [dBµV/m]	PK Limit [dBµV/m]	PK Margin [dB]	Height [cm]	Angle [°]	Polarity
1	3249.0249	-16.00	44.00	74.00	30.00	150	245	Vertical
2	4873.6874	-9.55	47.56	74.00	26.44	150	190	Vertical
3	7309.9310	-1.33	52.42	74.00	21.58	150	166	Vertical
4	9747.6748	3.01	47.55	74.00	26.45	150	177	Vertical
5	13541.5542	10.53	51.12	74.00	22.88	150	38	Vertical
6	17878.4878	14.70	51.84	74.00	22.16	150	270	Vertical

AV Final Data List

NO.	Freq. [MHz]	Factor [dB]	AV Value [dBµV/m]	AV Limit [dBµV/m]	AV Margin [dB]	Height [cm]	Angle [°]	Polarity
1	3249.0249	-16.00	37.62	54.00	16.38	150	245	Vertical
2	4873.6874	-9.55	48.92	54.00	5.08	150	190	Vertical
3	7309.9310	-1.33	50.77	54.00	3.23	150	166	Vertical
4	9747.6748	3.01	47.26	54.00	6.74	150	177	Vertical
5	13541.5542	10.53	43.73	54.00	10.27	150	38	Vertical
6	17878.4878	14.70	45.98	54.00	8.02	150	270	Vertical

Test Report

Project Information			
Customer:		EUT:	PLUTO
Model:	SQPLUTO	SN:	
Mode:	11B_2462	Voltage:	AC120V/60Hz
Environment:	25°C/58%	Engineer:	Roger
Remark:	power set: 5		
Test Standard:			

Start of Test: 2022-09-02 20:18:29

Test Graph

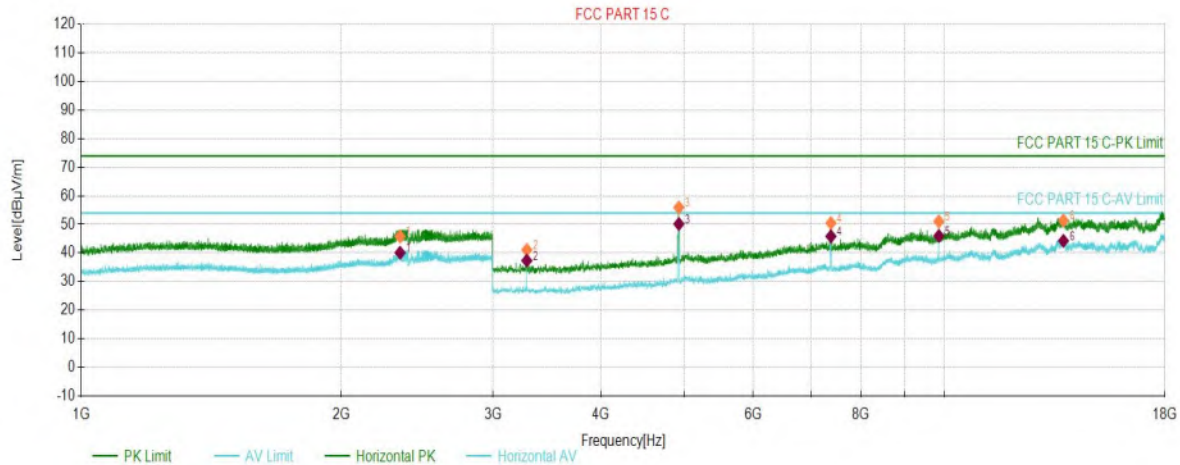

PK Final Data List

NO.	Freq. [MHz]	Factor [dB]	PK Value [dBµV/m]	PK Limit [dBµV/m]	PK Margin [dB]	Height [cm]	Angle [°]	Polarity
1	2340.7341	6.37	45.80	74.00	28.20	150	211	Horizontal
2	3282.0282	-15.97	41.12	74.00	32.88	150	288	Horizontal
3	4923.1923	-9.14	55.92	74.00	18.08	150	154	Horizontal
4	7384.9385	-1.82	50.49	74.00	23.51	150	246	Horizontal
5	9848.1848	3.57	51.06	74.00	22.94	150	186	Horizontal
6	13727.5728	10.98	51.39	74.00	22.61	150	31	Horizontal

AV Final Data List

NO.	Freq. [MHz]	Factor [dB]	AV Value [dBµV/m]	AV Limit [dBµV/m]	AV Margin [dB]	Height [cm]	Angle [°]	Polarity
1	2340.7341	6.37	40.12	54.00	13.88	150	211	Horizontal
2	3282.0282	-15.97	37.35	54.00	16.65	150	288	Horizontal
3	4923.1923	-9.14	50.16	54.00	3.84	150	154	Horizontal
4	7384.9385	-1.82	45.85	54.00	8.15	150	246	Horizontal
5	9848.1848	3.57	45.99	54.00	8.01	150	186	Horizontal
6	13727.5728	10.98	44.28	54.00	9.72	150	31	Horizontal

Test Report

Project Information			
Customer:		EUT:	PLUTO
Model:	SQPLUTO	SN:	
Mode:	11B_2462	Voltage:	AC120V/60Hz
Environment:	25°C/58%	Engineer:	Roger
Remark:	power set: 5		
Test Standard:			

Start of Test: 2022-09-02 20:20:12

Test Graph

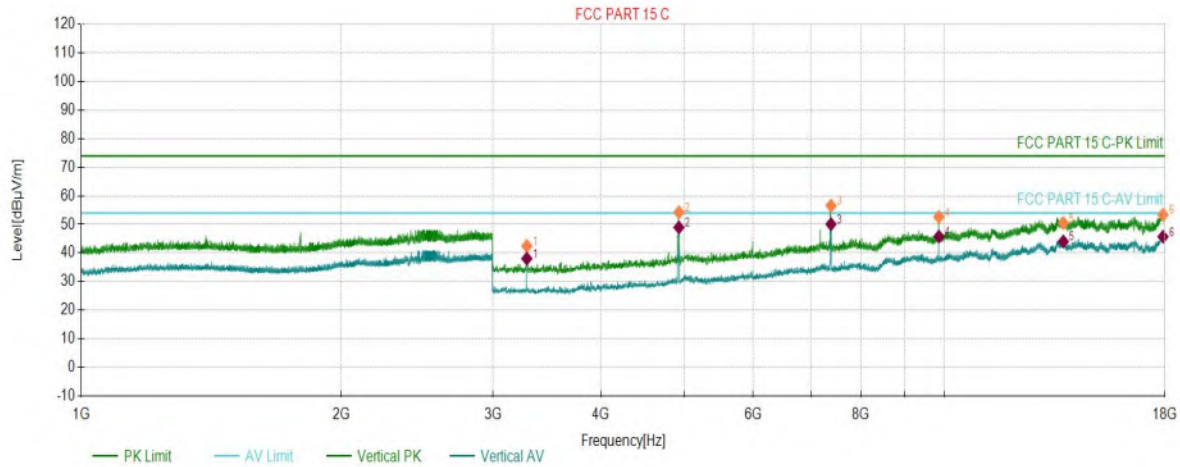

PK Final Data List

NO.	Freq. [MHz]	Factor [dB]	PK Value [dBµV/m]	PK Limit [dBµV/m]	PK Margin [dB]	Height [cm]	Angle [°]	Polarity
1	3282.0282	-15.97	42.47	74.00	31.53	150	224	Vertical
2	4923.1923	-9.14	54.27	74.00	19.73	150	34	Vertical
3	7386.4386	-1.83	56.56	74.00	17.44	150	241	Vertical
4	9848.1848	3.57	52.65	74.00	21.35	150	173	Vertical
5	13724.5725	11.02	50.50	74.00	23.50	150	265	Vertical
6	17902.4902	14.84	53.37	74.00	20.63	150	116	Vertical

AV Final Data List

NO.	Freq. [MHz]	Factor [dB]	AV Value [dBµV/m]	AV Limit [dBµV/m]	AV Margin [dB]	Height [cm]	Angle [°]	Polarity
1	3282.0282	-15.97	38.06	54.00	15.94	150	224	Vertical
2	4923.1923	-9.14	48.97	54.00	5.03	150	34	Vertical
3	7386.4386	-1.83	50.09	54.00	3.91	150	241	Vertical
4	9848.1848	3.57	45.77	54.00	8.23	150	173	Vertical
5	13724.5725	11.02	44.05	54.00	9.95	150	265	Vertical
6	17902.4902	14.84	45.71	54.00	8.29	150	116	Vertical

Test Report

Project Information			
Customer:		EUT:	PLUTO
Model:	SQPLUTO	SN:	
Mode:	11G_2412	Voltage:	AC120V/60Hz
Environment:	25°C/58%	Engineer:	Roger
Remark:	power set:		
Test Standard:			

Start of Test: 2022-09-02 20:32:35

Test Graph

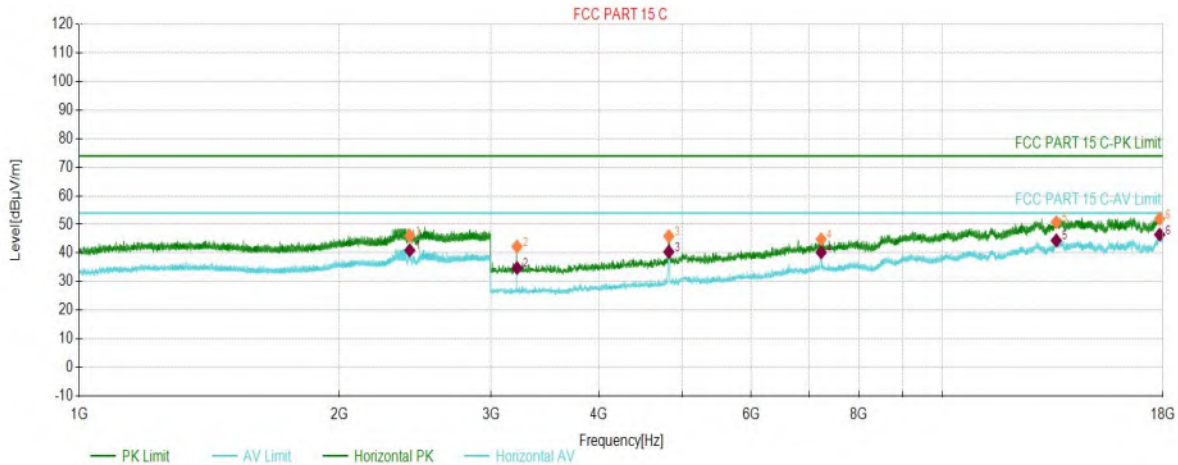

PK Final Data List

NO.	Freq. [MHz]	Factor [dB]	PK Value [dBµV/m]	PK Limit [dBµV/m]	PK Margin [dB]	Height [cm]	Angle [°]	Polarity
1	2414.9415	7.22	46.06	74.00	27.94	150	218	Horizontal
2	3214.5215	-16.03	42.27	74.00	31.73	150	58	Horizontal
3	4818.1818	-10.02	45.90	74.00	28.10	150	258	Horizontal
4	7233.4233	-1.52	44.83	74.00	29.17	150	209	Horizontal
5	13541.5542	10.53	50.79	74.00	23.21	150	209	Horizontal
6	17839.4839	14.41	51.94	74.00	22.06	150	252	Horizontal

AV Final Data List

NO.	Freq. [MHz]	Factor [dB]	AV Value [dBµV/m]	AV Limit [dBµV/m]	AV Margin [dB]	Height [cm]	Angle [°]	Polarity
1	2414.9415	7.22	40.95	54.00	13.05	150	218	Horizontal
2	3214.5215	-16.03	34.78	54.00	19.22	150	58	Horizontal
3	4818.1818	-10.02	40.40	54.00	13.60	150	258	Horizontal
4	7233.4233	-1.52	40.22	54.00	13.78	150	209	Horizontal
5	13541.5542	10.53	44.40	54.00	9.60	150	209	Horizontal
6	17839.4839	14.41	46.45	54.00	7.55	150	252	Horizontal

Test Report

Project Information			
Customer:		EUT:	PLUTO
Model:	SQPLUTO	SN:	
Mode:	11G_2412	Voltage:	AC120V/60Hz
Environment:	25°C/58%	Engineer:	Roger
Remark:	power set: 0		
Test Standard:			

Start of Test: 2022-09-02 20:34:20

Test Graph

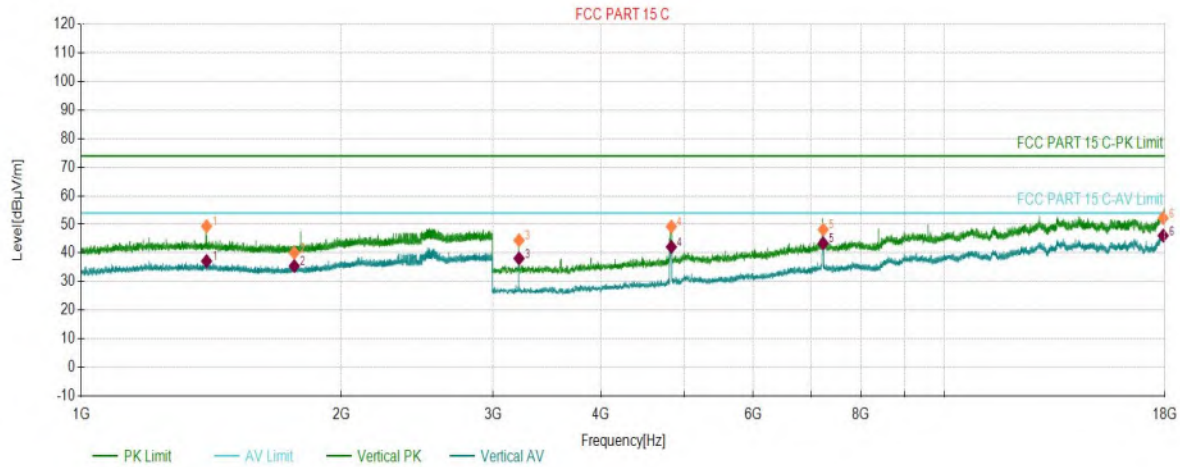

PK Final Data List

NO.	Freq. [MHz]	Factor [dB]	PK Value [dBµV/m]	PK Limit [dBµV/m]	PK Margin [dB]	Height [cm]	Angle [°]	Polarity
1	1397.2397	3.45	49.38	74.00	24.62	150	92	Vertical
2	1765.4765	3.31	40.11	74.00	33.89	150	319	Vertical
3	3214.5215	-16.03	44.47	74.00	29.53	150	243	Vertical
4	4825.6826	-9.95	49.26	74.00	24.74	150	186	Vertical
5	7233.4233	-1.52	48.19	74.00	25.81	150	161	Vertical
6	17911.4911	14.79	52.24	74.00	21.76	150	161	Vertical

AV Final Data List

NO.	Freq. [MHz]	Factor [dB]	AV Value [dBµV/m]	AV Limit [dBµV/m]	AV Margin [dB]	Height [cm]	Angle [°]	Polarity
1	1397.2397	3.45	37.18	54.00	16.82	150	92	Vertical
2	1765.4765	3.31	35.47	54.00	18.53	150	319	Vertical
3	3214.5215	-16.03	38.12	54.00	15.88	150	243	Vertical
4	4825.6826	-9.95	42.16	54.00	11.84	150	186	Vertical
5	7233.4233	-1.52	43.40	54.00	10.60	150	161	Vertical
6	17911.4911	14.79	46.09	54.00	7.91	150	161	Vertical

Test Report

Project Information			
Customer:		EUT:	PLUTO
Model:	SQPLUTO	SN:	
Mode:	11G_2437	Voltage:	AC120V/60Hz
Environment:	25°C/58%	Engineer:	Roger
Remark:	power set: 0		
Test Standard:			

Start of Test: 2022-09-02 20:37:11

Test Graph

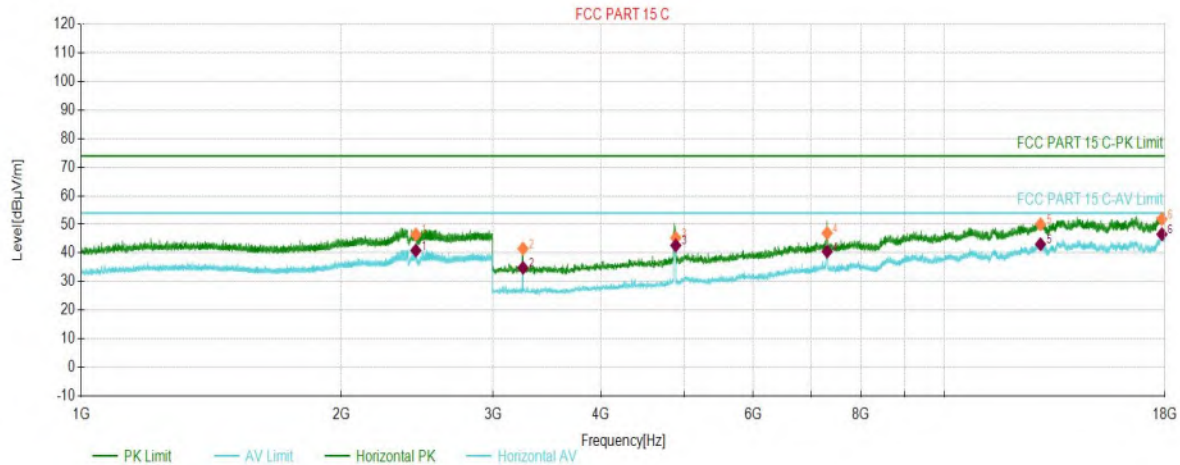

PK Final Data List

NO.	Freq. [MHz]	Factor [dB]	PK Value [dBµV/m]	PK Limit [dBµV/m]	PK Margin [dB]	Height [cm]	Angle [°]	Polarity
1	2441.5442	7.41	46.48	74.00	27.52	150	221	Horizontal
2	3249.0249	-16.00	41.53	74.00	32.47	150	283	Horizontal
3	4882.6883	-9.48	45.29	74.00	28.71	150	120	Horizontal
4	7311.4311	-1.34	46.96	74.00	27.04	150	226	Horizontal
5	12914.4914	9.51	50.06	74.00	23.94	150	200	Horizontal
6	17849.9850	14.49	51.88	74.00	22.12	150	157	Horizontal

AV Final Data List

NO.	Freq. [MHz]	Factor [dB]	AV Value [dBµV/m]	AV Limit [dBµV/m]	AV Margin [dB]	Height [cm]	Angle [°]	Polarity
1	2441.5442	7.41	40.89	54.00	13.11	150	221	Horizontal
2	3249.0249	-16.00	34.84	54.00	19.16	150	283	Horizontal
3	4882.6883	-9.48	42.68	54.00	11.32	150	120	Horizontal
4	7311.4311	-1.34	40.53	54.00	13.47	150	226	Horizontal
5	12914.4914	9.51	43.09	54.00	10.91	150	200	Horizontal
6	17849.9850	14.49	46.57	54.00	7.43	150	157	Horizontal

Test Report

Project Information			
Customer:		EUT:	PLUTO
Model:	SQPLUTO	SN:	
Mode:	11G_2437	Voltage:	AC120V/60Hz
Environment:	25°C/58%	Engineer:	Roger
Remark:	power set: 0		
Test Standard:			

Start of Test: 2022-09-02 20:38:55

Test Graph

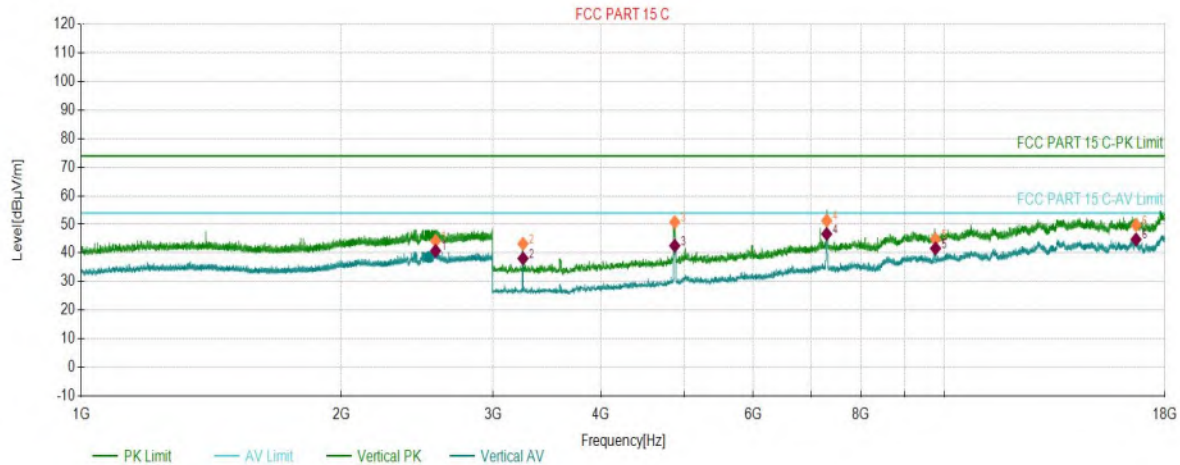

PK Final Data List

NO.	Freq. [MHz]	Factor [dB]	PK Value [dBµV/m]	PK Limit [dBµV/m]	PK Margin [dB]	Height [cm]	Angle [°]	Polarity
1	2573.3573	7.34	44.26	74.00	29.74	150	197	Vertical
2	3249.0249	-16.00	43.26	74.00	30.74	150	245	Vertical
3	4869.1869	-9.59	50.83	74.00	23.17	150	182	Vertical
4	7302.4302	-1.28	51.31	74.00	22.69	150	159	Vertical
5	9759.6760	3.08	44.84	74.00	29.16	150	171	Vertical
6	16661.8662	11.21	49.75	74.00	24.25	150	128	Vertical

AV Final Data List

NO.	Freq. [MHz]	Factor [dB]	AV Value [dBµV/m]	AV Limit [dBµV/m]	AV Margin [dB]	Height [cm]	Angle [°]	Polarity
1	2573.3573	7.34	40.78	54.00	13.22	150	197	Vertical
2	3249.0249	-16.00	38.11	54.00	15.89	150	245	Vertical
3	4869.1869	-9.59	42.54	54.00	11.46	150	182	Vertical
4	7302.4302	-1.28	46.68	54.00	7.32	150	159	Vertical
5	9759.6760	3.08	41.61	54.00	12.39	150	171	Vertical
6	16661.8662	11.21	44.76	54.00	9.24	150	128	Vertical

Test Report

Project Information			
Customer:		EUT:	PLUTO
Model:	SQPLUTO	SN:	
Mode:	11G_2462	Voltage:	AC120V/60Hz
Environment:	25°C/58%	Engineer:	Roger
Remark:	power set: 0		
Test Standard:			

Start of Test: 2022-09-02 20:44:14

Test Graph

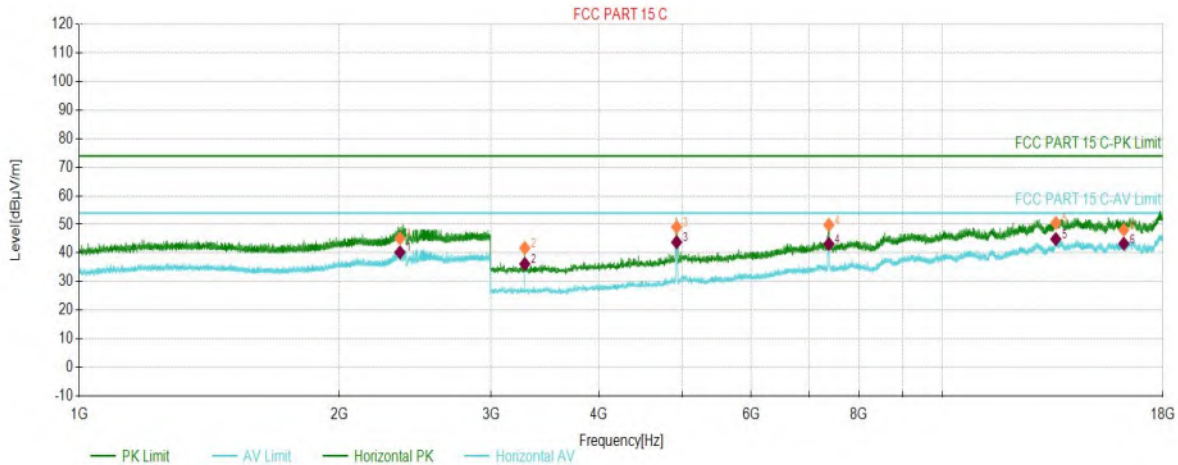

PK Final Data List

NO.	Freq. [MHz]	Factor [dB]	PK Value [dBµV/m]	PK Limit [dBµV/m]	PK Margin [dB]	Height [cm]	Angle [°]	Polarity
1	2352.5353	6.43	45.09	74.00	28.91	150	197	Horizontal
2	3282.0282	-15.97	41.76	74.00	32.24	150	283	Horizontal
3	4920.1920	-9.16	49.13	74.00	24.87	150	150	Horizontal
4	7383.4383	-1.81	49.85	74.00	24.15	150	238	Horizontal
5	13525.0525	10.57	50.51	74.00	23.49	150	104	Horizontal
6	16210.3210	10.68	48.11	74.00	25.89	150	168	Horizontal

AV Final Data List

NO.	Freq. [MHz]	Factor [dB]	AV Value [dBµV/m]	AV Limit [dBµV/m]	AV Margin [dB]	Height [cm]	Angle [°]	Polarity
1	2352.5353	6.43	40.26	54.00	13.74	150	197	Horizontal
2	3282.0282	-15.97	36.19	54.00	17.81	150	283	Horizontal
3	4920.1920	-9.16	43.79	54.00	10.21	150	150	Horizontal
4	7383.4383	-1.81	43.18	54.00	10.82	150	238	Horizontal
5	13525.0525	10.57	44.88	54.00	9.12	150	104	Horizontal
6	16210.3210	10.68	43.29	54.00	10.71	150	168	Horizontal

Test Report

Project Information			
Customer:		EUT:	PLUTO
Model:	SQPLUTO	SN:	
Mode:	11G_2462	Voltage:	AC120V/60Hz
Environment:	25°C/58%	Engineer:	Roger
Remark:	power set: 0		
Test Standard:			

Start of Test: 2022-09-02 20:45:57

Test Graph

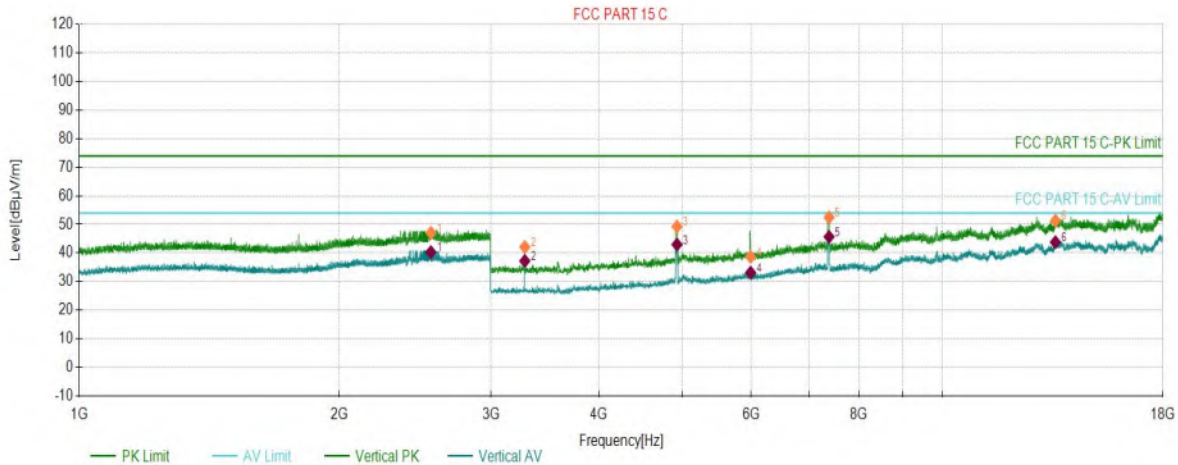

PK Final Data List

NO.	Freq. [MHz]	Factor [dB]	PK Value [dBµV/m]	PK Limit [dBµV/m]	PK Margin [dB]	Height [cm]	Angle [°]	Polarity
1	2554.7555	7.50	47.07	74.00	26.93	150	200	Vertical
2	3282.0282	-15.97	42.10	74.00	31.90	150	243	Vertical
3	4924.6925	-9.13	49.26	74.00	24.74	150	27	Vertical
4	5992.7993	-6.18	38.68	74.00	35.32	150	157	Vertical
5	7387.9388	-1.84	52.48	74.00	21.52	150	176	Vertical
6	13510.0510	10.61	51.31	74.00	22.69	150	194	Vertical

AV Final Data List

NO.	Freq. [MHz]	Factor [dB]	AV Value [dBµV/m]	AV Limit [dBµV/m]	AV Margin [dB]	Height [cm]	Angle [°]	Polarity
1	2554.7555	7.50	40.32	54.00	13.68	150	200	Vertical
2	3282.0282	-15.97	37.24	54.00	16.76	150	243	Vertical
3	4924.6925	-9.13	42.98	54.00	11.02	150	27	Vertical
4	5992.7993	-6.18	33.16	54.00	20.84	150	157	Vertical
5	7387.9388	-1.84	45.68	54.00	8.32	150	176	Vertical
6	13510.0510	10.61	43.80	54.00	10.20	150	194	Vertical

Test Report

Project Information			
Customer:		EUT:	PLUTO
Model:	SQPLUTO	SN:	
Mode:	11N20_2412	Voltage:	AC120V/60Hz
Environment:	25°C/58%	Engineer:	Roger
Remark:	power set: 0		
Test Standard:			

Start of Test: 2022-09-02 20:48:29

Test Graph

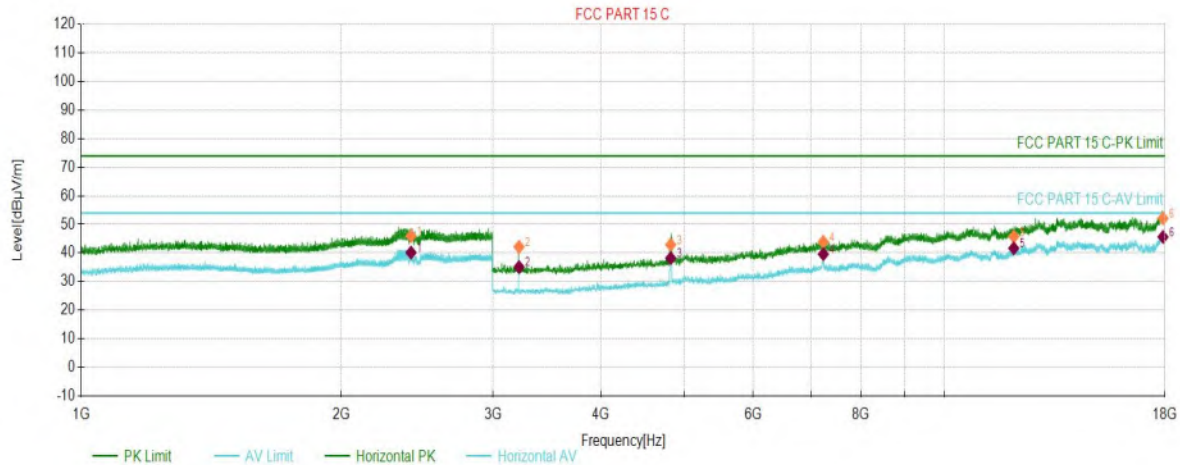

PK Final Data List

NO.	Freq. [MHz]	Factor [dB]	PK Value [dBµV/m]	PK Limit [dBµV/m]	PK Margin [dB]	Height [cm]	Angle [°]	Polarity
1	2410.3410	7.19	45.95	74.00	28.05	150	196	Horizontal
2	3214.5215	-16.03	42.17	74.00	31.83	150	277	Horizontal
3	4816.6817	-10.03	42.93	74.00	31.07	150	159	Horizontal
4	7236.4236	-1.51	43.91	74.00	30.09	150	208	Horizontal
5	12024.9025	5.76	45.75	74.00	28.25	150	108	Horizontal
6	17902.4902	14.84	52.10	74.00	21.90	150	0	Horizontal

AV Final Data List

NO.	Freq. [MHz]	Factor [dB]	AV Value [dBµV/m]	AV Limit [dBµV/m]	AV Margin [dB]	Height [cm]	Angle [°]	Polarity
1	2410.3410	7.19	40.17	54.00	13.83	150	196	Horizontal
2	3214.5215	-16.03	35.10	54.00	18.90	150	277	Horizontal
3	4816.6817	-10.03	38.21	54.00	15.79	150	159	Horizontal
4	7236.4236	-1.51	39.60	54.00	14.40	150	208	Horizontal
5	12024.9025	5.76	41.69	54.00	12.31	150	108	Horizontal
6	17902.4902	14.84	45.62	54.00	8.38	150	0	Horizontal

Test Report

Project Information			
Customer:		EUT:	PLUTO
Model:	SQPLUTO	SN:	
Mode:	11N20_2412	Voltage:	AC120V/60Hz
Environment:	25°C/58%	Engineer:	Roger
Remark:	power set: 0		
Test Standard:			

Start of Test: 2022-09-02 20:50:13

Test Graph

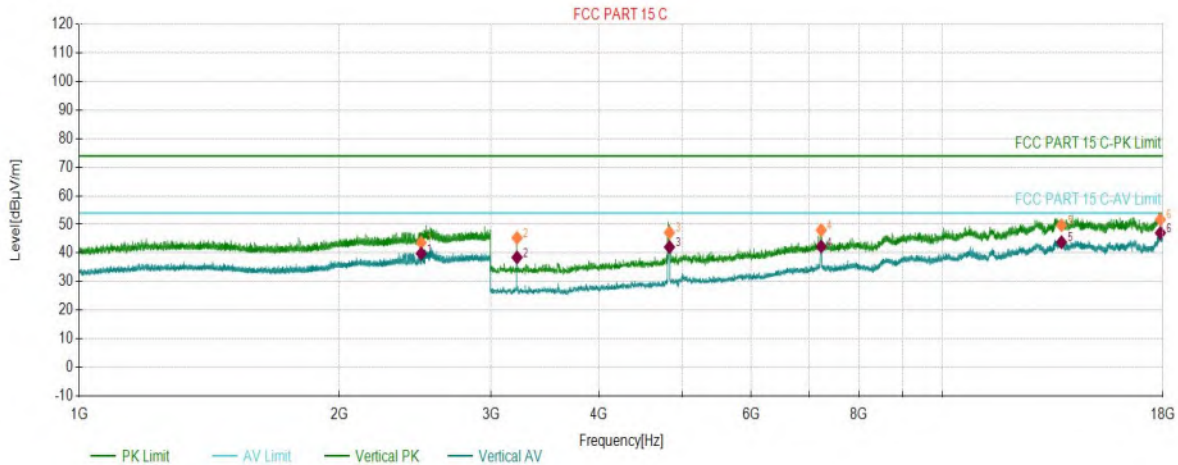

PK Final Data List

NO.	Freq. [MHz]	Factor [dB]	PK Value [dBµV/m]	PK Limit [dBµV/m]	PK Margin [dB]	Height [cm]	Angle [°]	Polarity
1	2489.7490	7.74	43.62	74.00	30.38	150	127	Vertical
2	3214.5215	-16.03	45.29	74.00	28.71	150	244	Vertical
3	4827.1827	-9.94	47.17	74.00	26.83	150	189	Vertical
4	7234.9235	-1.51	48.04	74.00	25.96	150	163	Vertical
5	13729.0729	10.96	49.71	74.00	24.29	150	238	Vertical
6	17873.9874	14.66	51.71	74.00	22.29	150	62	Vertical

AV Final Data List

NO.	Freq. [MHz]	Factor [dB]	AV Value [dBµV/m]	AV Limit [dBµV/m]	AV Margin [dB]	Height [cm]	Angle [°]	Polarity
1	2489.7490	7.74	39.83	54.00	14.17	150	127	Vertical
2	3214.5215	-16.03	38.47	54.00	15.53	150	244	Vertical
3	4827.1827	-9.94	42.09	54.00	11.91	150	189	Vertical
4	7234.9235	-1.51	42.28	54.00	11.72	150	163	Vertical
5	13729.0729	10.96	43.81	54.00	10.19	150	238	Vertical
6	17873.9874	14.66	47.03	54.00	6.97	150	62	Vertical

Test Report

Project Information			
Customer:		EUT:	PLUTO
Model:	SQPLUTO	SN:	
Mode:	11N20_2437	Voltage:	AC120V/60Hz
Environment:	25°C/58%	Engineer:	Roger
Remark:	power set: 0		
Test Standard:			

Start of Test: 2022-09-02 20:52:30

Test Graph

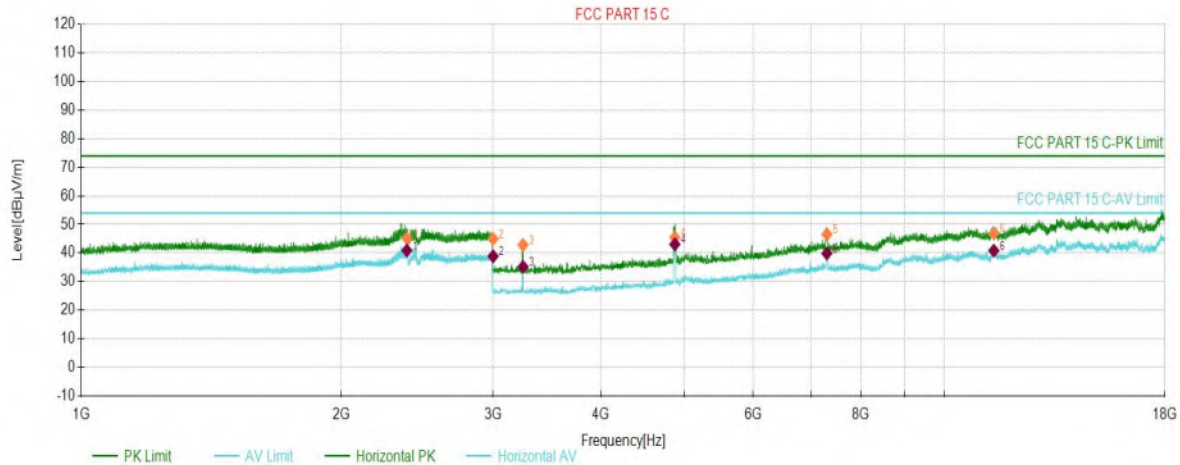

PK Final Data List

NO.	Freq. [MHz]	Factor [dB]	PK Value [dBµV/m]	PK Limit [dBµV/m]	PK Margin [dB]	Height [cm]	Angle [°]	Polarity
1	2383.7384	6.62	45.19	74.00	28.81	150	221	Horizontal
2	3000.0000	8.86	44.96	74.00	29.04	150	353	Horizontal
3	3249.0249	-16.00	42.83	74.00	31.17	150	255	Horizontal
4	4870.6871	-9.58	45.45	74.00	28.55	150	116	Horizontal
5	7305.4305	-1.30	46.57	74.00	27.43	150	174	Horizontal
6	11402.3402	6.05	46.85	74.00	27.15	150	174	Horizontal

AV Final Data List

NO.	Freq. [MHz]	Factor [dB]	AV Value [dBµV/m]	AV Limit [dBµV/m]	AV Margin [dB]	Height [cm]	Angle [°]	Polarity
1	2383.7384	6.62	40.91	54.00	13.09	150	221	Horizontal
2	3000.0000	8.86	38.87	54.00	15.13	150	353	Horizontal
3	3249.0249	-16.00	35.21	54.00	18.79	150	255	Horizontal
4	4870.6871	-9.58	43.06	54.00	10.94	150	116	Horizontal
5	7305.4305	-1.30	39.88	54.00	14.12	150	174	Horizontal
6	11402.3402	6.05	40.84	54.00	13.16	150	174	Horizontal

Test Report

Project Information			
Customer:		EUT:	PLUTO
Model:	SQPLUTO	SN:	
Mode:	11N20_2437	Voltage:	AC120V/60Hz
Environment:	25°C/58%	Engineer:	Roger
Remark:	power set: 0		
Test Standard:			

Start of Test: 2022-09-02 20:54:14

Test Graph

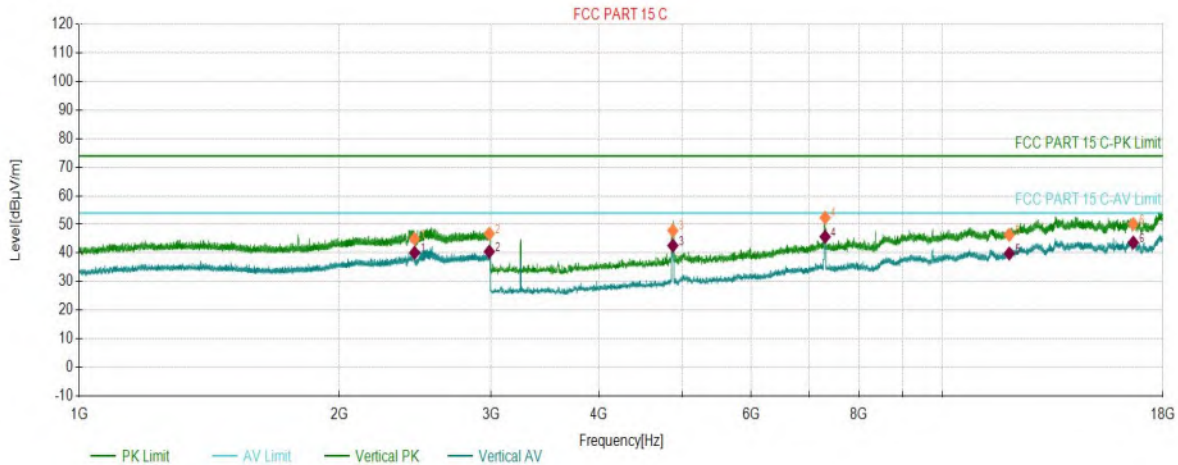

PK Final Data List

NO.	Freq. [MHz]	Factor [dB]	PK Value [dBµV/m]	PK Limit [dBµV/m]	PK Margin [dB]	Height [cm]	Angle [°]	Polarity
1	2446.1446	7.44	45.00	74.00	29.00	150	166	Vertical
2	2985.3985	8.79	46.78	74.00	27.22	150	129	Vertical
3	4870.6871	-9.58	47.86	74.00	26.14	150	184	Vertical
4	7309.9310	-1.33	52.36	74.00	21.64	150	240	Vertical
5	11945.3945	5.33	46.36	74.00	27.64	150	111	Vertical
6	16628.8629	11.14	50.15	74.00	23.85	150	173	Vertical

AV Final Data List

NO.	Freq. [MHz]	Factor [dB]	AV Value [dBµV/m]	AV Limit [dBµV/m]	AV Margin [dB]	Height [cm]	Angle [°]	Polarity
1	2446.1446	7.44	40.13	54.00	13.87	150	166	Vertical
2	2985.3985	8.79	40.50	54.00	13.50	150	129	Vertical
3	4870.6871	-9.58	42.61	54.00	11.39	150	184	Vertical
4	7309.9310	-1.33	45.70	54.00	8.30	150	240	Vertical
5	11945.3945	5.33	39.84	54.00	14.16	150	111	Vertical
6	16628.8629	11.14	43.69	54.00	10.31	150	173	Vertical

Test Report

Project Information			
Customer:		EUT:	PLUTO
Model:	SQPLUTO	SN:	
Mode:	11N20_2462	Voltage:	AC120V/60Hz
Environment:	25°C/58%	Engineer:	Roger
Remark:	power set: 0		
Test Standard:			

Start of Test: 2022-09-03 09:40:11

Test Graph

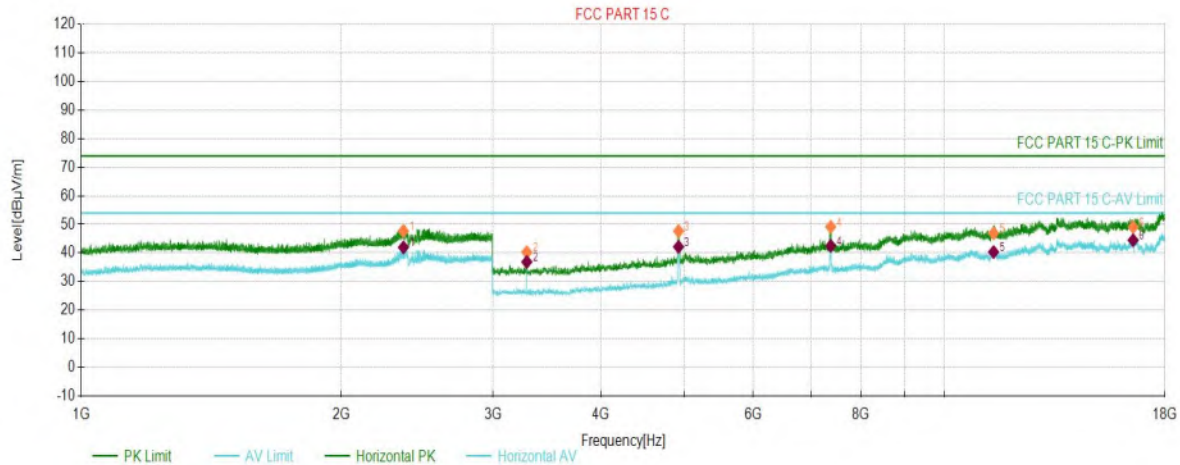

PK Final Data List

NO.	Freq. [MHz]	Factor [dB]	PK Value [dBµV/m]	PK Limit [dBµV/m]	PK Margin [dB]	Height [cm]	Angle [°]	Polarity
1	2361.9362	6.49	47.72	74.00	26.28	150	217	Horizontal
2	3282.0282	-15.97	40.28	74.00	33.72	150	279	Horizontal
3	4918.6919	-9.17	47.67	74.00	26.33	150	137	Horizontal
4	7380.4380	-1.79	49.16	74.00	24.84	150	239	Horizontal
5	11394.8395	6.00	46.93	74.00	27.07	150	239	Horizontal
6	16534.3534	11.61	49.09	74.00	24.91	150	222	Horizontal

AV Final Data List

NO.	Freq. [MHz]	Factor [dB]	AV Value [dBµV/m]	AV Limit [dBµV/m]	AV Margin [dB]	Height [cm]	Angle [°]	Polarity
1	2361.9362	6.49	42.00	54.00	12.00	150	217	Horizontal
2	3282.0282	-15.97	36.90	54.00	17.10	150	279	Horizontal
3	4918.6919	-9.17	42.19	54.00	11.81	150	137	Horizontal
4	7380.4380	-1.79	42.53	54.00	11.47	150	239	Horizontal
5	11394.8395	6.00	40.36	54.00	13.64	150	239	Horizontal
6	16534.3534	11.61	44.49	54.00	9.51	150	222	Horizontal

Test Report

Project Information			
Customer:		EUT:	PLUTO
Model:	SQPLUTO	SN:	
Mode:	11N20_2462	Voltage:	AC120V/60Hz
Environment:	25°C/58%	Engineer:	Roger
Remark:	power set: 0		
Test Standard:			

Start of Test: 2022-09-03 09:41:37

Test Graph

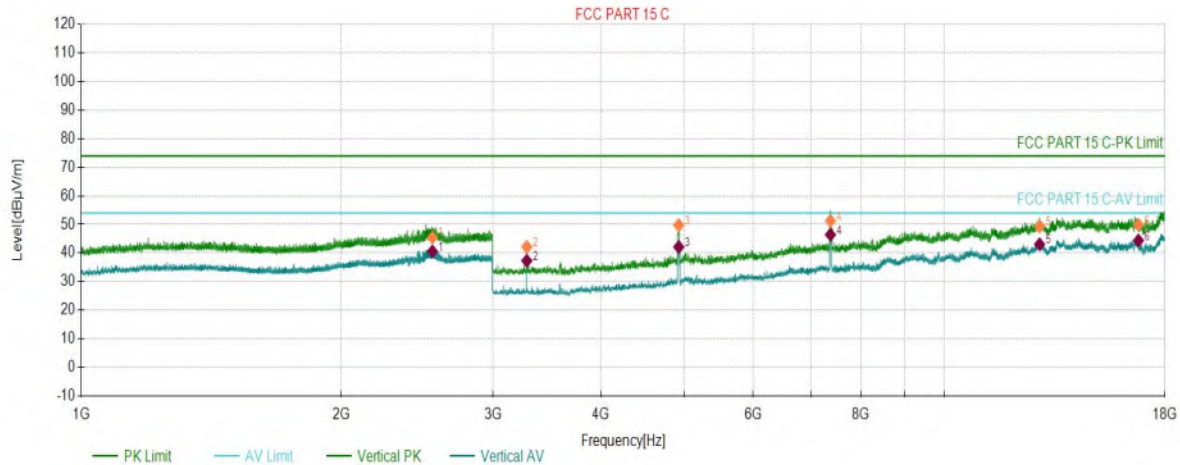

PK Final Data List

NO.	Freq. [MHz]	Factor [dB]	PK Value [dBµV/m]	PK Limit [dBµV/m]	PK Margin [dB]	Height [cm]	Angle [°]	Polarity
1	2551.5552	7.53	45.42	74.00	28.58	150	198	Vertical
2	3282.0282	-15.97	42.14	74.00	31.86	150	223	Vertical
3	4921.6922	-9.15	49.74	74.00	24.26	150	196	Vertical
4	7375.9376	-1.76	51.25	74.00	22.75	150	172	Vertical
5	12882.9883	9.48	49.28	74.00	24.72	150	172	Vertical
6	16766.8767	10.88	49.84	74.00	24.16	150	156	Vertical

AV Final Data List

NO.	Freq. [MHz]	Factor [dB]	AV Value [dBµV/m]	AV Limit [dBµV/m]	AV Margin [dB]	Height [cm]	Angle [°]	Polarity
1	2551.5552	7.53	40.58	54.00	13.42	150	198	Vertical
2	3282.0282	-15.97	37.32	54.00	16.68	150	223	Vertical
3	4921.6922	-9.15	42.14	54.00	11.86	150	196	Vertical
4	7375.9376	-1.76	46.42	54.00	7.58	150	172	Vertical
5	12882.9883	9.48	43.05	54.00	10.95	150	172	Vertical
6	16766.8767	10.88	44.38	54.00	9.62	150	156	Vertical

Test Report

Project Information			
Customer:		EUT:	PLUTO
Model:	SQPLUTO	SN:	
Mode:	11N40_2422	Voltage:	AC120V/60Hz
Environment:	25°C/58%	Engineer:	Roger
Remark:	power set: 0		
Test Standard:			

Start of Test: 2022-09-03 09:44:08

Test Graph

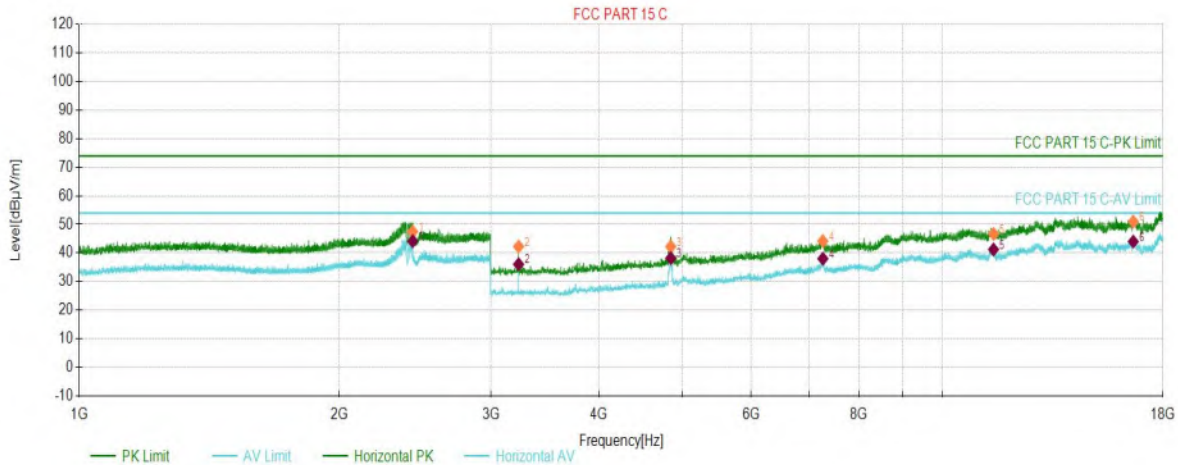

PK Final Data List

NO.	Freq. [MHz]	Factor [dB]	PK Value [dBµV/m]	PK Limit [dBµV/m]	PK Margin [dB]	Height [cm]	Angle [°]	Polarity
1	2433.7434	7.35	47.48	74.00	26.52	150	224	Horizontal
2	3228.0228	-16.01	42.28	74.00	31.72	150	280	Horizontal
3	4843.6844	-9.80	42.28	74.00	31.72	150	116	Horizontal
4	7266.4266	-1.39	44.20	74.00	29.80	150	237	Horizontal
5	11454.8455	5.68	46.67	74.00	27.33	150	99	Horizontal
6	16627.3627	11.13	50.97	74.00	23.03	150	107	Horizontal

AV Final Data List

NO.	Freq. [MHz]	Factor [dB]	AV Value [dBµV/m]	AV Limit [dBµV/m]	AV Margin [dB]	Height [cm]	Angle [°]	Polarity
1	2433.7434	7.35	44.13	54.00	9.87	150	224	Horizontal
2	3228.0228	-16.01	36.09	54.00	17.91	150	280	Horizontal
3	4843.6844	-9.80	38.19	54.00	15.81	150	116	Horizontal
4	7266.4266	-1.39	38.04	54.00	15.96	150	237	Horizontal
5	11454.8455	5.68	41.26	54.00	12.74	150	99	Horizontal
6	16627.3627	11.13	44.02	54.00	9.98	150	107	Horizontal

Test Report

Project Information			
Customer:		EUT:	PLUTO
Model:	SQPLUTO	SN:	
Mode:	11N40_2422	Voltage:	AC120V/60Hz
Environment:	25°C/58%	Engineer:	Roger
Remark:	power set: 0		
Test Standard:			

Start of Test: 2022-09-03 09:45:34

Test Graph

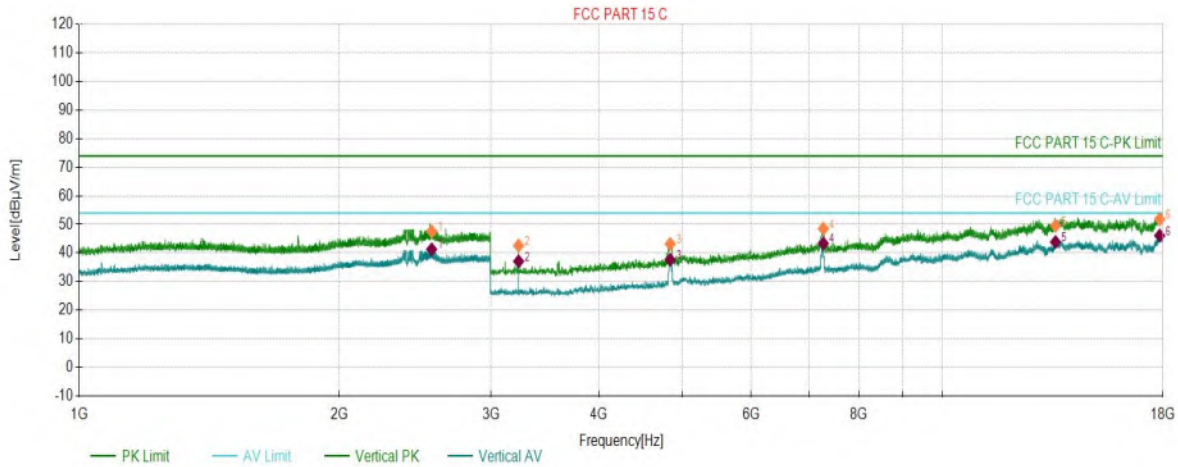

PK Final Data List

NO.	Freq. [MHz]	Factor [dB]	PK Value [dBµV/m]	PK Limit [dBµV/m]	PK Margin [dB]	Height [cm]	Angle [°]	Polarity
1	2560.1560	7.46	47.56	74.00	26.44	150	204	Vertical
2	3228.0228	-16.01	42.60	74.00	31.40	150	242	Vertical
3	4836.1836	-9.87	43.19	74.00	30.81	150	183	Vertical
4	7276.9277	-1.35	48.53	74.00	25.47	150	158	Vertical
5	13513.0513	10.60	49.53	74.00	24.47	150	2	Vertical
6	17840.9841	14.43	51.81	74.00	22.19	150	286	Vertical

AV Final Data List

NO.	Freq. [MHz]	Factor [dB]	AV Value [dBµV/m]	AV Limit [dBµV/m]	AV Margin [dB]	Height [cm]	Angle [°]	Polarity
1	2560.1560	7.46	41.31	54.00	12.69	150	204	Vertical
2	3228.0228	-16.01	37.11	54.00	16.89	150	242	Vertical
3	4836.1836	-9.87	37.64	54.00	16.36	150	183	Vertical
4	7276.9277	-1.35	43.35	54.00	10.65	150	158	Vertical
5	13513.0513	10.60	43.86	54.00	10.14	150	2	Vertical
6	17840.9841	14.43	46.10	54.00	7.90	150	286	Vertical

Test Report

Project Information			
Customer:		EUT:	PLUTO
Model:	SQPLUTO	SN:	
Mode:	11N40_2437	Voltage:	AC120V/60Hz
Environment:	25°C/58%	Engineer:	Roger
Remark:	power set: 0		
Test Standard:			

Start of Test: 2022-09-03 09:47:36

Test Graph

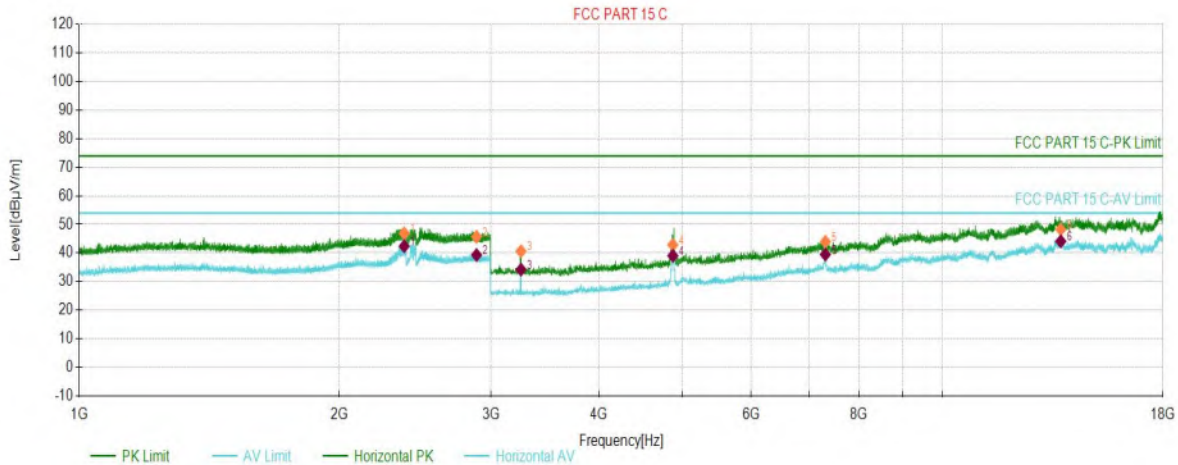

PK Final Data List

NO.	Freq. [MHz]	Factor [dB]	PK Value [dBµV/m]	PK Limit [dBµV/m]	PK Margin [dB]	Height [cm]	Angle [°]	Polarity
1	2379.1379	6.53	46.92	74.00	27.08	150	222	Horizontal
2	2885.5886	8.31	45.70	74.00	28.30	150	308	Horizontal
3	3249.0249	-16.00	40.65	74.00	33.35	150	274	Horizontal
4	4870.6871	-9.58	42.86	74.00	31.14	150	118	Horizontal
5	7314.4314	-1.36	43.95	74.00	30.05	150	222	Horizontal
6	13703.5704	11.32	48.28	74.00	25.72	150	101	Horizontal

AV Final Data List

NO.	Freq. [MHz]	Factor [dB]	AV Value [dBµV/m]	AV Limit [dBµV/m]	AV Margin [dB]	Height [cm]	Angle [°]	Polarity
1	2379.1379	6.53	42.40	54.00	11.60	150	222	Horizontal
2	2885.5886	8.31	39.31	54.00	14.69	150	308	Horizontal
3	3249.0249	-16.00	34.22	54.00	19.78	150	274	Horizontal
4	4870.6871	-9.58	39.06	54.00	14.94	150	118	Horizontal
5	7314.4314	-1.36	39.49	54.00	14.51	150	222	Horizontal
6	13703.5704	11.32	44.10	54.00	9.90	150	101	Horizontal

Test Report

Project Information			
Customer:		EUT:	PLUTO
Model:	SQPLUTO	SN:	
Mode:	11N40_2437	Voltage:	AC120V/60Hz
Environment:	25°C/58%	Engineer:	Roger
Remark:	power set: 0		
Test Standard:			

Start of Test: 2022-09-03 09:49:03

Test Graph

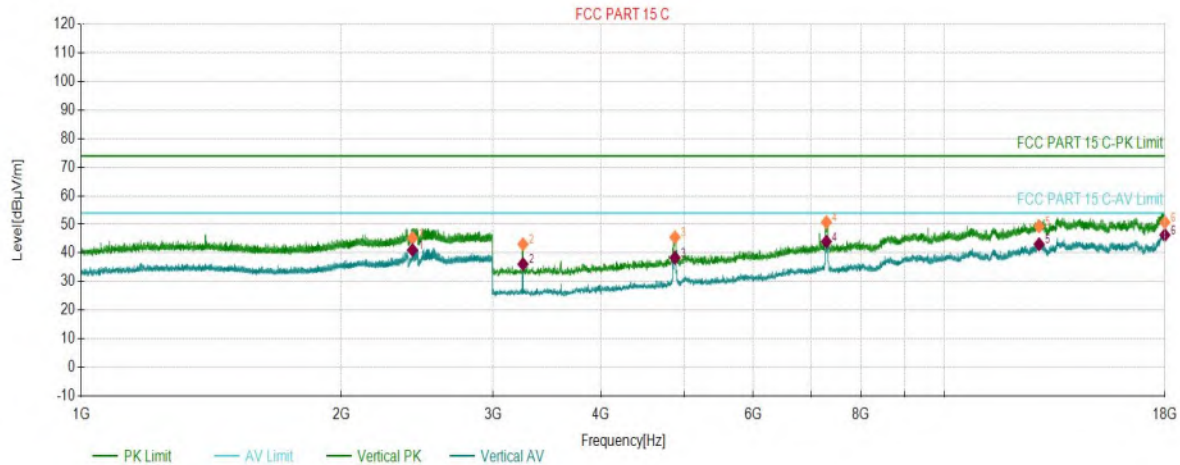

PK Final Data List

NO.	Freq. [MHz]	Factor [dB]	PK Value [dBµV/m]	PK Limit [dBµV/m]	PK Margin [dB]	Height [cm]	Angle [°]	Polarity
1	2419.9420	7.26	45.29	74.00	28.71	150	170	Vertical
2	3249.0249	-16.00	43.10	74.00	30.90	150	242	Vertical
3	4872.1872	-9.56	45.52	74.00	28.48	150	184	Vertical
4	7296.4296	-1.27	50.75	74.00	23.25	150	158	Vertical
5	12866.4866	9.46	49.30	74.00	24.70	150	358	Vertical
6	17992.4993	14.41	50.75	74.00	23.25	150	166	Vertical

AV Final Data List

NO.	Freq. [MHz]	Factor [dB]	AV Value [dBµV/m]	AV Limit [dBµV/m]	AV Margin [dB]	Height [cm]	Angle [°]	Polarity
1	2419.9420	7.26	41.04	54.00	12.96	150	170	Vertical
2	3249.0249	-16.00	36.15	54.00	17.85	150	242	Vertical
3	4872.1872	-9.56	38.38	54.00	15.62	150	184	Vertical
4	7296.4296	-1.27	44.00	54.00	10.00	150	158	Vertical
5	12866.4866	9.46	43.07	54.00	10.93	150	358	Vertical
6	17992.4993	14.41	46.31	54.00	7.69	150	166	Vertical

Test Report

Project Information			
Customer:		EUT:	PLUTO
Model:	SQPLUTO	SN:	
Mode:	11N40_2452	Voltage:	AC120V/60Hz
Environment:	25°C/58%	Engineer:	Roger
Remark:	power set: 0		
Test Standard:			

Start of Test: 2022-09-03 09:51:41

Test Graph



PK Final Data List

NO.	Freq. [MHz]	Factor [dB]	PK Value [dBµV/m]	PK Limit [dBµV/m]	PK Margin [dB]	Height [cm]	Angle [°]	Polarity
1	2387.7388	6.69	47.35	74.00	26.65	150	221	Horizontal
2	3268.5269	-15.98	33.93	74.00	40.07	150	330	Horizontal
3	4903.6904	-9.30	43.34	74.00	30.66	150	146	Horizontal
4	7350.4350	-1.59	46.00	74.00	28.00	150	164	Horizontal
5	12887.4887	9.49	48.30	74.00	25.70	150	252	Horizontal
6	17882.9883	14.73	53.73	74.00	20.27	150	190	Horizontal

AV Final Data List

NO.	Freq. [MHz]	Factor [dB]	AV Value [dBµV/m]	AV Limit [dBµV/m]	AV Margin [dB]	Height [cm]	Angle [°]	Polarity
1	2387.7388	6.69	41.69	54.00	12.31	150	221	Horizontal
2	3268.5269	-15.98	35.18	54.00	18.82	150	330	Horizontal
3	4903.6904	-9.30	40.53	54.00	13.47	150	146	Horizontal
4	7350.4350	-1.59	39.93	54.00	14.07	150	164	Horizontal
5	12887.4887	9.49	43.13	54.00	10.87	150	252	Horizontal
6	17882.9883	14.73	46.28	54.00	7.72	150	190	Horizontal

Test Report

Project Information			
Customer:		EUT:	PLUTO
Model:	SQPLUTO	SN:	
Mode:	11N40_2452	Voltage:	AC120V/60Hz
Environment:	25°C/58%	Engineer:	Roger
Remark:	power set: 0		
Test Standard:			

Start of Test: 2022-09-03 09:53:09

Test Graph

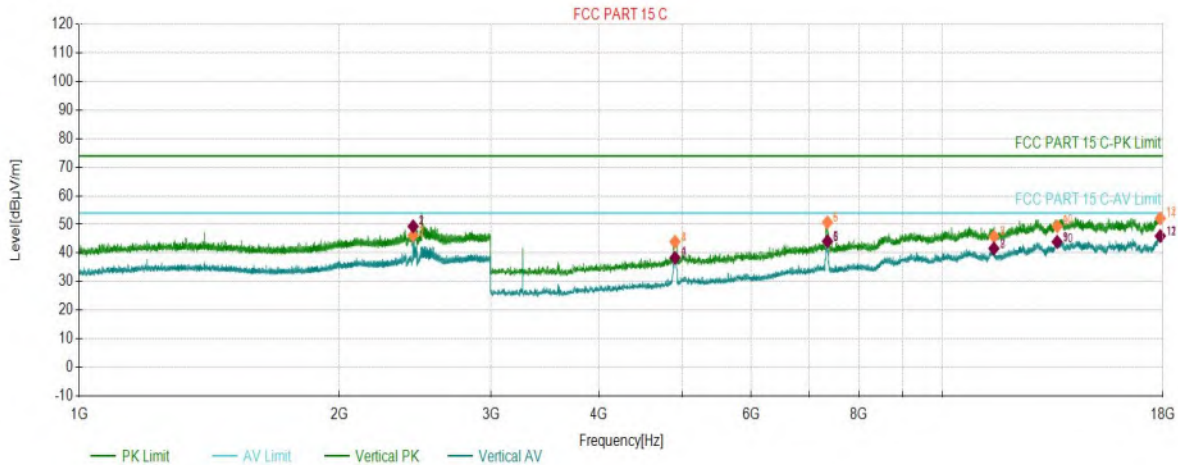

PK Final Data List

NO.	Freq. [MHz]	Factor [dB]	PK Value [dBµV/m]	PK Limit [dBµV/m]	PK Margin [dB]	Height [cm]	Angle [°]	Polarity
1	2436.3436	7.37	46.19	74.00	27.81	150	161	Vertical
3	4899.1899	-9.34	43.97	74.00	30.03	150	172	Vertical
5	7356.4356	-1.63	50.73	74.00	23.27	150	233	Vertical
7	11465.3465	5.61	45.77	74.00	28.23	150	68	Vertical
9	13571.5572	10.47	49.36	74.00	24.64	150	320	Vertical
11	17867.9868	14.62	52.14	74.00	21.86	150	129	Vertical

AV Final Data List

NO.	Freq. [MHz]	Factor [dB]	AV Value [dBµV/m]	AV Limit [dBµV/m]	AV Margin [dB]	Height [cm]	Angle [°]	Polarity
1	2436.3436	7.37	49.33	54.00	4.67	150	161	Vertical
3	4899.1899	-9.34	38.37	54.00	15.63	150	172	Vertical
5	7356.4356	-1.63	44.10	54.00	9.90	150	233	Vertical
7	11465.3465	5.61	41.60	54.00	12.40	150	68	Vertical
9	13571.5572	10.47	43.92	54.00	10.08	150	320	Vertical
11	17867.9868	14.62	45.96	54.00	8.04	150	129	Vertical

Restriction Band Emission

Test Report

Project Information			
Customer:		EUT:	PLUTO
Model:	SQPLUTO	SN:	
Mode:	11B_2412	Voltage:	AC120V/60Hz
Environment:	25°C/58%	Engineer:	Roger
Remark:	power set: 6		
Test Standard:			

Start of Test: 2022-09-03 11:25:14

Test Graph

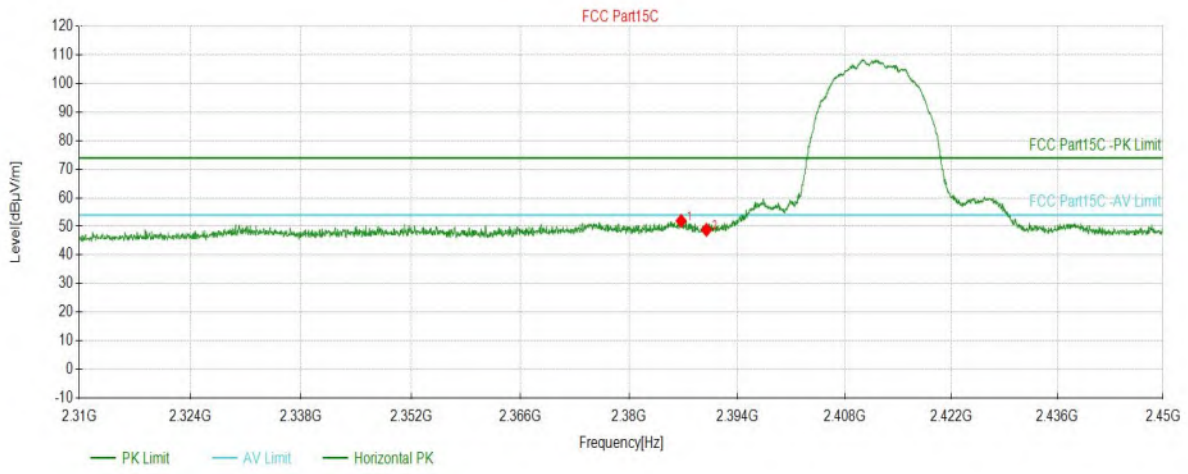

Suspected Data List									
NO.	Freq. [MHz]	Level [dBµV/m]	Factor [dB]	Limit [dBµV/m]	Margin [dB]	Height [cm]	Angle [°]	Detector	Polarity
1	2386.7456	51.95	6.46	74.00	22.05	150	218	PK	Horizont
2	2390.0133	48.81	6.47	74.00	25.19	150	214	PK	Horizont

Test Report

Project Information			
Customer:		EUT:	PLUTO
Model:	SQPLUTO	SN:	
Mode:	11B_2412	Voltage:	AC120V/60Hz
Environment:	25°C/58%	Engineer:	Roger
Remark:	power set: 6		
Test Standard:			

Start of Test: 2022-09-03 11:26:02

Test Graph

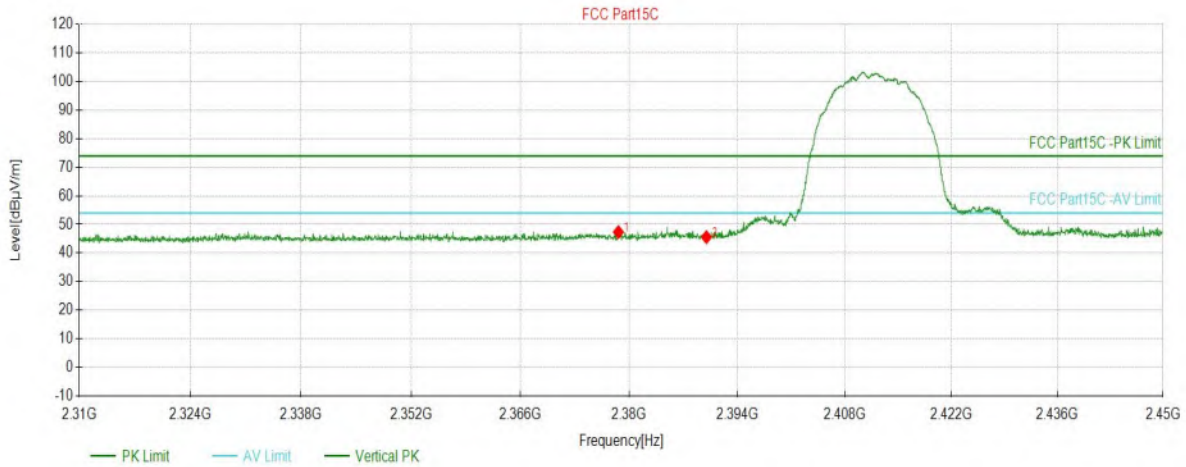

Suspected Data List									
NO.	Freq. [MHz]	Level [dBµV/m]	Factor [dB]	Limit [dBµV/m]	Margin [dB]	Height [cm]	Angle [°]	Detector	Polarity
1	2378.6229	47.33	6.44	74.00	26.67	150	110	PK	Vertical
2	2390.0133	45.57	6.47	74.00	28.43	150	162	PK	Vertical

Test Report

Project Information			
Customer:		EUT:	PLUTO
Model:	SQPLUTO	SN:	
Mode:	11B_2462	Voltage:	AC120V/60Hz
Environment:	25°C/58%	Engineer:	Roger
Remark:	power set: 5		
Test Standard:			

Start of Test: 2022-09-03 11:27:58

Test Graph

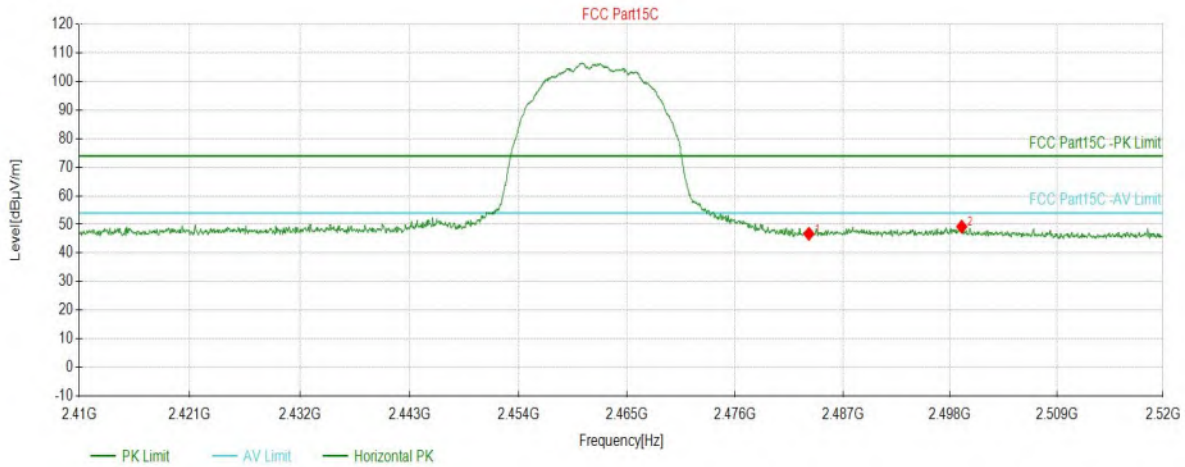

Suspected Data List									
NO.	Freq. [MHz]	Level [dBµV/m]	Factor [dB]	Limit [dBµV/m]	Margin [dB]	Height [cm]	Angle [°]	Detector	Polarity
1	2483.5168	46.74	7.09	74.00	27.26	150	226	PK	Horizont
2	2499.1996	49.23	7.20	74.00	24.77	150	84	PK	Horizont

Test Report

Project Information			
Customer:		EUT:	PLUTO
Model:	SQPLUTO	SN:	
Mode:	11B_2462	Voltage:	AC120V/60Hz
Environment:	25°C/58%	Engineer:	Roger
Remark:	power set: 5		
Test Standard:			

Start of Test: 2022-09-03 11:28:51

Test Graph

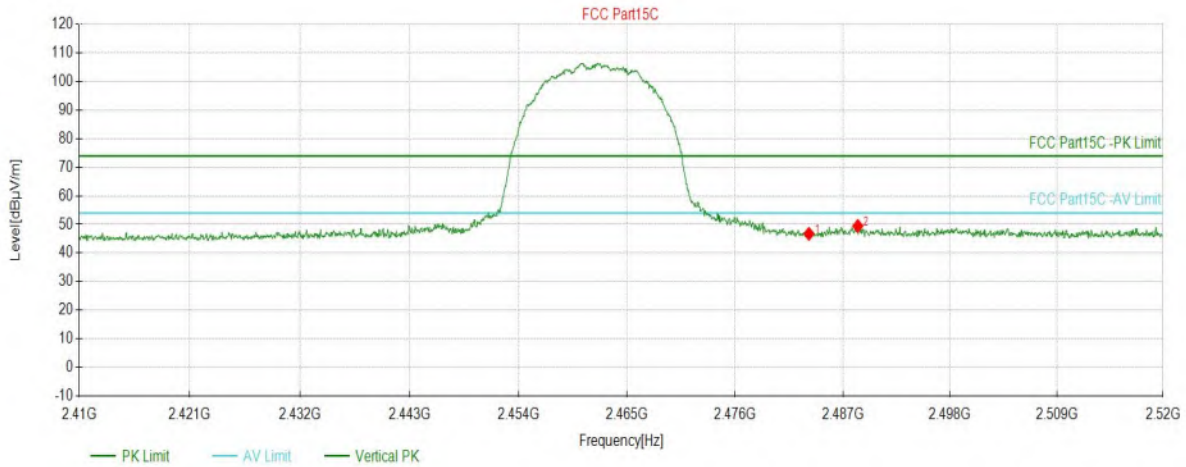

Suspected Data List									
NO.	Freq. [MHz]	Level [dBµV/m]	Factor [dB]	Limit [dBµV/m]	Margin [dB]	Height [cm]	Angle [°]	Detector	Polarity
1	2483.516	46.74	7.09	74.00	27.26	150	199	PK	Vertical
2	2488.524	49.46	7.13	74.00	24.54	150	162	PK	Vertical

Test Report

Project Information			
Customer:		EUT:	PLUTO
Model:	SQPLUTO	SN:	
Mode:	11G_2412	Voltage:	AC120V/60Hz
Environment:	25°C/58%	Engineer:	Roger
Remark:	power set: 0		
Test Standard:			

Start of Test: 2022-09-03 11:31:20

Test Graph

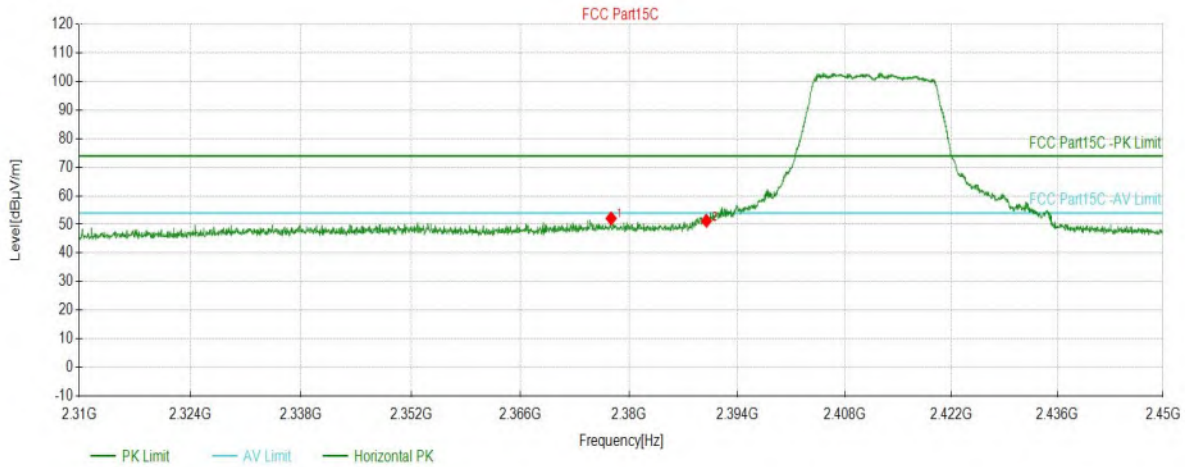

Suspected Data List									
NO.	Freq. [MHz]	Level [dBµV/m]	Factor [dB]	Limit [dBµV/m]	Margin [dB]	Height [cm]	Angle [°]	Detector	Polarity
1	2377.6892	52.12	6.44	74.00	21.88	150	220	PK	Horizont
2	2390.0133	51.26	6.47	74.00	22.74	150	220	PK	Horizont

Test Report

Project Information			
Customer:		EUT:	PLUTO
Model:	SQPLUTO	SN:	
Mode:	11G_2412	Voltage:	AC120V/60Hz
Environment:	25°C/58%	Engineer:	Roger
Remark:	power set: 0		
Test Standard:			

Start of Test: 2022-09-03 11:32:01

Test Graph

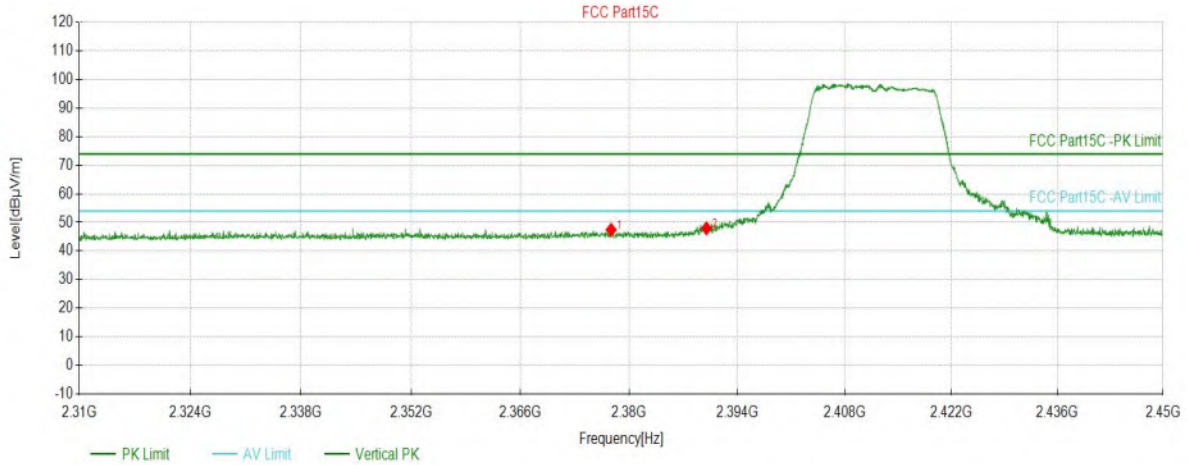

Suspected Data List									
NO.	Freq. [MHz]	Level [dBµV/m]	Factor [dB]	Limit [dBµV/m]	Margin [dB]	Height [cm]	Angle [°]	Detector	Polarity
1	2377.6892	47.43	6.44	74.00	26.57	150	67	PK	Vertical
2	2390.0133	47.95	6.47	74.00	26.05	150	154	PK	Vertical

Test Report

Project Information			
Customer:		EUT:	PLUTO
Model:	SQPLUTO	SN:	
Mode:	11G_2462	Voltage:	AC120V/60Hz
Environment:	25°C/58%	Engineer:	Roger
Remark:	power set: 0		
Test Standard:			

Start of Test: 2022-09-03 11:35:19

Test Graph

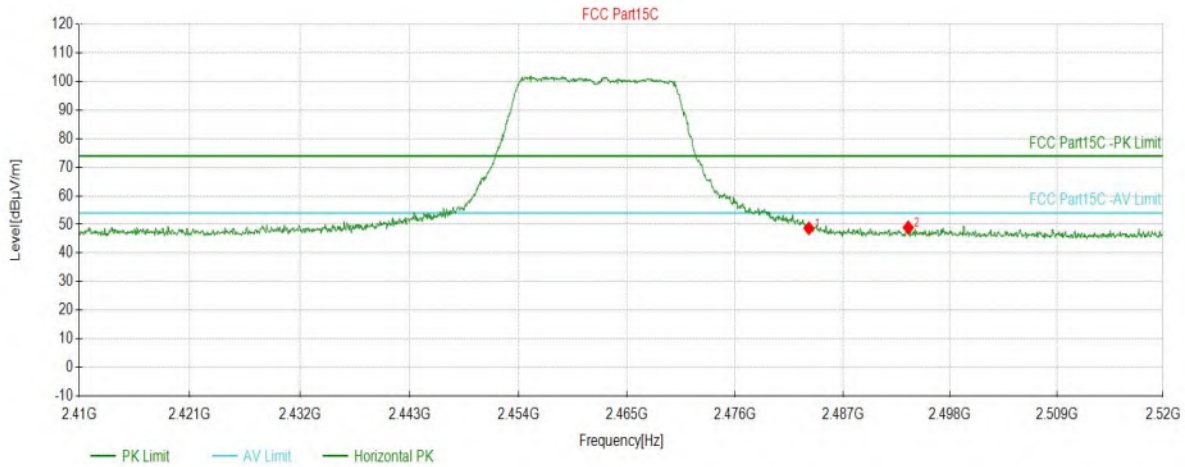

Suspected Data List									
NO.	Freq. [MHz]	Level [dBµV/m]	Factor [dB]	Limit [dBµV/m]	Margin [dB]	Height [cm]	Angle [°]	Detector	Polarity
1	2483.5168	48.65	7.09	74.00	25.35	150	77	PK	Horizont
2	2493.6968	48.92	7.16	74.00	25.08	150	84	PK	Horizont

Test Report

Project Information			
Customer:		EUT:	PLUTO
Model:	SQPLUTO	SN:	
Mode:	11G_2462	Voltage:	AC120V/60Hz
Environment:	25°C/58%	Engineer:	Roger
Remark:	power set: 0		
Test Standard:			

Start of Test: 2022-09-03 11:36:03

Test Graph

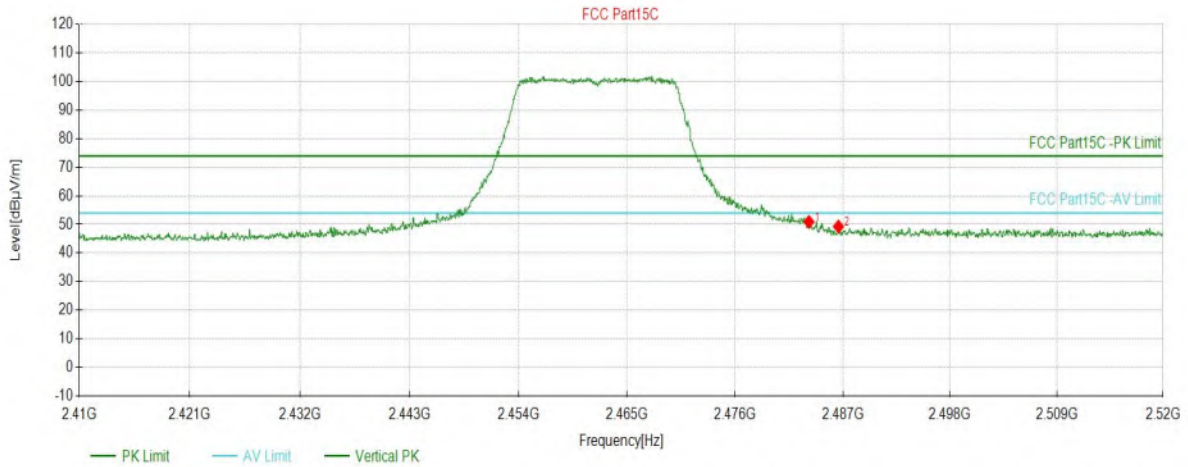

Suspected Data List									
NO.	Freq. [MHz]	Level [dBµV/m]	Factor [dB]	Limit [dBµV/m]	Margin [dB]	Height [cm]	Angle [°]	Detector	Polarity
1	2483.5168	50.89	7.09	74.00	23.11	150	197	PK	Vertical
2	2486.5433	49.25	7.11	74.00	24.75	150	195	PK	Vertical

Test Report

Project Information			
Customer:		EUT:	PLUTO
Model:	SQPLUTO	SN:	
Mode:	11N20_2412	Voltage:	AC120V/60Hz
Environment:	25°C/58%	Engineer:	Roger
Remark:	power set: 0		
Test Standard:			

Start of Test: 2022-09-03 11:38:13

Test Graph

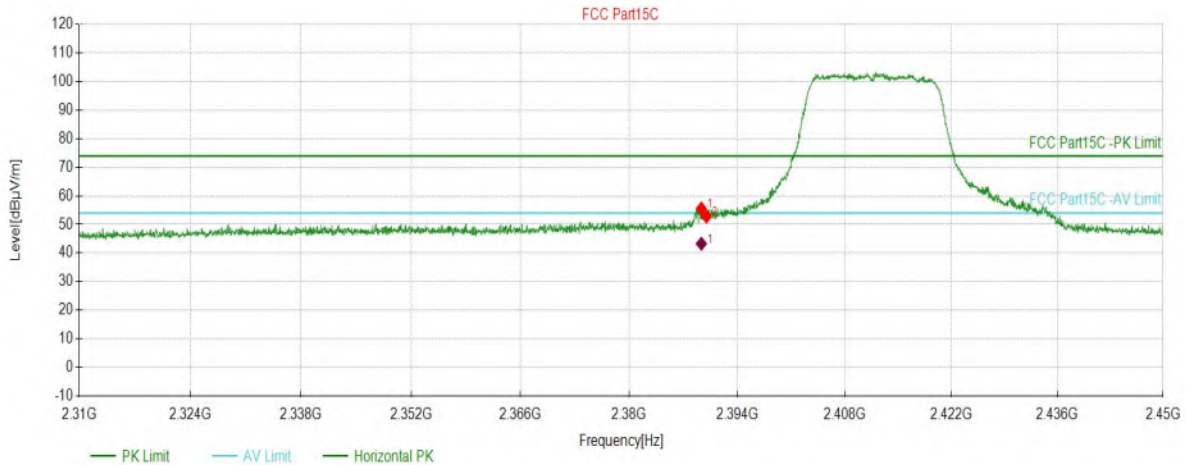

Suspected Data List									
NO.	Freq. [MHz]	Level [dBµV/m]	Factor [dB]	Limit [dBµV/m]	Margin [dB]	Height [cm]	Angle [°]	Detect or	Polarity
1	2389.3598	55.58	6.47	74.00	18.42	150	221	PK	Horizontal
2	2390.0133	52.73	6.47	74.00	21.27	150	193	PK	Horizontal

AV Final Data List								
NO.	Freq. [MHz]	Factor [dB]	AV Value [dBµV/m]	AV Limit [dBµV/m]	AV Margin [dB]	Height [cm]	Angle [°]	Polarity
1	2389.3596	6.47	43.29	54.00	10.71	150	217.8	Horizontal

Test Report

Project Information			
Customer:		EUT:	PLUTO
Model:	SQPLUTO	SN:	
Mode:	11N20_2412	Voltage:	AC120V/60Hz
Environment:	25°C/58%	Engineer:	Roger
Remark:	power set: 0		
Test Standard:			

Start of Test: 2022-09-03 11:39:01

Test Graph

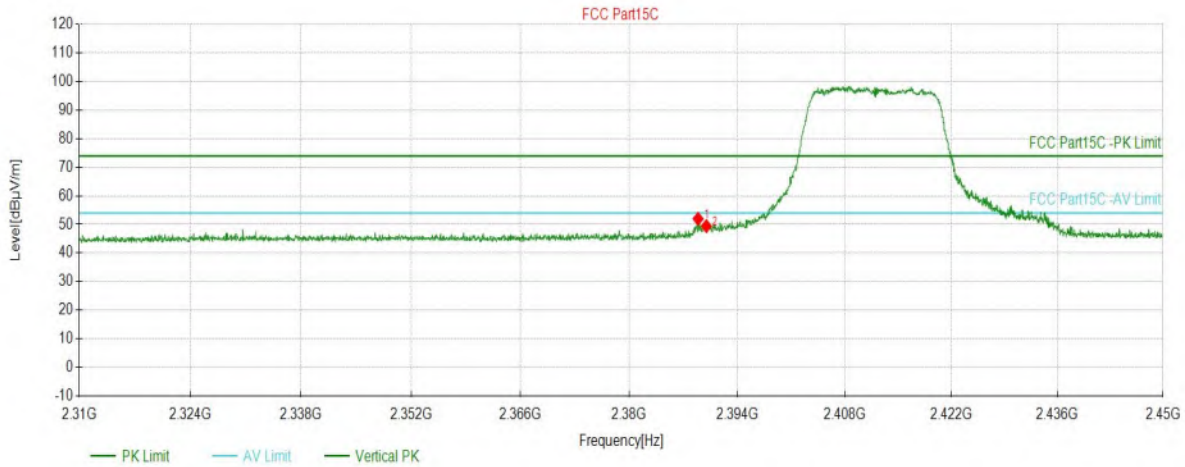

Suspected Data List									
NO.	Freq. [MHz]	Level [dBµV/m]	Factor [dB]	Limit [dBµV/m]	Margin [dB]	Height [cm]	Angle [°]	Detector	Polarity
1	2388.9396	51.97	6.47	74.00	22.03	150	156	PK	Vertical
2	2390.0133	49.41	6.47	74.00	24.59	150	355	PK	Vertical

Test Report

Project Information			
Customer:		EUT:	PLUTO
Model:	SQPLUTO	SN:	
Mode:	11N20_2462	Voltage:	AC120V/60Hz
Environment:	25°C/58%	Engineer:	Roger
Remark:	power set: 0		
Test Standard:			

Start of Test: 2022-09-03 11:44:35

Test Graph

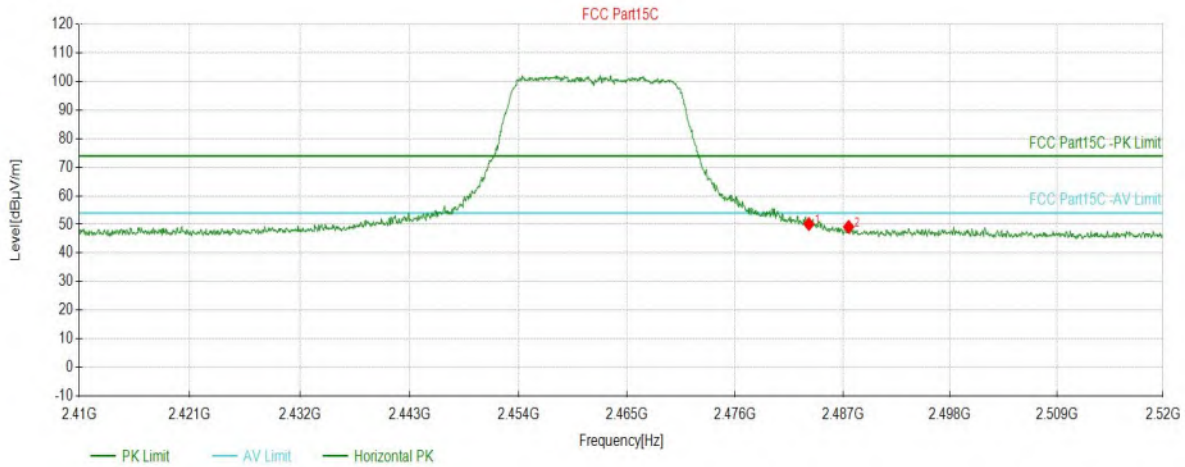

Suspected Data List									
NO.	Freq. [MHz]	Level [dBµV/m]	Factor [dB]	Limit [dBµV/m]	Margin [dB]	Height [cm]	Angle [°]	Detector	Polarity
1	2483.5168	50.14	7.09	74.00	23.86	150	232	PK	Horizont
2	2487.5888	49.19	7.12	74.00	24.81	150	75	PK	Horizont

Test Report

Project Information			
Customer:		EUT:	PLUTO
Model:	SQPLUTO	SN:	
Mode:	11N20_2462	Voltage:	AC120V/60Hz
Environment:	25°C/58%	Engineer:	Roger
Remark:	power set: 0		
Test Standard:			

Start of Test: 2022-09-03 11:45:28

Test Graph

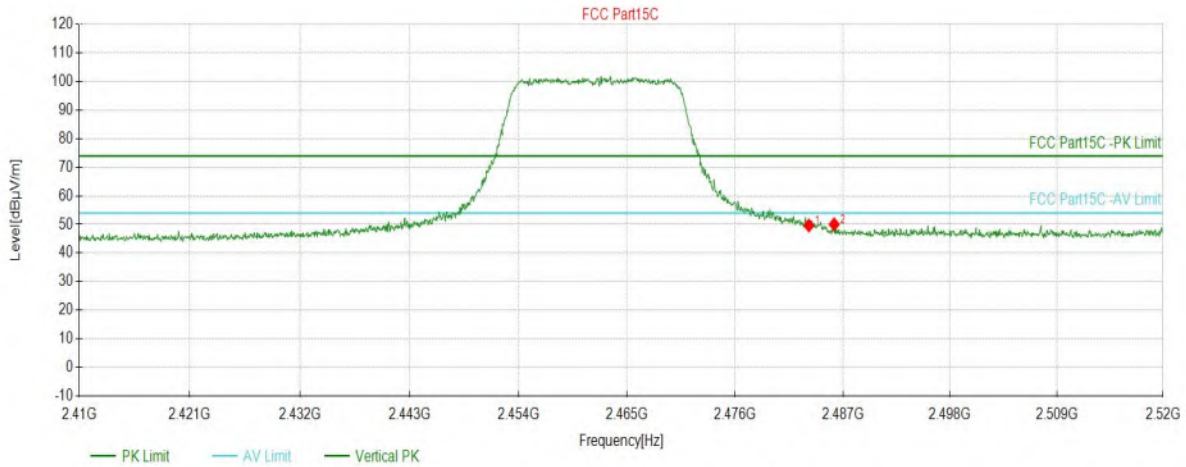

Suspected Data List									
NO.	Freq. [MHz]	Level [dBµV/m]	Factor [dB]	Limit [dBµV/m]	Margin [dB]	Height [cm]	Angle [°]	Detector	Polarity
1	2483.5168	49.64	7.09	74.00	24.36	150	205	PK	Vertical
2	2486.1031	50.05	7.11	74.00	23.95	150	198	PK	Vertical

Test Report

Project Information			
Customer:		EUT:	PLUTO
Model:	SQPLUTO	SN:	
Mode:	11N40_2422	Voltage:	AC120V/60Hz
Environment:	25°C/58%	Engineer:	Roger
Remark:	power set: 0		
Test Standard:			

Start of Test: 2022-09-03 11:49:27

Test Graph

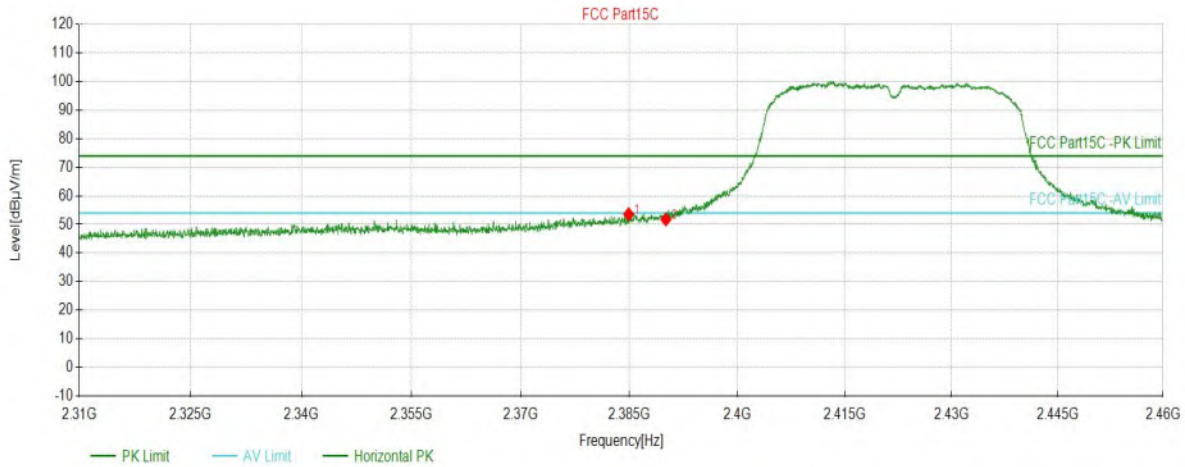

Suspected Data List									
NO.	Freq. [MHz]	Level [dBµV/m]	Factor [dB]	Limit [dBµV/m]	Margin [dB]	Height [cm]	Angle [°]	Detector	Polarity
1	2384.8750	53.57	6.46	74.00	20.43	150	225	PK	Horizont
2	2390.0267	51.73	6.47	74.00	22.27	150	220	PK	Horizont

Test Report

Project Information			
Customer:		EUT:	PLUTO
Model:	SQPLUTO	SN:	
Mode:	11N40_2422	Voltage:	AC120V/60Hz
Environment:	25°C/58%	Engineer:	Roger
Remark:	power set: 0		
Test Standard:			

Start of Test: 2022-09-03 11:50:07

Test Graph

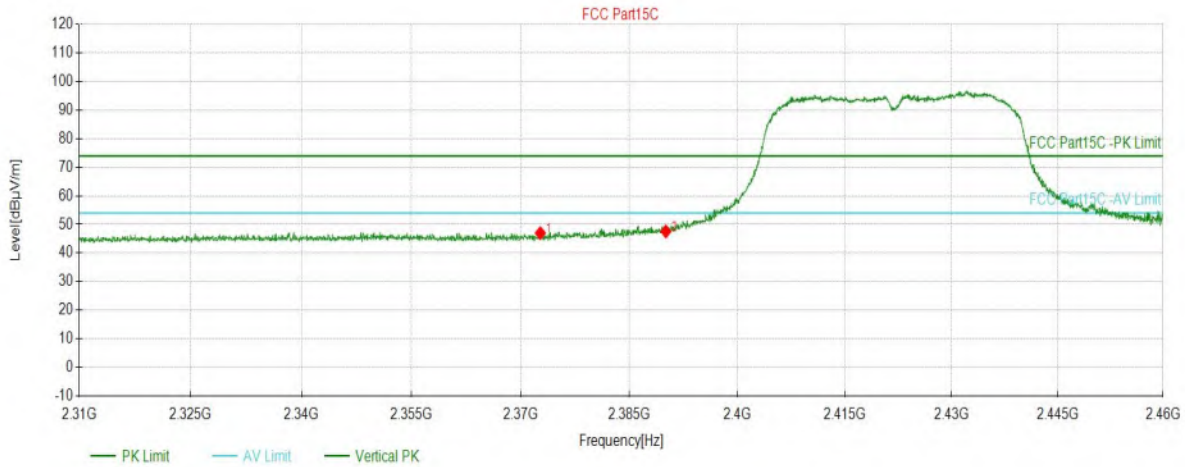

Suspected Data List									
NO.	Freq. [MHz]	Level [dBµV/m]	Factor [dB]	Limit [dBµV/m]	Margin [dB]	Height [cm]	Angle [°]	Detector	Polarity
1	2372.6709	46.97	6.43	74.00	27.03	150	9	PK	Vertical
2	2390.0267	47.54	6.47	74.00	26.46	150	115	PK	Vertical

Test Report

Project Information			
Customer:		EUT:	PLUTO
Model:	SQPLUTO	SN:	
Mode:	11N40_2452	Voltage:	AC120V/60Hz
Environment:	25°C/58%	Engineer:	Roger
Remark:	power set: 0		
Test Standard:			

Start of Test: 2022-09-03 11:52:23

Test Graph

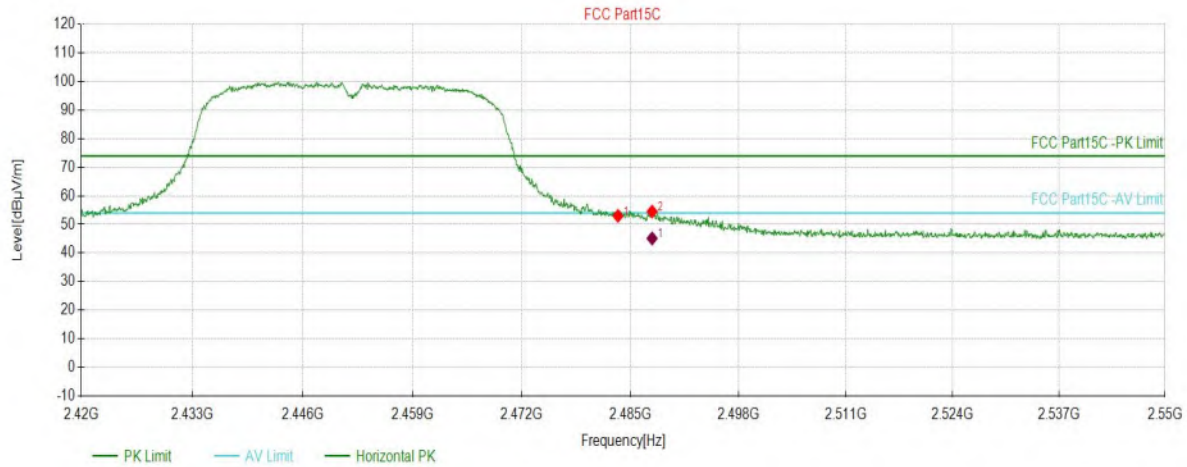

Suspected Data List

NO.	Freq. [MHz]	Level [dBµV/m]	Factor [dB]	Limit [dBµV/m]	Margin [dB]	Height [cm]	Angle [°]	Detector	Polarity
1	2483.5368	52.98	7.09	74.00	21.02	150	83	PK	Horizont
2	2487.6338	54.51	7.12	74.00	19.49	150	225	PK	Horizont

AV Final Data List

NO.	Freq. [MHz]	Factor [dB]	AV Value [dBµV/m]	AV Limit [dBµV/m]	AV Margin [dB]	Height [cm]	Angle [°]	Polarity
1	2487.6338	7.12	45.12	54.00	8.88	150	225	Horizontal

Test Report

Project Information			
Customer:		EUT:	PLUTO
Model:	SQPLUTO	SN:	
Mode:	11N40_2452	Voltage:	AC120V/60Hz
Environment:	25°C/58%	Engineer:	Roger
Remark:	power set: 0		
Test Standard:			

Start of Test: 2022-09-03 11:53:15

Test Graph

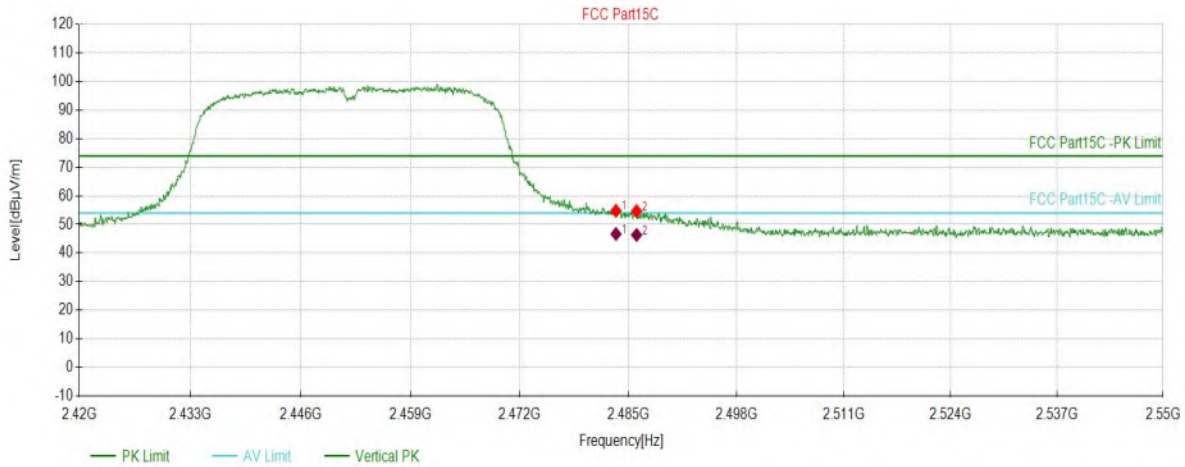

Suspected Data List									
NO.	Freq. [MHz]	Level [dBµV/m]	Factor [dB]	Limit [dBµV/m]	Margin [dB]	Height [cm]	Angle [°]	Detector	Polarity
1	2483.5368	54.78	7.09	74.00	19.22	150	199	PK	Vertical
2	2486.0080	54.65	7.11	74.00	19.35	150	195	PK	Vertical

AV Final Data List								
NO.	Freq. [MHz]	Factor [dB]	AV Value [dBµV/m]	AV Limit [dBµV/m]	AV Margin [dB]	Height [cm]	Angle [°]	Polarity
1	2483.5369	7.09	46.68	54.00	7.32	156.9	201.2	Vertical
2	2486.0080	7.11	46.33	54.00	7.67	157	197.7	Vertical

APPENDIX C – AC Power Line Conducted Emission Test Data

Conducted Emission Measurement

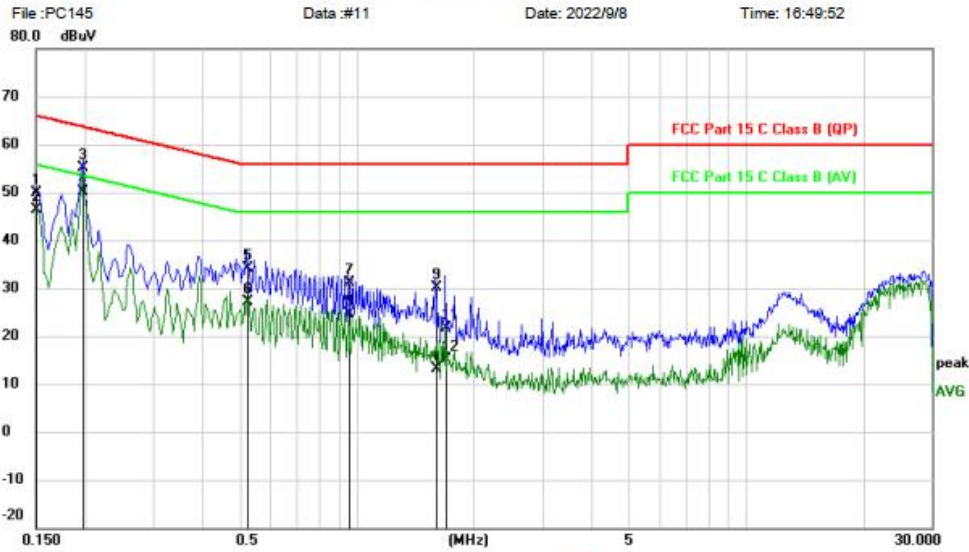

File :PC145
 80.0 dBuV
 Data :#11
 Date: 2022/9/8
 Time: 16:49:52

Site: _____ Phase: **L1** Temperature: 26
 Limit: FCC Part 15 C Class B (QP) Power: AC 120V/60Hz Humidity: 60 %
 EUT: Powerstation
 M/N: PC145
 Mode: WIFI
 Note:

No. Mk.	Freq.	Reading Level	Correct Factor	Measurement	Limit	Over	Detector	Comment
	MHz	dBuV	dB	dBuV	dBuV	dB		
1	0.1500	40.23	9.59	49.82	66.00	-16.18	QP	
2	0.1500	36.87	9.59	46.46	56.00	-9.54	AVG	
3	0.1980	45.54	9.59	55.13	63.69	-8.56	QP	
4 *	0.1980	40.55	9.59	50.14	53.69	-3.55	AVG	
5	0.5220	24.65	9.60	34.25	56.00	-21.75	QP	
6	0.5220	17.56	9.60	27.16	46.00	-18.84	AVG	
7	0.9540	21.43	9.61	31.04	56.00	-24.96	QP	
8	0.9540	15.07	9.61	24.68	46.00	-21.32	AVG	
9	1.5980	20.45	9.61	30.06	56.00	-25.94	QP	
10	1.5980	3.44	9.61	13.05	46.00	-32.95	AVG	
11	1.6900	12.00	9.61	21.61	56.00	-34.39	QP	
12	1.6900	5.45	9.61	15.06	46.00	-30.94	AVG	

Conducted Emission Measurement

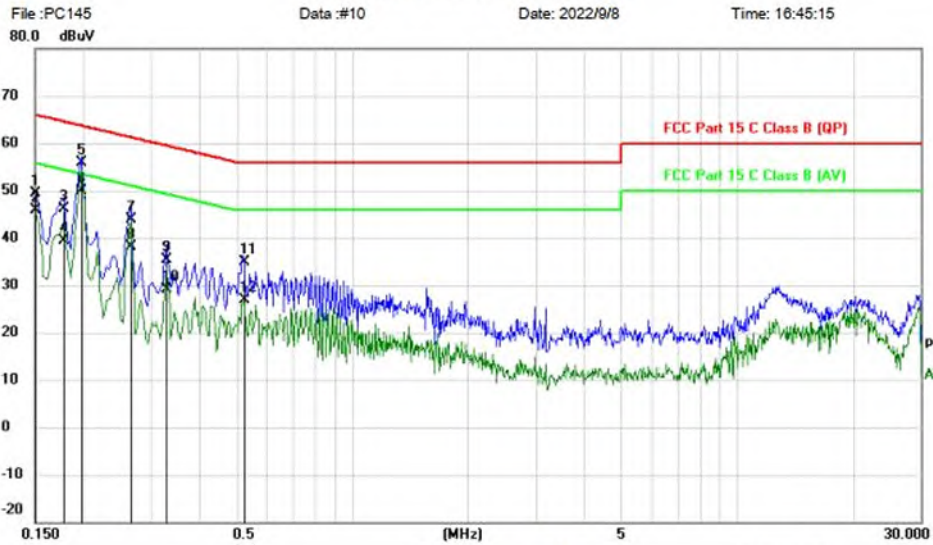

Site: _____ Phase: **N** Temperature: 26
 Limit: FCC Part 15 C Class B (QP) Power: AC 120V/60Hz Humidity: 60 %
 EUT: Powerstation
 M/N: PC145
 Mode: WIFI
 Note:

No. Mk.	Freq. MHz	Reading Level dBuV	Correct Factor dB	Measure- ment dBuV	Limit dBuV	Over dB	Detector	Comment
1	0.1500	39.89	9.59	49.48	66.00	-16.52	QP	
2	0.1500	36.36	9.59	45.95	56.00	-10.05	AVG	
3	0.1780	36.55	9.59	46.14	64.58	-18.44	QP	
4	0.1780	29.70	9.59	39.29	54.58	-15.29	AVG	
5	0.1980	46.37	9.59	55.96	63.69	-7.73	QP	
6 *	0.1980	40.35	9.59	49.94	53.69	-3.75	AVG	
7	0.2660	34.32	9.59	43.91	61.24	-17.33	QP	
8	0.2660	28.55	9.59	38.14	51.24	-13.10	AVG	
9	0.3300	25.85	9.60	35.45	59.45	-24.00	QP	
10	0.3300	19.55	9.60	29.15	49.45	-20.30	AVG	
11	0.5220	25.29	9.60	34.89	56.00	-21.11	QP	
12	0.5220	17.22	9.60	26.82	46.00	-19.18	AVG	

END OF REPORT