

# PYLE

PyleUSA.com



## *PowerSports*

### ***PLMRBT18***

**Amplified Wireless BT Audio Controller**

Waterproof-Rated Marine Receiver  
Remote Control for Car, Truck, Boat, 4x4,  
PowerSport Vehicles (300 Watt)

USER MANUAL

## Wire Diagram

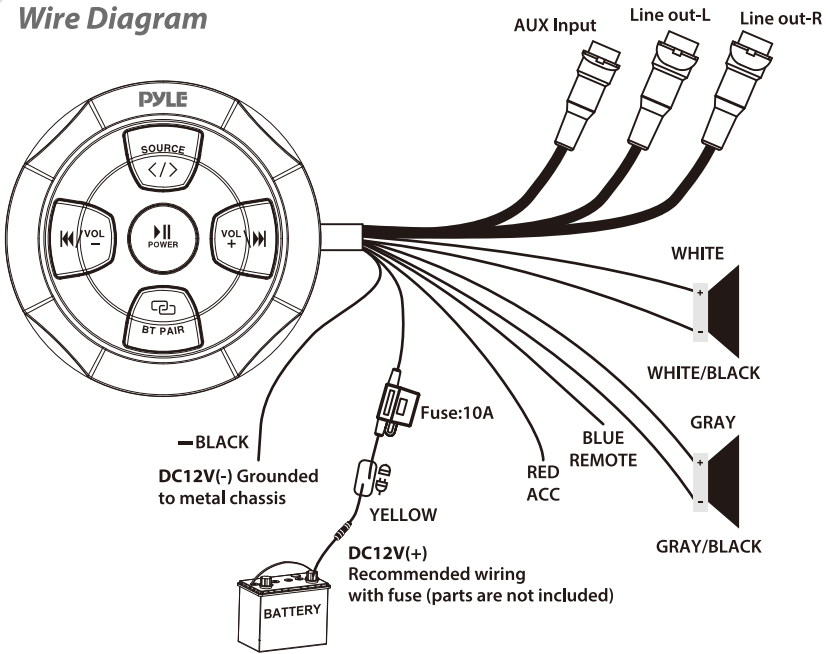

Wire Color	Description
Yellow	Battery (+), 12dc
Black	Battery (-), Ground
Red	ACC
Blue	REMOTE
White	Output L (+)
White/Black	Output L (-)
Gray	Output R (+)
Gray/Black	Output R (-)

## BT Pairing and Connection

### Power:

1. Press and hold the power button to power **ON/OFF**.

### Wireless BT Streaming Connection:

- a. Ensure BT ability is activated, then search for the PLMRBT18 from your BT-enabled device. The light will turn blue and blinks while waiting for BT connection.
- b. The PLMRBT18 BT Network Name will appear as "**PyleUSA**" (No password is required for connecting).
- c. When the BT is connected, the light will turn blue and stops blinking.









## AUX-IN:

a. Short press  to switch BT mode/Aux-in mode.

## Auto Reconnection:

- When the device is out of the BT range, BT will be disconnected automatically, the light turns blue while blinking.
- BT will automatically reconnect when detected in range again in 10 minutes.
- Disconnected BT after 10 minutes, you need to process BT connection steps (above) to reconnect BT again.
- If the other device occupied the BT during this period (10mins), you need to process BT connection steps (above).
- If there is no connection during this period (10mins), it will turn to standby mode.

## Playing Music

- Press and hold  for 3 seconds to Power ON or OFF.
- Short press  to play music or pause.
- Short press  to switch BT mode/Aux-in mode.
- Short press  for next track, press and hold  for volume up.
- Short press  for previous track, press and hold  for volume down.
- Press and hold  to disconnect BT.

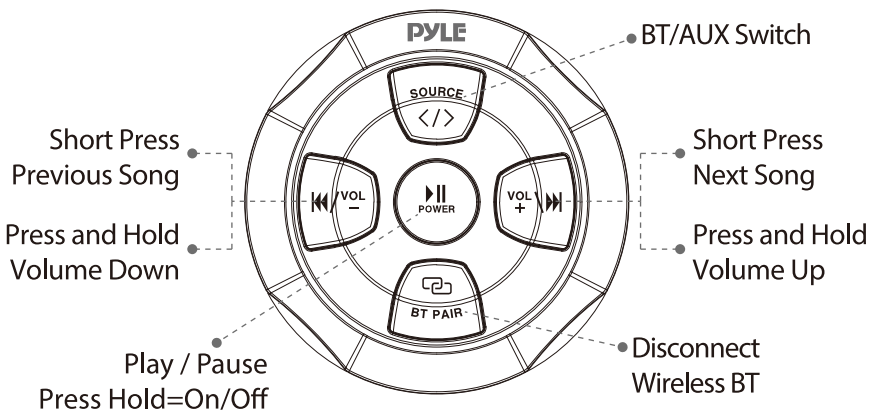

## Installation (Seamless Flush Mount)

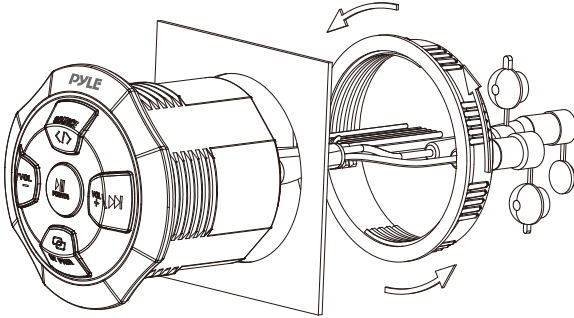

### Size:

96mm / 3.8" (Out Diameter)

76mm / 3.0" (Cutout Diameter)

93mm / 3.7" (Depth)

### **PLMRBT18**

#### **Amplified Wireless BT Audio Controller**

Waterproof-Rated Marine Receiver Remote Control for Car, Truck, Boat, 4x4, PowerSport Vehicles (300 Watt)

### Features:

- Universal Mount Wireless BT Streaming Control Unit
- Built-in Wireless BT Audio Receiver
- Waterproof-Rated Marine Grade Construction
- Water-Resistant & Weatherproof Design
- 2-Channel Amplifier Style
- Connect & Stream Audio from Additional External Devices
- Aux (3.5mm) Input
- Full Range Stereo Sound Reproduction
- Integrated Power Wiring Harness
- Pre-Amp RCA Out to Any OEM/Factory Made Mono-Block/ Full-Range Amplifier
- Flush Mount Mounting Kit Included
- Universal Vehicle Mounting
- Can be In-Console Flush Mount
- Anti-Thump Turn-On
- Soft Turn On/Off
- Overload & Power Protection Circuitry
- Used for Car, Truck, ATV, UTV, 4x4, Boat, Marine Watercraft, PowerSport Vehicles

### **Wireless BT Music Streaming:**

- Simple & Hassle-Free Pairing
- Instant Wireless Audio Streaming Receiver
- Works with All of Today's Latest Devices  
Smartphones, Tablets, Laptops, Computers, etc.
- Wireless BT Version: 5.0
- Wireless BT Network Name: 'PyleUSA'
- Wireless Range: 30'+ ft.

### **What's in the Box:**

- Wireless BT Control Unit
- Audio Connection Cable, 3.5mm
- Owner's Manual
- Warranty Card

### **Technical Specs:**

- Power Output: 300 Watt MAX
- 2 x 75 Watts RMS @ 4 Ohm
- 2 x 150 Watts MAX @ 4 Ohm
- Marine Grade Waterproof Rating: IP-65
- Amplifier Type: Class-D
- T.H.D: 0.1%
- S/N Ratio: >95dB
- Channel Separation: >65dB
- Frequency Response: 10Hz-40kHz
- Fuse: 10A
- Power Supply: DC 12V
- Cut-Out Diameter: 3" –inches
- Mounting Depth: 3.7" –inches
- Total Unit Dimensions (L x W x H):  
3.8" x 3.8" x 4.17" –inches (Flush Mount)

#### ***Questions? Issues?***

We are here to help!

Phone: (1) 718-535-1800

Email: [support@pyleusa.com](mailto:support@pyleusa.com)

# PYLE

PyleUSA.com



VISIT US ONLINE:

*Have a question?*

*Need service or repair?*

*Want to leave a comment?*

[PyleUSA.com/ContactUs](https://www.pyleusa.com/ContactUs)

## PYLE



**WARNING:**

This products can expose you to a chemical or group of chemicals, which may include "**Di (2-ethylhexyl) phthalate (DEHP)**" which is known in the state of California to cause cancer, birth defects, or other reproductive harm. For more info, go to <https://www.p65warnings.ca.gov/>.

## FCC Warning

This device complies with part 15 of the FCC Rules. Operation is subject to the following two conditions: (1) This device may not cause harmful interference, and (2) this device must accept any interference received, including interference that may cause undesired operation.

Any Changes or modifications not expressly approved by the party responsible for compliance could void the user's authority to operate the equipment.

**Note:** This equipment has been tested and found to comply with the limits for a Class B digital device, pursuant to part 15 of the FCC Rules. These limits are designed to provide reasonable protection against harmful interference in a residential installation. This equipment generates uses and can radiate radio frequency energy and, if not installed and used in accordance with the instructions, may cause harmful interference to radio communications. However, there is no guarantee that interference will not occur in a particular installation. If this equipment does cause harmful interference to radio or television reception, which can be determined by turning the equipment off and on, the user is encouraged to try to correct the interference by one or more of the following measures:

- Reorient or relocate the receiving antenna.
- Increase the separation between the equipment and receiver.
- Connect the equipment into an outlet on a circuit different from that to which the receiver is connected.
- Consult the dealer or an experienced radio/TV technician for help.

This equipment complies with FCC radiation exposure limits set forth for an uncontrolled environment. This equipment should be installed and operated with minimum distance 20cm between the radiator & your body.