



TEST REPORT

FCC ID: 2A5UI-BM5WR

Product: LCD monitors

Model No.: BM5 III WR

Additional Model No.: PT6L,LH5U,LH5W, BM5WR ,BM5 IV WR ,BM5 V WR , LH5H II ,LH5H III ,LH5H V , LH5P II ,LH5P III ,BM7 II WR ,BM7 III WR ,RH8,OEYEW,OEYEW II ,KEYGRIP II ,BKEY,BKEY II ,BKEY III ,Shooter,Shooter II , Shooter III ,LH7P,LH7P II ,LH7H,LH7H II ,LH8P,LH8P II ,LH8H,LH8H II

Trade Mark: **PortKeys**

Report No.: WSCT-A2LA-R&E220300105A-BLE

Issued Date: 01 April 2022

Issued for:

SHENZHEN PORTKEYS ELECTRONIC TECHNOLOGY CO.,LTD
ROOM 201, BUILDING 1 , NO. 101, SHANGWEI ROAD, SHANGWEI VILLAGE,
ZHANGKENGJING COMMUNITY, GUANHU STREET, LONGHUA DISTRICT,
SHENZHEN FOTAN NT

Issued By:

WORLD STANDARDIZATION CERTIFICATION & TESTING GROUP
(SHENZHEN) CO., LTD.
Building A-B, Baoshi Road, Baoshi Science & Technology Park, Bao'an District,
Shenzhen, Guangdong, People's Republic of China
TEL: + (86) 13924678855
FAX: +86-755-86376605



Note: In recognition of the successful completion of the A2LA evaluation process, (including an assessment of the laboratory's compliance with A2LA's ENERGY STAR ® Accreditation Program requirements 1) accreditation is granted to this laboratory to perform the following tests: EMC, electromagnetic compatibility, telecommunications and Energy Star.





TABLE OF CONTENTS

1. GENERAL INFORMATION	3
2. GENERAL DESCRIPTION OF EUT	4
3. Facilities and Accreditations.....	5
3.1. ACCREDITATIONS	5
3.2. TEST DESCRIPTION.....	6
3.3. DESCRIPTION OF SUPPORT UNITS (CONDUCTED MODE).....	9
3.4. SUMMARY OF TEST RESULTS	10
4. MEASUREMENT INSTRUMENTS.....	11
5. ANTENNA REQUIREMENT.....	12
5.1. STANDARD APPLICABLE	12
5.2. ANTENNA CONNECTOR CONSTRUCTION	12
6. CONDUCTED EMISSIONS	13
7. SPURIOUS EMISSIONS.....	15
8. -6dB BANDWIDTH TESTING.....	23
9. MAXIMUM PEAK OUTPUT POWER	26
10. 100 kHz Bandwidth of Frequency Band Edge	29
11. MAXIMUM CONDUCTED POWER SPECTRAL DENSITY.....	33





1. GENERAL INFORMATION

Product: LCD monitors
Model No.: BM5 III WR
Additional Model: PT6L,LH5U,LH5W , BM5WR ,BM5 IV WR ,BM5 V WR , LH5H II ,LH5H III,LH5H V , LH5P II ,LH5P III,BM7 II WR ,BM7 III WR ,RH8,OEYEWR,OEYEWR II ,KEYGRIP II ,BKEY,BKEY II ,BKEY III ,Shooter,Shooter II , Shooter III ,LH7P,LH7P II ,LH7H,LH7H II ,LH8P,LH8P II ,LH8H,LH8H II

Trade Mark: **PortKeys**
Applicant: SHENZHEN PORTKEYS ELECTRONIC TECHNOLOGY CO.,LTD
Address: ROOM 201, BUILDING 1 , NO. 101, SHANGWEI ROAD, SHANGWEI VILLAGE, ZHANGKENGJING COMMUNITY, GUANHU STREET, LONGHUA DISTRICT, SHENZHEN FOTAN NT

Manufacturer: SHENZHEN PORTKEYS ELECTRONIC TECHNOLOGY CO.,LTD
Address: Room 201, Building 1, No. 101, ShangWei Road, ShangWei Village, ZhangKengJing Community, GuanHu Street, LongHua District, ShenZhen

Data of receipt: 11March 2022
Date of Test: 11March 2022 to 30March 2022
Applicable Standards: FCC CFR Title 47 Part 15 Subpart C

Deviation from Applicable Standard
None

The above equipment has been tested by World Standardization Certification & Testing Group (Shenzhen) Co., Ltd. And found compliance with the requirements set forth in the technical standards mentioned above. The results of testing in this report apply only to the product/system, which was tested. Other similar equipment will not necessarily produce the same results due to production tolerance and measurement uncertainties.

Tested By: Wang Xiang
(Wang Xiang)

Check By: Chen Xu
(Chen Xu)

Approved By: Wang Fengbing
(Wang Fengbing)

Date: 01 April 2022





2. GENERAL DESCRIPTION OF EUT

Equipment Type:	LCD monitors
Test Model:	BM5 III WR
Additional Model:	PT6L,LH5U,LH5W , BM5WR ,BM5 IV WR ,BM5 V WR , LH5H II ,LH5H III,LH5H V , LH5P II ,LH5P III,BM7 II WR ,BM7 III WR , RH8,OEYEWR,OEYEWR II,KEYGRIP II ,BKEY,BKEY II ,BKEY III, Shooter,Shooter II , Shooter III ,LH7P,LH7P II ,LH7H,LH7H II ,LH8P, LH8P II ,LH8H,LH8H II
Trade Mark	PortKeys
Hardware version:	NA
Software version:	N/A
Power Supply	DC 12V
Operating Frequency:	2402-2480MHz
Channels:	40
Channel Spacing:	2MHz
Modulation Type:	GFSK, $\pi/4$ -DQPSK, 8-DPSK for BR+EDR
Antenna Type:	RP-SMA
Antenna gain:	0.78dBi

Models difference

BM5 III WR ,PT6L,LH5U,LH5W, BM5WR ,BM5 WR,BM5 IV WR ,BM5 V WR , LH5H II ,LH5H III,LH5H V , LH5P II ,LH5P III,BM7 II WR ,BM7 III WR ,RH8,OEYEWR,OEYEWR II,KEYGRIP II ,BKEY,BKEY II ,BKEY III, Shooter,Shooter II , Shooter III ,LH7P,LH7P II ,LH7H,LH7H II ,LH8P,LH8P II ,LH8H,LH8H II are series models, only the appearance size is different,the main test is BM5 III WR.





3. Facilities and Accreditations

All measurement facilities used to collect the measurement data are located at **Building A-B, Baoshi Science & Technology Park, Baoshi Road, Bao'an District, Shenzhen, Guangdong, China of the WORLD STANDARDIZATION CERTIFICATION & TESTING GROUP (SHENZHEN) CO., LTD.**

The sites are constructed in conformance with the requirements of ANSI C63.4 and CISPR Publication 22. All receiving equipment conforms to CISPR Publication 16-1, "Radio Interference Measuring Apparatus and Measurement Methods."

3.1. ACCREDITATIONS

China National Accreditation Service for Conformity Assessment (CNAS)

Registration number NO: L3732

American Association for Laboratory Accreditation(A2LA)

Registration NO: 5768.01

Copies of granted accreditation certificates are available for downloading from our web site, <http://www.wsct-cert.com>





Report No.: WSCT-A2LA-R&E220300105A-BLE

3.2. TEST DESCRIPTION

3.2.1. MEASUREMENT UNCERTAINTY

The reported uncertainty of measurement $y \pm U$, where expanded uncertainty U is based on a standard uncertainty multiplied by a coverage factor of $k=2$, providing a level of confidence of approximately 95 %.

No.	Item	Uncertainty
1	Conducted Emission Test	$\pm 3.2\text{dB}$
2	RF power,conducted	$\pm 0.16\text{dB}$
3	Spurious emissions,conducted	$\pm 0.21\text{dB}$
4	All emissions,radiated(<1G)	$\pm 4.7\text{dB}$
5	All emissions,radiated(>1G)	$\pm 4.7\text{dB}$
6	Temperature	$\pm 0.5^\circ\text{C}$
7	Humidity	$\pm 2\%$





3.2.2. DESCRIPTION OF TEST MODES

To investigate the maximum EMI emission characteristics generates from EUT, the test system was pre-scanning tested base on the consideration of following EUT operation mode or test configuration mode which possible have effect on EMI emission level. Each of these EUT operation mode(s) or test configuration mode(s) mentioned above was evaluated respectively.

Pretest Mode	Description
Mode 1	CH37
Mode 2	CH20
Mode 3	CH39
Mode 4	Normal

For Conducted Emission	
Final Test Mode	Description
Mode 4	Normal

For Radiated Emission	
Final Test Mode	Description
Mode 1	CH37
Mode 2	CH20
Mode 3	CH39

Note:

- (1) The measurements are performed at the highest, middle, lowest available channels.
- (2) Record the worst case of each test item in this report.
- (3) When we test it, the duty cycle $\geq 98\%$





3.2.3. Table of Parameters of Text Software Setting

During testing channel & power controlling software provided by the customer was used to control the operating channel as well as the output power level. The RF output power selection is for the setting of RF output power expected by the customer and is going to be fixed on the firmware of the final end product power parameters.

Test software Version	N/A		
Frequency	2402 MHz	2440 MHz	2480 MHz
Parameters(1Mbps)	DEF	DEF	DEF

3.2.4. CONFIGURATION OF SYSTEM UNDER TEST

Mode 1:

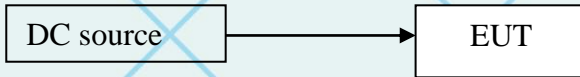

Mode 2:



(EUT: LCD monitors)





3.3. DESCRIPTION OF SUPPORT UNITS (CONDUCTED MODE)

The EUT has been tested as an independent unit together with other necessary accessories or support units. The following support units or accessories were used to form a representative test configuration during the tests.

Item	Equipment	Mfr/Brand	Model/Type No.	Series No.	Note
1	DC source	/	/	/	/
2	Camera	/	/	/	/

Note:

- (1) All the equipment/cables were placed in the worst-case configuration to maximize the emission during the test.
- (2) Grounding was established in accordance with the manufacturer's requirements and conditions for the intended use.





3.4. SUMMARY OF TEST RESULTS

Test procedures according to the technical standards:

FCC Part15 (15.247) , Subpart C			
Standard Section	Test Item	Judgment	Remark
15.203	Antenna Requirement	PASS	
15.207	Conducted Emission	PASS	
15.209, 15.205, 15.247(d)	Spurious Emission	PASS	
15.247(a) (2)	6dB Bandwidth Testing	PASS	
15.247(b) (3)	Maximum Peak Output Power	PASS	
15.247(d)	100 KHz Bandwidth of Frequency Band Edge	PASS	
15.247(e)	Maximum Conducted Power Spectral Density	PASS	

NOTE:

(1) "N/A" denotes test is not applicable in this test report.





4. MEASUREMENT INSTRUMENTS

NAME OF EQUIPMENT	MANUFACTURER	MODEL	SERIAL NUMBER	Calibration Date	Calibration Due.
EMI Test Receiver	R&S	ESCI	100005	11/05/2021	11/04/2022
LISN	AFJ	LS16	16010222119	11/05/2021	11/04/2022
LISN(EUT)	Mestec	AN3016	04/10040	11/05/2021	11/04/2022
Universal Radio Communication Tester	R&S	CMU 200	1100.0008.02	11/05/2021	11/04/2022
Coaxial cable	Megalon	LMR400	N/A	11/05/2021	11/04/2022
GPIB cable	Megalon	GPIB	N/A	11/05/2021	11/04/2022
Spectrum Analyzer	R&S	FSU	100114	11/05/2021	11/04/2022
Pre Amplifier	H.P.	HP8447E	2945A02715	11/05/2021	11/04/2022
Pre-Amplifier	CDSI	PAP-1G18-38	--	11/05/2021	11/04/2022
Bi-log Antenna	SUNOL Sciences	JB3	A021907	11/05/2021	11/04/2022
9*6*6 Anechoic	--	--	--	11/05/2021	11/04/2022
Horn Antenna	COMPLIANCE ENGINEERING	CE18000	--	11/05/2021	11/04/2022
Horn Antenna	SCHWARZBECK	BBHA9120D	9120D-631	11/05/2021	11/04/2022
Cable	TIME MICROWAVE	LMR-400	N-TYPE04	11/05/2021	11/04/2022
System-Controller	CCS	N/A	N/A	N.C.R	N.C.R
Turn Table	CCS	N/A	N/A	N.C.R	N.C.R
Antenna Tower	CCS	N/A	N/A	N.C.R	N.C.R
RF cable	Murata	MXHQ87WA3000	-	11/05/2021	11/04/2022
Loop Antenna	EMCO	6502	00042960	11/05/2021	11/04/2022
Horn Antenna	SCHWARZBECK	BBHA 9170	1123	11/05/2021	11/04/2022
Power meter	Anritsu	ML2487A	6K00003613	11/05/2021	11/04/2022
Power sensor	Anritsu	MX248XD	--	11/05/2021	11/04/2022





5. ANTENNA REQUIREMENT

5.1. Standard Applicable

According to § 15.203, an intentional radiator shall be designed to ensure that no antenna other than that furnished by the responsible party shall be used with the device. The use of a permanently attached antenna or of an antenna that uses a unique coupling to the intentional radiator shall be considered sufficient to comply with the provisions of this section. The manufacturer may design the unit so that a broken antenna can be replaced by the user, but the user of a standard antenna jack or electrical connector is prohibited. The structure and application of the EUT were analyzed to determine compliance with section §15.203 of the rules. §15.203 state that the subject device must meet the following criteria:

- a. Antenna must be permanently attached to the unit.
- b. Antenna must use a unique type of connector to attach to the EUT.

Unit must be professionally installed, and installer shall be responsible for verifying that the correct antenna is employed with the unit.

And according to FCC 47 CFR section 15.247 (b), if the transmitting antennas of directional gain greater than 6dBi are used, the power shall be reduced by the amount in dB that the directional gain of the antenna exceeds 6 dBi.

5.2. Antenna Connector Construction

The EUT's antenna RP-SMA Antenna, The antenna's gain is 0.78dBi and meets the requirement.





6. CONDUCTED EMISSIONS

6.1.1. Applicable Standard

The specification used was with the FCC Part 15.207 limits.

6.1.2. Test Procedure

During the conducted emission test, the EUT was connected to the outlet of the LISN. Maximizing procedure was performed on the six (6) highest emissions of the EUT. All data was recorded in the Quasi-peak and average detection mode.

6.1.3. Test Conditions

Temperature:	26 °C
Relative Humidity:	60%
ATM Pressure:	100.0kPa
Voltage	120V/60Hz& 240V/50Hz





6.1.4. TEST RESULTS

NOTE: The EUT is powered by a DC source, so conducted emissions are not applicable.





7. SPURIOUS EMISSIONS

7.1.1. Test Equipment

Please refer to section 4 this report.

7.1.2. Test Procedure

The out of band emission tests were performed in the 3-meter chamber test site, using the setup accordance with the ANSI C63.4-2014. The specification used was the FCC Part Subpart C limits.

- a. The measuring distance of at 3 m shall be used for measurements at frequency up to 1GHz. For frequencies above 1GHz, any suitable measuring distance may be used.
- b. The EUT was placed on the top of a rotating table 0.8 meters above the ground at a 3 meter open area test site. The table was rotated 360 degrees to determine the position of the highest radiation.
- c. The height of the equipment or of the substitution antenna shall be 0.8 m; the height of the test antenna shall vary between 1 m to 4 m. Both horizontal and vertical polarizations of the antenna are set to make the measurement.
- d. The initial step in collecting conducted emission data is a spectrum analyzer peak detector mode pre-scanning the measurement frequency range. Significant peaks are then marked and then Quasi Peak detector mode re-measured.
- e. If the Peak Mode measured value compliance with and lower than Quasi Peak Mode Limit, the EUT shall be deemed to meet QP Limits and then no additional QP Mode measurement performed.
- f. For the actual test configuration, please refer to the related Item –EUT Test Photos.

Note:

***Both horizontal and vertical antenna polarities were tested
And performed pretest to three orthogonal axis. The worst case emissions were reported***

7.1.3. Environmental Conditions

Temperature:	26 °C
Relative Humidity:	55%
ATM Pressure:	100.0kPa



7.1.4. Radiated Test Setup

The system was investigated from 9 KHz to 25 GHz.

During the radiated emission test, the EMI test receiver & Spectrum Analyzer Setup were set with the following configurations:

Frequency Range	RBW	Video B/W	Detector
9KHz-30MHz	9kHz	30 kHz	QP
30 MHz – 1000 MHz	100 kHz	300 kHz	QP
1000 MHz – 25 GHz	1 MHz	3 MHz	PK
1000 MHz – 25 GHz	1 MHz	10 Hz	Ave

(A) Radiated Emission Test-Up Frequency Below 30MHz

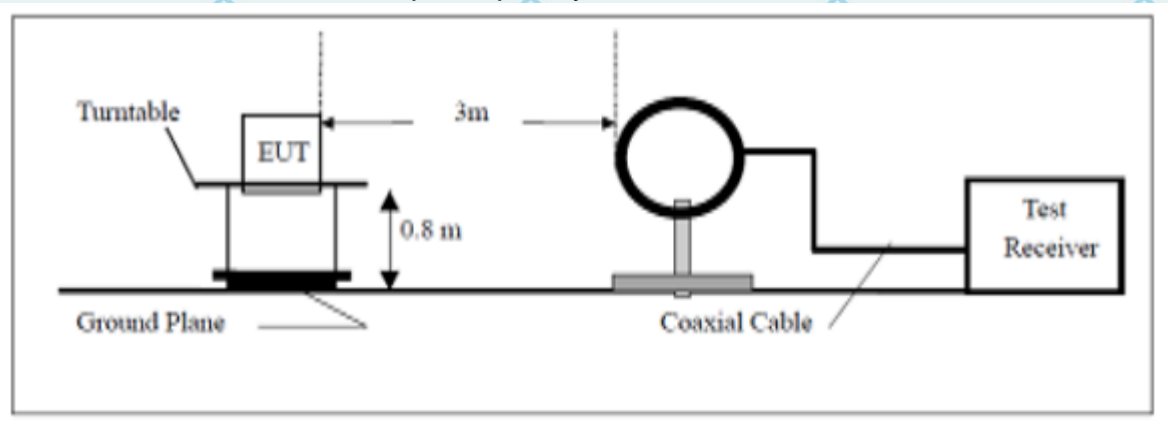

(B) Radiated Emission Test-Up Frequency 30MHz~1GHz

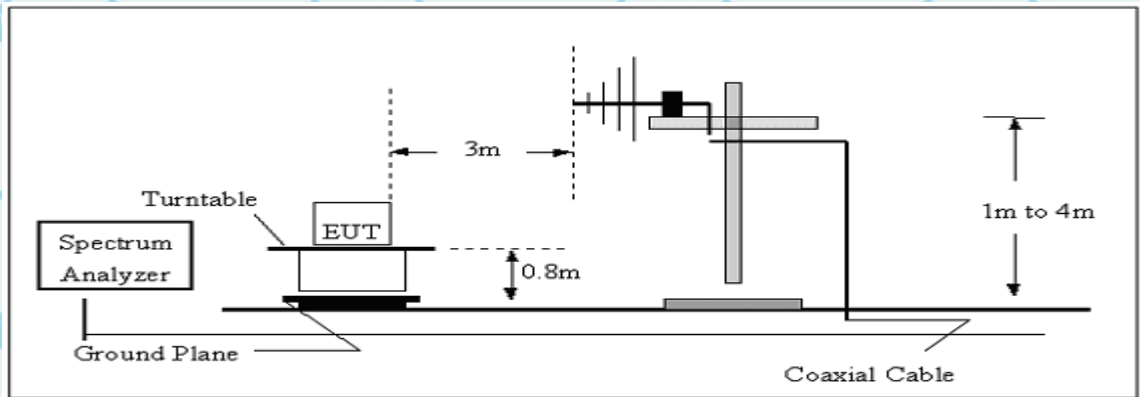



(C) Radiated Emission Test-Up Frequency Above 1GHz

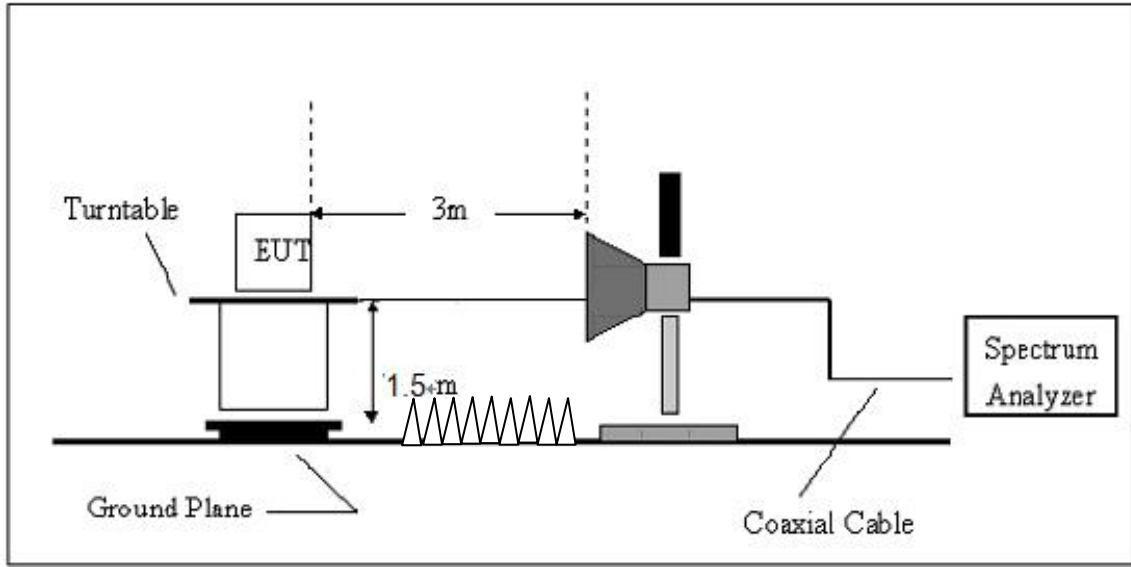

For the accrual test configuration, please refer to the related items-photos of Testing.





7.1.5. Radiated Emission Limit

Applicable Standard
FCC §15.247 (d); §15.209; §15.205;
Radiated Emission Test Result
Test Mode: Transmitting

Frequency (MHz)	Field strength (microvolts/meter)	Measurement distance (meters)
0.009–0.490	2400/F(kHz)	300
0.490–1.705	24000/F(kHz)	30
1.705–30.0	30	30
30–88	100**	3
88–216	150**	3
216–960	200**	3
Above 960	500	3

Note:

Both horizontal and vertical antenna polarities were tested and performed pretest to three orthogonal axis. The worst case emissions were reported

7.1.6. Test result:

From 9KHz to 30MHz

NOTE: 9KHz-30MHz the measurements were greater than 20dB below the limit.





Report No.: WSCT-A2LA-R&E220300105A-BLE
Frequency from 30MHz to 1GHz
Mode 4
Horizontal:



No.	Mk.	Freq. MHz	Reading Level dBuV	Correct Factor dB	Measure- ment dBuV/m	Limit dBuV/m	Over dB	Detector
1		53.8818	25.89	-5.48	20.41	40.00	-19.59	QP
2		145.3506	38.88	-4.65	34.23	43.50	-9.27	QP
3	!	222.9502	47.80	-5.95	41.85	46.00	-4.15	QP
4		298.2681	38.14	-2.33	35.81	46.00	-10.19	QP
5	*	499.9990	42.08	0.66	42.74	46.00	-3.26	QP
6	!	601.4265	41.14	1.45	42.59	46.00	-3.41	QP





Report No.: WSCT-A2LA-R&E220300105A-BLE
Vertical:

For Question,
 Please Contact with WSCT
 wsct-cert.com

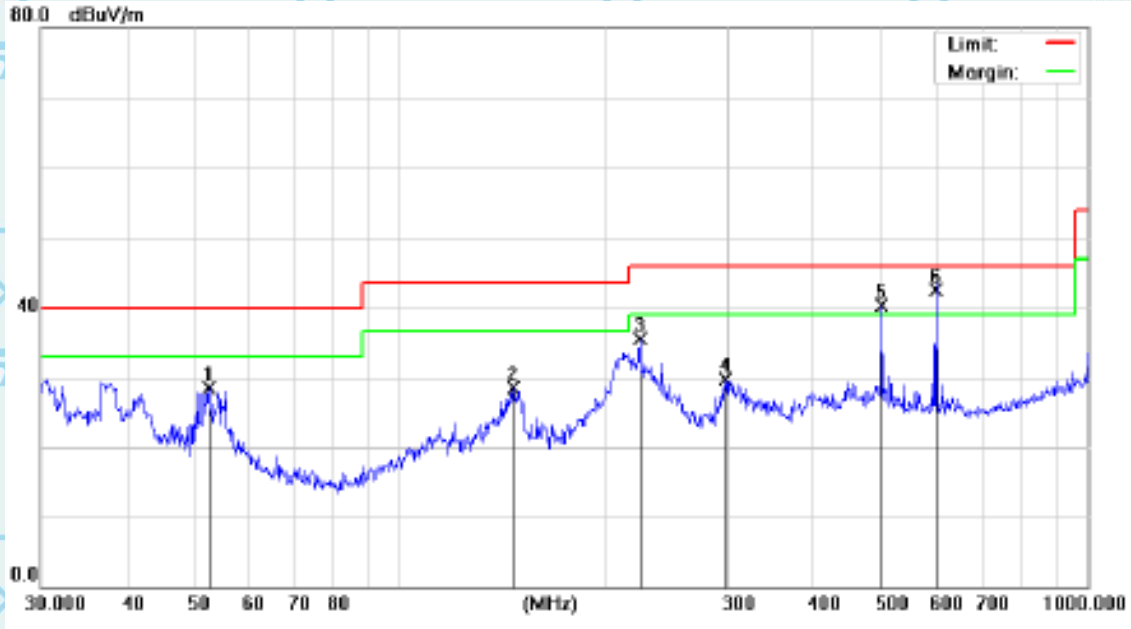

No.	Mk.	Freq. MHz	Reading Level dBuV	Correct Factor dB	Measurement dBuV/m	Limit dBuV/m	Over dB	Detector
1		52.5753	33.76	-5.33	28.43	40.00	-11.57	QP
2		145.8611	33.18	-4.68	28.50	43.50	-15.00	QP
3		222.9502	41.44	-5.95	35.49	46.00	-10.51	QP
4		297.2241	32.09	-2.38	29.71	46.00	-16.29	QP
5	!	501.1790	39.72	0.67	40.39	46.00	-5.61	QP
6	*	601.4265	41.15	1.45	42.60	46.00	-3.40	QP

Note: 1.All the modes have been investigated, and only worst mode is presented in this report.
 2.Over=Reading Level+ Correct Factor - Limit.



7.1.7. From 1GHz to 25GHz:

Operation Mode:	Channel 0	Measured Distance:	3m
Frequency Range:	Above 1GHz	Temperature :	28°C
Test Result:	PASS	Humidity :	65 %

Freq. (MHz)	Ant.Pol .	Emission Level(dBuV)		Limit 3m(dBuV/m)		Over(dB)	
		PK	AV	PK	AV	PK	AV
4804	V	58.98	41.41	74	54	-15.02	-12.59
7206	V	58.61	39.87	74	54	-15.39	-14.13
4804	H	59.92	40.09	74	54	-14.08	-13.91
7206	H	58.98	39.98	74	54	-15.02	-14.02

All emissions not reported were more than 20dB below the specified limit or in the noise floor.

- Note:**
- (1) All Readings are Peak Value and AV.
 - (2) Emission Level= Reading Level+ Probe Factor +Cable Loss.
 - (3) Data of measurement within this frequency range shown "--" in the table above means the reading of emissions are attenuated more than 20dB below the permissible limits or the field strength is too small to be measured.

Operation Mode:	Channel 20	Measured Distance:	3m
Frequency Range:	Above 1GHz	Temperature :	28°C
Test Result:	PASS	Humidity :	65 %

Freq. (MHz)	Ant.Pol .	Emission Level(dBuV)		Limit 3m(dBuV/m)		Over(dB)	
		PK	AV	PK	AV	PK	AV
4880	V	59.25	39.47	74	54	-14.75	-14.53
7320	V	58.66	39.50	74	54	-15.34	-14.50
4880	H	59.57	40.29	74	54	-14.43	-13.71
7320	H	59.14	40.14	74	54	-14.86	-13.86

All emissions not reported were more than 20dB below the specified limit or in the noise floor.

- Note:**
- (1) All Readings are Peak Value and AV.
 - (2) Emission Level= Reading Level+Probe Factor +Cable Loss.
 - (3) Data of measurement within this frequency range shown "--" in the table above means the reading of emissions are attenuated more than 20dB below the permissible limits or the field strength is too small to be measured.





Operation Mode:	Channel 39	Measured Distance:	3m
Frequency Range:	Above 1GHz	Temperature :	28°C
Test Result:	PASS	Humidity :	65 %

Freq. (MHz)	Ant.Pol	Emission Level(dBuV)		Limit 3m(dBuV/m)		Over(dB)	
		PK	AV	PK	AV	PK	AV
4960	V	60.32	39.90	74	54	-13.68	-14.10
7440	V	59.23	40.92	74	54	-14.77	-13.08
4960	H	59.21	40.80	74	54	-14.79	-13.20
7440	H	59.08	40.08	74	54	-14.92	-13.92

All emissions not reported were more than 20dB below the specified limit or in the noise floor.

- Note:**
- (1) All Readings are Peak Value and AV.
 - (2) Emission Level= Reading Level+Probe Factor +Cable Loss.
 - (3) Data of measurement within this frequency range shown “ -- ” in the table above means the reading of emissions are attenuated more than 20dB below the permissible limits or the field strength is too small to be measured.





8. -6dB BANDWIDTH TESTING

8.1.1. Test Equipment

Please refer to Section 4 this report.

8.1.2. Test Procedure

1. Set EUT in the transmitting mode.
2. Remove the antenna from the EUT and then connect a low loss RF cable from the antenna port to the spectrum analyzer.
3. Set the spectrum analyzer as RBW=100KHz,VBW≥RBW, Span=3MHz,Sweep=auto.
4. Mark the peak frequency and -6dB(upper and lower)frequency.
5. Repeat until all the rest channels are investigated.

Note : The EUT was tested according to KDB 558074 for compliance to FCC 47CFR 15.247 requirements.

8.1.3. Environmental Conditions

Temperature:	26 °C
Relative Humidity:	55%
ATM Pressure:	100.0kPa

8.1.4. Applicable Standard

Systems using digital modulation techniques may operate in the 902–928 MHz, 2400–2483.5 MHz, and 5725–5850 MHz bands. The minimum 6 dB bandwidth shall be at least 500 kHz.





8.1.5. Test Result: Pass.

Please refer to the following tables

Channel Frequency (MHz)	Data Rate (Mbps)	6dB Bandwidth (kHz)	Limit (kHz)	Ref. Plot
2402	1	649	> 500	PLOT 1
2440	1	649	> 500	PLOT 2
2480	1	654	> 500	PLOT 3

Low Channel

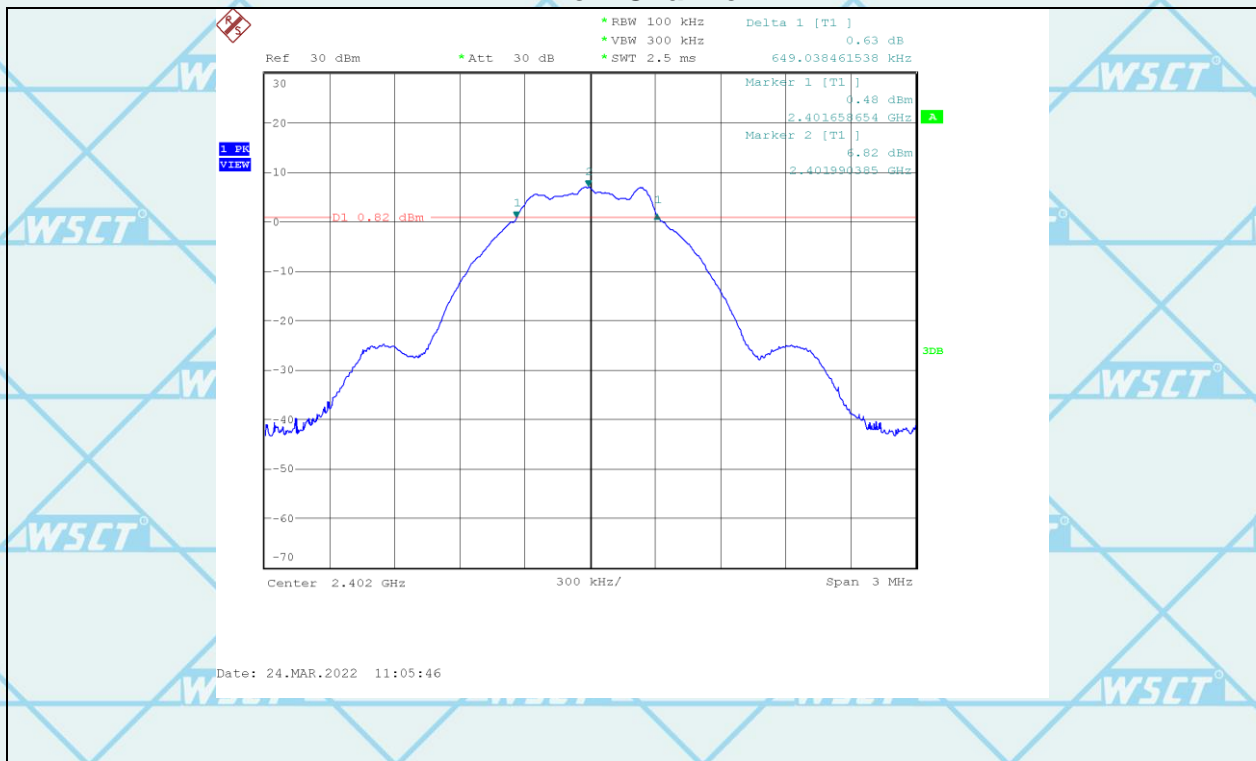



For Question,
Please Contact with WSCT
www.wsct-cert.com

Middle channel

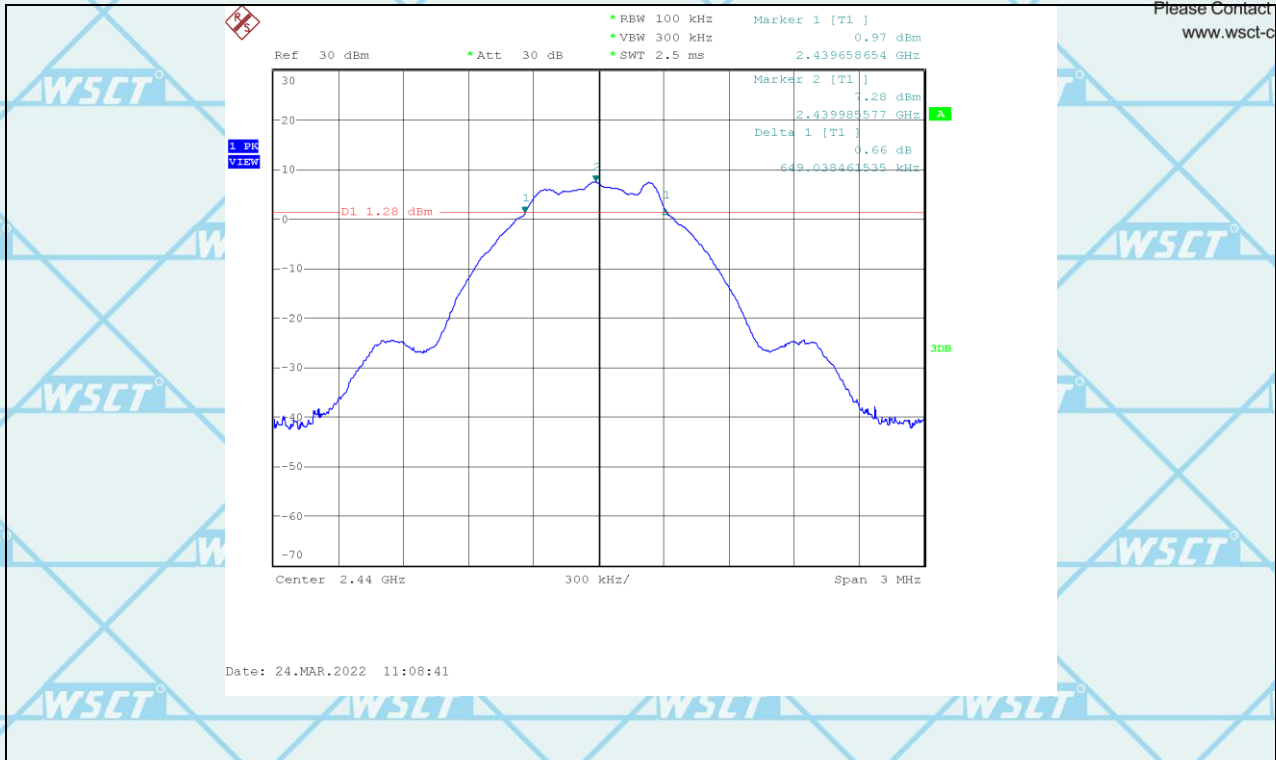

High Channel

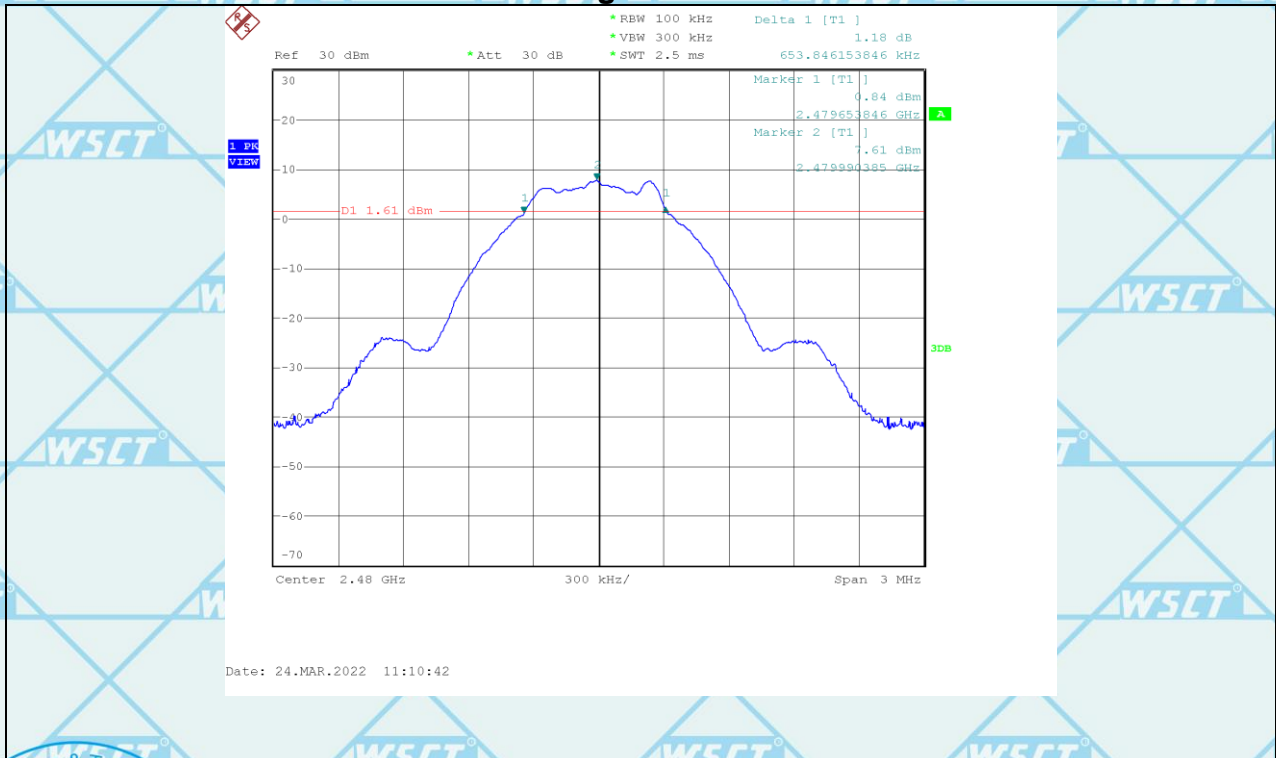



For Question,
Please Contact with WSCT
www.wsct-cert.com

Report No.: WSCT-A2LA-R&E220300105A-BLE

9. MAXIMUM PEAK OUTPUT POWER

9.1.1. Test Equipment

Please refer to Section 4 this report.

9.1.2. Test Procedure

1. The EUT was directly connected to the spectrum analyzer and antenna output port as show in the block diagram below,
2. Set the EUT Work on the top, the middle and the bottom operation frequency individually.
3. Set the RBW =1MHz, VBW \geq 3RBW, span \geq 1.5*6dbbandwith.
Sweep time = auto couple, Detector = peak, Trace mode = max hold.
4. Record the maximum power from the spectrum analyzer.
5. The maximum peak power shall be less 1 Watt (30dBm).

Note : The EUT was tested according to KDB 558074 for compliance to FCC 47CFR 15.247 requirements.

9.1.3. Environmental Conditions

Temperature:	26 °C
Relative Humidity:	55%
ATM Pressure:	100.0kPa

9.1.4. Applicable Standard

According to §15.247(b) (3), for systems using digital modulation in the 902–928 MHz, 2400–2483.5 MHz, and 5725–5850 MHz bands: 1 Watt. As an alternative to a peak power measurement, compliance with the one Watt limit can be based on a measurement of the maximum conducted output power. Maximum Conducted Output Power is defined as the total transmit power delivered to all antennas and antenna elements averaged across all symbols in the signaling alphabet when the transmitter is operating at its maximum power control level. Power must be summed across all antennas and antenna elements. The average must not include any time intervals during which the transmitter is off or is transmitting at a reduced power level. If multiple modes of operation are possible (e.g., alternative modulation methods), the maximum conducted output power is the highest total transmit power occurring in any mode.





9.1.5. Test Result

Channel	Frequency (MHz)	Data Rate (Mbps)	Conducted Power (dBm)	Limit (dBm)
Low	2402	1	7.84	30
Middle	2440	1	8.83	30
High	2480	1	8.98	30

Low channel

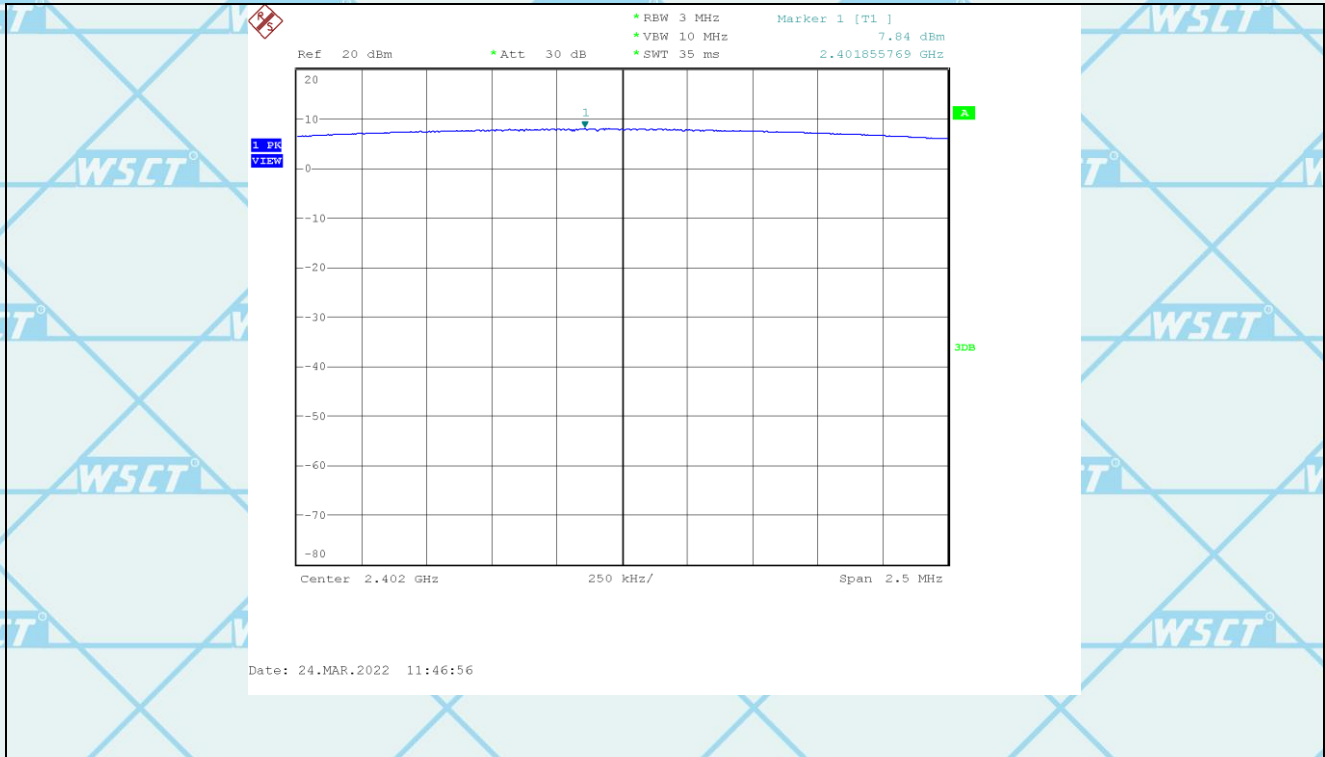



For Question,
Please Contact with WSCT
www.wsct-cert.com

Middle channel

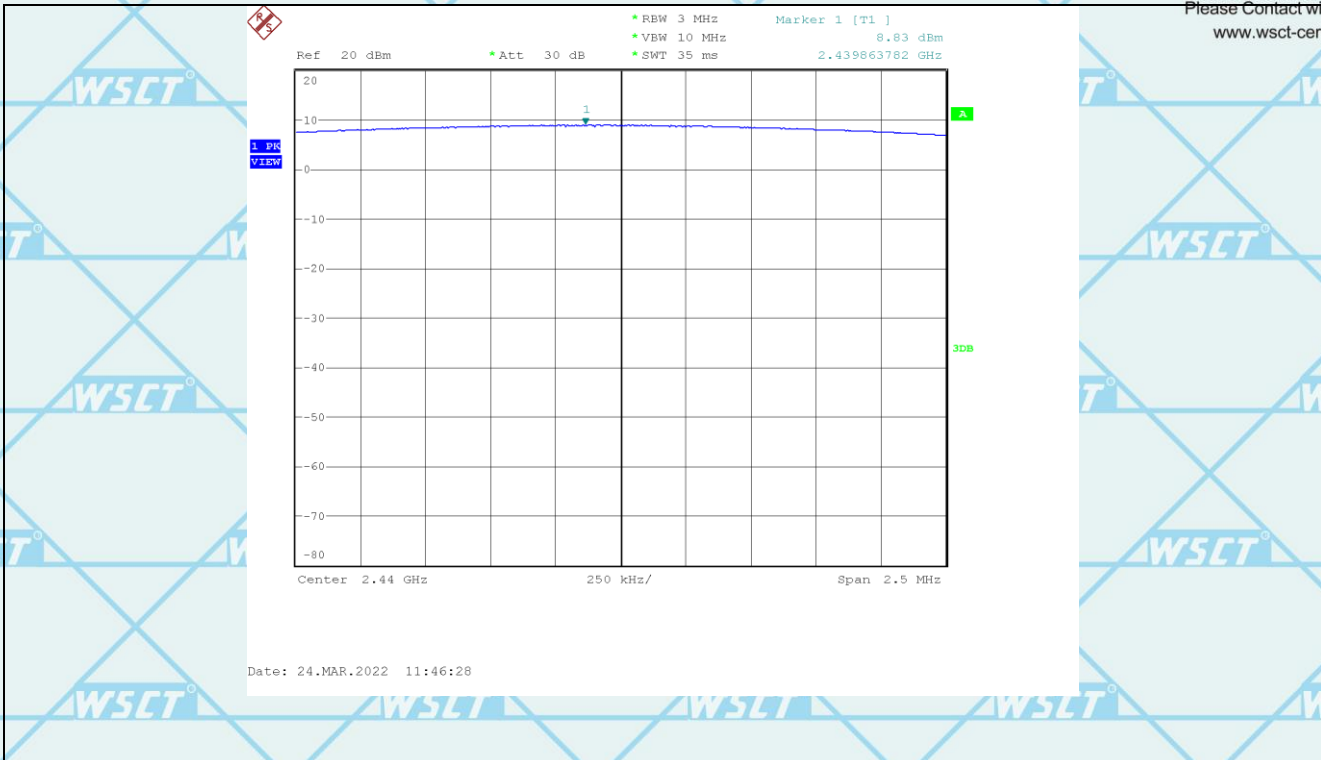

High channel

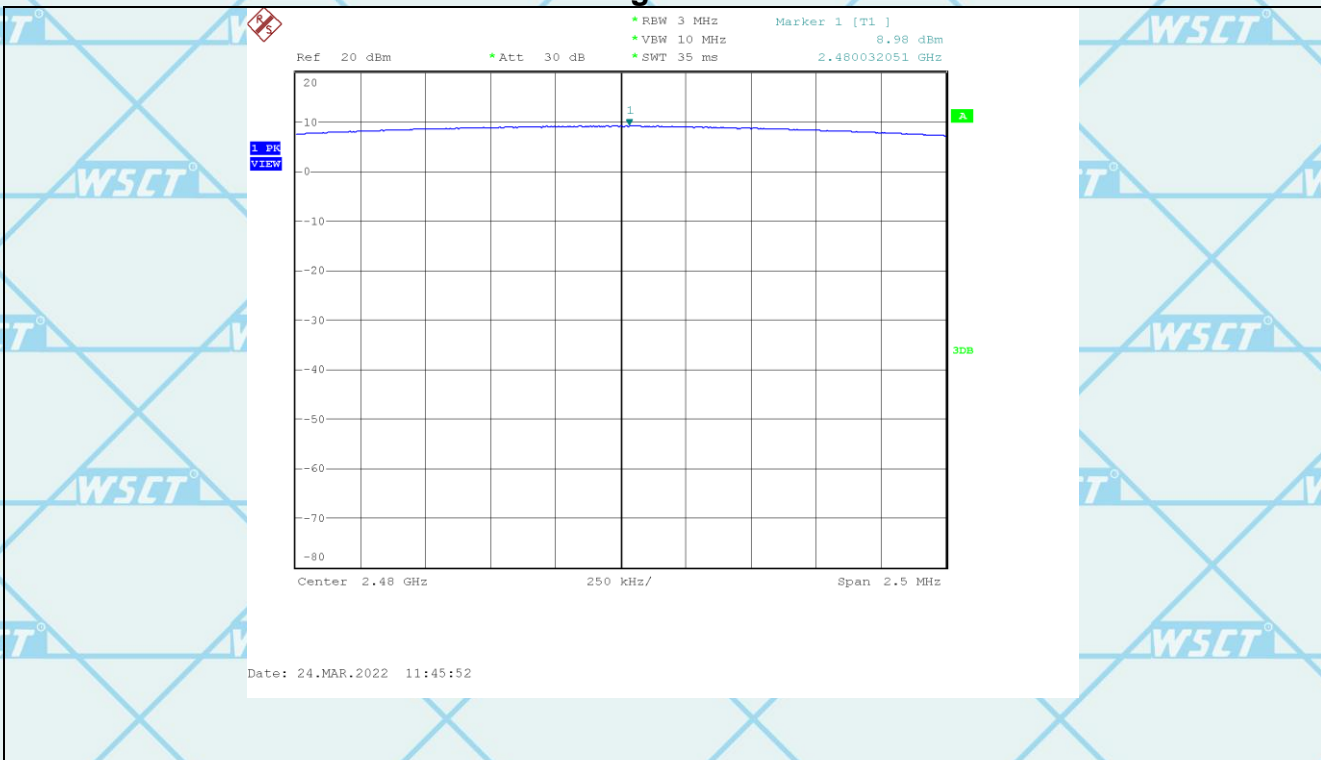



10. 100 kHz Bandwidth of Frequency Band Edge

10.1.1. Test Equipment

Please refer to Section 4 this report.

10.1.2. Test Procedure

The out of band emission tests were performed in the 3-meter chamber test site, using the setup accordance with the ANSI C63.4-2014. The specification used was the FCC Part Subpart C limits.

10.1.3. Environmental Conditions

Temperature:	26 °C
Relative Humidity:	55%
ATM Pressure:	100.0kPa

10.1.4. Applicable Standard

In any 100 kHz bandwidth outside the frequency band in which the spread spectrum or digitally modulated intentional radiator is operating, the radio frequency power that is produced by the intentional radiator shall be at least 20 dB below that in the 100 kHz bandwidth within the band that contains the highest level of the desired power, based on either an RF conducted or a radiated measurement, provided the transmitter demonstrates compliance with the peak conducted power limits. If the transmitter complies with the conducted power limits based on the use of RMS averaging over a time interval, as permitted under paragraph (b)(3) of this section, the attenuation required under this paragraph shall be 30 dB instead of 20 dB. Attenuation below the general limits specified in §15.209(a) is not required. In addition, radiated emissions which fall in the restricted bands, as defined in §15.205(a), must also comply with the radiated emission limits specified in §15.209(a) (see §15.205(c)).





10.1.5. Test Result: PASS

Radiated measurement:

Indicated		result (PK/AV)	Table Angle Degree	Antenna		Correction Factor			FCC Part 15.247			
Frequency (MHz)	Receiver Reading (dBμV/m)			Height (m)	Polar (H/V)	Ant. Factor (dB/m)	Cable Loss (dB)	Pre-Amp. Gain (dB)	Cord. Amp. (dBμV/m)	Limit (dBμV/m)	Margin (dB)	
Low Channel (2402MHz)												
2390	40.23	AV	225	1.5	V	30.3	4.1	33.1	41.53	54	12.47	
2390	41.65	AV	90	2	H	30.3	4.1	33.1	40.35	54	11.05	
2390	61.13	PK	180	1.5	V	30.3	4.1	33.1	41.53	74	11.57	
2390	61.34	PK	270	2	H	30.3	4.1	33.1	62.64	74	11.36	
High Channel (2480MHz)												
2483.5	41.09	AV	360	1	V	31	4.4	32.7	43.79	54	10.21	
2483.5	41.14	AV	90	2	H	31	4.4	32.7	43.84	54	10.16	
2483.5	60.32	PK	180	1	V	31	4.4	32.7	63.02	74	10.98	
2483.5	60.36	PK	225	2	H	31	4.4	32.7	63.06	74	10.94	

Conducted Emission Measurement:

Low channel

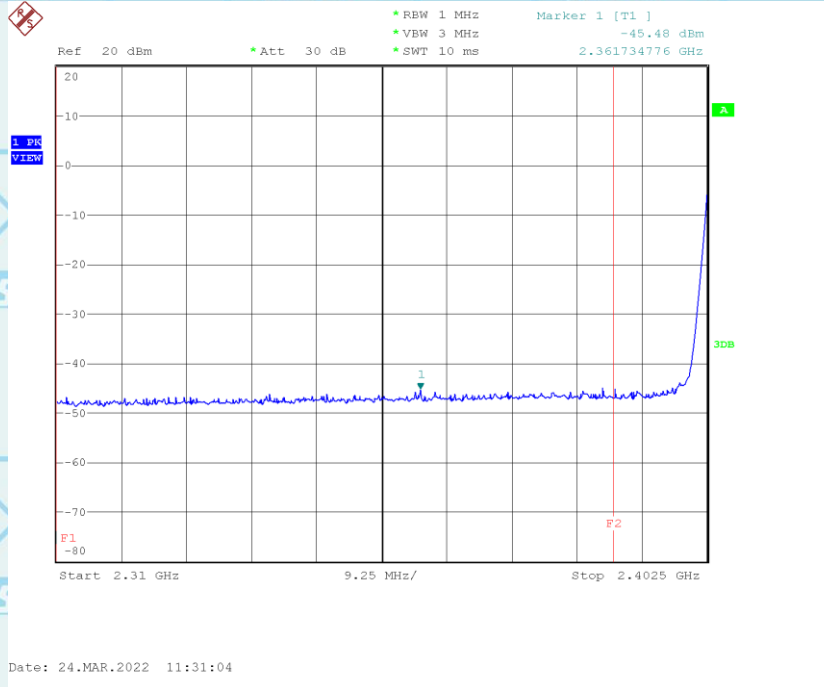



For Question, Please Contact with WSCT www.wsct-cert.com

High channel

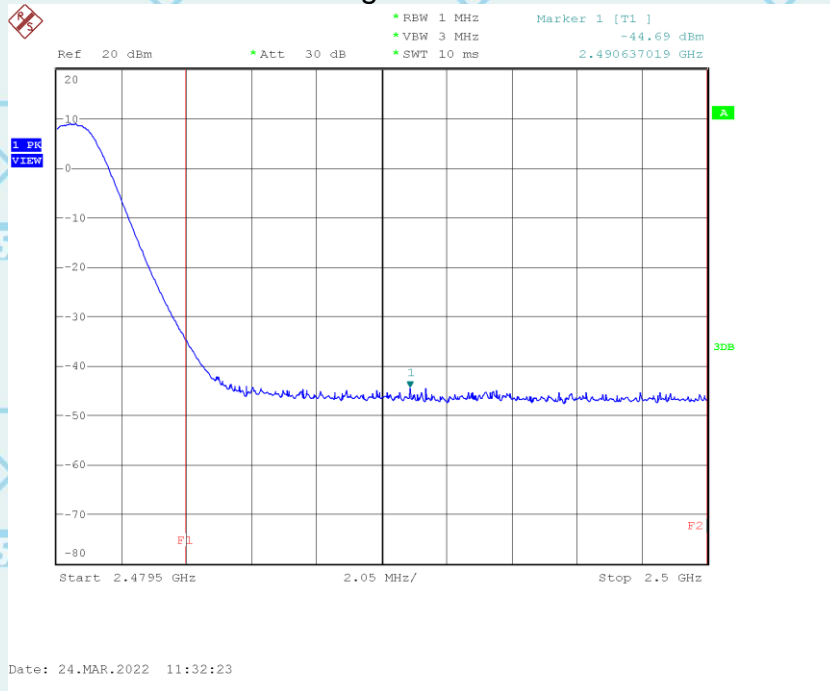

Conducted spurious emissions

Channel Low

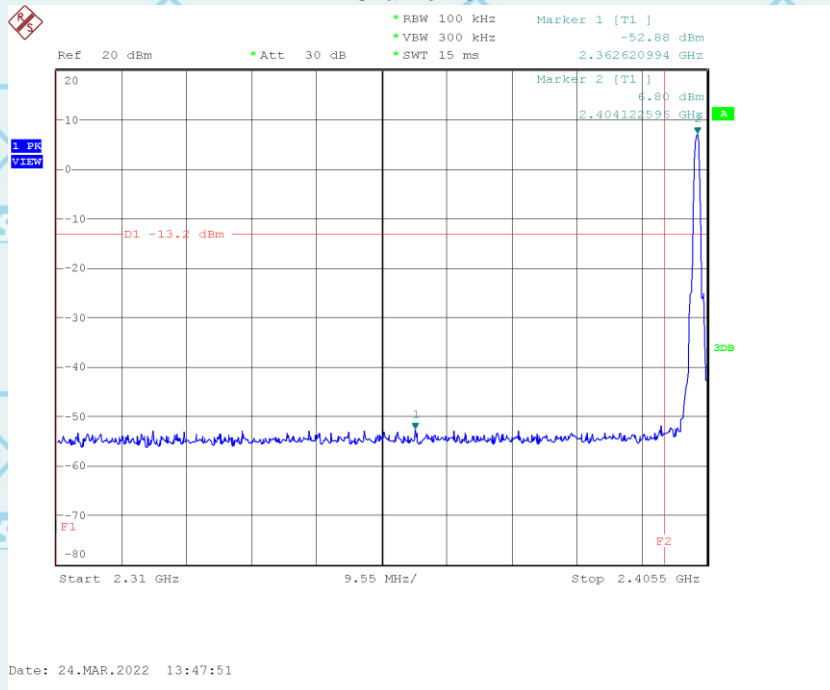



For Question, Please Contact with WSCT www.wsct-cert.com

Channel Mid

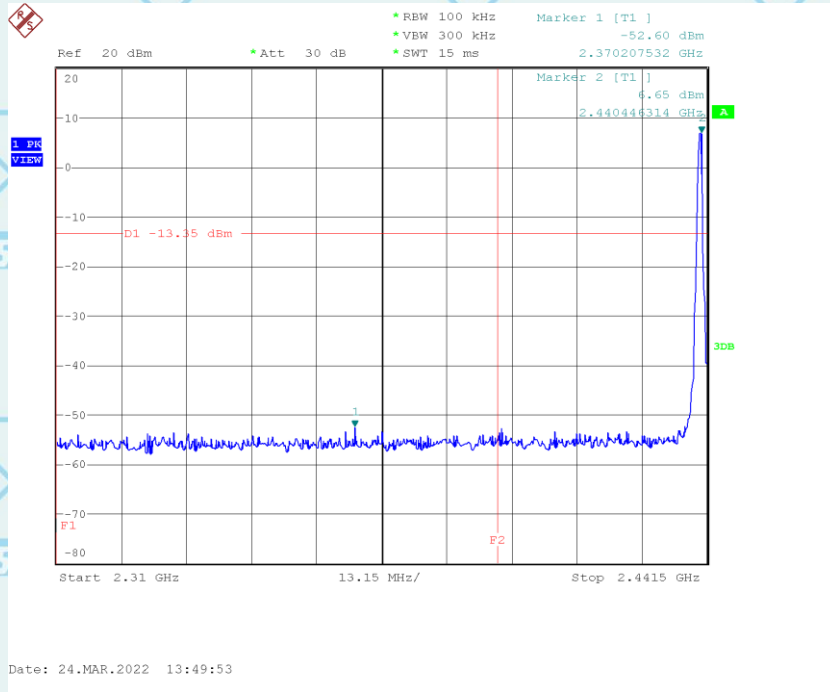

Channel High

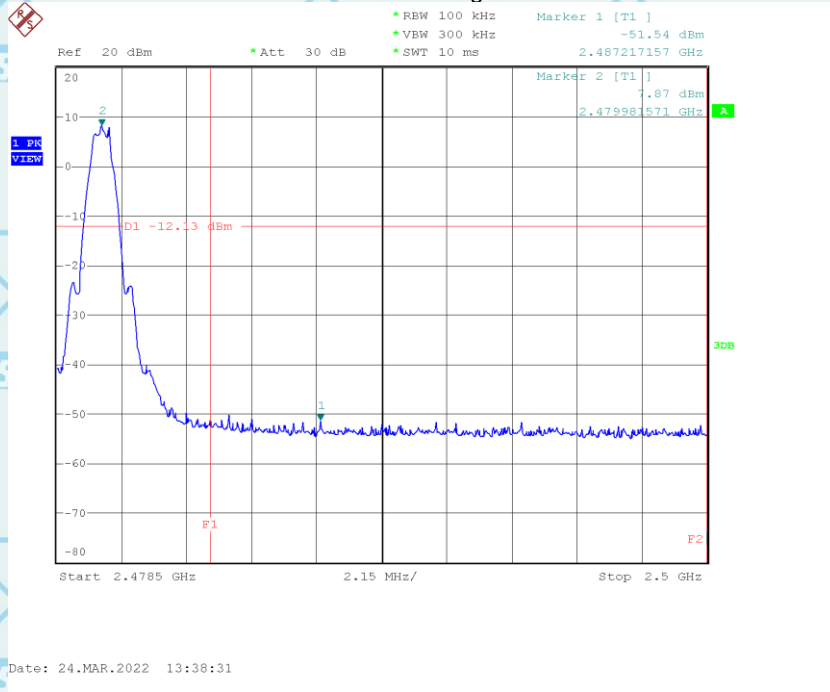



11. MAXIMUM CONDUCTED POWER SPECTRAL DENSITY

11.1.1. Test Equipment

Please refer to Section 4 this report.

11.1.2. Test Procedure

- 1, This procedure shall be used if maximum peak conducted output power was used to demonstrate compliance, and is optional if the maximum conducted (average) output power was used to demonstrate compliance.
- 2, Set analyzer center frequency to DTS channel center frequency.
- 3, Set the RBW to: 3 kHz \leq RBW \leq 100 kHz, Set the VBW \geq 3 RBW, Detector = peak. Sweep time = auto couple
- 4, Trace mode = max hold, Allow trace to fully stabilize.

Note : The EUT was tested according to KDB 558074 for compliance to FCC 47CFR 15.247 requirements.

11.1.3. Environmental Conditions

Temperature:	25 °C
Relative Humidity:	55%
ATM Pressure:	100.0kPa

11.1.4. Applicable Standard

For digitally modulated systems, the power spectral density conducted from the intentional radiator to the antenna shall not be greater than 8 dBm in any 3 kHz band during any time interval of continuous transmission. This power spectral density shall be determined in accordance with the provisions of paragraph (b) of this section. The same method of determining the conducted output power shall be used to determine the power spectral density.





11.1.5. Test Result

PASS

For Question,
Please Contact with WSCT
www.wsct-cert.com

Channel Frequency (MHz)	Data Rate (Mbps)	PSD (dBm/3kHz)	Limit (dBm/3kHz)	RESULT
2402	1	-13.96	8	Compliant
2440	1	-12.80	8	Compliant
2480	1	-12.46	8	Compliant

Low Channel

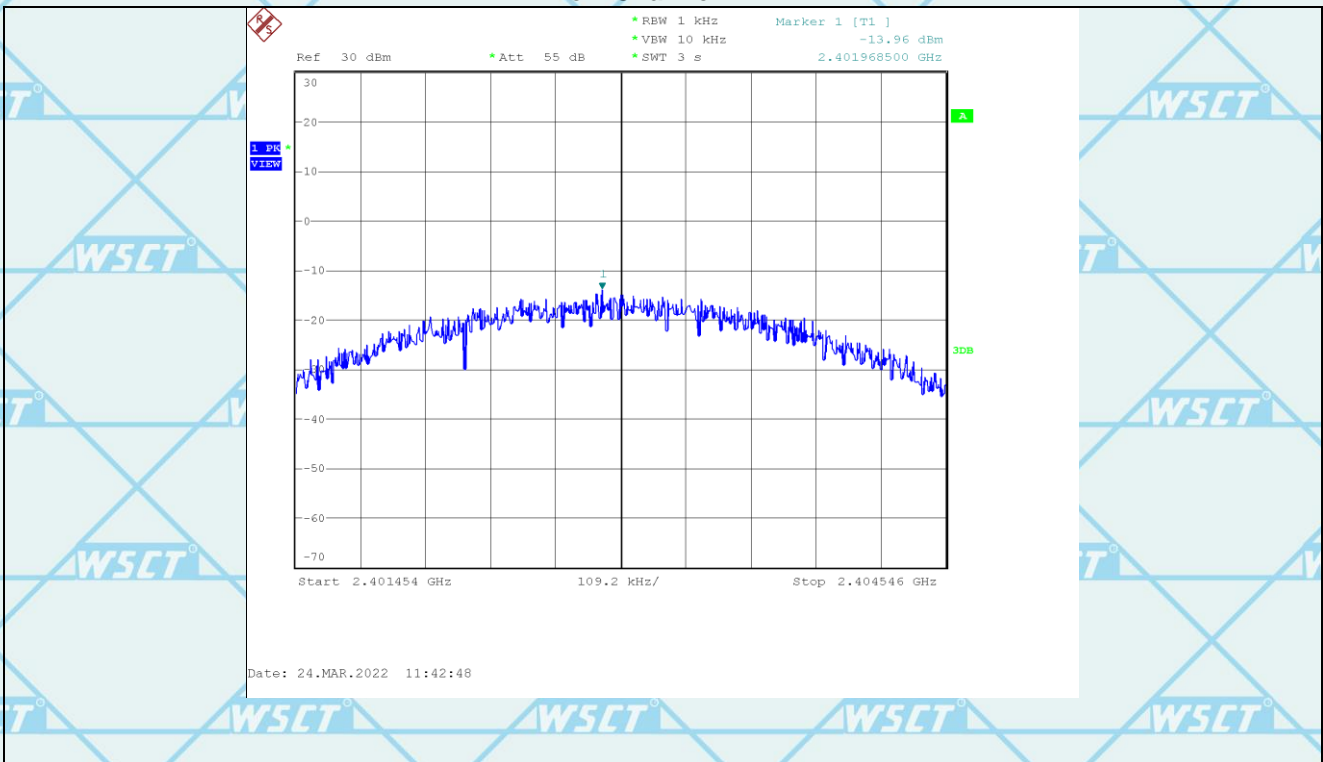



Middle Channel

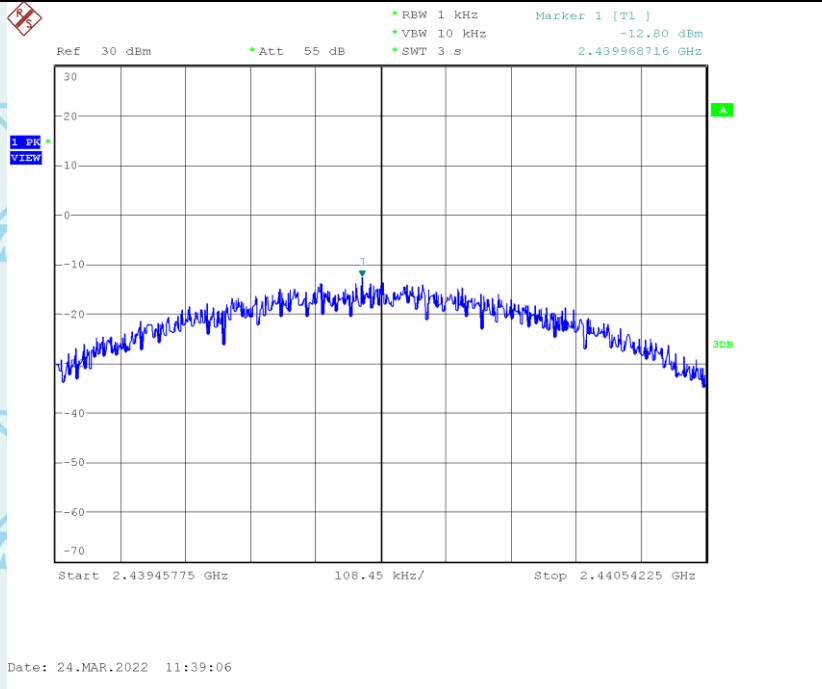

High Channel

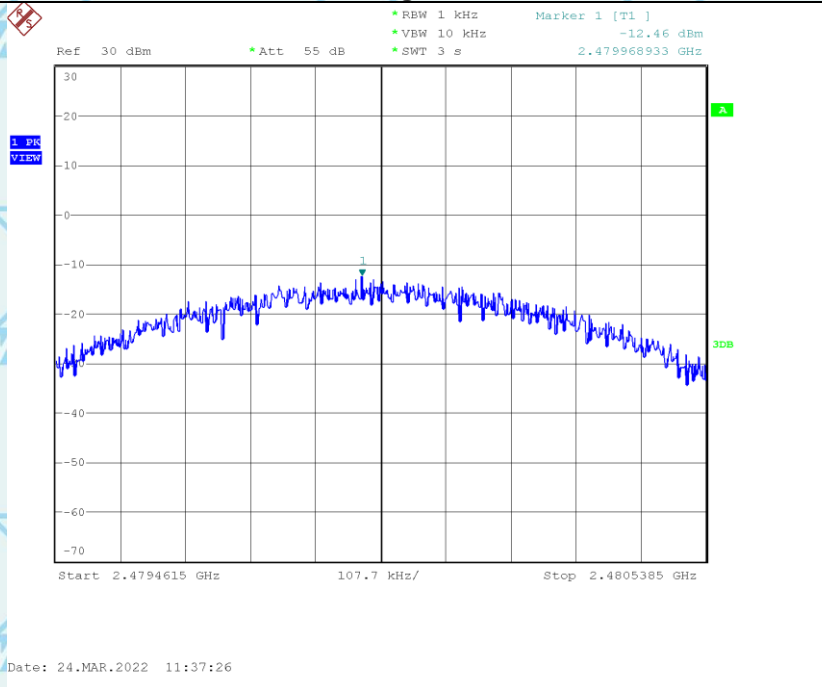

—END OF REPORT—

