



**Shenzhen Global Test Service Co.,Ltd.**

No.7-101 and 8A-104, Building 7 and 8, DCC Cultural and Creative Garden, No.98, Pingxin North Road, Shangmugu Community, Pinghu Street, Longgang District, Shenzhen, Guangdong

## FCC PART 15 SUBPART C TEST REPORT

### FCC PART 15 C(15.249)

**Report Reference No.....: GTS20220523004-1-5**

**FCC ID.....: 2A5PO3711-1A**

Compiled by

( position+printed name+signature) .: File administrators Peter Xiao

Supervised by

( position+printed name+signature) .: Test Engineer Jenny Zeng

Approved by

( position+printed name+signature) .: Manager Simon Hu



Date of issue .....: Jun. 07, 2022

**Representative Laboratory Name.: Shenzhen Global Test Service Co.,Ltd**

Address .....: No.7-101 and 8A-104, Building 7 and 8, DCC Cultural and Creative Garden, No.98, Pingxin North Road, Shangmugu Community, Pinghu Street, Longgang District, Shenzhen, Guangdong,China

**Applicant's name.....: SHANTOU CITY OURUI INDUSTRIAL Co., LTD**

Address .....: NO. 2, XIAOJIAN ROAD, SHANGKENG COMMUNITY, GUANGYI STREET, CHENGHAI DISTRICT, SHANTOU CITY, GUANGDONG PROVINCE, CHINA

**Test specification .....**

Standard.....: **FCC CFR 47 PART 15 C(15.249)**  
**ANSI C63.10-2013**

TRF Originator.....: Shenzhen Global Test Service Co.,Ltd.

Master TRF .....: Dated 2014-12

**Shenzhen Global Test Service Co.,Ltd. All rights reserved.**

This publication may be reproduced in whole or in part for non-commercial purposes as long as the Shenzhen Global Test Service Co.,Ltd. is acknowledged as copyright owner and source of the material. Shenzhen Global Test Service Co.,Ltd. takes no responsibility for and will not assume liability for damages resulting from the reader's interpretation of the reproduced material due to its placement and context.

**Test item description .....**

Trade Mark.....: N/A

Manufacturer .....: SHANTOU CITY OURUI INDUSTRIAL Co., LTD

Model/Type reference .....: 3710-1A

Listed Models .....: 3710-2A, 3711-1A, 3711-2A, 3711-3A, 3712-1A, 3712-2A, 3712-3A, 3713-1A, 3713-2A

Modulation Type.....: GFSK

Operation Frequency.....: From 2405-2475MHz

Hardware Version .....: N/A

Software Version.....: N/A

Rating .....: DC 3.0V by AA\*2

Result .....: **PASS**

**TEST REPORT**

<b>Test Report No. :</b>	<b>GTS20220523004-1-5</b>	Jun. 07, 2022
		Date of issue

Equipment under Test : Mosasaurus dinosaur

Model /Type : 3710-1A

Listed model : 3710-2A, 3711-1A, 3711-2A, 3711-3A, 3712-1A, 3712-2A, 3712-3A, 3713-1A, 3713-2A

**Applicant** : **SHANTOU CITY OURUI INDUSTRIAL Co., LTD**

Address : NO. 2, XIAOJIAN ROAD, SHANGKENG COMMUNITY, GUANGYI STREET, CHENGHAI DISTRICT, SHANTOU CITY, GUANGDONG PROVINCE, CHINA

**Manufacturer** : **SHANTOU CITY OURUI INDUSTRIAL Co., LTD**

Address : NO. 2, XIAOJIAN ROAD, SHANGKENG COMMUNITY, GUANGYI STREET, CHENGHAI DISTRICT, SHANTOU CITY, GUANGDONG PROVINCE, CHINA

<b>Test Result:</b>	<b>PASS</b>
---------------------	-------------

The test report merely corresponds to the test sample.  
It is not permitted to copy extracts of these test result without the written permission of the test laboratory.

## Contents

<b>1. TEST STANDARDS .....</b>	<b>4</b>
<b>2. SUMMARY .....</b>	<b>5</b>
2.1. General Remarks .....	5
2.2. Product Description .....	5
2.3. Equipment Under Test .....	6
2.4. Short description of the Equipment under Test (EUT) .....	6
2.5. EUT operation mode .....	6
2.6. Block Diagram of Test Setup .....	7
2.7. EUT Exercise Software .....	7
2.8. Special Accessories .....	7
2.9. External I/O Cable .....	7
2.10. Related Submittal(s) / Grant (s) .....	7
2.11. Modifications .....	7
<b>3. TEST ENVIRONMENT .....</b>	<b>8</b>
3.1. Address of the test laboratory .....	8
3.2. Test Facility .....	8
3.3. Environmental conditions .....	8
3.4. Statement of the measurement uncertainty .....	8
3.5. Test Description .....	9
3.6. Equipments Used during the Test.....	10
<b>4. TEST CONDITIONS AND RESULTS .....</b>	<b>11</b>
4.1. AC Power Conducted Emission .....	11
4.2. Radiated Emission .....	12
4.3. 20dB Bandwidth .....	17
4.4. Band Edge Compliance of RF Emission .....	19
4.5. Antenna Requirement .....	22
<b>5. TEST SETUP PHOTOS OF THE EUT .....</b>	<b>23</b>
<b>6. EXTERNAL AND INTERNAL PHOTOS OF THE EUT .....</b>	<b>24</b>

## 1. TEST STANDARDS

The tests were performed according to following standards:

[FCC Rules Part 15.249](#): Operation within the bands 902-928 MHz, 2400-2483.5 MHz, 5725-5875 MHz, and 24.0-24.25 GHz.

[ANSI C63.10-2013](#): American National Standard for Testing Unlicensed Wireless Devices

[KDB558074 D01 DTS Meas Guidance v05r02](#): Guidance for Performing Compliance Measurements on Digital Transmission Systems (DTS) Operating Under §15.247.

## 2. SUMMARY

### 2.1. General Remarks

Date of receipt of test sample	:	May.23, 2022
	:	
Testing commenced on	:	May.23, 2022
	:	
Testing concluded on	:	Jun. 07, 2022

### 2.2. Product Description

Product Name	Mosasaurus dinosaur
Trade Mark	N/A
Model/Type reference	3710-1A
List Models	3710-2A, 3711-1A, 3711-2A, 3711-3A, 3712-1A, 3712-2A, 3712-3A, 3713-1A, 3713-2A
Model Declaration	PCB board, structure and internal of these model(s) are the same, Only the model name different , So no additional models were tested.
Power supply:	DC 3.0V by AA*2
Sample ID	GTS20220523004-1-1#
<b>SRD</b>	
Frequency Range	2405-2475MHz
Channel Number	3Channels
Modulation Type	GFSK
Antenna Description	Internal Antenna, 1.50dBi(Max.)

### 2.3. Equipment Under Test

#### Power supply system utilised

Power supply voltage	:	<input type="radio"/>	230V / 50 Hz	<input type="radio"/>	120V / 60Hz
		<input type="radio"/>	12 V DC	<input type="radio"/>	24 V DC
		<input checked="" type="radio"/>	Other (specified in blank below)		

DC 3.0V

### 2.4. Short description of the Equipment under Test (EUT)

This is a Mosasaurus dinosaur .  
For more details, refer to the user's manual of the EUT.

### 2.5. EUT operation mode

Mode of Operations	Frequency Range (MHz)	Data Rate (Mbps)
SRD	2405	1
	2440	1
	2475	1
For Conducted Emission		
Test Mode		TX Mode
For Radiated Emission		
Test Mode		TX Mode

Channel	Frequency(MHz)
1	2405
2	2440
3	2475

The EUT has been tested under operating condition.

This test was performed with EUT in X, Y, Z position and the worst case was found when EUT in X position.

AC conducted emission pre-test at both at AC 120V/60Hz and AC 240V/60Hz modes, recorded worst case.

Worst-case mode and channel used for 150 KHz-30 MHz power line conducted emissions was the mode and channel with the highest output power, which was determined to be SRD mode.

Worst-case mode and channel used for 9 KHz-1000 MHz radiated emissions was the mode and channel with the highest output power, that was determined to be SRD mode.

**2.6. Block Diagram of Test Setup**

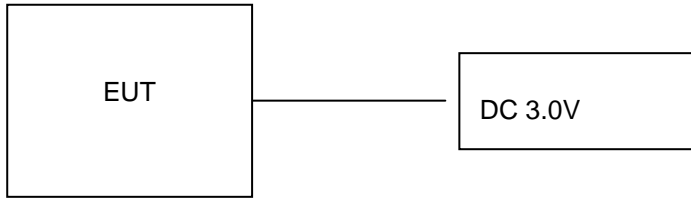

**2.7. EUT Exercise Software**

The product continues to transmit signals after power on.

**2.8. Special Accessories**

Manufacturer	Description	Model	Serial Number	Certificate
/	/	/	/	/

**2.9. External I/O Cable**

I/O Port Description	Quantity	Cable
/	/	/

**2.10. Related Submittal(s) / Grant (s)**

This submittal(s) (test report) is intended for **FCC ID: 2A5PO3711-1A** filing to comply with Section 15.247 of the FCC Part 15, Subpart C Rules.

**2.11. Modifications**

No modifications were implemented to meet testing criteria.

### 3. TEST ENVIRONMENT

#### 3.1. Address of the test laboratory

##### Shenzhen Global Test Service Co.,Ltd.

No.7-101 and 8A-104, Building 7 and 8, DCC Cultural and Creative Garden, No.98, Pingxin North Road, Shangmugu Community, Pinghu Street, Longgang District, Shenzhen, Guangdong,China.

#### 3.2. Test Facility

The test facility is recognized, certified, or accredited by the following organizations:

CNAS (No. CNAS L8169)

Shenzhen Global Test Service Co., Ltd. has been assessed and proved to be in compliance with CNAS-CL01 Accreditation Criteria for Testing and Calibration Laboratories (identical to ISO/IEC 17025: 2019 General Requirements) for the Competence of Testing and Calibration Laboratories.

A2LA (Certificate No. 4758.01)

Shenzhen Global Test Service Co., Ltd. has been assessed by the American Association for Laboratory Accreditation (A2LA). Certificate No. 4758.01.

Industry Canada Registration Number. is 24189.

FCC Designation Number is CN1234.

FCC Registered Test Site Number is165725.

#### 3.3. Environmental conditions

During the measurement the environmental conditions were within the listed ranges:

Temperature:	15-35 ° C
Humidity:	30-60 %
Atmospheric pressure:	950-1050mbar

#### 3.4. Statement of the measurement uncertainty

The data and results referenced in this document are true and accurate. The reader is cautioned that there may be errors within the calibration limits of the equipment and facilities. The measurement uncertainty was calculated for all measurements listed in this test report acc. to CISPR 16 - 4 „Specification for radio disturbance and immunity measuring apparatus and methods – Part 4: Uncertainty in EMC Measurements“ and is documented in the Shenzhen Global Test Service Co.,Ltd. quality system acc. to DIN EN ISO/IEC 17025. Furthermore, component and process variability of devices similar to that tested may result in additional deviation. The manufacturer has the sole responsibility of continued compliance of the device.

Hereafter the best measurement capability for Shenzhen GTS laboratory is reported:

Test	Range	Measurement Uncertainty	Notes
Radiated Emission	30~1000MHz	4.10 dB	(1)
Radiated Emission	1~18GHz	4.32 dB	(1)
Radiated Emission	18-40GHz	5.54 dB	(1)
Conducted Disturbance	0.15~30MHz	3.12 dB	(1)

This uncertainty represents an expanded uncertainty expressed at approximately the 95% confidence level using a coverage factor of k=2.



### 3.5. Test Description

Applied Standard: FCC Part 15 Subpart C				
FCC Rules	Description of Test	Test Sample	Result	Remark
§15.207(a)	Conduction Emissions	GTS20220523004-1-1#	N/A	N/A
§15.205(a) §15.209(a) §15.249(a) §15.249(c)	Radiated Emissions Measurement	GTS20220523004-1-1#	Compliant	Note 1
§15.249	Band Edges Measurement	GTS20220523004-1-1#	Compliant	Note 1
§15.249, §15.215	20 dB Bandwidth	GTS20220523004-1-1#	Compliant	Note 1
§15.203	Antenna Requirements	/	Compliant	Note 1

Remark:

1. The measurement uncertainty is not included in the test result.
2. NA = Not Applicable; NP = Not Performed
3. Note 1 – Test results inside test report;
4. Note 2 – Test results in other test report (MPE Report).
5. We tested all test mode and recorded worst case in report

### 3.6. Equipments Used during the Test

Test Equipment	Manufacturer	Model No.	Serial No.	Calibration Date	Calibration Due Date
LISN	CYBERTEK	EM5040A	E1850400105	2021/07/17	2022/07/16
LISN	R&S	ESH2-Z5	893606/008	2021/07/17	2022/07/16
EMI Test Receiver	R&S	ESPI3	101841-cd	2021/07/17	2022/07/16
EMI Test Receiver	R&S	ESCI7	101102	2021/09/19	2022/09/18
Spectrum Analyzer	Agilent	N9020A	MY48010425	2021/09/19	2022/09/18
Spectrum Analyzer	R&S	FSV40	100019	2021/07/17	2022/07/16
Vector Signal generator	Agilent	N5181A	MY49060502	2021/07/17	2022/07/16
Signal generator	Agilent	N5182A	3610AO1069	2021/09/19	2022/09/18
Climate Chamber	ESPEC	EL-10KA	A20120523	2021/09/19	2022/09/18
Controller	EM Electronics	Controller EM 1000	N/A	N/A	N/A
Horn Antenna	Schwarzbeck	BBHA 9120D	01622	2021/11/07	2022/11/06
Active Loop Antenna	Beijing Da Ze Technology Co.,Ltd.	ZN30900C	15006	2021/10/10	2022/11/09
Bilog Antenna	Schwarzbeck	VULB9163	000976	2021/07/23	2022/07/22
Broadband Horn Antenna	SCHWARZBECK	BBHA 9170	791	2021/11/07	2022/11/06
Amplifier	Schwarzbeck	BBV 9743	#202	2021/08/08	2022/08/07
Amplifier	Schwarzbeck	BBV9179	9719-025	2021/07/17	2022/07/16
Amplifier	EMCI	EMC051845B	980355	2021/07/17	2022/07/16
Temperature/Humidity Meter	Gangxing	CTH-608	02	2021/07/17	2022/07/16
High-Pass Filter	K&L	9SH10-2700/X12750-O/O	KL142031	2021/07/17	2022/07/16
High-Pass Filter	K&L	41H10-1375/U12750-O/O	KL142032	2021/07/17	2022/07/16
RF Cable(below 1GHz)	HUBER+SUHNER	RG214	RE01	2021/07/17	2022/07/16
RF Cable(above 1GHz)	HUBER+SUHNER	RG214	RE02	2021/07/17	2022/07/16
Data acquisition card	Agilent	U2531A	TW53323507	2021/07/17	2022/07/16
Power Sensor	Agilent	U2021XA	MY5365004	2021/07/17	2022/07/16
Test Control Unit	Tonscend	JS0806-1	178060067	2021/07/17	2022/07/16
Automated filter bank	Tonscend	JS0806-F	19F8060177	2021/07/17	2022/07/16
EMI Test Software	Tonscend	JS1120-1	Ver 2.6.8.0518	/	/
EMI Test Software	Tonscend	JS1120-3	Ver 2.5.77.0418	/	/
EMI Test Software	Tonscend	JS32-CE	Ver 2.5	/	/
EMI Test Software	Tonscend	JS32-RE	Ver 2.5.1.8	/	/

Note: 1. The Cal.Interval was one year.

## 4. TEST CONDITIONS AND RESULTS

### 4.1. AC Power Conducted Emission

#### TEST CONFIGURATION

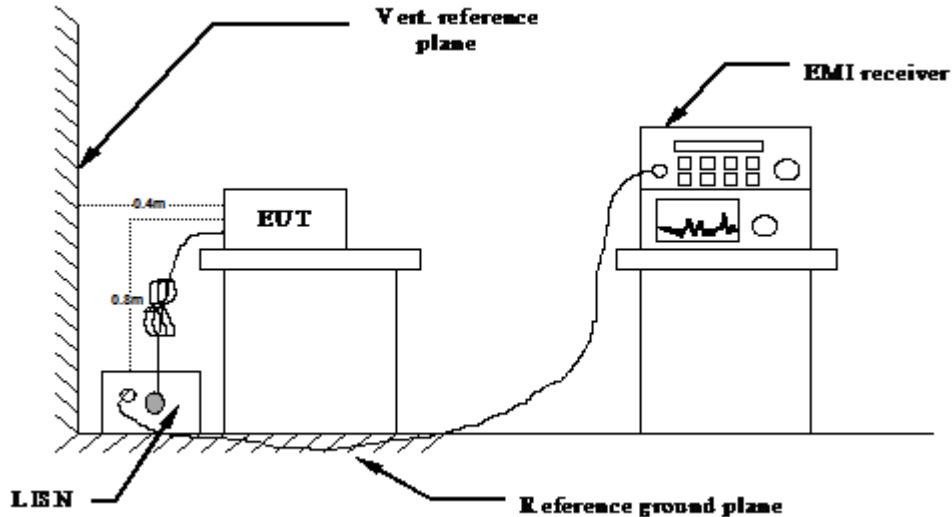

#### TEST PROCEDURE

- 1 The equipment was set up as per the test configuration to simulate typical actual usage per the user's manual. The EUT is a tabletop system, a wooden table with a height of 0.8 meters is used and is placed on the ground plane as per ANSI C63.10-2013.
- 2 Support equipment, if needed, was placed as per ANSI C63.10-2013
- 3 All I/O cables were positioned to simulate typical actual usage as per ANSI C63.10-2013
- 4 All support equipments received AC power from a second LISN, if any.
- 5 The EUT test program was started. Emissions were measured on each current carrying line of the EUT using a spectrum Analyzer / Receiver connected to the LISN powering the EUT. The LISN has two monitoring points: Line 1 (Hot Side) and Line 2 (Neutral Side). Two scans were taken: one with Line 1 connected to Analyzer / Receiver and Line 2 connected to a 50 ohm load; the second scan had Line 1 connected to a 50 ohm load and Line 2 connected to the Analyzer / Receiver.
- 6 Analyzer / Receiver scanned from 150 KHz to 30MHz for emissions in each of the test modes.
- 7 During the above scans, the emissions were maximized by cable manipulation.

#### AC Power Conducted Emission Limit

For intentional device, according to § 15.207(a) AC Power Conducted Emission Limits is as following :

Frequency range (MHz)	Limit (dBuV)	
	Quasi-peak	Average
0.15-0.5	66 to 56*	56 to 46*
0.5-5	56	46
5-30	60	50

\* Decreases with the logarithm of the frequency.

#### TEST RESULTS

Not applicable (AA\*2 battery power).

## 4.2. Radiated Emission

### TEST CONFIGURATION

Frequency range 9 KHz – 30MHz

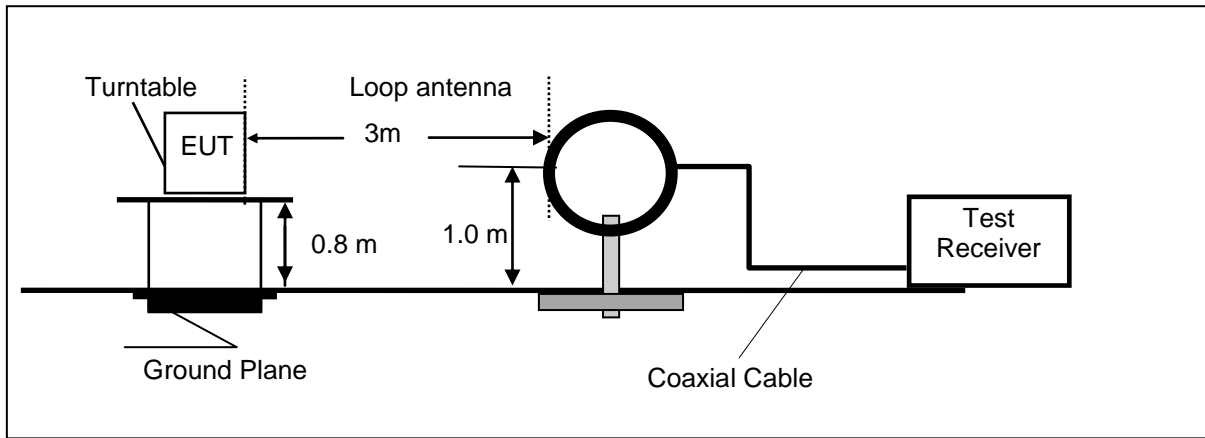

Frequency range 30MHz – 1000MHz

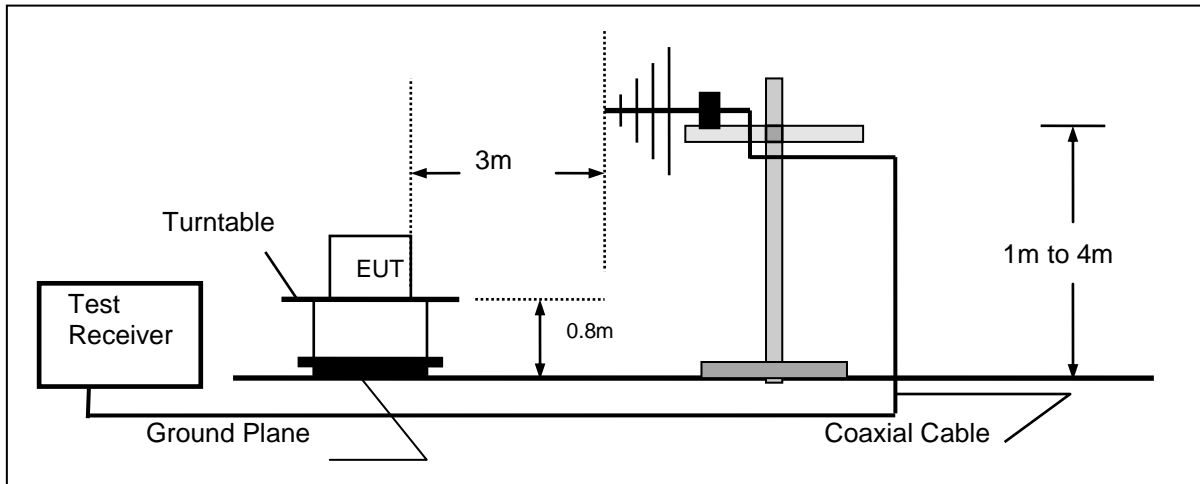

Frequency range above 1GHz-25GHz

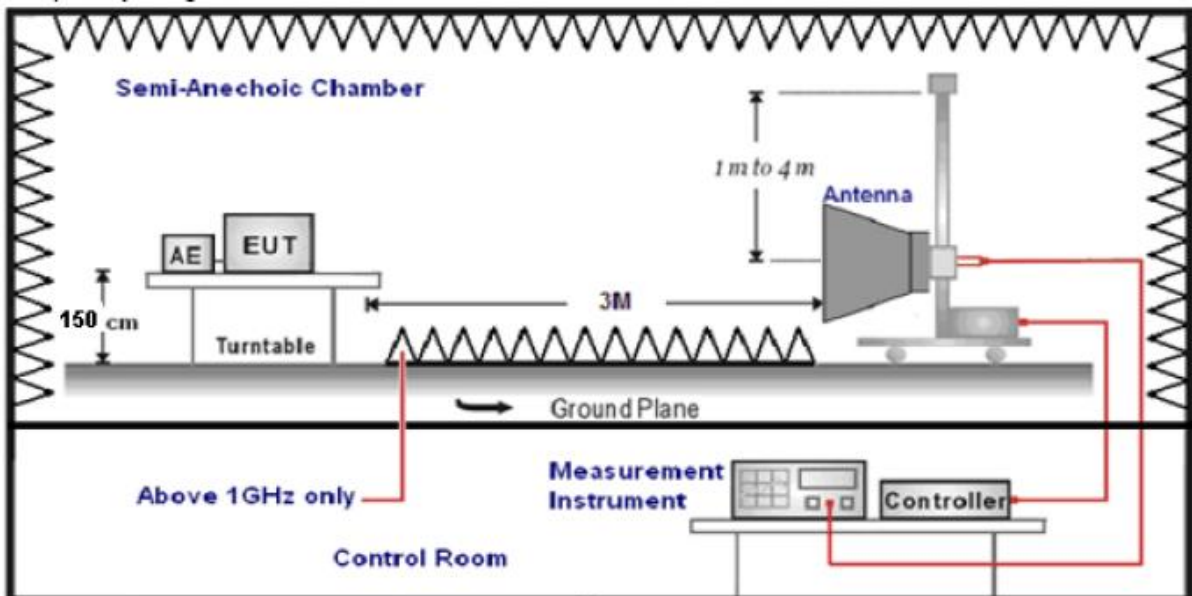

**TEST PROCEDURE**

- The EUT was placed on a turn table which is 0.8m above ground plane when testing frequency range 9 KHz –1GHz;the EUT was placed on a turn table which is 1.5m above ground plane when testing frequency range 1GHz – 25GHz.
- Maximum procedure was performed by raising the receiving antenna from 1m to 4m and rotating the turn table from 0°C to 360°C to acquire the highest emissions from EUT.
- And also, each emission was to be maximized by changing the polarization of receiving antenna both horizontal and vertical.
- Repeat above procedures until all frequency measurements have been completed.
- Radiated emission test frequency band from 30MHz to 25GHz.
- The distance between test antenna and EUT as following table states:

Test Frequency range	Test Antenna Type	Test Distance
9KHz-30MHz	Active Loop Antenna	3
30MHz-1GHz	Ultra-Broadband Antenna	3
1GHz-18GHz	Double Ridged Horn Antenna	3
18GHz-25GHz	Horn Antenna	1

- Setting test receiver/spectrum as following table states:

Test Frequency range	Test Receiver/Spectrum Setting	Detector
9KHz-150KHz	RBW=200Hz/VBW=3KHz, Sweep time=Auto	QP
150KHz-30MHz	RBW=9KHz/VBW=100KHz, Sweep time=Auto	QP
30MHz-1GHz	RBW=120KHz/VBW=1000KHz, Sweep time=Auto	QP
1GHz-40GHz	Peak Value: RBW=1MHz/VBW=3MHz, Sweep time=Auto Average Value: RBW=1MHz/VBW=10Hz, Sweep time=Auto	Peak

**Field Strength Calculation**

The field strength is calculated by adding the Antenna Factor and Cable Factor and subtracting the Amplifier Gain and Duty Cycle Correction Factor(if any) from the measured reading. The basic equation with a sample calculation is as follows:

$$FS = RA + AF + CL - AG$$

Where FS = Field Strength	CL = Cable Attenuation Factor (Cable Loss)
RA = Reading Amplitude	AG = Amplifier Gain
AF = Antenna Factor	

$$\text{Transd} = \text{AF} + \text{CL} - \text{AG}$$

**RADIATION LIMIT**

For intentional device, according to § 15.209(a), the general requirement of field strength of radiated emission from intentional radiators at a distance of 3 meters shall not exceed the following table. According to § 15.247(d), in any 100kHz bandwidth outside the frequency band in which the EUT is operating, the radio frequency power that is produced by the intentional radiator shall be at least 20dB below that in the 100kHz bandwidth within the band that contains the highest level of desired power.

1. The pre-test have done for the EUT in three axes and found the worst emission at position shown in test setup photos.

Frequency (MHz)	Distance (Meters)	Radiated (dBµV/m)	Radiated (µV/m)
0.009-0.49	3	$20\log(2400/F(\text{KHz}))+40\log(300/3)$	2400/F(KHz)
0.49-1.705	3	$20\log(24000/F(\text{KHz}))+40\log(30/3)$	24000/F(KHz)
1.705-30	3	$20\log(30)+40\log(30/3)$	30
30-88	3	40.0	100
88-216	3	43.5	150
216-960	3	46.0	200
Above 960	3	54.0	500

2. According to §15.249 (a) & RSS-210§B.10(a): Except as provided in paragraph (b) of this section, the field strength of emissions from intentional radiators operated within these frequency bands shall comply with the following:

Fundamental frequency	Field strength of fundamental		Field strength of harmonics	
	millivolts/meter	dBuV/m	microvolts/meter	dBuV/m
902-928 MHz	50	94	500	54
2400-2483.5 MHz	50	94	500	54
5725-5875 MHz	50	94	500	54
24.0-24.25 GHz	250	108	2500	68

As shown in §15.35(b), for frequencies above 1000 MHz, the field strength limits in paragraphs (a) and (b) of this section are based on average limits. However, the peak field strength of any emission shall not exceed the maximum permitted average limits specified above by more than 20 dB under any condition of modulation. For point-to-point operation under paragraph (b) of this section, the peak field strength shall not exceed 2500 millivolts/meter at 3 meters along the antenna azimuth

The field strength limits shall be measured using an average detector, except for the fundamental emission in the frequency band 902-928 MHz, which is based on measurements using an International Special Committee on Radio Interference (CISPR) quasi-peak detector.

**TEST RESULTS**

Remark: We measured Radiated Emission at SRD mode from 30 MHz to 10GHz in AC120V and the worst case was recorded.

Temperature	24.1°C	Humidity	53.8%
Test Engineer	Jenny Zeng	Configurations	SRD

**For 9 KHz~30MHz**

Freq. (MHz)	Level (dBuV)	Over Limit (dB)	Over Limit (dBuV)	Remark
-	-	-	-	See Note

Note:

The amplitude of spurious emissions which are attenuated by more than 20 dB below the permissible value has no need to be reported.

Distance extrapolation factor =  $40 \log(\text{specific distance} / \text{test distance})$  (dB);

Limit line = specific limits (dBuV) + distance extrapolation factor.

For 30MHz-1GHz

Horizontal

Test Graph

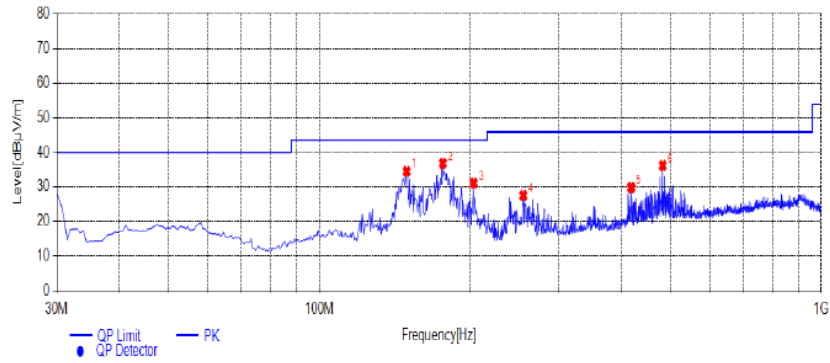

Suspected List

NO.	Frequency [MHz]	Reading [dBµV/m]	Factor [dB]	Result [dBµV/m]	Limit [dBµV/m]	Margin [dB]	Height [cm]	Angle [°]	Detector	Polarity	Remark
1	149.3100	47.27	-12.77	34.50	43.50	9.00	100	72	PK	Horizontal	PASS
2	176.4700	47.71	-10.86	36.85	43.50	6.65	100	2	PK	Horizontal	PASS
3	203.1450	39.81	-8.73	31.08	43.50	12.42	100	325	PK	Horizontal	PASS
4	255.0400	35.27	-7.77	27.50	46.00	18.50	100	45	PK	Horizontal	PASS
5	418.4850	34.15	-4.32	29.83	46.00	16.17	100	88	PK	Horizontal	PASS
6	483.4750	39.49	-3.25	36.24	46.00	9.76	100	13	PK	Horizontal	PASS

Note: 1. Result (dBµV/m) = Reading(dBµV/m) + Factor (dB) .

2. Factor (dB) = Antenna Factor (dB/m) + Cable loss (dB) - Pre Amplifier gain (dB).

Vertical

Test Graph

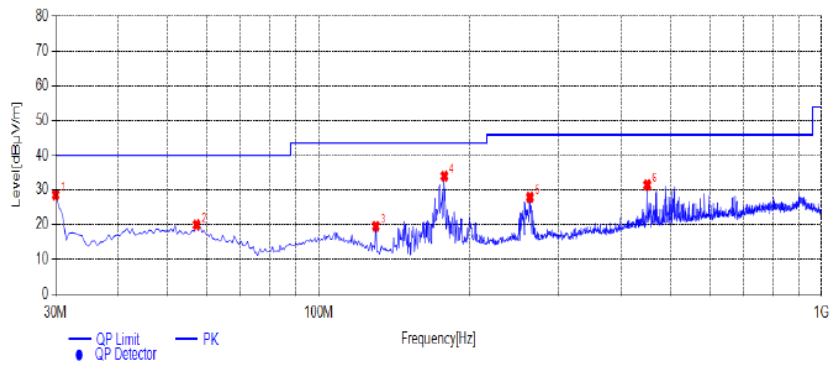

Suspected List

NO.	Frequency [MHz]	Reading [dBµV/m]	Factor [dB]	Result [dBµV/m]	Limit [dBµV/m]	Margin [dB]	Height [cm]	Angle [°]	Detector	Polarity	Remark
1	30.0000	40.08	-11.50	28.58	40.00	11.42	100	342	PK	Vertical	PASS
2	57.1600	27.10	-7.12	19.98	40.00	20.02	100	291	PK	Vertical	PASS
3	129.9100	31.47	-11.88	19.59	43.50	23.91	100	199	PK	Vertical	PASS
4	177.9250	44.97	-10.97	34.00	43.50	9.50	100	335	PK	Vertical	PASS
5	263.2850	35.66	-7.78	27.88	46.00	18.12	100	5	PK	Vertical	PASS
6	450.4950	35.48	-4.06	31.42	46.00	14.58	100	107	PK	Vertical	PASS

Note: 1. Result (dBµV/m) = Reading(dBµV/m) + Factor (dB) .

2. Factor (dB) = Antenna Factor (dB/m) + Cable loss (dB) - Pre Amplifier gain (dB).

## Field strength of fundamental:

Frequency (MHz)	Pol.	Measure Result(PK, dBuV/m)	Measure Result(AV, dBuV/m)	Limit PK (dBuV/m)	Limit AV (dBuV/m)	Margin PK dB	Margin AV dB	Result
2405	H	77.35	72.54	114	94	-36.65	-21.46	Pass
2405	V	76.87	72.89	114	94	-37.13	-21.11	Pass
2440	H	75.39	72.17	114	94	-38.61	-21.83	Pass
2440	V	76.22	71.78	114	94	-37.78	-22.22	Pass
2475	H	75.97	71.85	114	94	-38.03	-22.15	Pass
2475	V	75.82	71.58	114	94	-38.18	-22.42	Pass

## For 1GHz to 25GHz

## Channel 1 / 2407 MHz

Freq. MHz	Reading dBuV	Ant. Fac. dB/m	Pre. Fac. dB	Cab. Loss dB	Measured dBuV/m	Limit dBuV/m	Margin dB	Remark	Pol.
4810.00	49.41	32.44	30.25	7.95	59.55	74.00	-14.45	Peak	Horizontal
4810.00	36.56	32.44	30.25	7.95	46.70	54.00	-7.30	Average	Horizontal
4810.00	52.95	32.44	30.25	7.95	63.09	74.00	-10.91	Peak	Vertical
4810.00	35.44	32.44	30.25	7.95	45.58	54.00	-8.42	Average	Vertical

## Channel 2 / 2442 MHz

Freq. MHz	Reading dBuV	Ant. Fac. dB/m	Pre. Fac. dB	Cab. Loss dB	Measured dBuV/m	Limit dBuV/m	Margin dB	Remark	Pol.
4880.00	49.05	32.52	30.31	8.12	59.38	74.00	-14.62	Peak	Horizontal
4880.00	36.53	32.52	30.31	8.12	46.86	54.00	-7.14	Average	Horizontal
4880.00	51.37	32.52	30.31	8.12	61.70	74.00	-12.30	Peak	Vertical
4880.00	35.26	32.52	30.31	8.12	45.59	54.00	-8.41	Average	Vertical

## Channel 3 / 2477 MHz

Freq. MHz	Reading dBuV	Ant. Fac. dB/m	Pre. Fac. dB	Cab. Loss dB	Measured dBuV/m	Limit dBuV/m	Margin dB	Remark	Pol.
4950.00	50.16	32.68	30.27	7.88	60.45	74.00	-13.55	Peak	Horizontal
4950.00	36.51	32.68	30.27	7.88	46.80	54.00	-7.20	Average	Horizontal
4950.00	50.16	32.68	30.27	7.88	60.45	74.00	-13.55	Peak	Vertical
4950.00	32.34	32.68	30.27	7.88	42.63	54.00	-11.37	Average	Vertical

## Notes:

- 1). Measuring frequencies from 9 KHz~10<sup>th</sup> harmonic or 26.5GHz (which is less), No emission found between lowest internal used/generated frequency to 30MHz.
- 2). Radiated emissions measured in frequency range from 9 KHz~10<sup>th</sup> harmonic or 26.5GHz (which is less) were made with an instrument using Peak detector mode.
- 3). Data of measurement within this frequency range shown " --- " in the table above means the reading of emissions are attenuated more than 20dB below the permissible limits or the field strength is too small to be measured.
- 4). Measured= Reading- Pre. Fac.+ Ant. Fac.+ Cab. Loss
- 5). Margin = Measured- Limit



### 4.3. 20dB Bandwidth

#### TEST CONFIGURATION

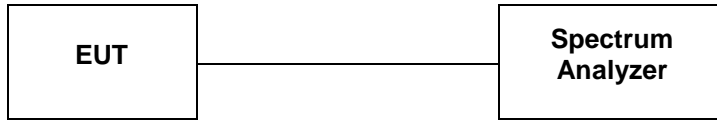

#### TEST PROCEDURE

Use the following spectrum analyzer settings:

Span = approximately 2 to 5 times the 20 dB bandwidth, centered on a hopping channel

RBW = 1% to 5% of the 20 dB bandwidth

VBW = 3 RBW

Sweep = auto

Detector function = peak

Trace = max hold

The EUT should be transmitting at its maximum data rate. Allow the trace to stabilize. Use the marker-to-peak function to set the marker to the peak of the emission. Use the marker-delta function to measure 20 dB down one side of the emission. Reset the marker-delta function, and move the marker to the other side of the emission, until it is (as close as possible to) even with the reference marker level. The marker-delta reading at this point is the 20 dB bandwidth of the emission. If this value varies with different modes of operation (e.g., data rate, modulation format, etc.), repeat this test for each variation. The limit is specified in one of the subparagraphs of this Section. Submit this plot(s).

#### LIMIT

Non-Specified

#### TEST RESULTS

Temperature	24.2°C	Humidity	54.9%
Test Engineer	Jenny Zeng	Configurations	BT

Modulation	Channel	20dB Bandwidth (MHz)	Result
GFSK	1	0.9843	Pass
	2	0.9575	Pass
	3	0.9719	Pass

20dB Bandwidth

CH1

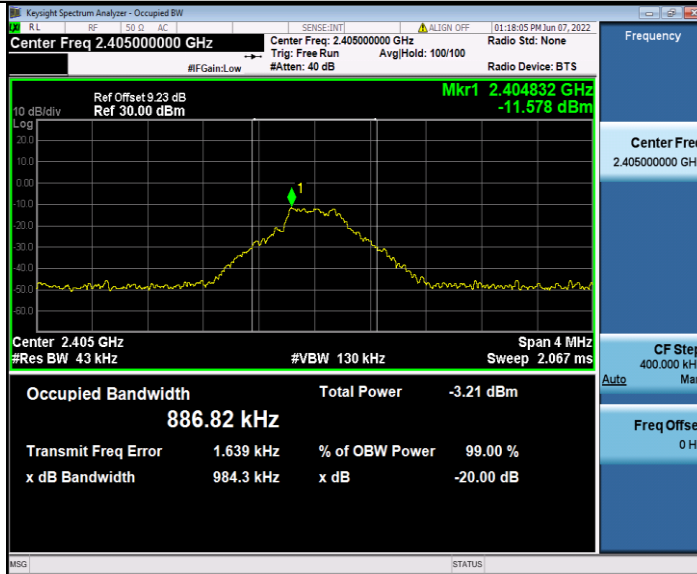

CH2

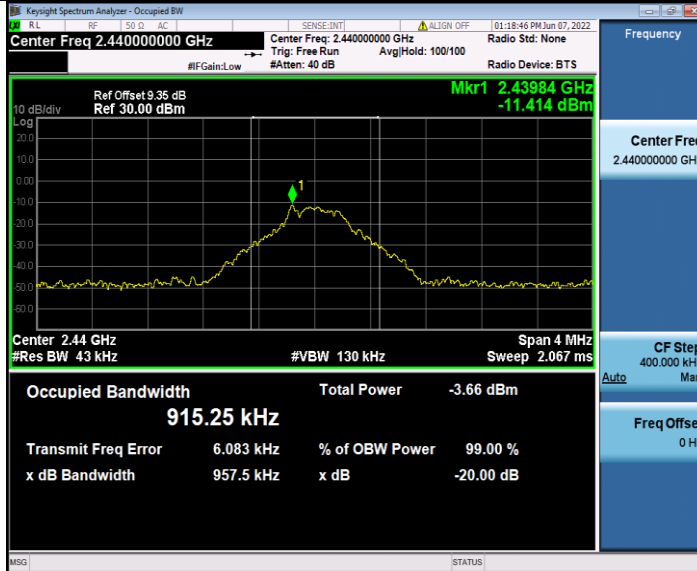

CH3

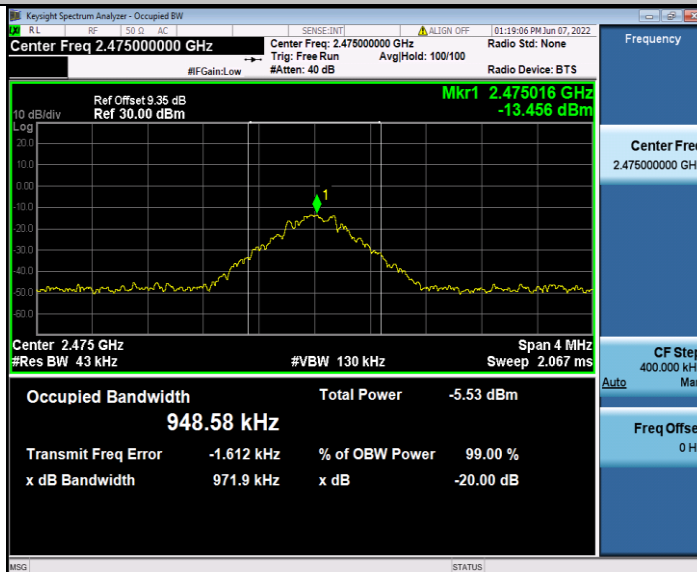

#### 4.4. Band Edge Compliance of RF Emission

##### TEST REQUIREMENT

Emissions radiated outside of the specified frequency bands, except for harmonics, shall be attenuated by at least 50 dB below the level of the fundamental or to the general radiated emission limits in Section 15.209, whichever is the lesser attenuation.

##### TEST CONFIGURATION

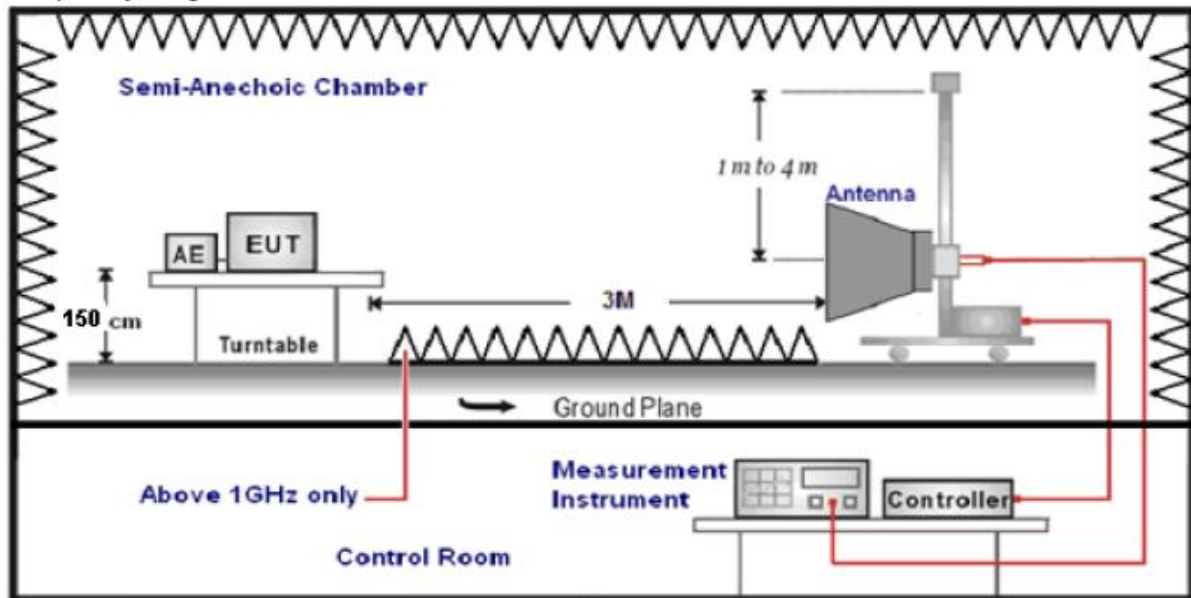

##### TEST PROCEDURE

The EUT is placed on a turntable, which is 0.8m above the ground plane. The turntable shall be rotated for 360 degrees to determine the position of maximum emission level.

EUT is set 3m away from the receiving antenna, which is varied from 1m to 4m to find out the highest emission. Set the spectrum analyzer in the following setting in order to capture the lower and upper band-edges of the emission:

Peak: RBW=120MHz, RBW=300MHz / Sweep=AUTO

Repeat the procedures until the peak versus polarization are measured.

##### LIMIT

Below -20dB of the highest emission level in operating band.

Radiated emissions which fall in the restricted bands, as defined in § 15.205(a), must also comply with the radiated emission limits specified in § 15.209(a)

**TEST RESULTS****4.4.1 For Radiated Bandedge Measurement**

Temperature	23.8°C	Humidity	53.7%
Test Engineer	Jenny Zeng	Configurations	BT

Frequency(MHz):			2402			Polarity:			HORIZONTAL		
Frequency (MHz)	Emission Level (dBuV/m)		Limit (dBuV/m)	Margin (dB)	Antenna Height (m)	Table Angle (Degree)	Raw Value (dBuV)	Antenna Factor (dB/m)	Cable Factor (dB)	Pre-amplifier	Correction Factor (dB/m)
2390.00	47.05	PK	74.00	-26.95	1	82	52.36	27.49	3.32	36.12	-5.31
2390.00	34.75	AV	54.00	-19.25	1	82	40.06	27.49	3.32	36.12	-5.31
Frequency(MHz):			2402			Polarity:			VERTICAL		
Frequency (MHz)	Emission Level (dBuV/m)		Limit (dBuV/m)	Margin (dB)	Antenna Height (m)	Table Angle (Degree)	Raw Value (dBuV)	Antenna Factor (dB/m)	Cable Factor (dB)	Pre-amplifier	Correction Factor (dB/m)
2390.00	50.17	PK	74.00	-23.83	1	285	55.48	27.49	3.32	36.12	-5.31
2390.00	31.50	AV	54.00	-22.50	1	285	36.81	27.49	3.32	36.12	-5.31
Frequency(MHz):			2480			Polarity:			HORIZONTAL		
Frequency (MHz)	Emission Level (dBuV/m)		Limit (dBuV/m)	Margin (dB)	Antenna Height (m)	Table Angle (Degree)	Raw Value (dBuV)	Antenna Factor (dB/m)	Cable Factor (dB)	Pre-amplifier	Correction Factor (dB/m)
2483.50	45.25	PK	74.00	-28.75	1	183	50.97	27.45	3.38	36.55	-5.72
2483.50	33.89	AV	54.00	-20.11	1	183	39.61	27.45	3.38	36.55	-5.72
Frequency(MHz):			2480			Polarity:			VERTICAL		
Frequency (MHz)	Emission Level (dBuV/m)		Limit (dBuV/m)	Margin (dB)	Antenna Height (m)	Table Angle (Degree)	Raw Value (dBuV)	Antenna Factor (dB/m)	Cable Factor (dB)	Pre-amplifier	Correction Factor (dB/m)
2483.50	49.87	PK	74.00	-24.13	1	116	55.59	27.45	3.38	36.55	-5.72
2483.50	31.06	AV	54.00	-22.94	1	116	36.78	27.45	3.38	36.55	-5.72

## REMARKS:

1. Emission level (dBuV/m) =Raw Value (dBuV)+Correction Factor (dB/m)
2. Correction Factor (dB/m) = Antenna Factor (dB/m)+Cable Factor (dB)-Pre-amplifier Factor
3. Margin value = Limit value- Emission level.
4. -- Mean the PK detector measured value is below average limit.
5. The other emission levels were very low against the limit.

4.4.2 For Conducted Bandedge Measurement

Temperature	22.9°C	Humidity	53.2%
Test Engineer	Jenny Zeng	Configurations	BT

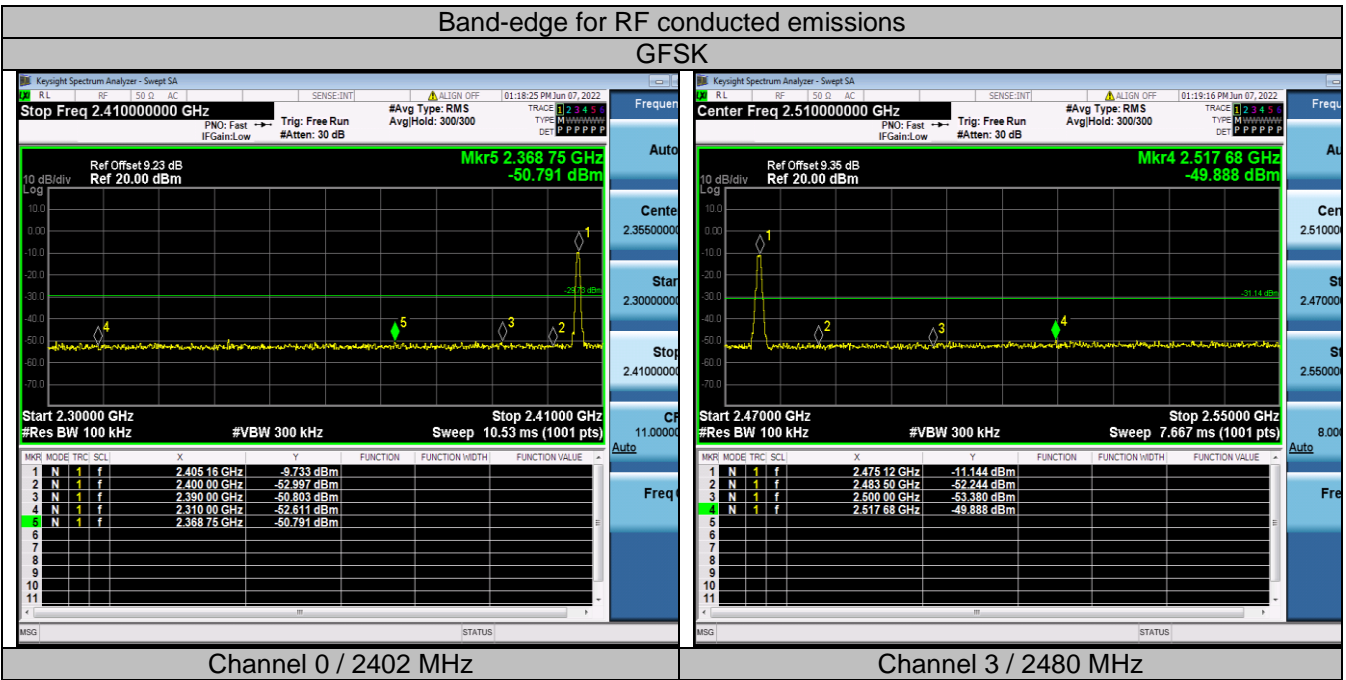

## 4.5. Antenna Requirement

### Standard Applicable

For intentional device, according to FCC 47 CFR Section 15.203, an intentional radiator shall be designed to ensure that no antenna other than that furnished by the responsible party shall be used with the device.

And according to FCC 47 CFR Section 15.247 (c), if transmitting antennas of directional gain greater than 6dBi are used, the power shall be reduced by the amount in dB that the directional gain of the antenna exceeds 6dBi.

### Test Result

The antenna used for this product is Internal Antenna and that no antenna other than that furnished by the responsible party shall be used with the device, the maximum peak gain of the transmit antenna is only 1.50dBi.

Reference to the **Internal photos**.

## 5. TEST SETUP PHOTOS OF THE EUT

Photo of Radiated Emissions Measurement

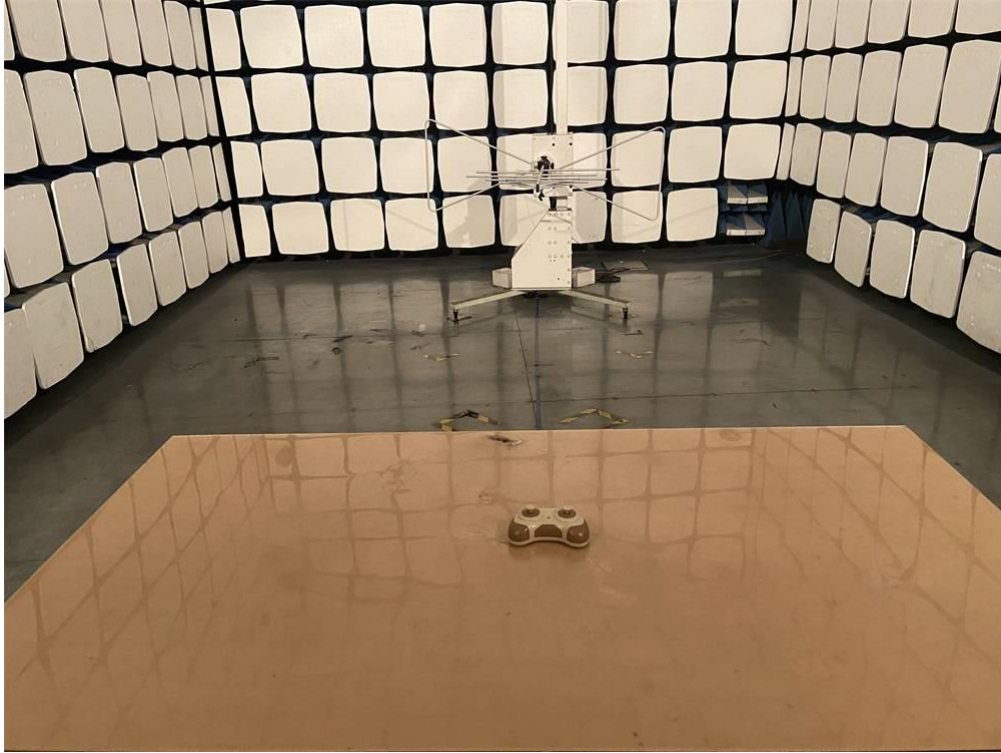

Fig. 1



Fig. 2

## 6. EXTERNAL AND INTERNAL PHOTOS OF THE EUT



Fig. 1



Fig. 2





Fig. 3



Fig. 4



Fig. 5

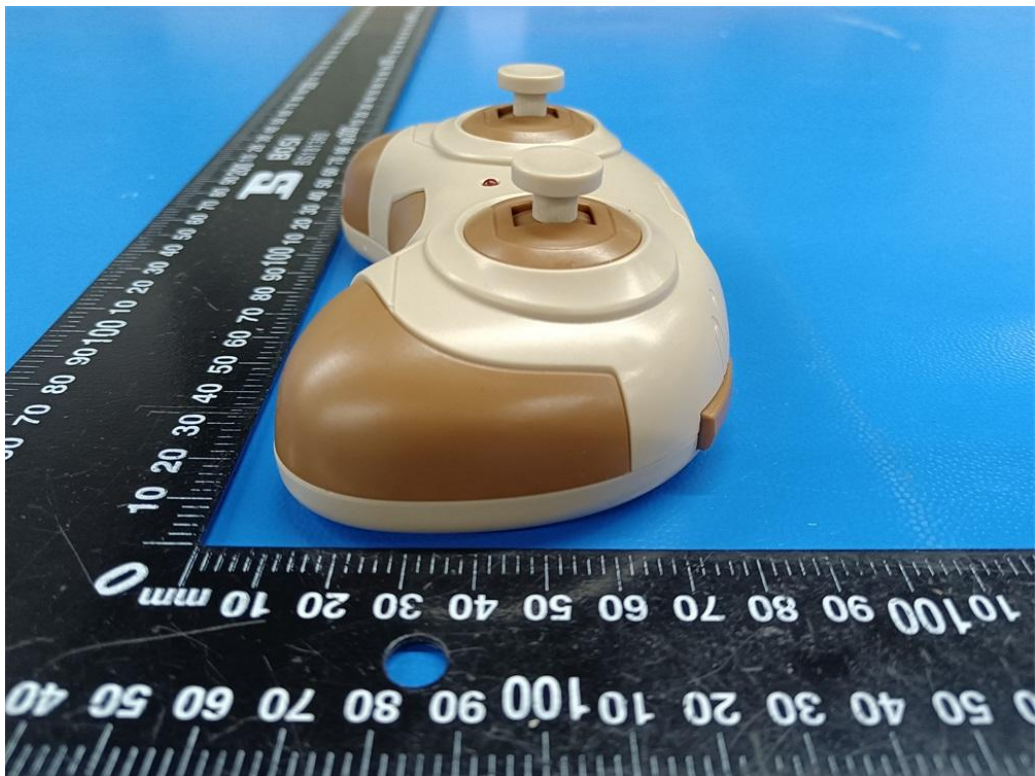

Fig. 6

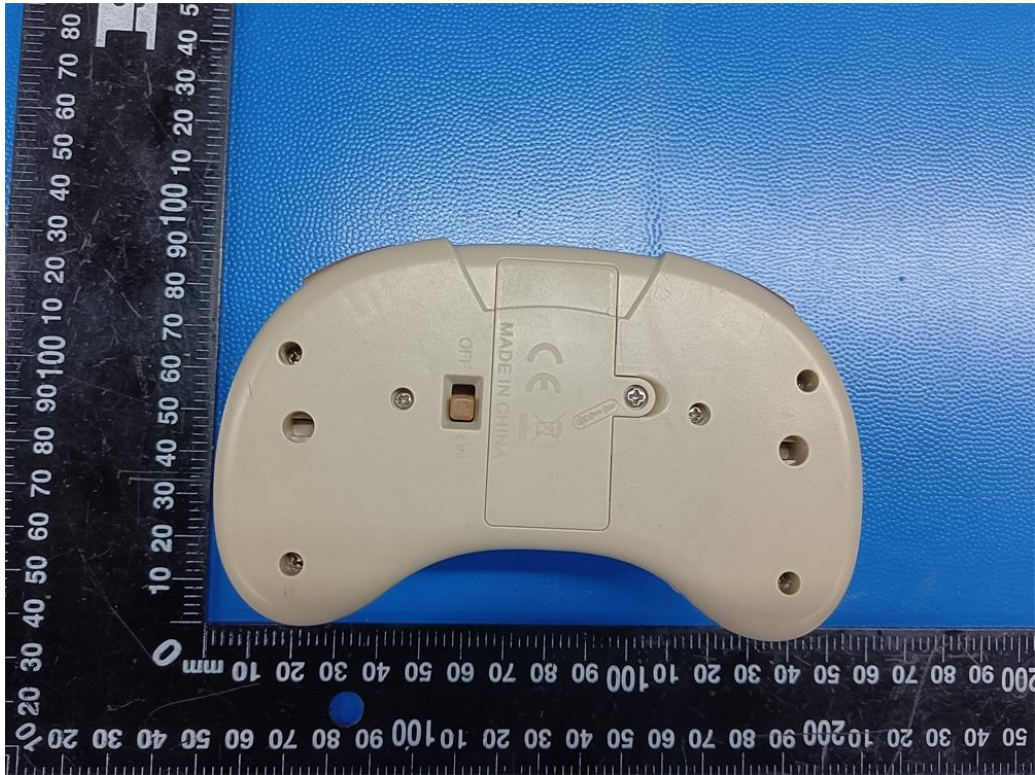

Fig. 7

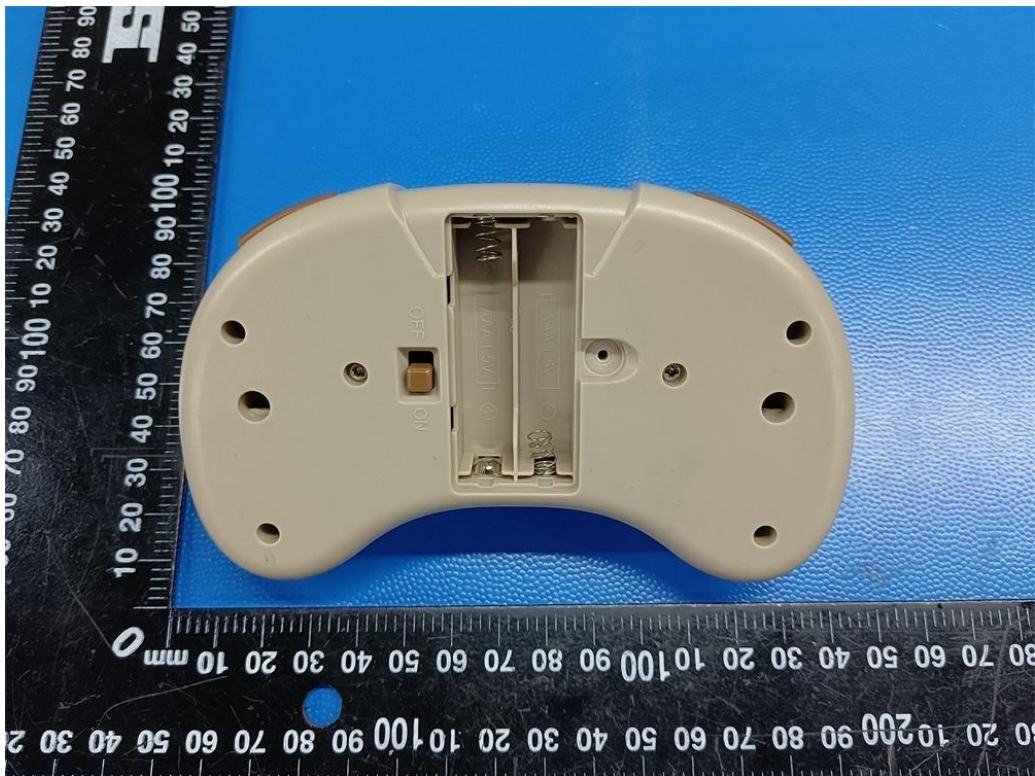

Fig. 8

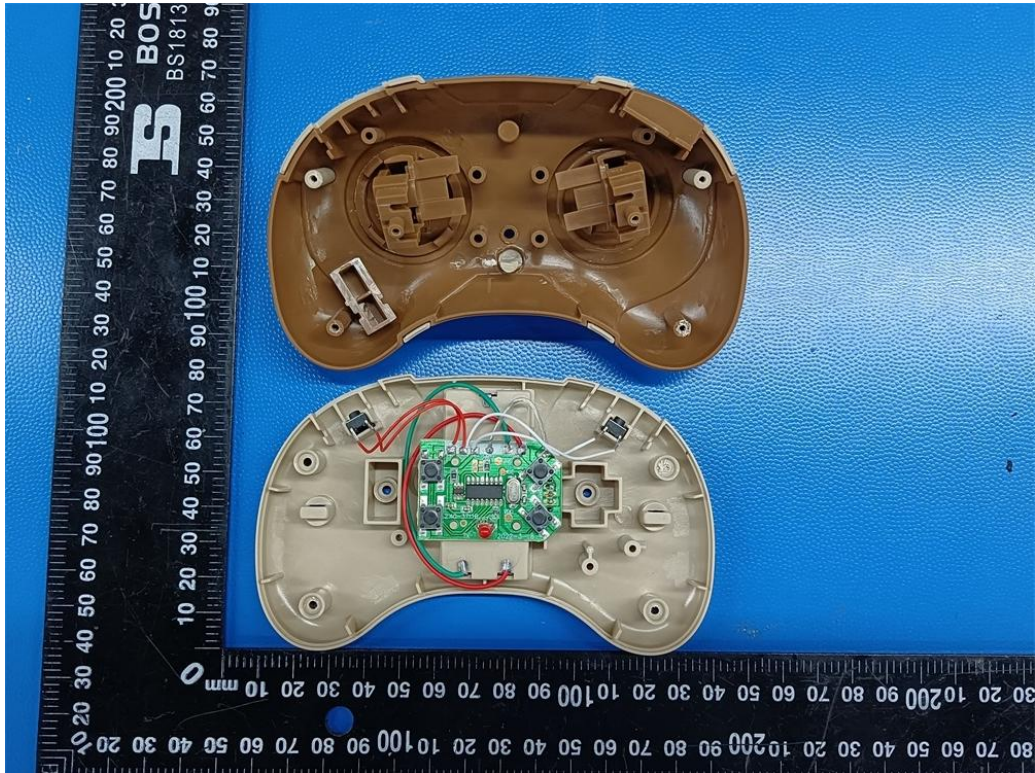

Fig. 9

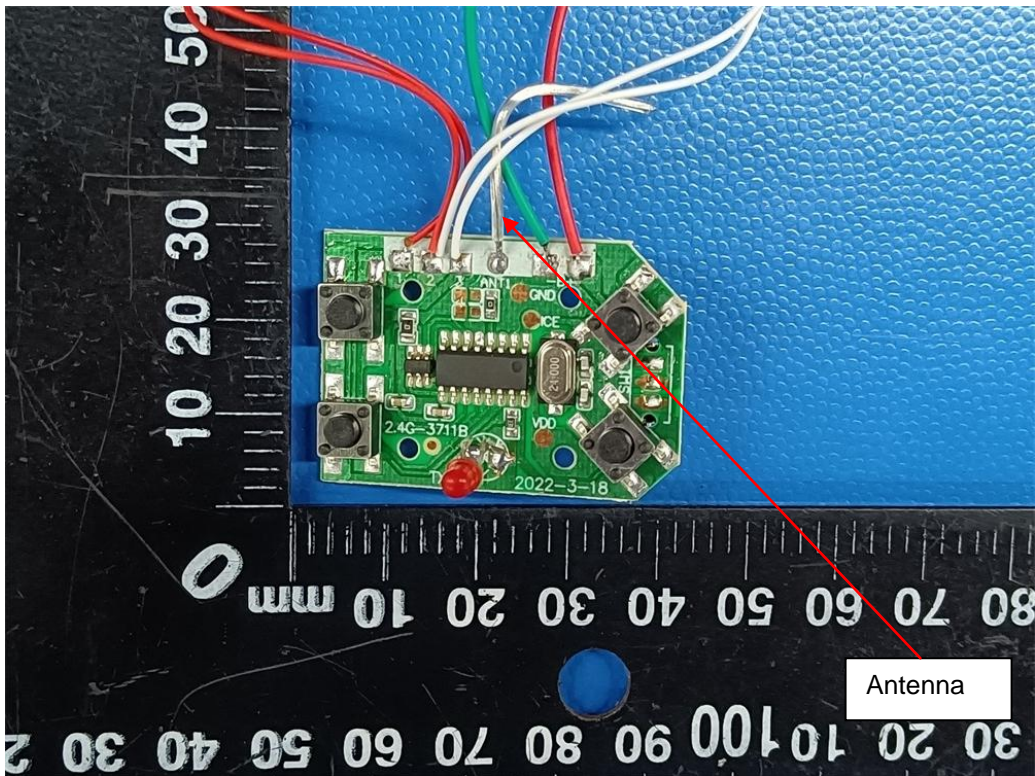

Fig. 10

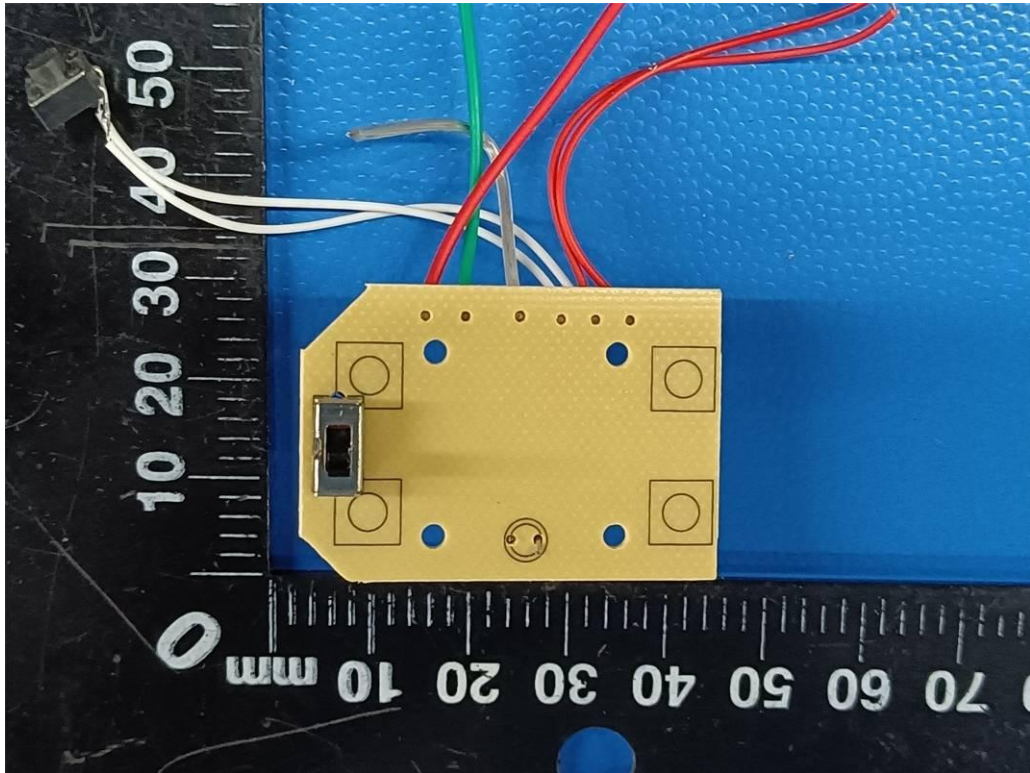

Fig. 11

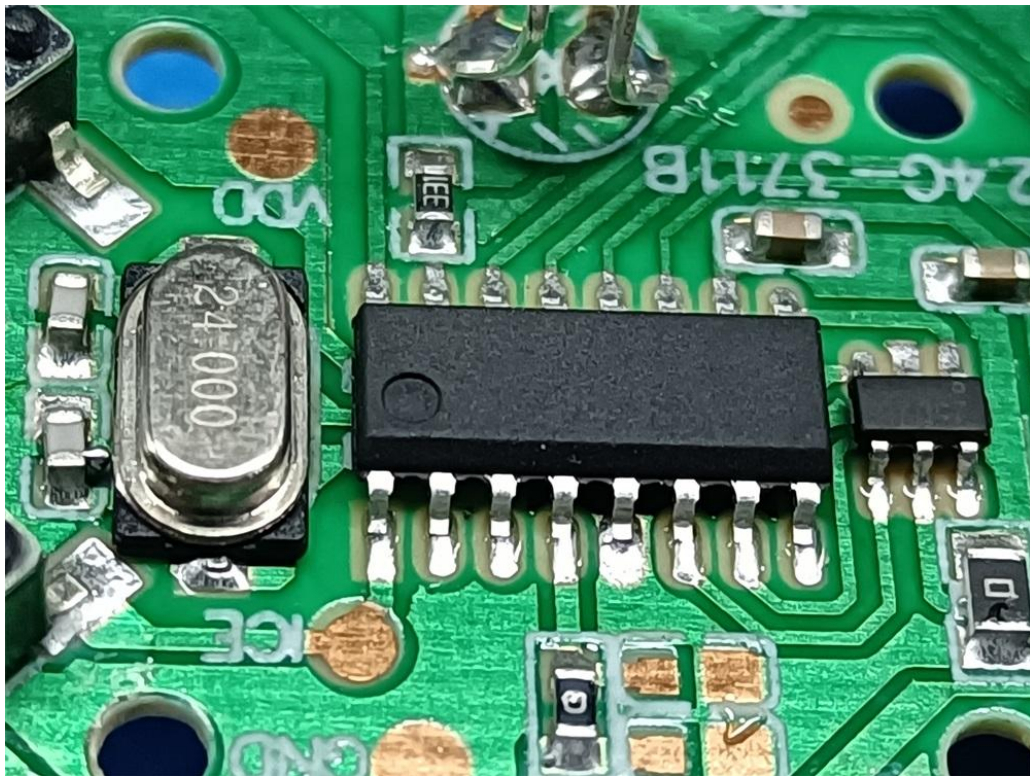

Fig. 12

.....End of Report.....