

TEST REPORT

Report No.: SHATBL2404002W01

Applicant : Guangdong Pine Lake Technology Co., Ltd
Product Name : smart hummingbird feeder
Brand Name : N/A
Model Name : HM01
FCC ID : 2A5LX-HM01
Test Standard : 47 CFR 15.247
Date of Test : 2024.03.14-2024.03.28

Report Prepared by : Chris Xu
(Chris Xu)

Report Approved by : Ghost Li.
(Ghost Li)

Authorized Signatory : Terry Yang
(Terry Yang)



TABLE OF CONTENTS

REVISION HISTORY	3
DECLARATION OF REPORT	4
SUMMARY OF TEST RESULT	5
1. GENERAL DESCRIPTION	6
1.1. Applicant	6
1.2. Manufacturer	6
1.3. Factory	6
1.4. General Information of EUT	7
1.5. Equipment Specification	8
1.6. Modification of EUT	9
1.7. Laboratory Information	9
1.8. Applicable Standards	9
2. TEST CONFIGURATION OF EUT	10
2.1. Carrier Frequency Channel	10
2.2. Test Modes	10
2.3. Block Diagram of Test System	11
2.4. Description of Support Units	11
2.5. Test Software and Power Level	11
2.6. EUT Operating Conditions	11
2.7. Equipment List	12
2.8. Measurement Uncertainty	14
3. TEST RESULT	15
3.1. Maximum Peak Conducted Output Power	15
3.2. Duty Cycle	16
3.3. 6dB Bandwidth and 99% Bandwidth	17
3.4. Power Spectral Density	19
3.5. Conducted Band Edge	20
3.6. Conducted Spurious Emission	21
3.7. Radiated Spurious Emission and Restricted Band	22
3.8. AC Power-Line Conducted Emission	26
3.9. Antenna Requirement	28
4. Test Setup Photographs	29
5. External and Internal Photos of the EUT	29

REVISION HISTORY

Rev.	Issue Date	Revisions	Revised by
A0	2024.03.28	Initial Release	Ghost Li

DECLARATION OF REPORT

1. The device has been tested by ATBL, and the test results show that the equipment under test (EUT) is in compliance with the requirements of 47 CFR 15.247. And it is applicable only to the tested sample identified in the report.

2. This report shall not be reproduced except in full, without the written approval of ATBL, this document only be altered or revised by ATBL, personal only, and shall be noted in the revision of the document.

3. The general information of EUT in this report is provided by the customer or manufacture, ATBL is only responsible for the test data but not for the information provided by the customer or manufacture.

4. The results in this report is only apply to the sample as tested under conditions. The customer or manufacturer is responsible for ensuring that the additional production units of this model have the same electrical and mechanical components.

5. In this report, '' indicates that EUT does not support content after '' , and '' indicates that it supports content after ''

SUMMARY OF TEST RESULT

Report Section	Standard Section	Test Item	Judgment	Remark
3.1	47 CFR 15.247(b)(3)	Maximum Peak Conducted Output Power	PASS	--
3.2	--	Duty Cycle	Report only	--
3.3	47 CFR 15.247(a)(2)	6dB Bandwidth	PASS	--
	--	99% Bandwidth	Report only	--
3.4	47 CFR 15.247(e)	Power Spectral Density	PASS	--
3.5	47 CFR 15.247(d)	Conducted Band Edge	PASS	--
3.6	47 CFR 15.247(d)	Conducted Spurious Emission	PASS	--
3.7	47 CFR 15.247(d)/15.209(a)/15.205(a)	Radiated Spurious Emission and Restricted Band	PASS	--
3.8	47 CFR 15.207(a)	AC Power-Line Conducted Emission	PASS	--
3.9	47 CFR 15.203	Antenna Requirements	PASS	--

Note:

The measurement uncertainty is not included in the test result.

1. GENERAL DESCRIPTION

1.1. Applicant

Name : Guangdong Pine Lake Technology Co., Ltd
Address : 701,Building 1, No. 2, Nanbo Road, Songshan Lake Park523808, Dongguan City,
Guangdong Province, China

1.2. Manufacturer

Name : Guangdong Pine Lake Technology Co., Ltd
Address : 701,Building 1, No. 2, Nanbo Road, Songshan Lake Park523808, Dongguan City,
Guangdong Province, China

1.3. Factory

Name : Guangdong Pine Lake Technology Co., Ltd
Address : 701,Building 1, No. 2, Nanbo Road, Songshan Lake Park523808, Dongguan City,
Guangdong Province, China

1.4. General Information of EUT

General Information	
Equipment Name	smart hummingbird feeder
Brand Name	N/A
Model Name	HM01
Series Model	HM02, HM03
Model Difference	Different shell and model, the circuit structure principle is the same.
Power supply	DC 5V 1A
Battery	Rated Voltage: DC 3.6V Charge Limit Voltage: DC 4.2V Capacity: 5200mAh
Hardware Version	NX-202207-V1.0.4
Software Version	3.6.254
Connecting I/O Port(s)	Refer to the remark below.

Remark:

The above information of EUT was declared by manufacturer. Please refer to the specifications or user's manual for more detailed description.

1.5. Equipment Specification

Equipment Specification				
Frequency Range	2400MHz - 2483.5MHz			
Maximum Output Power To Antenna	<input checked="" type="checkbox"/> 802.11b:	21.73dBm (0.149W)		
	<input checked="" type="checkbox"/> 802.11g:	22.82dBm (0.191W)		
	<input checked="" type="checkbox"/> 802.11n(HT)20:	23.65dBm (0.232W)		
	<input checked="" type="checkbox"/> 802.11n(HT)40:	21.93dBm (0.156W)		
	<input type="checkbox"/> 802.11ac(VHT)20:	dBm (W)		
	<input type="checkbox"/> 802.11ac(VHT)40:	dBm (W)		
	<input type="checkbox"/> 802.11ax(HE)20:	dBm (W)		
	<input type="checkbox"/> 802.11ax(HE)40:	dBm (W)		
Type of Modulation	<input checked="" type="checkbox"/> 802.11b: DSSS (DBPSK/DQPSK/CCK)			
	<input checked="" type="checkbox"/> 802.11g/n(HT): OFDM (BPSK/QPSK/16QAM/64QAM)			
	<input type="checkbox"/> 802.11ac(VHT): OFDM (BPSK/QPSK/16QAM/64QAM/256QAM)			
	<input type="checkbox"/> 802.11ax(HE): OFDM (BPSK/QPSK/16QAM/64QAM/256QAM/1024QAM)			
Antenna Information	<input checked="" type="checkbox"/> SISO	Antenna Type:	FPC	
		Antenna Gain:	3.09dbi	
	<input type="checkbox"/> MIMO	Antenna Number:	/	
		Antenna Type:	/	
		Antenna Gain:	/	
		Antenna Technology:	<input type="checkbox"/> Beamforming <input type="checkbox"/> CDD	
		Directional Gain:	For Power:	
			For PSD:	

1.6. Modification of EUT

No modifications are made to the EUT during all test items.

1.7. Laboratory Information

Company Name	:	Shanghai ATBL Technology Co., Ltd.
Address	:	Building 8, No.160 Basheng Road, Waigaoqiao Free Trade Zone, Pudong New Area, Shanghai
Telephone	:	+86(0)21-51298625

1.8. Applicable Standards

According to the specifications of the manufacturer, the EUT must comply with the requirements of the following standards:

47 CFR Part 15 Subpart C §15.247

FCC KDB 558074 D01 15.247 Meas Guidance v05r02

ANSI C63.10-2013

Remark:

All test items were verified and recorded according to the standards and without any deviation during the test.

2. TEST CONFIGURATION OF EUT

2.1. Carrier Frequency Channel

Frequency Band	Channel	Frequency MHz	Channel	Frequency MHz
2400 - 2483.5 MHz	01	2412	07	2442
	02	2417	08	2447
	03	2422	09	2452
	04	2427	10	2457
	05	2432	11	2462
	06	2437		

Remark:

- For 20 MHz Bandwidth: Low Channel: **CH 01_2412 MHz**; Middle Channel: **CH 06_2437 MHz**; High Channel: **CH 11_2462 MHz**.
- For 40 MHz Bandwidth: Low Channel: **CH 03_2422 MHz**; Middle Channel: **CH 06_2437 MHz**; High Channel: **CH 09_2452 MHz**.

2.2. Test Modes

Final test modes are considering the modulation and worse data rates as below table.

Summary Table of Test Modes			
Test Item	Mode	Data Rate	Channel
For Conducted and Radiated Test	<input checked="" type="checkbox"/> 802.11b:	1 Mbps	Low, Middle, High
	<input checked="" type="checkbox"/> 802.11g:	6 Mbps	Low, Middle, High
	<input checked="" type="checkbox"/> 802.11n(HT)20:	MCS 0	Low, Middle, High
	<input checked="" type="checkbox"/> 802.11n(HT)40:	MCS 0	Low, Middle, High
	<input type="checkbox"/> 802.11ac(VHT)20:	MCS 0	Low, Middle, High
	<input type="checkbox"/> 802.11ac(VHT)40:	MCS 0	Low, Middle, High
	<input type="checkbox"/> 802.11ax(HE)20:	MCS 0	Low, Middle, High
	<input type="checkbox"/> 802.11ax(HE)40:	MCS 0	Low, Middle, High
For AC Power-line Conducted Emission	802.11b mode_Low Channel,802.11b mode_HighChannel		

Remark:

All the test modes of Radiated Spurious Emission (RSE) were tested at the worst data rate; only the worse data shown in report.

2.3. Block Diagram of Test System

2.3.1. For AC Power-Line Conducted Emission

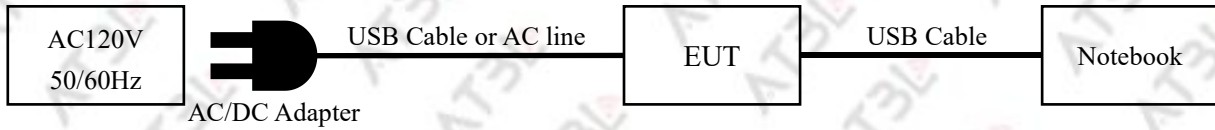

2.3.2. For Radiated Spurious Emission

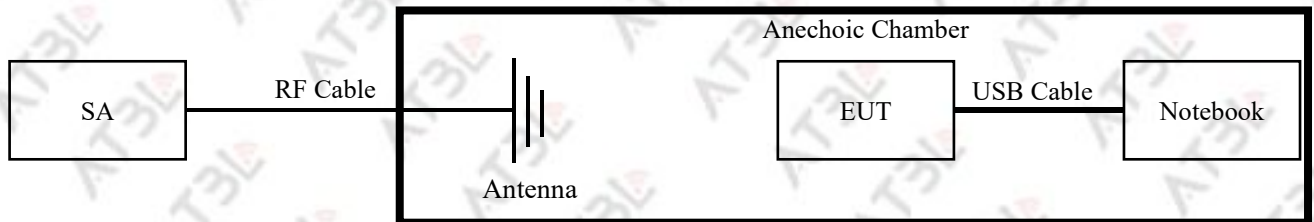

2.3.3. For Conducted Test



2.4. Description of Support Units

NO.	Unit	Brand	Model	Description
1	Adapter	N/A	N/A	for AC Power-Line Conducted Emission
2	DC source	ITECH	IT6720	for Radiated Spurious Emission and Conducted Test
3	PC	Redmi	G36	for fixed frequency

2.5. Test Software and Power Level

During the test, the channel and power control software provided by the customer is used to control the operation channel and output power level.

2.6. EUT Operating Conditions

For AC power-line conducted emission, the EUT was connected under the large package sizes transmission.

For radiated spurious emission and conducted test, the engineering test program was provided and make the EUT to continuous transmit/receive.

2.7. Equipment List

2.7.1. For AC Power-Line Conducted Emission

Equipment Name	Manufacturer	Model	Serial No.	Equipment No.	Calibration Until
Test Receiver	R&S	ESPI	101679	SHATBL-E012	2025.05.21
LISN	R&S	ENV216	100300	SHATBL-E013	2025.05.21
LISN	R&S	ENV216	100333	SHATBL-E041	2025.05.21
Thermometer	DeLi	N/A	N/A	SHATBL-E016	2024.09.20
Test Software	FALA	EZ-EMC	N/A	SHATBL-E046	N/A

2.7.2. For Radiated Spurious Emission

Equipment Name	Manufacturer	Model	Serial No.	Equipment No.	Calibration Until
Signal analyzer	Agilent	N9020A	MY50200811	SHATBL-E017	2025.05.21
Amplifier	JPT	JPA0118-55-303A	1910001800055000	SHATBL-E006	2025.05.21
Amplifier	JPT	JPA-10M1G32	21010100035001	SHATBL-E005	2025.05.21
Antenna/Turn table Controller	Brilliant	N/A	N/A	SHATBL-E007	N/A
Loop Antenna	Daze	ZN30900C	20077	SHATBL-E042	2025.05.21
Bilog Antenna	SCHWARZBECK	VULB 9168	01174	SHATBL-E008	2025.05.21
Broad-band Horn Antenna	SCHWARZBECK	BBHA 9120D	02334	SHATBL-E009	2025.05.21
Horn Antenna	COM-POWER	AH-1840	10100008	SHATBL-E043	2025.05.21
Antenna Tower	BK-4AT-BS	Brilliant	N/A	SHATBL-E065	N/A
Thermometer	DeLi	N/A	N/A	SHATBL-E015	2024.09.20
Test Software	FALA	EMC-RI	N/A	SHATBL-E046	N/A

2.7.3. For Conducted Test

Equipment Name	Manufacturer	Model	Serial No.	Equipment No.	Calibration Until
Power meter	Anritsu	ML2496A	1935001	SHATBL-W030	2024.09.27
Power sensor	Anritsu	MA2411B	1911006	SHATBL-W031	2024.09.27
Power sensor	DARE	RPR3006W	16I00054SN016	SHATBL-W008	2024.09.27
Power sensor	DARE	RPR3006W	RPR6W-2001005	SHATBL-W032	2024.09.27
Power sensor	Rediteq	RPR3006W	RPR6W-2201002	SHATBL-W033	2024.11.15
Power sensor	Rediteq	RPR3006W	RPR6W-2201003	SHATBL-W034	2024.11.15
Power sensor	Keysight	U2021XA	MY59120004	SHATBL-W035	2024.08.14
Adjustable Attenuator	Agilent	8494B	MY42144015	SHATBL-W009	2024.09.27
Adjustable Attenuator	Agilent	8496B	MY42143776	SHATBL-W010	2024.09.27
Environmental Test Chamber	KSON	THS-B6C-150	9159K	SHATBL-W019	2025.01.16
Signal analyzer	Keysight	N9020A	MY50510136	SHATBL-W003	2024.09.27
Switch Box	N/A	RFSW3003328	RFSW201019	SHATBL-W029	N/A
Thermometer	DeLi	N/A	N/A	SHATBL-W012	2024.09.20
Test Software	FALA	LZ-RF	N/A	SHATBL-W020	N/A

2.8. Measurement Uncertainty

The reported uncertainty of measurement $y \pm U$, where expanded uncertainty U is based on a standard uncertainty multiplied by a coverage factor of $k=2$, providing a level of confidence of approximately 95 %.

No.	Item	Uncertainty
1	RF output power, conducted	$\pm 0.958\text{dB}$
2	Conducted spurious emissions	$\pm 2.988\text{dB}$
3	All emissions, radiated 30MHz-1GHz	$\pm 2.50\text{dB}$
4	All emissions, radiated 1GHz-18GHz	$\pm 3.51\text{dB}$
5	Occupied bandwidth	$\pm 23.20\text{Hz}$
6	Power spectral density	$\pm 0.886\text{dB}$

3. TEST RESULT

3.1. Maximum Peak Conducted Output Power

3.1.1. Limit

47 CFR 15.247(b)(3): For systems using digital modulation in the 902-928 MHz, 2400-2483.5 MHz, and 5725-5850 MHz bands: 1 Watt.

47 CFR 15.247(b)(4): If transmitting antennas of directional gain greater than 6 dBi are used, the conducted output power from the intentional radiator shall be reduced below the stated values by the amount in dB that the directional gain of the antenna exceeds 6 dBi.

47 CFR 15.247(c)(1)(i): Systems operating in the 2400–2483.5 MHz band that are used exclusively for fixed, point-to-point operations may employ transmitting antennas with directional gain greater than 6 dBi provided the maximum conducted output power of the intentional radiator is reduced by 1 dB for every 3 dB that the directional gain of the antenna exceeds 6 dBi.

3.1.2. Test Procedure

ANSI C63.10-2013 clause 11.9.1.3 PKPM1 Peak power meter method: The maximum peak conducted output power may be measured using a broadband peak RF power meter. The power meter shall have a video bandwidth that is greater than or equal to the DTS bandwidth and shall use a fast-responding diode detector.

3.1.3. Test Setup

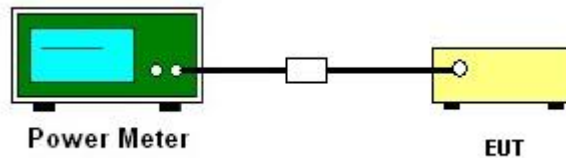

3.1.4. Test Result of Maximum Peak Conducted Output Power

Please refer to the Appendix A.

3.2. Duty Cycle

3.2.1. Limit

There is no limit requirement for Duty Cycle.

3.2.2. Test Procedure

ANSI C63.10-2013 clause 11.6: Measurements of duty cycle and transmission duration shall be performed using one of the following techniques:

1. A diode detector and an oscilloscope that together have a sufficiently short response time to permit accurate measurements of the ON and OFF times of the transmitted signal.

2. The zero-span mode on a spectrum analyzer or EMI receiver if the response time and spacing between bins on the sweep are sufficient to permit accurate measurements of the ON and OFF times of the transmitted signal:

- ① Set the center frequency of the instrument to the center frequency of the transmission.
- ② Set $RBW \geq OBW$ if possible; otherwise, set RBW to the largest available value.
- ③ Set $VBW \geq RBW$. Set detector = peak or average.
- ④ The zero-span measurement method shall not be used unless both RBW and VBW are $> 50/T$ and the number of sweep points across duration T exceeds 100. (For example, if VBW and/or RBW are limited to 3 MHz, then the zero-span method of measuring the duty cycle shall not be used if $T \leq 16.7 \mu s$.)

3.2.3. Test Setup

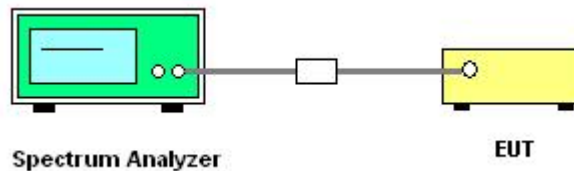

3.2.4. Test Result of Duty Cycle

Please refer to the Appendix A.

3.3. 6dB Bandwidth and 99% Bandwidth

3.3.1. Limit

47 CFR 15.247(a)(2): Systems using digital modulation techniques may operate in the 902-928 MHz, 2400-2483.5 MHz, and 5725-5850 MHz bands. The minimum 6 dB bandwidth shall be at least 500 kHz.

There is no limit requirement for 99% Bandwidth.

3.3.2. Test Procedure

1. The testing of 6dB Bandwidth follows ANSI C63.10-2013 clause 11.8.1: The steps for the first option are as follows:

- ① Set RBW = 100 kHz.
- ② Set the VBW $\geq [3 \times \text{RBW}]$.
- ③ Detector = peak.
- ④ Trace mode = max hold.
- ⑤ Sweep = auto couple.
- ⑥ Allow the trace to stabilize.
- ⑦ Measure the maximum width of the emission that is constrained by the frequencies associated with the two outermost amplitude points (upper and lower frequencies) that are attenuated by 6 dB relative to the maximum level measured in the fundamental emission.

2. The testing of 99% Bandwidth follows ANSI C63.10-2013 clause 6.9.3: The occupied bandwidth is the frequency bandwidth such that, below its lower and above its upper frequency limits, the mean powers are each equal to 0.5% of the total mean power of the given emission. The following procedure shall be used for measuring 99% power bandwidth:

- ① The instrument center frequency is set to the nominal EUT channel center frequency. The frequency span for the spectrum analyzer shall be between 1.5 times and 5.0 times the OBW.
- ② The nominal IF filter bandwidth (3 dB RBW) shall be in the range of 1% to 5% of the OBW, and VBW shall be approximately three times the RBW, unless otherwise specified by the applicable requirement.
- ③ Set the reference level of the instrument as required, keeping the signal from exceeding the maximum input mixer level for linear operation. In general, the peak of the spectral envelope shall be more than $[10 \log (\text{OBW}/\text{RBW})]$ below the reference level. Specific guidance is given in ANSI C63.10-2013 clause 4.1.5.2.
- ④ Step a) through step c) might require iteration to adjust within the specified range.
- ⑤ Video averaging is not permitted. Where practical, a sample detection and single sweep mode shall be used. Otherwise, peak detection and max hold mode (until the trace stabilizes) shall be used.
- ⑥ Use the 99% power bandwidth function of the instrument (if available) and report the measured bandwidth.
- ⑦ If the instrument does not have a 99% power bandwidth function, then the trace data points are recovered and directly summed in linear power terms. The recovered amplitude data points, beginning at

the lowest frequency, are placed in a running sum until 0.5% of the total is reached; that frequency is recorded as the lower frequency. The process is repeated until 99.5% of the total is reached; that frequency is recorded as the upper frequency. The 99% power bandwidth is the difference between these two frequencies.

⑧ The occupied bandwidth shall be reported by providing plot(s) of the measuring instrument display; the plot axes and the scale units per division shall be clearly labeled. Tabular data may be reported in addition to the plot(s).

3.3.3. Test Setup

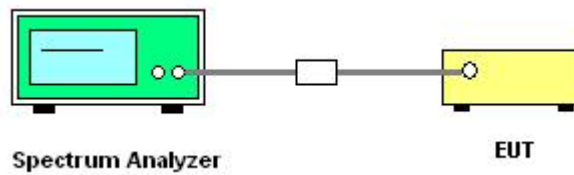

3.3.4. Test Result of 6dB Bandwidth and 99% Bandwidth

Please refer to the Appendix A.

3.4. Power Spectral Density

3.4.1. Limit

47 CFR 15.247(e): For digitally modulated systems, the power spectral density conducted from the intentional radiator to the antenna shall not be greater than 8 dBm in any 3 kHz band during any time interval of continuous transmission.

3.4.2. Test Procedure

ANSI C63.10-2013 clause 11.10.2: The following procedure shall be used if maximum peak conducted output power was used to determine compliance, and it is optional if the maximum conducted (average) output power was used to determine compliance:

1. Set analyzer center frequency to DTS channel center frequency.
2. Set the span to 1.5 times the DTS bandwidth.
3. Set the RBW to 3 kHz.
4. Set the VBW $\geq [3 \times \text{RBW}]$.
5. Detector = peak.
6. Sweep time = auto couple.
7. Trace mode = max hold.
8. Allow trace to fully stabilize.
9. Use the peak marker function to determine the maximum amplitude level within the RBW.

3.4.3. Test Setup

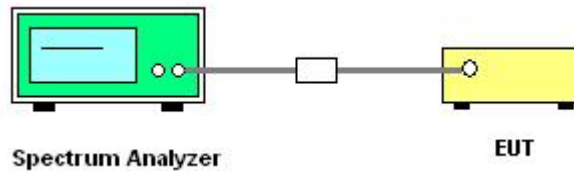

3.4.4. Test Result of Power Spectral Density

Please refer to the Appendix A.

3.5. Conducted Band Edge

3.5.1. Limit

47 CFR 15.247(d): In any 100 kHz bandwidth outside the frequency band in which the spread spectrum or digitally modulated intentional radiator is operating, the radio frequency power that is produced by the intentional radiator shall be at least 20 dB below that in the 100 kHz bandwidth within the band that contains the highest level of the desired power, based on either an RF conducted or a radiated measurement, provided the transmitter demonstrates compliance with the peak conducted power limits.

3.5.2. Test Procedure

1. The testing follows ANSI C63.10-2013 clause 11.13.
2. Set to the maximum power setting and enable the EUT transmit continuously.
3. Set RBW = 100 kHz, VBW=300 kHz, Peak Detector. Conducted Band Edge measured in any 100 kHz bandwidth outside of the authorized frequency band shall be attenuated by at least 20 dB relative to the 100 kHz bandwidth within the band that contains the highest level of the desired power when maximum peak conducted output power procedure is used. If the transmitter complies with the conducted power limits based on the use of RMS averaging over a time interval, the attenuation required under this paragraph shall be 30 dB instead of 20 dB.
4. Measure and record the results in the test report.
5. The RF fundamental frequency should be excluded against the limit line in the operating frequency band.

3.5.3. Test Setup

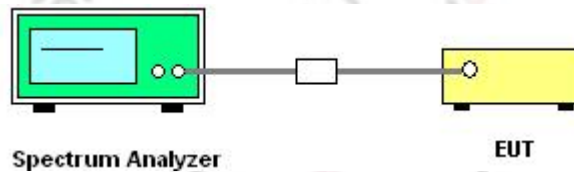

3.5.4. Test Result of Conducted Band Edge

Please refer to the Appendix A.

3.6. Conducted Spurious Emission

3.6.1. Limit

47 CFR 15.247(d): In any 100 kHz bandwidth outside the frequency band in which the spread spectrum or digitally modulated intentional radiator is operating, the radio frequency power that is produced by the intentional radiator shall be at least 20 dB below that in the 100 kHz bandwidth within the band that contains the highest level of the desired power, based on either an RF conducted or a radiated measurement, provided the transmitter demonstrates compliance with the peak conducted power limits.

3.6.2. Test Procedure

1. The testing follows ANSI C63.10-2013 clause 7.8.8.
2. The RF output of EUT was connected to the spectrum analyzer by RF cable and attenuator. The path loss was compensated to the results for each measurement.
3. Set to the maximum power setting and enable the EUT transmit continuously.
4. Set RBW = 100 kHz, VBW = 300kHz, scan up through 10th harmonic. All harmonics / spurs must be at least 20 dB down from the highest emission level within the authorized band as measured with a 100 kHz RBW.
5. Measure and record the results in the test report.
6. The RF fundamental frequency should be excluded against the limit line in the operating frequency band.

3.6.3. Test Setup

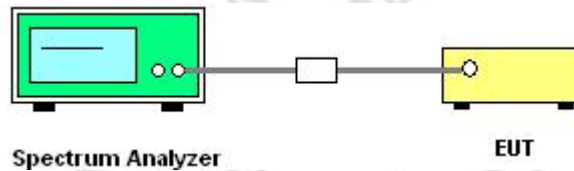

3.6.4. Test Result of Conducted Spurious Emission

Note:

Not recorded emission from 9 KHz to 30 MHz as emission level at least 20dBc lower than emission limit

Please refer to the Appendix A.

3.7. Radiated Spurious Emission and Restricted Band

3.7.1. Limit

47 CFR 15.247(d): In any 100 kHz bandwidth outside the frequency band in which the spread spectrum or digitally modulated intentional radiator is operating, the radio frequency power that is produced by the intentional radiator shall be at least 20 dB below that in the 100 kHz bandwidth within the band that contains the highest level of the desired power, based on either an RF conducted or a radiated measurement, provided the transmitter demonstrates compliance with the peak conducted power limits.

47 CFR 15.205(a): Only spurious emissions are permitted in any of the frequency bands listed below:

Frequency (MHz)	Frequency (MHz)	Frequency (MHz)	Frequency (MHz)	Frequency (MHz)
0.090-0.110	12.29-12.293	149.9-150.05	1660-1710	8.025-8.5
0.495-0.505	12.51975-12.52025	156.52475-156.52525	1718.8-1722.2	9.0-9.2
2.1735-2.1905	12.57675-12.57725	156.7-156.9	2200-2300	9.3-9.5
4.125-4.128	13.36-13.41	162.0125-167.17	2310-2390	10.6-12.7
4.17725-4.17775	16.42-16.423	167.72-173.2	2483.5-2500	13.25-13.4
4.20725-4.20775	16.69475-16.69525	240-285	2690-2900	14.47-14.5
6.215-6.218	16.80425-16.80475	322-335.4	3260-3267	15.35-16.2
6.26775-6.26825	25.5-25.67	399.9-410	3332-3339	17.7-21.4
6.31175-6.31225	37.5-38.25	608-614	3345.8-3358	22.01-23.12
8.291-8.294	73-74.6	960-1240	3600-4400	23.6-24.0
8.362-8.366	74.8-75.2	1300-1427	4500-5150	31.2-31.8
8.37625-8.38675	108-121.94	1435-1626.5	5350-5460	36.43-36.5
8.41425-8.41475	123-138	1645.5-1646.5	7250-7750	Above 38.6

47 CFR 15.209(a): The emissions from an intentional radiator shall not exceed the field strength levels specified in the following table:

Frequency (MHz)	Field strength (microvolts/meter)	Measurement distance (meters)
0.009-0.490	2400/F(kHz)	300
0.490-1.705	24000/F(kHz)	30
1.705-30.0	30	30
30-88	100	3
88-216	150	3
216-960	200	3
Above 960	500	3

3.7.2. Test Procedure

1. The testing follows ANSI C63.10-2013 clause 11.11 & 11.12.
2. The EUT was arranged to its worst case and then tune the antenna tower (from 1 m to 4 m) and turntable (from 0 degree to 360 degrees) to find the maximum reading. A pre-amp and a high pass filter are used for the test in order to get better signal level.
3. The EUT was placed on a turntable with 0.8 meter for frequency below 1GHz and 1.5 meter for frequency above 1GHz respectively above ground.
4. The EUT was set 3 meters from the interference receiving antenna, which was mounted on the top of a variable height antenna tower.
5. Corrected Reading: Antenna Factor + Cable Loss + Read Level - Pre-amp Factor = Level.
6. For testing below 1GHz, if the emission level of the EUT in peak mode was 3 dB lower than the limit specified, then peak values of EUT will be reported, otherwise, the emissions will be repeated one by one using the CISPR quasi-peak method and reported.
7. For testing above 1GHz, the emission level of the EUT in peak mode was 20dB lower than peak limit (that means the emission level in average mode also complies with the limit in average mode), then peak values of EUT will be reported, otherwise, the emissions will be measured in average mode again and reported.
8. Use the following spectrum analyzer settings:
 - ① Span shall wide enough to fully capture the emission being measured;
 - ② When frequency < 1 GHz:
 - Set RBW=100 kHz; VBW \geq RBW; Sweep = auto; Detector function = peak; Trace = max hold;
 - ③ When frequency \geq 1 GHz:
 - Set RBW = 1 MHz; VBW = 3 MHz for peak measurement;
 - Set RBW = 1 MHz; VBW = 10 Hz, when duty cycle is no less than 98 percent or VBW \geq 1/T, when duty cycle is less than 98 percent where T is the minimum transmission duration over which the transmitter is on and is transmitting at its maximum power control level for the tested mode of operation.

3.7.3. Test Setup

3.7.3.1. For radiated emissions below 30MHz

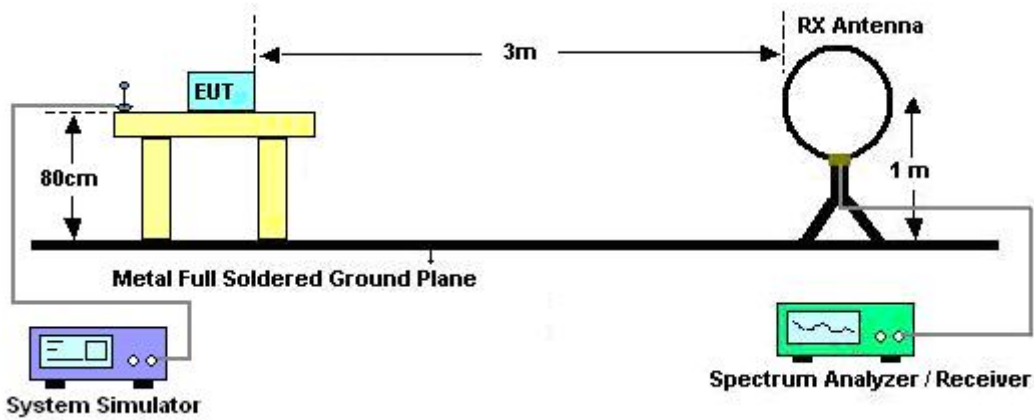

3.7.3.2. For radiated emissions from 30MHz to 1GHz

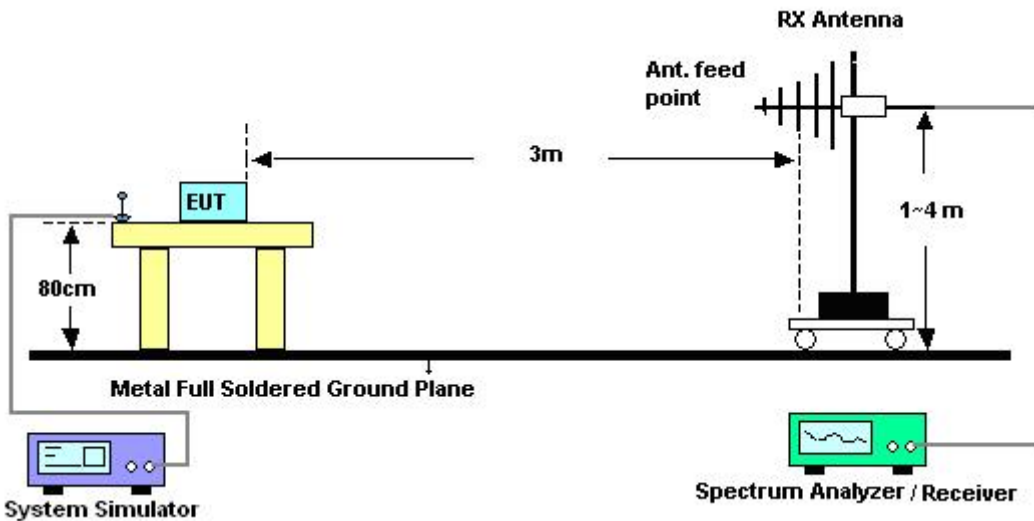

3.7.3.3. For radiated emissions above 1GHz

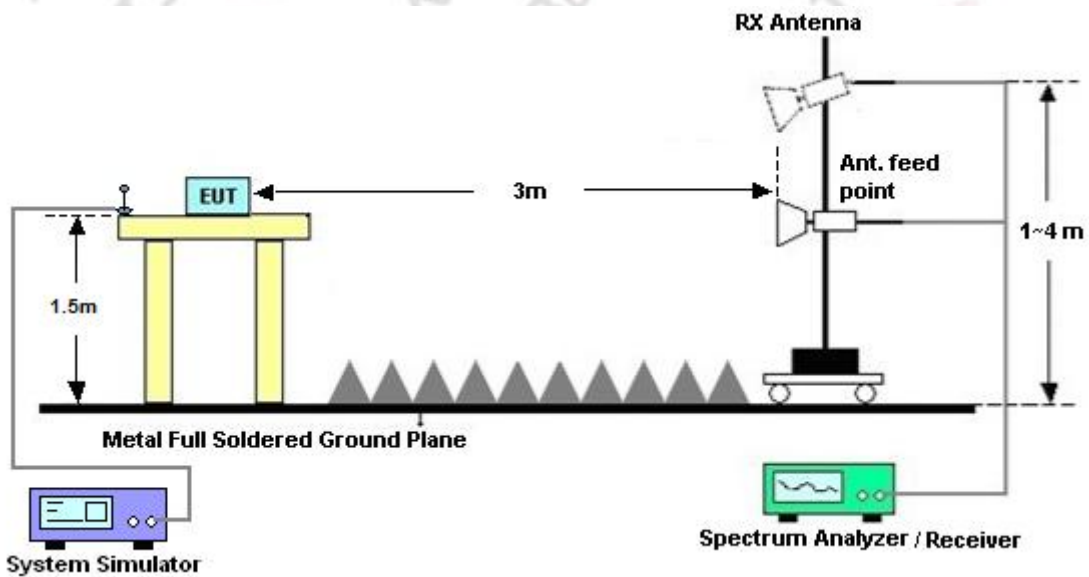

3.7.4. Test Result of Radiated Spurious Emission

Note:

Not recorded emission from 9 KHz to 30 MHz as emission level at least 20dBc lower than emission limit.

Please refer to the Appendix B.

3.7.5. Test Result of Restricted Band

Please refer to the Appendix B.

3.8. AC Power-Line Conducted Emission

3.8.1. Limit

47 CFR 15.207(a): For an intentional radiator that is designed to be connected to the public utility (AC) power line, the radio frequency voltage that is conducted back onto the AC power line on any frequency or frequencies, within the band 150 kHz to 30 MHz, shall not exceed the limits in the following table:

Frequency of emission (MHz)	Conducted limit (dB μ V)	
	Quasi-peak	Average
0.15-0.5	66 to 56*	56 to 46*
0.5-5	56	46
5-30	60	50

*Decreases with the logarithm of the frequency.

3.8.2. Test Procedure

1. The EUT was placed 0.4 meter from the conducting wall of the shielding room was kept at least 80 centimeters from any other grounded conducting surface.
2. Connect EUT to the power mains through a line impedance stabilization network (LISN).
3. All the support units are connecting to the other LISN.
4. The LISN provides 50 ohm coupling impedance for the measuring instrument.
5. The FCC states that a 50 ohm, 50 microhenry LISN should be used.
6. Both sides of AC line were checked for maximum conducted interference.
7. The frequency range from 150 kHz to 30 MHz was searched.
8. Set the test-receiver system to Peak Detect Function and specified bandwidth (IF Bandwidth = 9 kHz) with Maximum Hold Mode. Then measurement is also conducted by Average Detector and Quasi-Peak Detector Function respectively.

3.8.3. Test Setup

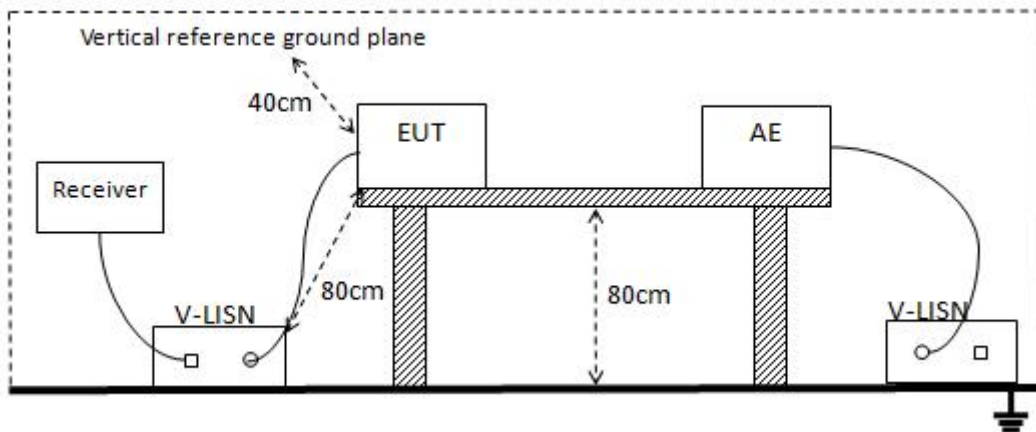

3.8.4. Test Result of AC Power-Line Conducted Emission

Please refer to the Appendix B.

3.9. Antenna Requirement

3.9.1. Standard Requirement

According to 47 CFR 15.203, an intentional radiator shall be designed to ensure that no antenna other than that furnished by the responsible party shall be used with the device.

3.9.2. EUT Antenna

The antenna used for the EUT is fpc antenna, which meets the antenna requirements.

