



FCC DFS Test Report

FCC ID: 2A5LO-TOZEDZLTX100

This report concerns: Original Grant

Project No. : 2312C154
Equipment : 5G Wireless Router
Brand Name : Tozed Kangwei
Test Model : ZLT X100 PRO
Series Model : N/A
Applicant : Tozed Kangwei Tech Co., Ltd
Address : Room 1301, NO. 37 Jinlong , Nansha Street, Xiangjiang Financial Business Center, Nansha District, Guangzhou
Manufacturer : Tozed Kangwei Tech Co., Ltd
Address : Room 1301, NO. 37 Jinlong , Nansha Street, Xiangjiang Financial Business Center, Nansha District, Guangzhou
Factory : Tozed Kangwei Tech Co., Ltd
Address : Room 1301, NO. 37 Jinlong , Nansha Street, Xiangjiang Financial Business Center, Nansha District, Guangzhou
Date of Receipt : Dec. 25, 2023
Date of Test : Dec. 26, 2023 ~ Jan. 29, 2024
Issued Date : Jan. 31, 2024
Report Version : R00
Test Sample : Engineering Sample No.: DG2023122566
Standard(s) : FCC CFR Title 47, Part 15, Subpart E

The above equipment has been tested and found compliance with the requirement of the relative standards by BTL Inc.

Prepared by :

Grani Zhou

Grani Zhou

Approved by :

Steven Lu

Steven Lu

Room 108, Building 2, No. 1, Yile Road, Songshan Lake Zone, Dongguan City, Guangdong
523000 China

Tel: +86-769-8318-3000 Web: www.newbtl.com Service mail: btl_qa@newbtl.com

Declaration

BTL represents to the client that testing is done in accordance with standard procedures as applicable and that test instruments used has been calibrated with standards traceable to international standard(s) and/or national standard(s).

BTL's reports apply only to the specific samples tested under conditions. It is manufacture's responsibility to ensure that additional production units of this model are manufactured with the identical electrical and mechanical components. **BTL** shall have no liability for any declarations, inferences or generalizations drawn by the client or others from **BTL** issued reports.

The report must not be used by the client to claim product certification, approval, or endorsement by NVLAP, NIST, or any agency of the U.S. Government.

This report is the confidential property of the client. As a mutual protection to the clients, the public and ourselves, the test report shall not be reproduced, except in full, without our written approval.

BTL's laboratory quality assurance procedures are in compliance with the ISO/IEC 17025: 2017 requirements, and accredited by the conformity assessment authorities listed in this test report.

BTL is not responsible for the sampling stage, so the results only apply to the sample as received.

The information, data and test plan are provided by manufacturer which may affect the validity of results, so it is manufacturer's responsibility to ensure that the apparatus meets the essential requirements of applied standards and in all the possible configurations as representative of its intended use.

Limitation

For the use of the authority's logo is limited unless the Test Standard(s)/Scope(s)/Item(s) mentioned in this test report is (are) included in the conformity assessment authorities acceptance respective.

Please note that the measurement uncertainty is provided for informational purpose only and are not use in determining the Pass/Fail results.

Table of Contents	Page
REPORT ISSUED HISTORY	4
1 . APPLICABLE STANDARDS	5
2 . SUMMARY OF TEST RESULTS	5
3 . TEST FACILITY	6
4 . TEST ENVIRONMENT CONDITIONS	6
5 . GENERAL INFORMATION	7
5.1 GENERAL DESCRIPTION OF EUT	7
5.2 MAXIMUM OUTPUT POWER AND E.I.R.P.	9
5.3 TRANSMIT POWER CONTROL (TPC)	9
5.4 DESCRIPTION OF TEST MODES	13
6 . U-NII DFS RULE REQUIREMENTS	14
6.1 WORKING MODES AND REQUIRED TEST ITEMS	14
6.2 TEST LIMITS AND RADAR SIGNAL PARAMETERS	15
7 . MEASUREMENT INSTRUMENTS LIST	18
8 . DYNAMIC FREQUENCY SELECTION (DFS)	19
8.1 DFS MEASUREMENT SYSTEM	19
8.2 CALIBRATION OF DFS DETECTION THRESHOLD LEVEL	23
8.3 DEVIATION FROM TEST STANDARD	23
9 . TEST RESULTS	24
9.1 SUMMARY OF DFS TEST RESULT	24
9.2 DFS DETECTION THRESHOLD	25
9.3 RADAR TEST WAVEFORMS	29
9.4 CHANNEL AVAILABILITY CHECK TIME	213
9.5 CHANNEL MOVE TIME AND CHANNEL CLOSING TRANSMISSION TIME	222
9.6 STATISTICAL PERFORMANCE CHECK	226
9.7 NON-OCCUPANCY PERIOD	238
9.8 U-NII DETECTION BANDWIDTH	240
10 . EUT TEST PHOTO	246

REPORT ISSUED HISTORY

Report No.	Version	Description	Issued Date	Note
BTL-FCCP-3-2312C154	R00	Original Report	Jan. 31, 2024	Valid

1. APPLICABLE STANDARDS

According to the specifications of the manufacturer, the EUT must comply with the requirements of the following standards:

KDB 905462 D02 UNII DFS Compliance Procedures New Rules v02

The following reference test guidance is not within the scope of accreditation of NVLAP:

KDB 789033 D02 General U-NII Test Procedures New Rules v02r01

2. SUMMARY OF TEST RESULTS

Test procedures according to the technical standard(s):

FCC CFR Title 47, Part 15, Subpart E				
Standard(s) Section	Test Item	Test Result	Judgment	Remark
FCC 15.407(h)	Transmit Power Control (TPC) and Dynamic Frequency Selection (DFS)	-----	PASS	-----

3. TEST FACILITY

The test facilities used to collect the test data in this report is at the location of Room 108, Building 2, No. 1, Yile Road, Songshan Lake Zone, Dongguan City, Guangdong 523000.

BTL's Registration Number for FCC: 568794



BTL's Designation Number for FCC: CN5041

4. TEST ENVIRONMENT CONDITIONS

Test Item	Temperature	Humidity	Test Voltage	Tested By
Dynamic Frequency Selection (DFS)	21.1~23.4°C	47~48%	DC 12V	Youny Zou

5. GENERAL INFORMATION

5.1 GENERAL DESCRIPTION OF EUT

Equipment	5G Wireless Router
Brand Name	Tozed Kangwei
Test Model	ZLT X100 PRO
Series Model	N/A
Model Difference(s)	N/A
Software Version	V1.0
Hardware Version	TZ7.823.806A
Power Source	DC voltage supplied from AC adapter. 1# Manufacturer / Model: KELI / KL-WA120YYY-G1 2# Manufacturer / Model: JiYin / JYSY018-1201500UD
Power Rating	1# I/P: 100-240V~ 50/60Hz 0.7A O/P: 12V  1.5A 2# I/P: 100-240V~ 50/60Hz 0.5A O/P: 12V  1.5A
Operation Frequency Band(s)	UNII-2A: 5250 MHz ~ 5350 MHz UNII-2C: 5470 MHz ~ 5725 MHz
Modulation Type	IEEE 802.11a/n/ac: OFDM IEEE 802.11ax: OFDMA
Bit Rate of Transmitter	IEEE 802.11a: 54/48/36/24/18/12/9/6 Mbps IEEE 802.11n: up to 300 Mbps IEEE 802.11ac: up to 866.7 Mbps IEEE 802.11ax: up to 1201 Mbps
Operating Mode(s)	<input checked="" type="checkbox"/> Master <input type="checkbox"/> Client device without radar detection <input type="checkbox"/> Client device with radar detection
Maximum Output Power _UNII-2A	IEEE 802.11ax(HE80): 18.53 dBm (0.0713 W)
Maximum Output Power _UNII-2C	IEEE 802.11ac(VHT80): 18.65 dBm (0.0733 W)

Note:

1. For a more detailed features description, please refer to the manufacturer's specifications or the user's manual.

2. Channel List:

IEEE 802.11a IEEE 802.11n(HT20) IEEE 802.11ac(VHT20) IEEE 802.11ax(HE20)		IEEE 802.11n(HT40) IEEE 802.11ac(VHT40) IEEE 802.11ax(HE40)		IEEE 802.11ac(VHT80) IEEE 802.11ax(HE80)	
UNII-2A		UNII-2A		UNII-2A	
Channel	Frequency (MHz)	Channel	Frequency (MHz)	Channel	Frequency (MHz)
52	5260	54	5270	58	5290
56	5280	62	5310		
60	5300				
64	5320				

IEEE 802.11a IEEE 802.11n(HT20) IEEE 802.11ac(VHT20) IEEE 802.11ax(HE20)		IEEE 802.11n(HT40) IEEE 802.11ac(VHT40) IEEE 802.11ax(HE40)		IEEE 802.11ac(VHT80) IEEE 802.11ax(HE80)	
UNII-2C		UNII-2C		UNII-2C	
Channel	Frequency (MHz)	Channel	Frequency (MHz)	Channel	Frequency (MHz)
100	5500	102	5510	106	5530
104	5520	110	5550	122	5610
108	5540	118	5590		
112	5560	126	5630		
116	5580	134	5670		
120	5600				
124	5620				
128	5640				
132	5660				
136	5680				
140	5700				

3. Antenna Specification:

Ant.	Brand	Model Name	Antenna Type	Connector	Gain (dBi)	Note
1	ZTX	X100 PRO WIFI-1	PCB	N/A	5.54	UNII-1
					5.92	UNII-2A
					6.62	UNII-2C
					5.69	UNII-3
2	ZTX	X100 PRO WIFI-2	PCB	N/A	6.46	UNII-1
					6.35	UNII-2A
					7.36	UNII-2C
					7.65	UNII-3

Note:

- This EUT supports MIMO, any transmit signals are correlated with each other, so Directional gain= $10\log[(10^{G1/20}+10^{G2/20}+\dots+10^{GN/20})^2/N]$ dBi, that is Directional gain= $10\log[(10^{6.62/20}+10^{7.65/20})^2/2]$ dBi =10.16.
- The antenna gain is provided by the manufacturer.

4. Table for Antenna Configuration:

Operating Mode	TX Mode	2TX
IEEE 802.11a		V (Ant. 1 + Ant. 2)
IEEE 802.11n(HT20)		V (Ant. 1 + Ant. 2)
IEEE 802.11n(HT40)		V (Ant. 1 + Ant. 2)
IEEE 802.11ac(VHT20)		V (Ant. 1 + Ant. 2)
IEEE 802.11ac(VHT40)		V (Ant. 1 + Ant. 2)
IEEE 802.11ac(VHT80)		V (Ant. 1 + Ant. 2)
IEEE 802.11ax(HE20)		V (Ant. 1 + Ant. 2)
IEEE 802.11ax(HE40)		V (Ant. 1 + Ant. 2)
IEEE 802.11ax(HE80)		V (Ant. 1 + Ant. 2)

5.2 MAXIMUM OUTPUT POWER AND E.I.R.P.

Frequency Band (MHz)	Max Output Power (dBm)	Directional gain (dBi)	Max. e.i.r.p. (dBm)	Max. e.i.r.p. (mW)
5250~5350	18.53	10.16	28.69	739.6053
5470~5725	18.65	10.16	28.81	760.3263

Note:

- U-NII devices operating in the 5.25-5.35 GHz band and the 5.47-5.725 GHz band shall employ a TPC mechanism. A TPC mechanism is not required for systems with an e.i.r.p. of less than 500 mW.

5.3 TRANSMIT POWER CONTROL (TPC)

The U-NII device is required to have the capability to operate at least 6 dB below the mean EIRP value of 30 dBm.

Test Mode: UNII-2A / IEEE 802.11a Mode			
Channel	Frequency (MHz)	Output Power (TPC High) (dBm)	Output Power (TPC Low) (dBm)
52	5260	15.97	9.97
60	5300	15.83	9.83
64	5320	15.71	9.71

Test Mode: UNII-2A / IEEE 802.11n(HT20) Mode			
Channel	Frequency (MHz)	Output Power (TPC High) (dBm)	Output Power (TPC Low) (dBm)
52	5260	15.85	9.85
60	5300	15.71	9.71
64	5320	15.57	9.57

Test Mode: UNII-2A / IEEE 802.11n(HT40) Mode			
Channel	Frequency (MHz)	Output Power (TPC High) (dBm)	Output Power (TPC Low) (dBm)
54	5270	18.06	12.06
62	5310	17.84	11.84

Test Mode: UNII-2A / IEEE 802.11ac(VHT20) Mode			
Channel	Frequency (MHz)	Output Power (TPC High) (dBm)	Output Power (TPC Low) (dBm)
52	5260	16.12	10.12
60	5300	15.89	9.89
64	5320	15.74	9.74

Test Mode: UNII-2A / IEEE 802.11ac(VHT40) Mode			
Channel	Frequency (MHz)	Output Power (TPC High) (dBm)	Output Power (TPC Low) (dBm)
54	5270	17.99	11.99
62	5310	17.79	11.79

Test Mode: UNII-2A / IEEE 802.11ac(VHT80) Mode			
Channel	Frequency (MHz)	Output Power (TPC High) (dBm)	Output Power (TPC Low) (dBm)
58	5290	17.90	11.90

Test Mode: UNII-2A / IEEE 802.11ax(HE20) Mode			
Channel	Frequency (MHz)	Output Power (TPC High) (dBm)	Output Power (TPC Low) (dBm)
52	5260	16.17	10.17
60	5300	16.36	10.36
64	5320	16.07	10.07

Test Mode: UNII-2A / IEEE 802.11ax(HE40) Mode			
Channel	Frequency (MHz)	Output Power (TPC High) (dBm)	Output Power (TPC Low) (dBm)
54	5270	17.81	11.81
62	5310	18.21	12.21

Test Mode: UNII-2A / IEEE 802.11ax(HE80) Mode			
Channel	Frequency (MHz)	Output Power (TPC High) (dBm)	Output Power (TPC Low) (dBm)
58	5290	18.53	12.53

Test Mode: UNII-2C / IEEE 802.11a Mode			
Channel	Frequency (MHz)	Output Power (TPC High) (dBm)	Output Power (TPC Low) (dBm)
100	5500	15.26	9.26
116	5580	16.00	10.00
140	5700	14.45	8.45

Test Mode: UNII-2C / IEEE 802.11n(HT20) Mode			
Channel	Frequency (MHz)	Output Power (TPC High) (dBm)	Output Power (TPC Low) (dBm)
100	5500	15.10	9.10
116	5580	15.53	9.53
140	5700	14.59	8.59

Test Mode: UNII-2C / IEEE 802.11n(HT40) Mode			
Channel	Frequency (MHz)	Output Power (TPC High) (dBm)	Output Power (TPC Low) (dBm)
102	5510	18.13	12.13
110	5550	18.01	12.01
134	5670	17.91	11.91

Test Mode: UNII-2C / IEEE 802.11ac(VHT20) Mode			
Channel	Frequency (MHz)	Output Power (TPC High) (dBm)	Output Power (TPC Low) (dBm)
100	5500	15.33	9.33
116	5580	15.63	9.63
140	5700	15.56	9.56

Test Mode: UNII-2C / IEEE 802.11ac(VHT40) Mode			
Channel	Frequency (MHz)	Output Power (TPC High) (dBm)	Output Power (TPC Low) (dBm)
102	5510	17.98	11.98
110	5550	17.92	11.92
134	5670	17.78	11.78

Test Mode: UNII-2C / IEEE 802.11ac(VHT80) Mode			
Channel	Frequency (MHz)	Output Power (TPC High) (dBm)	Output Power (TPC Low) (dBm)
106	5530	18.05	12.05
122	5610	18.65	12.65

Test Mode: UNII-2C / IEEE 802.11ax(HE20) Mode			
Channel	Frequency (MHz)	Output Power (TPC High) (dBm)	Output Power (TPC Low) (dBm)
100	5500	15.49	9.49
116	5580	16.42	10.42
140	5700	15.41	9.41

Test Mode: UNII-2C / IEEE 802.11ax(HE40) Mode			
Channel	Frequency (MHz)	Output Power (TPC High) (dBm)	Output Power (TPC Low) (dBm)
102	5510	18.28	12.28
110	5550	18.22	12.22
134	5670	18.07	12.07

Test Mode: UNII-2C / IEEE 802.11ax(HE80) Mode			
Channel	Frequency (MHz)	Output Power (TPC High) (dBm)	Output Power (TPC Low) (dBm)
106	5530	18.45	12.45
122	5610	18.27	12.27

5.4 DESCRIPTION OF TEST MODES

Test Mode	Description
Mode 1	IEEE 802.11a: 5320MHz
Mode 2	IEEE 802.11ac(VHT40): 5310MHz
Mode 3	IEEE 802.11ax(HE80): 5290MHz

Note:

(1) IEEE 802.11ax mode only supports full RU, so only the full RU is evaluated and measured inside report

6. U-NII DFS RULE REQUIREMENTS

6.1 WORKING MODES AND REQUIRED TEST ITEMS

The manufacturer shall state whether the UUT is capable of operating as a Master and/or a Client. If the UUT is capable of operating in more than one operating mode then each operating mode shall be tested separately. See tables below for the applicability of DFS requirements for each of the operational modes.

Applicability of DFS requirements prior to use a channel

Requirement	Operational Mode		
	Master	Client without radar detection	Client with radar detection
Non-Occupancy Period	√	√	√
DFS Detection Threshold	√	Not required	√
Channel Availability Check Time	√	Not required	Not required
U-NII Detection Bandwidth	√	Not required	√

Applicability of DFS requirements during normal operation

Requirement	Operational Mode		
	Master	Client without radar detection	Client with radar detection
DFS Detection Threshold	√	Not required	√
Channel Closing Transmission Time	√	√	√
Channel Move Time	√	√	√
U-NII Detection Bandwidth	√	Not required	√

Additional requirements for devices with multiple bandwidth modes	Master Device or Client with Radar Detection	Client Without Radar Detection
U-NII Detection Bandwidth and Statistical Performance Check	All BW modes must be tested	Not required
Channel Move Time and Channel Closing Transmission Time	Test using widest BW mode available	Test using the widest BW mode available for the link
All other tests	Any single BW mode	Not required

Note: Frequencies selected for statistical performance check should include several frequencies within the radar detection bandwidth and frequencies near the edge of the radar detection bandwidth. For 802.11 devices it is suggested to select frequencies in each of the bonded 20 MHz channels and the channel center frequency.

6.2 TEST LIMITS AND RADAR SIGNAL PARAMETERS

DETECTION THRESHOLD VALUES

DFS Detection Thresholds for Master Devices and Client Devices with Radar Detection

Maximum Transmit Power	Value (See Notes 1, 2 and 3)
e.i.r.p. \geq 200 milliwatt	-64 dBm
e.i.r.p. < 200 milliwatt and power spectral density < 10 dBm/MHz	-62 dBm
e.i.r.p. < 200 milliwatt that do not meet the power spectral density requirement	-64 dBm

Note 1: This is the level at the input of the receiver assuming a 0 dBi receive antenna.

Note 2: Throughout these test procedures an additional 1 dB has been added to the amplitude of the test transmission waveforms to account for variations in measurement equipment. This will ensure that the test signal is at or above the detection threshold level to trigger a DFS response.

Note 3: e.i.r.p. is based on the highest antenna gain. For MIMO devices refer to KDB Publication 662911 D01.

TEST LIMIT

DFS Response Requirement Values

Parameter	Value
Non-occupancy period	Minimum 30 minutes
Channel Availability Check Time	60 seconds
Channel Move Time	10 seconds. See Note 1.
Channel Closing Transmission Time	200 milliseconds + an aggregate of 60 milliseconds over remaining 10 second period. See Notes 1 and 2.
U-NII Detection Bandwidth	Minimum 100% of the UNII 99% transmission power bandwidth. See Note 3.

Note 1: Channel Move Time and the Channel Closing Transmission Time should be performed with Radar Type 0. The measurement timing begins at the end of the Radar Type 0 burst.

Note 2: The Channel Closing Transmission Time is comprised of 200 milliseconds starting at the beginning of the Channel Move Time plus any additional intermittent control signals required to facilitate a Channel move (an aggregate of 60 milliseconds) during the remainder of the 10 second period. The aggregate duration of control signals will not count quiet periods in between transmissions.

Note 3: During the U-NII Detection Bandwidth detection test, radar type 0 should be used. For each frequency step the minimum percentage of detection is 90 percent. Measurements are performed with no data traffic.

PARAMETERS OF DFS TEST SIGNALS AND MINIMUM PERCENTAGE OF SUCCESSFUL DETECTIONS

Step intervals of 0.1 microsecond for Pulse Width, 1 microsecond for PRI, 1 MHz for chirp width and 1 for the number of pulses will be utilized for the random determination of specific test waveforms.

Short Pulse Radar Test Waveforms.

Radar Type	Pulse Width (μsec)	PRI (μsec)	Number of Pulses	Minimum Percentage of Successful Detection	Minimum Number of Trials
0	1	1428	18	See Note 1	See Note 1
1	1	Test A: 15 unique PRI values randomly selected from the list of 23 PRI values in Table 5a	$\text{Roundup} \left\{ \left(\frac{1}{360} \right) \cdot \left(\frac{19 \cdot 10^6}{\text{PRI}_{\mu\text{sec}}} \right) \right\}$	60%	30
		Test B: 15 unique PRI values randomly selected within the range of 518-3066 μsec, with a minimum increment of 1 μsec, excluding PRI values selected in Test A			
2	1-5	150-230	23-29	60%	30
3	6-10	200-500	16-18	60%	30
4	11-20	200-500	12-16	60%	30
Aggregate (Radar Types 1-4)				80%	120
Note 1: Short Pulse Radar Type 0 should be used for the detection bandwidth test, channel move time, and channel closing time tests.					

A minimum of 30 unique waveforms are required for each of the Short Pulse Radar Types 2 through 4. If more than 30 waveforms are used for Short Pulse Radar Types 2 through 4, then each additional waveform must also be unique and not repeated from the previous waveforms. If more than 30 waveforms are used for Short Pulse Radar Type 1, then each additional waveform is generated with Test B and must also be unique and not repeated from the previous waveforms in Tests A or B.

For example if in Short Pulse Radar Type 1 Test B a PRI of 3066 usec is selected, the number of pulses

would be $\text{Roundup} \left\{ \left(\frac{1}{360} \right) \cdot \left(\frac{19 \cdot 10^6}{3066} \right) \right\} = \text{Round up } \{17.2\} = 18.$

Table 5a - Pulse Repetition Intervals Values for Test A

Pulse Repetition Frequency Number	Pulse Repetition Frequency (Pulses Per Second)	Pulse Repetition Interval (Microseconds)
1	1930.5	518
2	1858.7	538
3	1792.1	558
4	1730.1	578
5	1672.2	598
6	1618.1	618
7	1567.4	638
8	1519.8	658
9	1474.9	678
10	1432.7	698
11	1392.8	718
12	1355	738
13	1319.3	758
14	1285.3	778
15	1253.1	798
16	1222.5	818
17	1193.3	838
18	1165.6	858
19	1139	878
20	1113.6	898
21	1089.3	918
22	1066.1	938
23	326.2	3066

The aggregate is the average of the percentage of successful detections of Short Pulse Radar Types 1-4.

Long Pulse Radar Test Waveform

Radar Type	Pulse Width (µsec)	Chirp Width (MHz)	PRI (µsec)	Number of Pulses per Burst	Number of Bursts	Minimum Percentage of Successful Detection	Minimum Number of Trials
5	50-100	5-20	1000-2000	1-3	8-20	80%	30

The parameters for this waveform are randomly chosen (The center frequency for each of the 30 trials of the Bin 5 radar shall be randomly selected within 80% of the Occupied Bandwidth.) Thirty unique waveforms are required for the Long Pulse Radar Type waveforms. If more than 30 waveforms are used for the Long Pulse Radar Type waveforms, then each additional waveform must also be unique and not repeated from the previous waveforms.

Frequency Hopping Radar Test Waveform

Radar Type	Pulse Width (µsec)	PRI (µsec)	Pulses per Hop	Hopping Rate (kHz)	Hopping Sequence Length (msec)	Minimum Percentage of Successful Detection	Minimum Number of Trials
6	1	333	9	0.333	300	70%	30

For the Frequency Hopping Radar Type, the same Burst parameters are used for each waveform. The hopping sequence is different for each waveform and a 100-length segment is selected from the hopping sequence defined by the following algorithm: If a segment does not contain at least 1 frequency within the U-NII Detection Bandwidth of the UUT, then that segment is not used.

The first frequency in a hopping sequence is selected randomly from the group of 475 integer frequencies from 5250 - 5724 MHz. Next, the frequency that was just chosen is removed from the group and a frequency is randomly selected from the remaining 474 frequencies in the group. This process continues until all 475 frequencies are chosen for the set. For selection of a random frequency, the frequencies remaining within the group are always treated as equally likely.

7. MEASUREMENT INSTRUMENTS LIST

Kind of Equipment	Manufacturer	Type No.	Serial No.	Calibrated until
Attenuator	RegalWay	RWPA-6000-110-MA	NA	Sep. 27, 2024
Attenuator	RegalWay	RWA-201-S-10	NA	Sep. 26, 2024
Cable	RegalWay	RWP50-402-SMSM-1M	NA	Aug. 27, 2024
Cable	RegalWay	RWP50-402-SMSM-1M	NA	Aug. 27, 2024
Cable	RegalWay	RWP50-402-SMSM-1M	NA	Aug. 27, 2024
Cable	RegalWay	RWP50-402-SMSM-0.5M	NA	Aug. 27, 2024
Cable	RegalWay	RWP50-402-SMSM-0.5M	NA	Aug. 27, 2024
Power Splitter	RegalWay	RW-PD4-0118SF30	NA	Sep. 26, 2024
Power Divider	RegalWay	RWPD2-DC27-S	NA	Sep. 26, 2024
Power Divider	RegalWay	RWPD2-DC27-S	NA	Sep. 26, 2024
DFS radar profiles 2022 update 1.0	Keysight	N/A	N/A	N/A
Digital Multimeter	FLUKE	15B PRO	59056265WS	Sep. 25, 2024
Torque Wrenc	Eastsheep	1.35N.m-12IN.LBS	NA	Sep. 24, 2024
Torque Wrenc	PLARZ	SP-01009	NA	Sep. 24, 2024
MXA Signal Analyzer	Keysight	N9010A	MY56480543	Mar. 17, 2024
MXG Vector Signal Generator	Keysight	N5182B	MY57300602	Jul. 21, 2024

Remark: "N/A" denotes no model name, serial no. or calibration specified.
All calibration period of equipment list is one year.

8. DYNAMIC FREQUENCY SELECTION (DFS)

8.1 DFS MEASUREMENT SYSTEM

Test Procedure

1. Master device and client device are set up by conduction method as the following configuration.
2. The client device is connected to notebook and to access a IP address on wireless connection with the master device.
3. Then the master device is connected to another notebook to access a IP address.
4. Finally, let the two IP addresses run traffic with each other through the Run flow software "Lan test" to reach 17% channel loading as below.

Setup for Master with injection at the Master

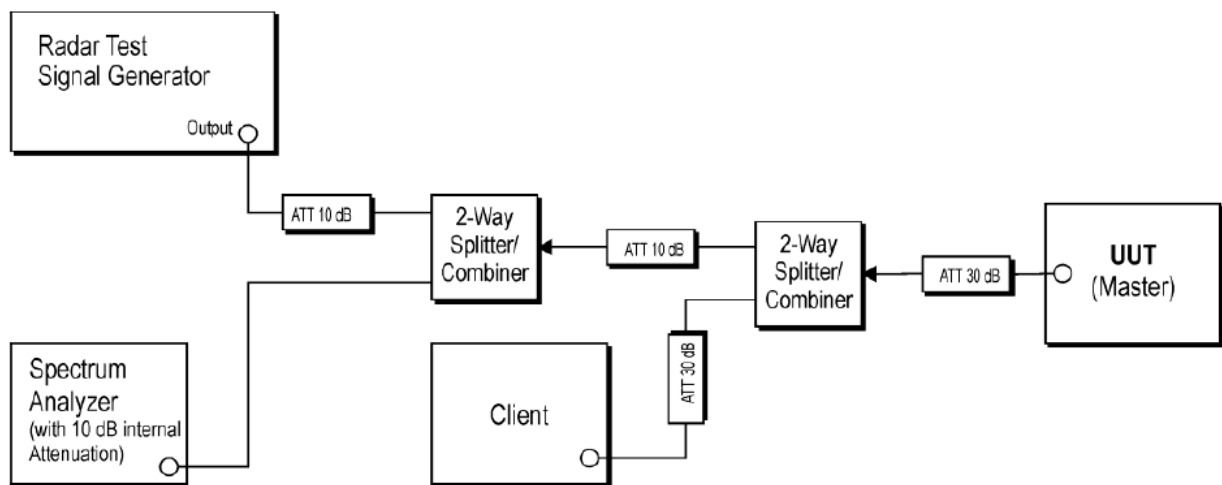

Radar Test Waveforms are injected into the Master.

Channel Loading

IEEE 802.11a Mode

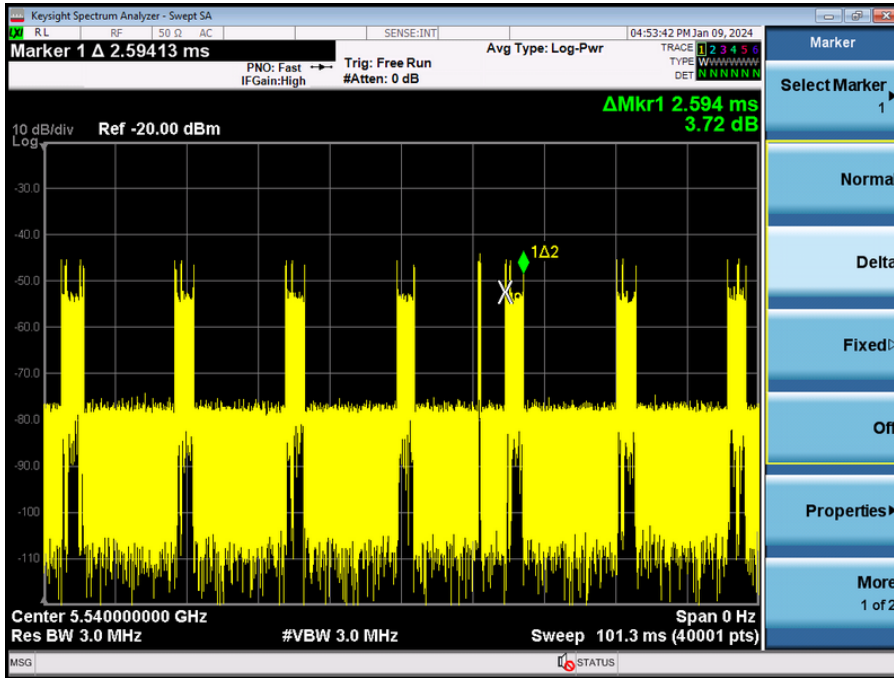

IEEE 802.11ac(VHT40) Mode

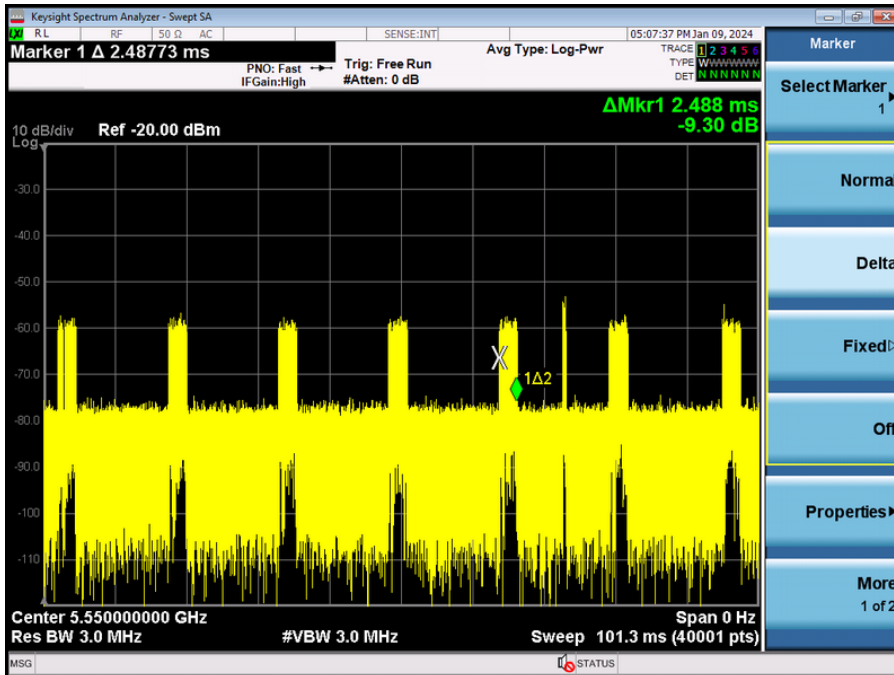

IEEE 802.11ax(HE80) Mode

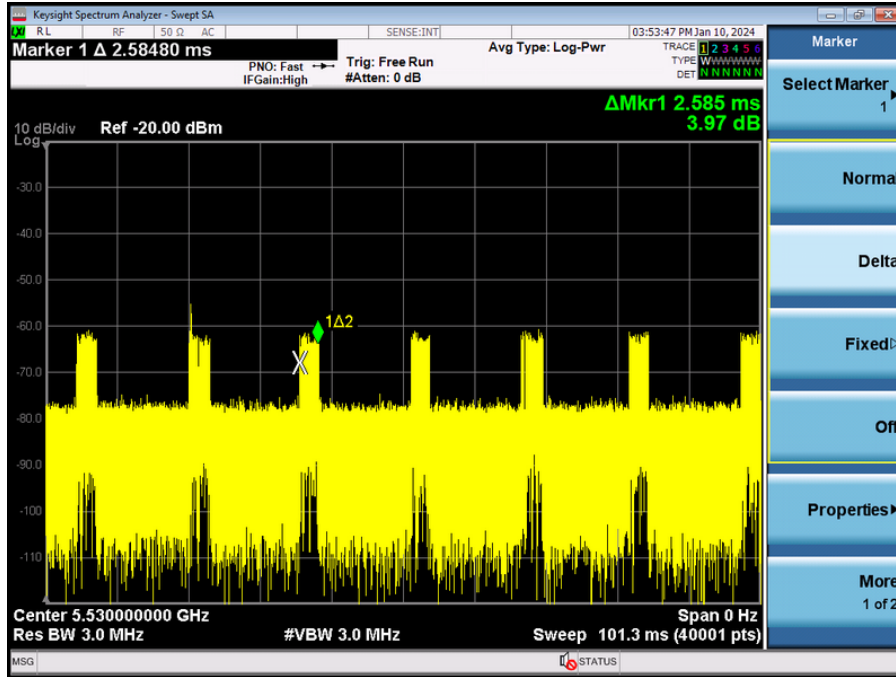

Frequency (MHz)	Marker Delta (ms)	Number	On Time (ms)	Total Time (ms)	Duty cycle (%)	Limit (%)
5540	2.594	7	18.158	101.3	17.92	17
5550	2.488	7	17.416	101.3	17.19	17
5530	2.585	7	18.095	101.3	17.86	17

The hopping type 6 pulse parameters are fixed while the hopping sequence is based on the August 2005 NTIA Hopping Frequency List. The initial starting point randomized at run-time and each subsequent starting point is incremented by 475. Each frequency in the 100-length segment is compared to the boundaries of the EUT Detection Bandwidth and the software creates a hopping burst pattern in accordance with Section 7.4.1.3 Method #2 Simulated Frequency Hopping Radar Waveform Generating Subsystem of FCC 06-96. The frequency of the signal generator is incremented in 1 MHz steps from FL to FH for each successive trial. This incremental sequence is repeated as required to generate a minimum of 30 total trials and to maintain a uniform frequency distribution over the entire Detection Bandwidth.

The signal monitoring equipment consists of a spectrum analyzer set to display 8001 bins on the horizontal axis. The time-domain resolution is 2 msec / bin with a 16 second sweep time, meeting the 10 second short pulse reporting criteria. The aggregate ON time is calculated by multiplying the number of bins above a threshold during a particular observation period by the dwell time per bin, with the analyzer set to peak detection and max hold.

Should multiple RF ports be utilized for the Master and/or Slave devices (for example, for diversity or MIMO implementations), additional combiner/dividers are inserted between the Master Combiner/Divider and the pad connected to the Master Device (and/or between the Slave Combiner/Divider and the pad connected to the Slave Device). Additional pads are utilized such that there is one pad at each RF port on each EUT.

8.2 CALIBRATION OF DFS DETECTION THRESHOLD LEVEL

A 50 ohm load is connected in place of the spectrum analyzer, and the spectrum analyzer is connected in place of the master device and the signal generator is set to CW mode. The amplitude of the signal generator is adjusted to yield a level of -64dBm as measured on the spectrum analyzer.

Without changing any of the instrument settings, the spectrum analyzer is reconnected to the Common port of the Spectrum Analyzer Combiner/Divider. Measure the amplitude and calculate the difference from -64 dBm. Adjust the Reference Level Offset of the spectrum analyzer to this difference.

The spectrum analyzer displays the level of the signal generator as received at the antenna ports of the Master Device. The interference detection threshold may be varied from the calibrated value of -64 dBm and the spectrum analyzer will still indicate the level as received by the Master Device.

Set the signal generator to produce a radar waveform, trigger a burst manually and measure the level on the spectrum analyzer. Readjust the amplitude of the signal generator as required so that the peak level of the waveform is at a displayed level equal to the required or desired interference detection threshold. Separate signal generator amplitude settings are determined as required for each radar type.

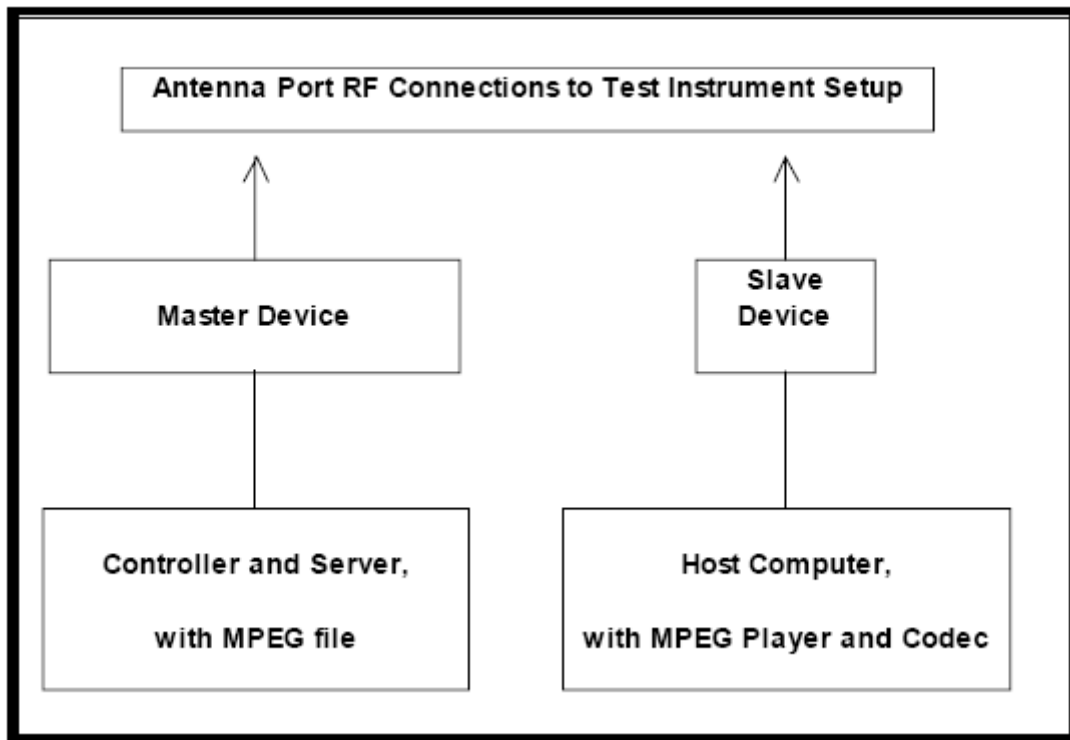

8.3 DEVIATION FROM TEST STANDARD

No deviation.

9. TEST RESULTS**9.1 SUMMARY OF DFS TEST RESULT**

Clause	Test Parameter	Remarks	Result
FCC 15.407	DFS Detection Threshold	Applicable	Pass
	Channel Availability Check Time	Applicable	Pass
	Channel Move Time	Applicable	Pass
	Channel Closing Transmission Time	Applicable	Pass
	Non-Occupancy Period	Applicable	Pass
	U-NII Detection Bandwidth	Applicable	Pass

9.2 DFS DETECTION THRESHOLD

Calibration:

For a detection threshold level of -64dBm and the antenna gain is 0 dBi, required detection threshold is -64 dBm.

Note: Maximum Transmit Power is more than 200 milliwatt in this report, so detection threshold level is -64dBm.

Radar Signal 0

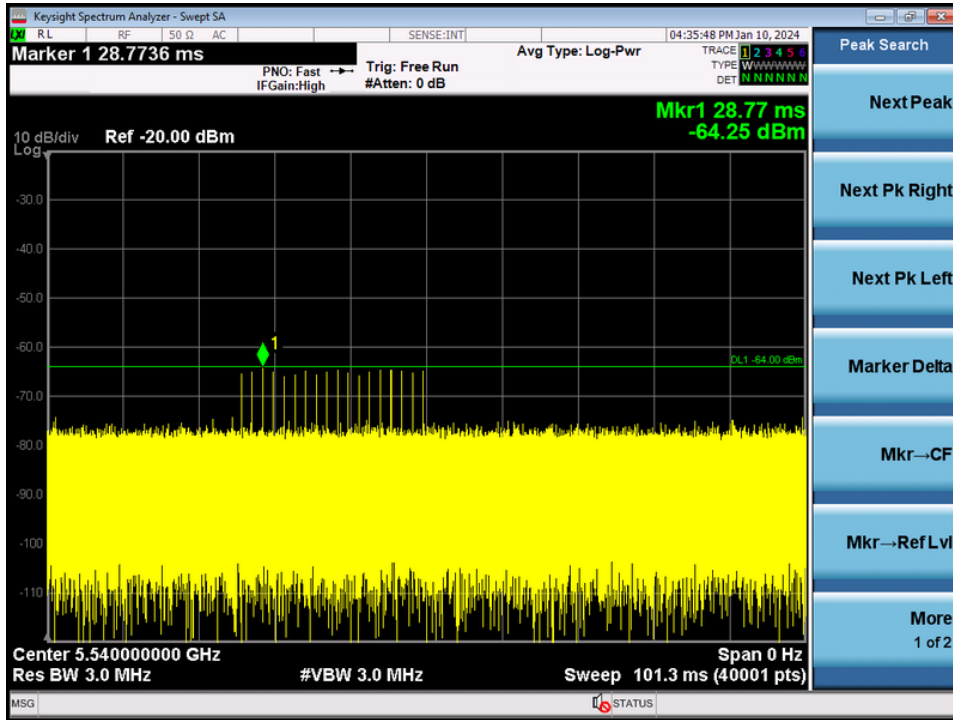

Radar Signal 1

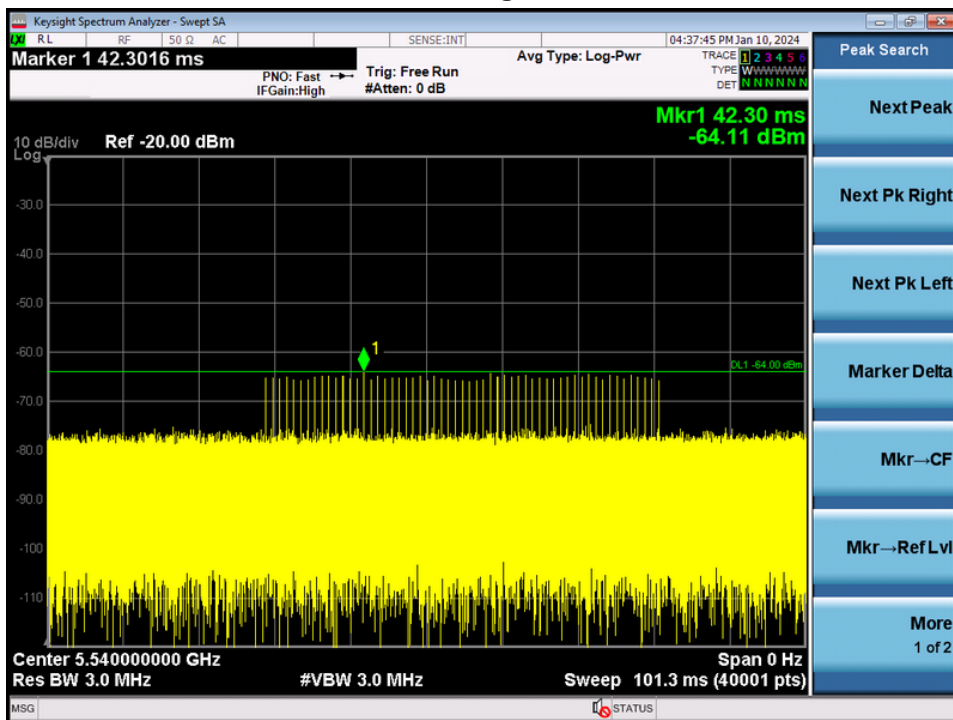

Radar Signal 2

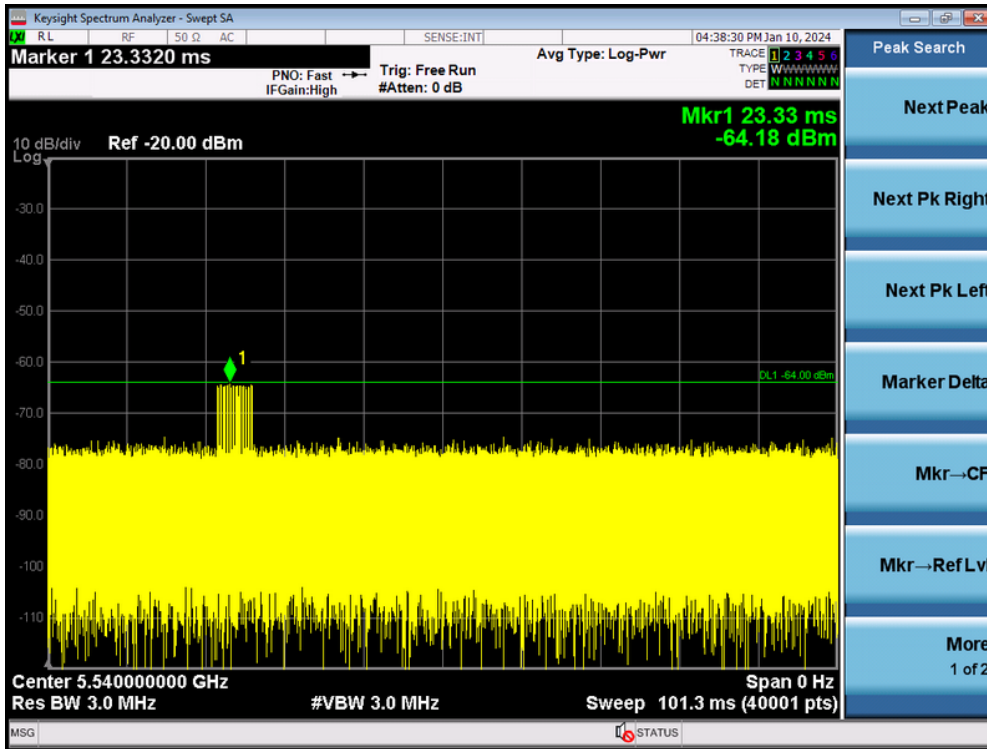

Radar Signal 3

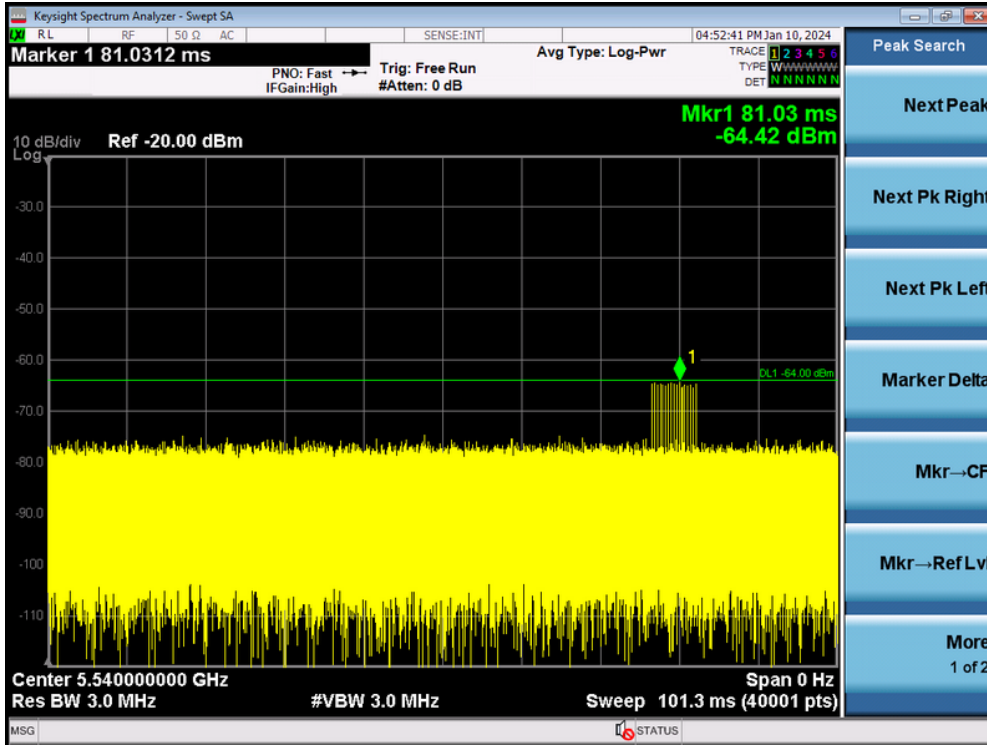

Radar Signal 4

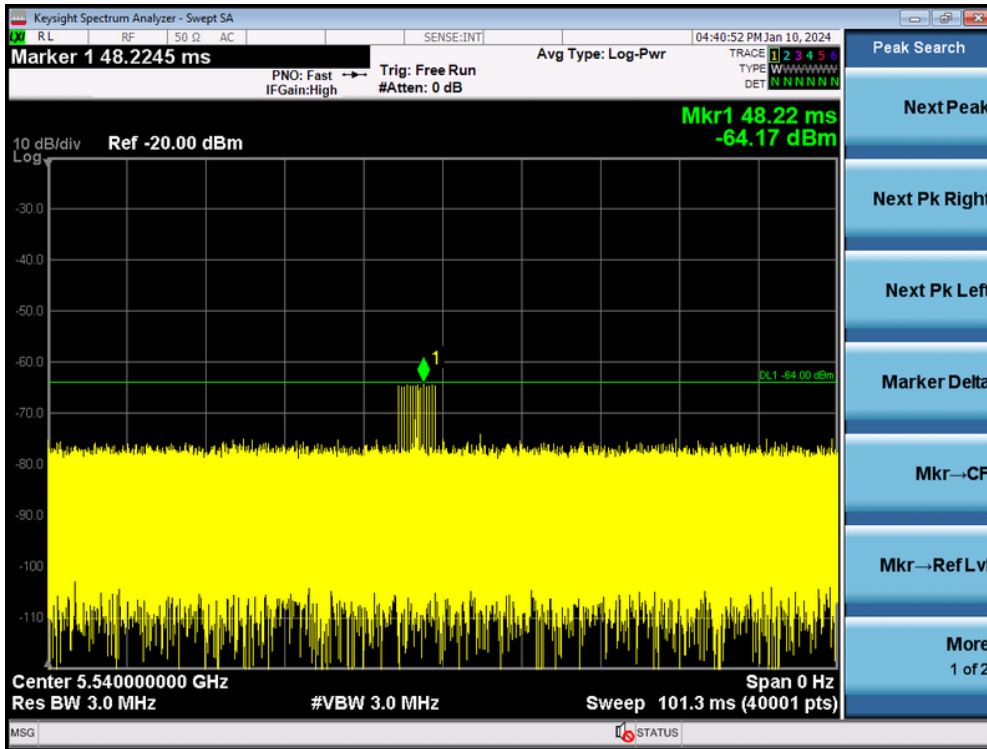

Radar Signal 5

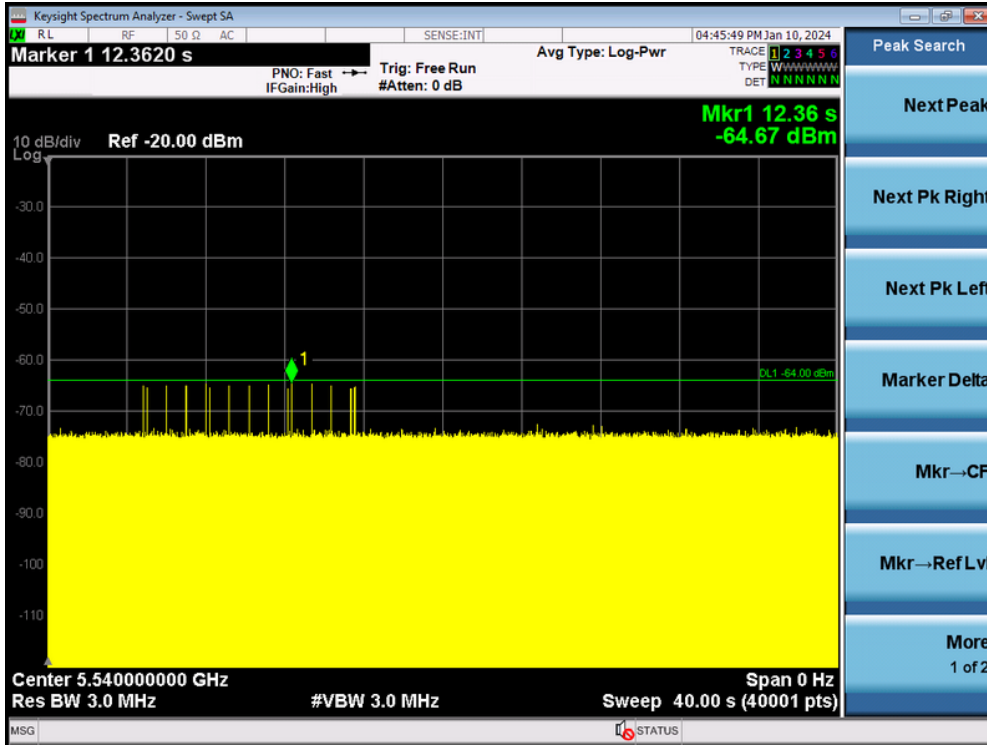

Radar Signal 6

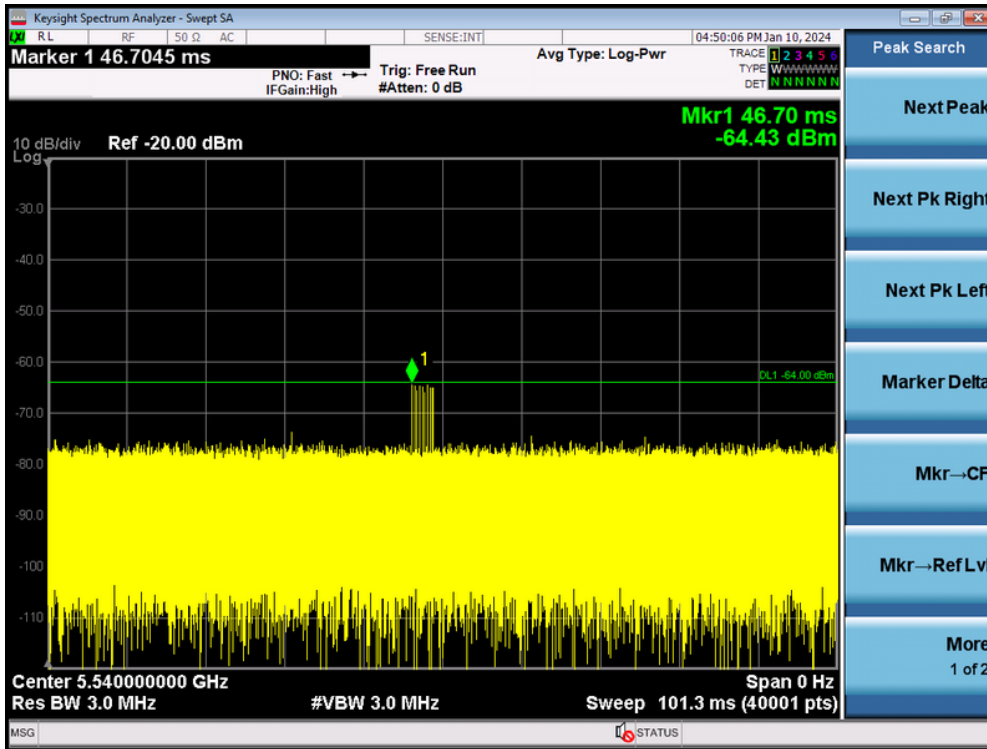

9.3 RADAR TEST WAVEFORMS**Radar Signal 0**

Trial ID	Radar Type	Pulse Width (μs)	PRI (μs)	Number of Pulses	Waveform Length (μs)
0	Type 0	1	1428	18	25704

Radar Signal 1

Trial ID	Radar Type	Pulse Width (μs)	PRI (μs)	Number of Pulses	Waveform Length (μs)
0	Type 1	1	938	57	53466
1	Type 1	1	698	76	53048
2	Type 1	1	618	86	53148
3	Type 1	1	538	99	53262
4	Type 1	1	878	61	53558
5	Type 1	1	3066	18	55188
6	Type 1	1	638	83	52954
7	Type 1	1	918	58	53244
8	Type 1	1	838	63	52794
9	Type 1	1	858	62	53196
10	Type 1	1	798	67	53466
11	Type 1	1	718	74	53132
12	Type 1	1	578	92	53176
13	Type 1	1	598	89	53222
14	Type 1	1	558	95	53010
15	Type 1	1	2536	21	53256
16	Type 1	1	966	55	53130
17	Type 1	1	827	64	52928
18	Type 1	1	2501	22	55022
19	Type 1	1	2595	21	54495
20	Type 1	1	1114	48	53472
21	Type 1	1	1302	41	53382
22	Type 1	1	3045	18	54810
23	Type 1	1	1624	33	53592
24	Type 1	1	2878	19	54682
25	Type 1	1	1027	52	53404
26	Type 1	1	2485	22	54670
27	Type 1	1	1600	33	52800
28	Type 1	1	1172	46	53912
29	Type 1	1	1177	45	52965

Radar Signal 2

Trial ID	Radar Type	Pulse Width (μs)	PRI (μs)	Number of Pulses	Waveform Length (μs)
0	Type 2	3.2	179	26	4654
1	Type 2	1.1	207	23	4761
2	Type 2	2.1	230	24	5520
3	Type 2	4.8	200	29	5800
4	Type 2	3.9	214	28	5992
5	Type 2	2.9	222	26	5772
6	Type 2	3.2	204	26	5304
7	Type 2	2.5	192	25	4800
8	Type 2	3.1	164	26	4264
9	Type 2	1.2	156	23	3588
10	Type 2	3.9	210	27	5670
11	Type 2	4.6	201	29	5829
12	Type 2	3.2	162	26	4212
13	Type 2	2.2	197	25	4925
14	Type 2	4.5	163	29	4727
15	Type 2	3	203	26	5278
16	Type 2	5	168	29	4872
17	Type 2	2.4	217	25	5425
18	Type 2	2.9	191	26	4966
19	Type 2	2.3	166	25	4150
20	Type 2	3.7	150	27	4050
21	Type 2	2.2	176	25	4400
22	Type 2	4.9	195	29	5655
23	Type 2	2.9	202	26	5252
24	Type 2	2.5	178	25	4450
25	Type 2	1.1	206	23	4738
26	Type 2	3.8	155	27	4185
27	Type 2	4.7	157	29	4553
28	Type 2	2.4	224	25	5600
29	Type 2	4.2	159	28	4452

Radar Signal 3

Trial ID	Radar Type	Pulse Width (µs)	PRI (µs)	Number of Pulses	Waveform Length (µs)
0	Type 3	8.2	355	17	6035
1	Type 3	6.1	487	16	7792
2	Type 3	7.1	344	16	5504
3	Type 3	9.8	288	18	5184
4	Type 3	8.9	230	18	4140
5	Type 3	7.9	432	17	7344
6	Type 3	8.2	207	17	3519
7	Type 3	7.5	443	17	7531
8	Type 3	8.1	439	17	7463
9	Type 3	6.2	223	16	3568
10	Type 3	8.9	208	18	3744
11	Type 3	9.6	463	18	8334
12	Type 3	8.2	441	17	7497
13	Type 3	7.2	323	16	5168
14	Type 3	9.5	297	18	5346
15	Type 3	8	412	17	7004
16	Type 3	10	324	18	5832
17	Type 3	7.4	271	17	4607
18	Type 3	7.9	349	17	5933
19	Type 3	7.3	409	16	6544
20	Type 3	8.7	373	18	6714
21	Type 3	7.2	254	16	4064
22	Type 3	9.9	274	18	4932
23	Type 3	7.9	278	17	4726
24	Type 3	7.5	317	17	5389
25	Type 3	6.1	260	16	4160
26	Type 3	8.8	211	18	3798
27	Type 3	9.7	272	18	4896
28	Type 3	7.4	264	17	4488
29	Type 3	9.2	284	18	5112

Radar Signal 4

Trial ID	Radar Type	Pulse Width (µs)	PRI (µs)	Number of Pulses	Waveform Length (µs)
0	Type 4	16	355	14	4970
1	Type 4	11.3	487	12	5844
2	Type 4	13.5	344	13	4472
3	Type 4	19.4	288	16	4608
4	Type 4	17.5	230	15	3450
5	Type 4	15.3	432	14	6048
6	Type 4	15.9	207	14	2898
7	Type 4	14.3	443	13	5759
8	Type 4	15.8	439	14	6146
9	Type 4	11.5	223	12	2676
10	Type 4	17.4	208	15	3120
11	Type 4	19	463	16	7408
12	Type 4	16	441	14	6174
13	Type 4	13.8	323	13	4199
14	Type 4	18.9	297	16	4752
15	Type 4	15.5	412	14	5768
16	Type 4	19.9	324	16	5184
17	Type 4	14.1	271	13	3523
18	Type 4	15.2	349	14	4886
19	Type 4	13.8	409	13	5317
20	Type 4	17.1	373	15	5595
21	Type 4	13.8	254	13	3302
22	Type 4	19.8	274	16	4384
23	Type 4	15.3	278	14	3892
24	Type 4	14.5	317	13	4121
25	Type 4	11.3	260	12	3120
26	Type 4	17.3	211	15	3165
27	Type 4	19.2	272	16	4352
28	Type 4	14.2	264	13	3432
29	Type 4	18.2	284	15	4260

Radar Signal 5_5320 MHz

Trial ID	Radar Type	Number of Bursts	Burst Period(s)	Wave from Length (s)	Center Frequency(GHz)	-		
0	Type 5	15	0.8	12	5.32	-		
	Burst ID	Burst Offset (μs)	Pulse Width (μs)	Chirp Width (MHz)	Number of Pulses per Burst	PRI-1 (μs)	PRI-2 (μs)	PRI-3 (μs)
	0	636185	77.8	13	2	1665	1477	-
	1	32674	51.9	13	1	1074	-	-
	2	226294	63.8	13	1	1584	-	-
	3	417976	96.6	13	3	1682	1786	1843
	4	611152	85.9	13	3	1795	1215	1729
	5	8789	73.7	13	2	1198	1549	-
	6	201917	77.2	13	2	1837	1819	-
	7	395530	68.4	13	2	1587	1114	-
	8	588564	76.7	13	2	2000	1155	-
	9	783794	53.2	13	1	1147	-	-
	10	177933	85.7	13	3	1433	1695	1394
	11	370624	94.3	13	3	1670	1426	1935
	12	564893	77.6	13	2	1294	1671	-
	13	759583	65.7	13	1	1512	-	-
	14	154262	93.5	13	3	1444	1130	1468
1	Type 5	8	1.5	12	5.32			
	Burst ID	Burst Offset (μs)	Pulse Width (μs)	Chirp Width (MHz)	Number of Pulses per Burst	PRI-1 (μs)	PRI-2 (μs)	PRI-3 (μs)
	0	653020	75	5	2	1880	1527	-
	1	1015643	99.4	5	3	1401	1262	1257
	2	1379398	67.4	5	2	1531	1403	-
	3	245489	73.6	5	2	1449	1041	-
	4	609113	65.9	5	1	1432	-	-
	5	970852	83.8	5	3	1356	1292	1419
	6	1335913	65.5	5	1	1543	-	-
	7	200406	98.6	5	3	1548	1796	1728

Trial ID	Radar Type	Number of Bursts	Burst Period(s)	Wave from Length (s)	Center Frequency(GHz)	-		
2	Type 5	11	1.0909091	12	5.32			
	Burst ID	Burst Offset (μs)	Pulse Width (μs)	Chirp Width (MHz)	Number of Pulses per Burst	PRI-1 (μs)	PRI-2 (μs)	PRI-3 (μs)
	0	409565	73.8	9	2	1806	1538	-
	1	673692	69.5	9	2	1117	1649	-
	2	938562	51.9	9	1	1651	-	-
	3	113209	84.6	9	3	1976	1032	1271
	4	376726	95.4	9	3	1060	1903	1388
	5	641212	68	9	2	1368	1351	-
	6	903714	89.6	9	3	1338	1514	1573
	7	80863	81.9	9	2	1022	1689	-
	8	344067	88.3	9	3	1810	1330	1838
	9	609331	53.7	9	1	1597	-	-
	10	871542	91.3	9	3	1961	1106	1001
3	Type 5	20	0.6	12	5.32			
	Burst ID	Burst Offset (μs)	Pulse Width (μs)	Chirp Width (MHz)	Number of Pulses per Burst	PRI-1 (μs)	PRI-2 (μs)	PRI-3 (μs)
	0	26541	68.1	19	2	1339	1355	-
	1	171821	58.7	19	1	1251	-	-
	2	316229	75.3	19	2	1136	1640	-
	3	461864	56.4	19	1	1753	-	-
	4	8677	99.7	19	3	1196	1708	1159
	5	153995	57.7	19	1	1013	-	-
	6	299238	59.5	19	1	1072	-	-
	7	443177	80	19	2	1482	1369	-
	8	587671	82	19	2	1993	1197	-
	9	135674	82.8	19	2	1883	1005	-
	10	279928	88	19	3	1061	1928	1101
	11	424279	93.2	19	3	1207	1907	1223
	12	570132	70.4	19	2	1526	1360	-
	13	117439	95.3	19	3	1171	1955	1775
	14	262502	81.9	19	2	1690	1545	-
	15	406573	98.5	19	3	1975	1169	1062
	16	553328	65	19	1	1767	-	-
	17	99799	85.4	19	3	1011	1637	1425
	18	244095	91.6	19	3	1878	1445	1325
	19	390012	67.3	19	2	1091	1218	-

Trial ID	Radar Type	Number of Bursts	Burst Period(s)	Wave from Length (s)	Center Frequency(GHz)	-		
4	Type 5	17	0.7058824	12	5.32			
	Burst ID	Burst Offset (μs)	Pulse Width (μs)	Chirp Width (MHz)	Number of Pulses per Burst	PRI-1 (μs)	PRI-2 (μs)	PRI-3 (μs)
	0	629614	67.9	16	2	1320	1133	-
	1	96856	62.3	16	1	1957	-	-
	2	267719	53.3	16	1	1592	-	-
	3	436784	90	16	3	1900	1153	1346
	4	608289	77.1	16	2	1166	1646	-
	5	75610	83.9	16	3	1278	1232	1459
	6	245638	89.1	16	3	1240	1384	1939
	7	416355	81.8	16	2	1833	1676	-
	8	588736	50.3	16	1	1075	-	-
	9	54571	87.1	16	3	1116	1996	1756
	10	225175	71.3	16	2	1225	1815	-
	11	394825	97.5	16	3	1884	1465	1132
	12	565361	90.6	16	3	1561	1040	1354
	13	33643	86.3	16	3	1596	1183	1792
	14	203957	97.6	16	3	1365	1073	1361
	15	373812	84.7	16	3	1021	1718	1854
	16	544060	99.7	16	3	1150	1244	1988
5	Type 5	14	0.8571429	12	5.32			
	Burst ID	Burst Offset (μs)	Pulse Width (μs)	Chirp Width (MHz)	Number of Pulses per Burst	PRI-1 (μs)	PRI-2 (μs)	PRI-3 (μs)
	0	15438	92.9	12	3	1085	1564	1407
	1	222486	67.7	12	2	1744	1747	-
	2	430731	65.8	12	1	1092	-	-
	3	637784	56.3	12	1	1851	-	-
	4	845342	53.7	12	1	1727	-	-
	5	196720	83.5	12	3	1679	1930	1025
	6	404955	65.8	12	1	1519	-	-
	7	610711	85.9	12	3	1134	1034	1808
	8	818057	76.3	12	2	1606	1926	-
	9	171459	81.5	12	2	1891	1714	-
	10	377969	89.4	12	3	1310	1594	1827
	11	586875	63.4	12	1	1568	-	-
	12	792834	69.6	12	2	1307	1925	-
	13	146044	74.5	12	2	1264	1846	-