

TEST REPORT

Applicant: Connected Solutions Group, LLC.
Address: 8529 Meadowbridge Rd. #300, Mechanicsville, Va 23116
Equipment Type: CSG m106 LTE Wireless Router
Model Name: CSG-m106
Brand Name: CSG
FCC ID: 2A5KA-M106
Test Standard: 47 CFR Part 15 Subpart C (refer section 3.1)
Test Date: Mar. 24, 2022 - Apr. 06, 2022
Date of Issue: May 25, 2022

ISSUED BY:

Shenzhen BALUN Technology Co., Ltd.

Tested by: Julie zhu

Checked by: Ye Hongji

Approved by: Liao Jianming
(Technical Director)

Julie zhu

Ye Hongji

Liao Jianming

Revision History		
Version	Issue Date	Revisions
<u>Rev. 01</u>	<u>May 25, 2022</u>	<u>Initial Issue</u>

TABLE OF CONTENTS

1	GENERAL INFORMATION	4
1.1	Identification of the Testing Laboratory	4
1.2	Identification of the Responsible Testing Location	4
2	PRODUCT INFORMATION	5
2.1	Applicant Information.....	5
2.2	Manufacturer Information	5
2.3	Factory Information	5
2.4	General Description for Equipment under Test (EUT)	5
2.5	Technical Information	6
2.6	Additional Instructions	8
3	SUMMARY OF TEST RESULTS.....	10
3.1	Test Standards	10
3.2	Test Verdict	10
4	GENERAL TEST CONFIGURATIONS.....	11
4.1	Test Environments	11
4.2	Test Equipment List.....	11
4.3	Test Software List.....	11
4.4	Measurement Uncertainty	12
4.5	Description of Test Setup	12
4.6	Measurement Results Explanation Example.....	15
5	TEST ITEMS.....	16
5.1	Antenna Requirements.....	16
5.2	Output Power	17
5.3	6dB Bandwidth	19

5.4	Conducted Spurious Emission	20
5.5	Band Edge (Authorized-band band-edge).....	22
5.6	Conducted Emission	24
5.7	Radiated Spurious Emission	25
5.8	Band Edge (Restricted-band band-edge).....	30
5.9	Power Spectral density (PSD).....	31
ANNEX A	TEST RESULT	32
A.1	Output Power	32
A.2	Bandwidth.....	40
A.3	Conducted Spurious Emissions	50
A.4	Band Edge (Authorized-band band-edge).....	77
A.5	Conducted Emissions.....	98
A.6	Radiated Emission	100
A.7	Band Edge (Restricted-band band-edge).....	120
A.8	Power Spectral Density (PSD)	132
ANNEX B	TEST SETUP PHOTOS	142
ANNEX C	EUT EXTERNAL PHOTOS.....	142
ANNEX D	EUT INTERNAL PHOTOS	142

1 GENERAL INFORMATION

1.1 Identification of the Testing Laboratory

Company Name	Shenzhen BALUN Technology Co., Ltd.
Address	Block B, 1/F, Baisha Science and Technology Park, Shahe West Road, Nanshan District, ShenZhen, GuangDong Province, China
Phone Number	+86 755 6685 0100

1.2 Identification of the Responsible Testing Location

Test Location	Shenzhen BALUN Technology Co., Ltd.
Address	Block B, 1/F, Baisha Science and Technology Park, Shahe West Road, Nanshan District, ShenZhen, GuangDong Province, China
Accreditation Certificate	The laboratory is a testing organization accredited by FCC as a accredited testing laboratory. The designation number is CN1196.
Description	All measurement facilities used to collect the measurement data are located at Block B, 1/F, Baisha Science and Technology Park, Shahe West Road, Nanshan District, ShenZhen, GuangDong Province, China

2 PRODUCT INFORMATION

2.1 Applicant Information

Applicant	Connected Solutions Group, LLC.
Address	8529 Meadowbridge Rd. #300, Mechanicsville, Va 23116

2.2 Manufacturer Information

Manufacturer	Connected Solutions Group, LLC.
Address	8529 Meadowbridge Rd. #300, Mechanicsville, Va 23116

2.3 Factory Information

Factory	N/A
Address	N/A

2.4 General Description for Equipment under Test (EUT)

EUT Name	CSG m106 LTE Wireless Router
Model Name Under Test	CSG-m106
Series Model Name	N/A
Description of Model name differentiation	N/A
Hardware Version	V1.2
Software Version	VB_3.211
Dimensions (Approx.)	N/A
Weight (Approx.)	N/A

2.5 Technical Information

Network and Wireless connectivity	3G Network WCDMA/HSDPA/HSUPA/HSPA+ Band 2/4/5 4G Network FDD LTE Band 2/4/5/7/8/12/13/25/26/30/66 WIFI 802.11b, 802.11g, 802.11n
-----------------------------------	--

The requirement for the following technical information of the EUT was tested in this report:

Frequency Range	802.11b/g/n(20 MHz): 2.412 GHz - 2.462 GHz $f_c = 2412 \text{ MHz} + (N-1)*5 \text{ MHz}$, where - f_c = "Operating Frequency" in MHz, - N = "Channel Number" with the range from 1 to 11. 802.11n(40 MHz): 2.422 GHz - 2.452 GHz $f_c = 2412 \text{ MHz} + (N-1)*5 \text{ MHz}$, where - f_c = "Operating Frequency" in MHz, - N = "Channel Number" with the range from 3 to 9.	
Modulation Type	DSSS, OFDM	
Product Type	<input type="checkbox"/> Mobile <input checked="" type="checkbox"/> Portable <input type="checkbox"/> Fix Location	
Antenna System (eg., MIMO, Smart Antenna)	Cyclic Delay Diversity (CDD) for 802.11b/g Multi Input Multi Output (MIMO) for 802.11n	
Categorization as Correlated or Completely Uncorrelated	Categorization as Correlated for 802.11b/g Categorization as Uncorrelated for 802.11n	
Antenna Type	Main Antenna Aux. Antenna	PCB Antenna
Antenna Gain	Main Antenna Aux. Antenna	3.0 dBi (In test items related to antenna gain, the final results reflect this figure. This value is provided by the applicant.)
Total directional gain	For power spectral density(PSD) measurements	Correlated: 6.0 dBi Formulas: Directional gain = $G_{ANT} + 10 \log(NANT)$ dBi Uncorrelated: 3.0 dBi Formulas: Directional gain = G_{ANT}
	For power measurements	Correlated: 6.0 dBi Formulas: Directional gain = $G_{ANT} + 10 \log(NANT)$ dBi Uncorrelated: 3.0 dBi Formulas: Directional gain = G_{ANT}
	For Conducted Out-of-Band and Spurious Measurement	Correlated: 6.0 dBi Formulas: Directional gain = $G_{ANT} + 10 \log(NANT)$ dBi Uncorrelated: 3.0 dBi

	s	Formulas: Directional gain = $GANT$
About the Product		Only the WIFI 802.11b, 802.11g and 802.11n (HT20/40) was tested in this report.

Mode	Antenna		
	Main Antenna	Aux. Antenna	MIMO
802.11b	√	√	--
802.11g	√	√	--
802.11n20	√	√	√
802.11n40	√	√	√

Note: All the configurations were tested, but only the worst data was shown in this report.

Modulation technology	Modulation Type	Transfer Rate (Mbps)(Single RF path)
DSSS (802.11b)	DBPSK	1
	DQPSK	2
	CCK	5.5/11
OFDM (802.11g)	BPSK	6/9
	QPSK	12/18
	16QAM	24/36
	64QAM	48/54
OFDM (802.11n-20 MHz)	BPSK	6.5/7.2
	QPSK	13/19.5/14.4/21.7
	16QAM	26/39/28.9/43.3
	64QAM	52/58.5/65/57.8/65/72.2
OFDM (802.11n-40 MHz)	BPSK	13.5/15
	QPSK	27/40.5/30/45
	16QAM	54/81/60/90
	64QAM	108/121.5/135/120/150

Note: Preliminary tests were performed in different data rate in above table to find the worst radiated emission. The data rate shown in the table below is the worst-case rate with respect to the specific test item. Investigation has been done on all the possible configurations for searching the worst cases. The following table is a list of the test modes shown in this test report.

Test Items	Mode	Data Rate	Channel	
Output Power	11b/11g/11n20/11n40	1/6/6.5/13.5 Mbps	1/6/11	3/6/9
6dB Bandwidth	11b/11g/11n20/11n40	1/6/6.5/13.5 Mbps	1/6/11	3/6/9
Conducted Spurious Emission	11b/11g/11n20/11n40	1/6/6.5/13.5 Mbps	1/6/11	3/6/9
Conducted Emission	11b/11g/11n20/11n40	1/6/6.5/13.5 Mbps	1/6/11	3/6/9
Radiated Spurious Emission	11b/11g/11n20/11n40	1/6/6.5/13.5 Mbps	1/6/11	3/6/9
Band Edge	11b/11g/11n20/11n40	1/6/6.5/13.5 Mbps	1/6/11	3/6/9
Power spectral density (PSD)	11b/11g/11n20/11n40	1/6/6.5/13.5 Mbps	1/6/11	3/6/9

Note: The above EUT information in section 2.4 and 2.6 was declared by manufacturer and for more detailed features description, please refer to the manufacturer's specifications or user's manual.

2.6 Additional Instructions

EUT Software Settings:

Mode	<input checked="" type="checkbox"/> Special software is used. The software provided by client to enable the EUT under transmission condition continuously at specific channel frequencies individually.
------	--

During testing, Channel and Power Controlling Software provided by the customer was used to control the operating channel as well as the output power level. The RF output power selection is for the setting of RF output power expected by the customer and is going to be fixed on the firmware of the final end product.

Power level setup in software						
Test Software Version	cart.exe					
Support Units (Software installation media)	Description		Manufacturer		Model	
	Notebook		HP		N/A	
Mode	Channel	Frequency (MHz)	Soft Set			
			Main Antenna	Aux. Antenna	MIMO-Main Antenna	MIMO-Aux. Antenna
802.11b	1	2412	14.0	14.0	--	--
	6	2437	15.5	15.5	--	--
	11	2462	14.0	14.0	--	--
802.11g	1	2412	14.0	14.0	--	--
	6	2437	19.5	19.0	--	--
	11	2462	15.0	15.0	--	--
802.11n20	1	2412	13.5	13.5	13.0	13.0
	6	2437	19.5	19.0	19.0	19.5
	11	2462	14.0	14.0	12.5	12.5
802.11n40	3	2422	11.5	11.5	10.0	10.0
	6	2437	19.5	19.5	19.0	19.5
	9	2452	10.5	10.5	10.0	10.0

Run software:

```
D:\0WA30807\测试资料\定频软件及操作说明\art2_ver_4_9_853_xe300\bin\cart.exe
5001 INFO Connected to nart[0] on 192.168.1.1:2390.
[0] 5109 INFO Accepted control connection from client 0.
[0] 6606 INFO Link control functions loaded for "Link" from "//liblinkAr9k.so".
[0] 6506 INFO Device control functions loaded for "Ar9287" from "//libar9287.so". Version "4.0" built on "110602124500".

[0] 6501 WARNING Unable to find device dll "ar946x".
[0] 6501 WARNING Unable to find device dll "ar956x".
[0] 6501 WARNING Unable to find device dll "AR9485".
[0] 6606 INFO Link control functions loaded for "Link" from "//liblinkAr9k.so".
[0] 6506 INFO Device control functions loaded for "Ar9300" from "//libar9300.so". Version "4.5.3" built on "120510170000".

[0] 6011 INFO Calibration information read from flash.
[0] 6024 INFO Free memory for initialization and calibration is 511 (1023 - 512) bytes.
[0] 6000 INFO Loaded card.
7000 INFO Command file "auto.art" completed at 356558593. Elapsed time was 1687 ms.
7000 INFO Command file "start.art" completed at 356558593. Elapsed time was 3484 ms.
7172 INFO Initialization complete. Waiting for commands.
connect 192.168.1.1
5007 ERROR Closed connection to nart[0].
5000 INFO Trying to connect to nart[0] on 192.168.1.1:2390.
5001 INFO Connected to nart[0] on 192.168.1.1:2390.
load
[0] 5109 INFO Accepted control connection from client 1.
[0] 6024 INFO Free memory for initialization and calibration is 511 (1023 - 512) bytes.
[0] 6000 INFO Loaded card.
tx ir=0;gi=0;pc=-1;pl=1500;bc=1;retry=0;att=0;stat=3;dur=-1;dump=0;pro=0;deaf=0;reset=-1;agg=0;ht40=0;ifs=1;r=11;tp=14;f
=2412;txch=1;
2004 WARNING Transmit forever requires rate interleaving. pc<0 => ir=1.
2008 ERROR No attenuators.
```

3 SUMMARY OF TEST RESULTS

3.1 Test Standards

No.	Identity	Document Title
1	47 CFR Part 15, Subpart C	Miscellaneous Wireless Communications Services
2	KDB Publication 662911 D01v02r01	Emissions Testing of Transmitters with Multiple Outputs in the Same Band (e.g., MIMO, Smart Antenna, etc)
3	ANSI C63.10-2013	American National Standard of Procedures for Compliance Testing of Unlicensed Wireless Devices
4	KDB Publication 558074 D01v05r02	GUIDANCE FOR COMPLIANCE MEASUREMENTS ON DIGITAL TRANSMISSION SYSTEM, FREQUENCY HOPPING SPREAD SPECTRUM SYSTEM, AND HYBRID SYSTEM DEVICES OPERATING UNDER SECTION 15.247 OF THE FCC RULES

3.2 Test Verdict

No.	Description	FCC PART No.	Test Result	Verdict
1	Antenna Requirement	15.203	N/A	Pass ^{Note 1}
2	Output Power	15.247 (b)	ANNEX A.1	Pass
3	6dB Bandwidth	15.247 (a)	ANNEX A.2	Pass
4	Conducted Spurious Emission	15.247 (d)	ANNEX A.3	Pass
5	Band Edge(Authorized-band band-edge)	15.247 (d)	ANNEX A.4	Pass
6	Conducted Emission	15.207	ANNEX A.5	Pass
7	Radiated Spurious Emission	15.209; 15.247 (d)	ANNEX A.6	Pass
8	Band Edge(Restricted-band band-edge)	15.209; 15.247 (d)	ANNEX A.7	Pass
9	Power spectral density (PSD)	15.247 (e)	ANNEX A.8	Pass
10	Receiver Spurious Emissions	N/A	N/A	N/A ^{Note 2}

Note 1: Please refer to section 5.1.

Note 2: Only radio communication receivers operating in stand-alone mode within the band 30-960 MHz, as well as scanner receivers, are subject to Industry Canada requirements, so this test is not applicable.

4 GENERAL TEST CONFIGURATIONS

4.1 Test Environments

During the measurement, the normal environmental conditions were within the listed ranges:

Relative Humidity	45% to 55%	
Atmospheric Pressure	100 kPa to 102 kPa	
Temperature	NT (Normal Temperature)	+22°C to +25°C
Working Voltage of the EUT	NV (Normal Voltage)	3.7 V

4.2 Test Equipment List

Description	Manufacturer	Model	Serial No.	Cal. Date	Cal. Due
Spectrum Analyzer	ROHDE&SCHWARZ	FSV-40	101544	2022.01.04	2023.01.03
Spectrum Analyzer	KEYSIGHT	N9020A	MY50330200	2021.06.01	2022.05.31
Signaling Unit	ROHDE&SCHWARZ	CMW500	142028	2021.06.01	2022.05.31
EMI Receiver	KEYSIGHT	N9038A	MY53220118	2021.09.13	2022.09.12
EMI Receiver	ROHDE&SCHWARZ	ESRP	101036	2021.10.10	2022.10.09
LISN	SCHWARZBECK	NSLK 8127	8127-687	2021.06.08	2022.06.07
Test Antenna- Loop(9 kHz-30 MHz)	SCHWARZBECK	FMZB 1519	1519-037	2021.04.16	2024.04.15
Test Antenna- Bi-Log(30 MHz-3 GHz)	SCHWARZBECK	VULB 9163	9163-624	2021.08.20	2024.08.19
Test Antenna- Horn(1-18 GHz)	SCHWARZBECK	BBHA 9120D	9120D-1917	2019.07.02	2022.07.01
Test Antenna- Horn (18-40 GHz)	A-INFO	LB- 180400KF	J211060273	2021.07.02	2024.07.01
Anechoic Chamber	RAINFORD	9m*6m*6m	N/A	2021.09.04	2024.09.09
Anechoic Chamber	EMC Electronic Co., Ltd	20.10*11.60 *7.35m	N/A	2021.08.15	2024.08.14
Shielded Enclosure	ChangNing	CN-130701	130703	--	--
Power Sensor	KEYSIGHT	U2063XA	MY58000247	2021.09.13	2022.09.12

4.3 Test Software List

Description	Manufacturer	Software Version	Serial No.	Applicable test Setup
BL410R	BALUN	V2.1.1.488	N/A	The section 4.5.1
BL410E	BALUN	V19.8.28.435	N/A	The section 4.5.2&4.5.3&4.5.4&4.5.5

4.4 Measurement Uncertainty

The following measurement uncertainty levels have been estimated for tests performed on the EUT as specified in CISPR 16-4-2.

This uncertainty represents an expanded uncertainty expressed at approximately the 95% confidence level using a coverage factor of k=2.

Parameters	Uncertainty
Occupied Channel Bandwidth	2.8%
RF output power, conducted	1.28 dB
Power Spectral Density, conducted	1.30 dB
Unwanted Emissions, conducted	1.84 dB
All emissions, radiated	5.36 dB
Temperature	0.82°C
Humidity	4.1%

4.5 Description of Test Setup

4.5.1 For Antenna Port Test

$$\text{Conducted value (dBm)} = \text{Measurement value (dBm)} + \text{cable loss (dB)}$$

For example: the measurement value is 10 dBm and the cable 0.5dBm used, then the final result of EUT:

$$\text{Conducted value (dBm)} = 10 \text{ dBm} + 0.5 \text{ dB} = 10.5 \text{ dBm}$$

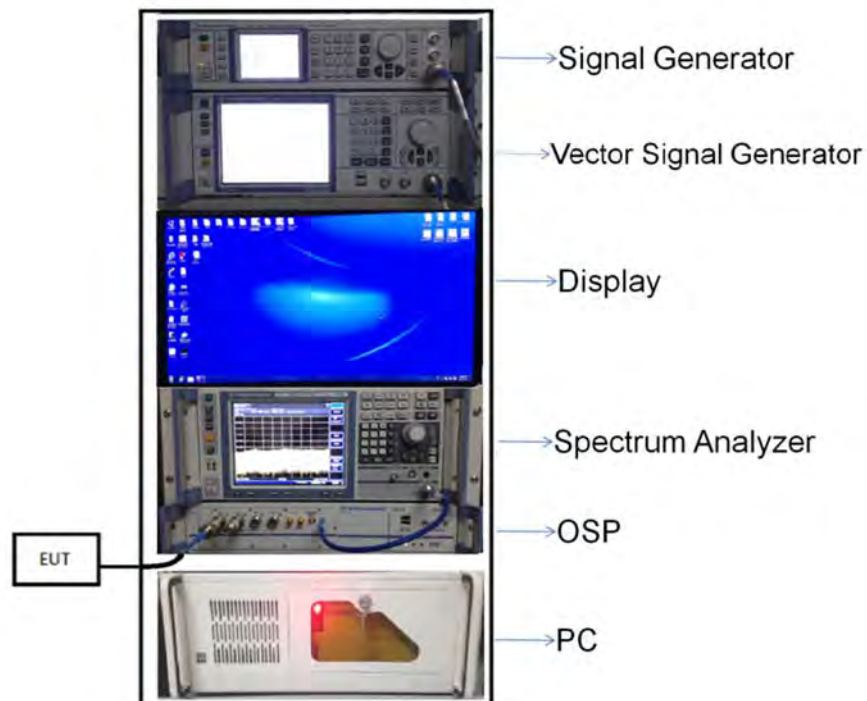

(Diagram 1)

4.5.2 For AC Power Supply Port Test

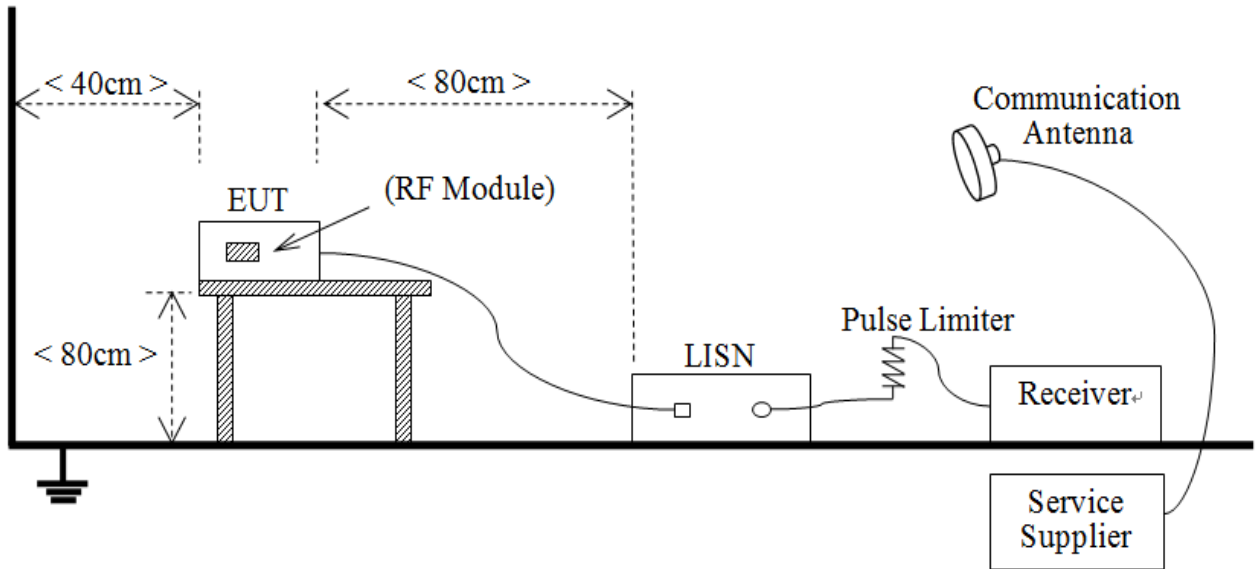

(Diagram 2)

4.5.3 For Radiated Test (Below 30 MHz)

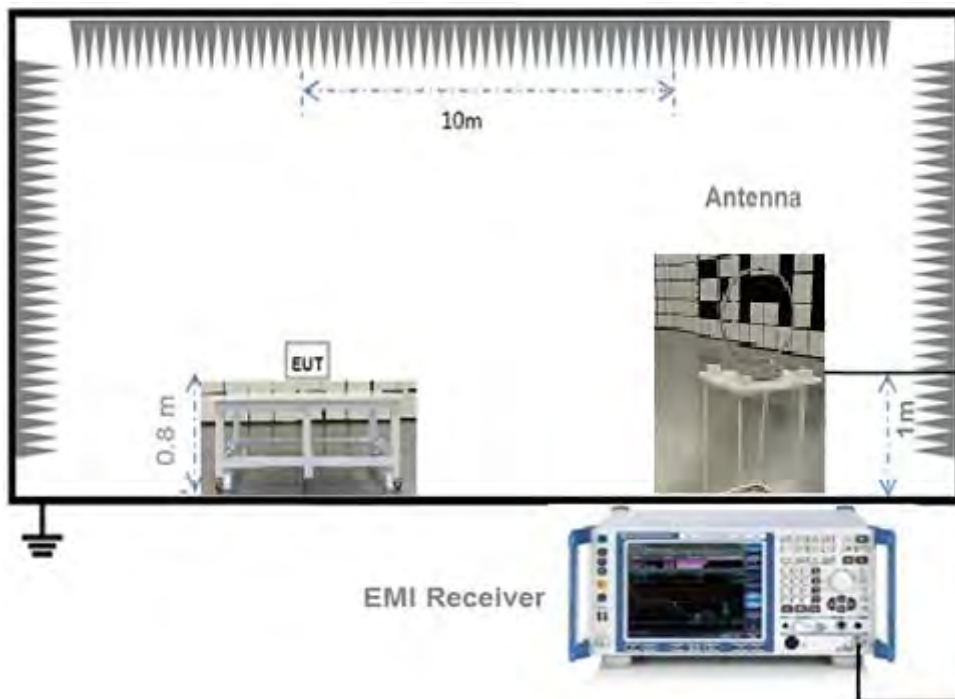

(Diagram 3)

4.5.4 For Radiated Test (30 MHz-1 GHz)

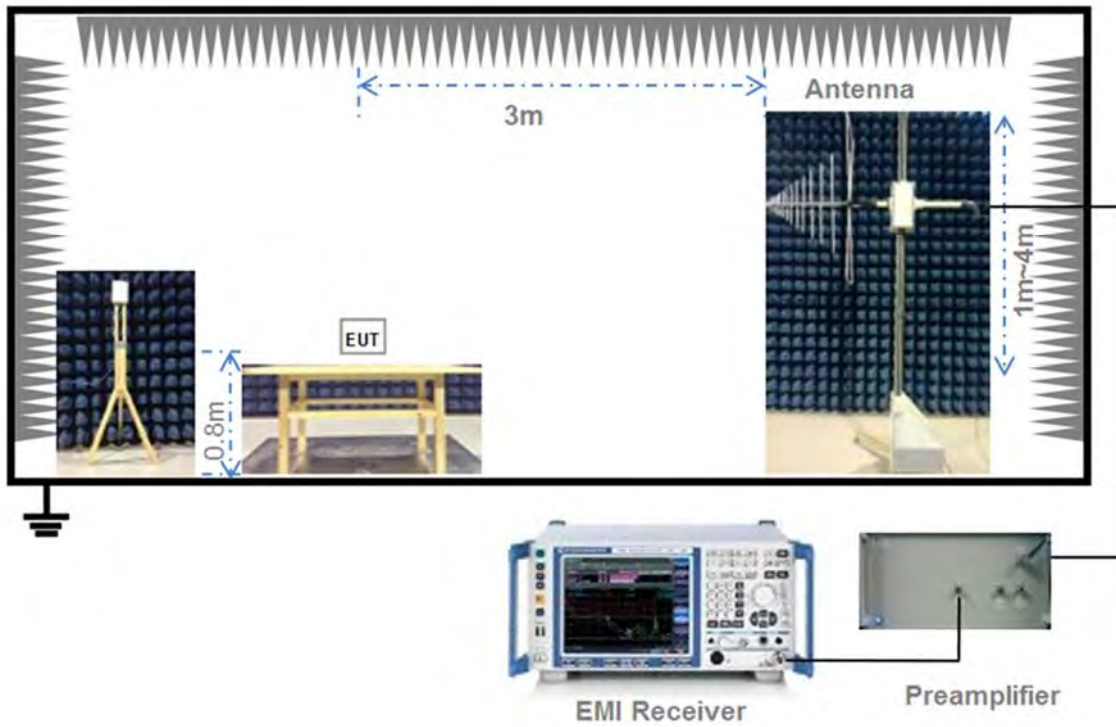

(Diagram 4)

4.5.5 For Radiated Test (Above 1 GHz)

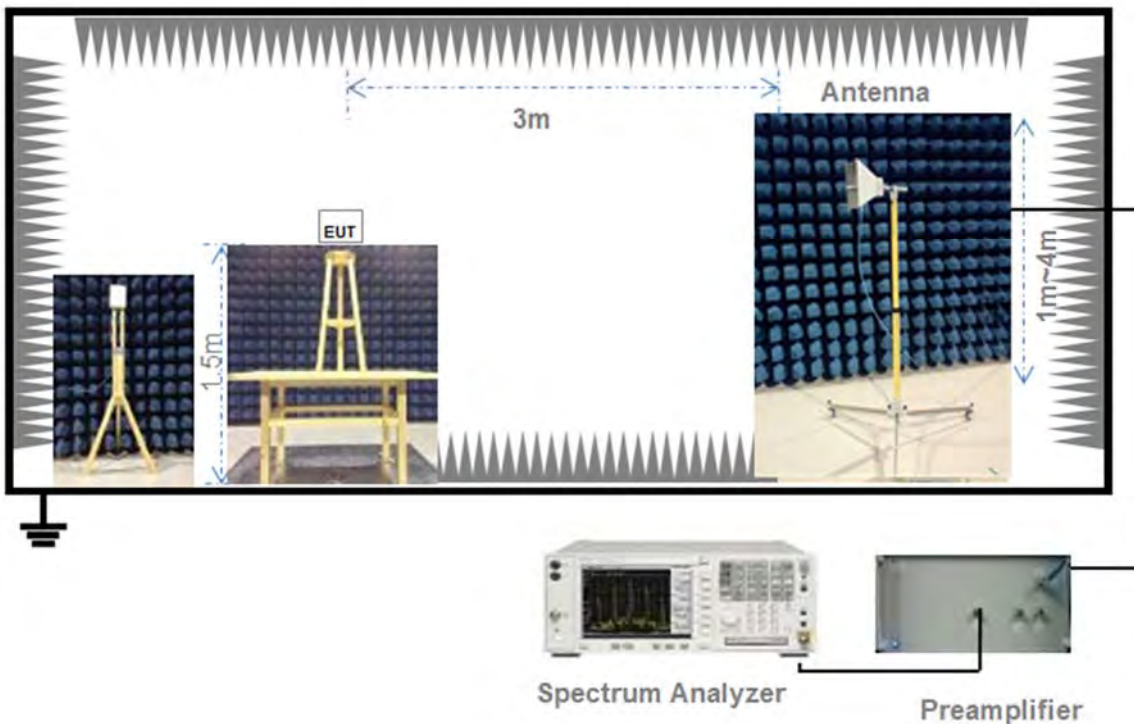

(Diagram 5)

4.6 Measurement Results Explanation Example

4.6.1 For conducted test items:

The offset level is set in the spectrum analyzer to compensate the RF cable loss and attenuator between EUT conducted output port and spectrum analyzer. With the offset compensation, the spectrum analyzer reading level is exactly the EUT RF output level.

The spectrum analyzer offset is derived from RF cable loss and attenuator factor.

Offset = RF cable loss + attenuator factor.

4.6.2 For radiated band edges and spurious emission test:

$$E = \text{EIRP} - 20 \log D + 104.8$$

where:

E = electric field strength in dB μ V/m,

EIRP = equivalent isotropic radiated power in dBm

D = specified measurement distance in meters.

EIRP = Measure Conducted output power Value (dBm) + Maximum transmit antenna gain (dBi) + the appropriate maximum ground reflection factor (dB)

5 TEST ITEMS

5.1 Antenna Requirements

5.1.1 Relevant Standards

FCC §15.203

An intentional radiator shall be designed to ensure that no antenna other than that furnished by the responsible party shall be used with the device. The use of a permanently attached antenna or of an antenna that uses a unique coupling to the intentional radiator shall be considered sufficient to comply with the provisions of this section. The manufacturer may design the unit so that a broken antenna can be replaced by the user, but the use of a standard antenna jack or electrical connector is prohibited. This requirement does not apply to carrier current devices or to devices operated under the provisions of § 15.211, § 15.213, § 15.217, § 15.219, or § 15.221. Further, this requirement does not apply to intentional radiators that must be professionally installed, such as perimeter protection systems and some field disturbance sensors, or to other intentional radiators which, in accordance with § 15.31(d), must be measured at the installation site. However, the installer shall be responsible for ensuring that the proper antenna is employed so that the limits in this part are not exceeded.

If directional gain of transmitting antennas is greater than 6 dBi, the power shall be reduced by the same level in dB comparing to gain minus 6 dBi. For the fixed point-to-point operation, the power shall be reduced by one dB for every 3 dB that the directional gain of the antenna exceeds 6 dBi. The use of a permanently attached antenna or of an antenna that uses a unique coupling to the intentional radiator shall be considered sufficient to comply with the FCC rule.

5.1.2 Antenna Anti-Replacement Construction

The Antenna Anti-Replacement as following method:

Protected Method	Description
The antenna is embedded in the product.	An embedded-in antenna design is used.

Reference Documents	Item
Photo	Please refer to the EUT Photo documents.

5.1.3 Antenna Gain

The antenna peak gain of EUT is less than 6 dBi. Therefore, it is not necessary to reduce maximum peak output power limit.

5.2 Output Power

5.2.1 Test Limit

FCC § 15.247(b)

For systems using digital modulation in the 902-928 MHz, 2400-2483.5 MHz, and 5725-5850 MHz bands: 1 Watt. As an alternative to a peak power measurement, compliance with the one Watt limit can be based on a measurement of the maximum conducted output power. Maximum Conducted Output Power is defined as the total transmit power delivered to all antennas and antenna elements averaged across all symbols in the signaling alphabet when the transmitter is operating at its maximum power control level. Power must be summed across all antennas and antenna elements.

5.2.2 Test Setup

See section 4.5.1 for test setup description for the antenna port. The photo of test setup please refer to ANNEX B.

5.2.3 Test Procedure

Maximum peak conducted output power

The maximum peak conducted output power may be measured using a broadband peak RF power meter. The power meter shall have a video bandwidth that is greater than or equal to the DTS bandwidth and shall utilize a fast-responding diode detector.

Maximum conducted (average) output power (Reporting Only)

a) As an alternative to spectrum analyzer or EMI receiver measurements, measurements may be performed

using a wideband RF power meter with a thermocouple detector or equivalent if all of the conditions listed below are satisfied.

- 1) The EUT is configured to transmit continuously, or to transmit with a constant duty factor.
- 2) At all times when the EUT is transmitting, it shall be transmitting at its maximum power control level.
- 3) The integration period of the power meter exceeds the repetition period of the transmitted signal by at least a factor of five.

b) If the transmitter does not transmit continuously, measure the duty cycle (x) of the transmitter output signal as

described in Section 6.0.

c) Measure the average power of the transmitter. This measurement is an average over both the on and off periods of the transmitter.

d) Adjust the measurement in dBm by adding $10\log(1/x)$, where x is the duty cycle to the measurement result.

Measurements of duty cycle

The zero-span mode on a spectrum analyzer or EMI receiver if the response time and spacing between bins on the sweep are sufficient to permit accurate measurements of the on and off times of the transmitted signal.

Set the center frequency of the instrument to the center frequency of the transmission.

Set $RBW \geq OBW$ if possible; otherwise, set RBW to the largest available value.

Set $VBW \geq RBW$. Set detector = peak or average.

The zero-span measurement method shall not be used unless both RBW and VBW are $> 50/T$ and the number of sweep points across duration T exceeds 100. (For example, if VBW and/or RBW are limited to 3 MHz, then the zero-span method of measuring duty cycle shall not be used if $T \leq 16.7$ microseconds.)

5.2.4 Test Result

Please refer to ANNEX A.1.

5.3 6dB Bandwidth

5.3.1 Limit

FCC §15.247(a)

Make the measurement with the spectrum analyzer's resolution bandwidth (RBW) = 100 kHz. In order to make an accurate measurement, set the span greater than RBW. The 6 dB bandwidth must be greater than 500 kHz.

5.3.2 Test Setup

See section 4.5.1 for test setup description for the antenna port. The photo of test setup please refer to ANNEX B.

5.3.3 Test Procedure

Use the following spectrum analyzer settings:

Set RBW = 100 kHz.

Set the video bandwidth (VBW) \geq 3 RBW.

Detector = Peak.

Trace mode = max hold.

Sweep = auto couple.

Allow the trace to stabilize.

Measure the maximum width of the emission that is constrained by the frequencies associated with the two outermost amplitude points (upper and lower frequencies) that are attenuated by 6 dB relative to the maximum level measured in the fundamental emission.

5.3.4 Test Result

Please refer to ANNEX A.2.

5.4 Conducted Spurious Emission

5.4.1 Limit

FCC §15.247(d)

In any 100 kHz bandwidth outside the frequency band in which the spread spectrum or digitally modulated intentional radiator is operating, the radio frequency power that is produced by the intentional radiator shall be at least 20 dB below that in the 100 kHz bandwidth within the band that contains the highest level of the desired power, based on either an RF conducted or a radiated measurement.

5.4.2 Test Setup

See section 4.5.1 for test setup description for the antenna port. The photo of test setup please refer to ANNEX B.

5.4.3 Test Procedure

The DTS rules specify that in any 100 kHz bandwidth outside of the authorized frequency band, the power shall be attenuated according to the following conditions:

- a) If the maximum peak conducted output power procedure was used to demonstrate compliance as described in 9.1, then the peak output power measured in any 100 kHz bandwidth outside of the authorized frequency band shall be attenuated by at least 20 dB relative to the maximum in-band peak PSD level in 100 kHz (i.e., 20 dBc).
- b) If maximum conducted (average) output power was used to demonstrate compliance as described in 9.2, then the peak power in any 100 kHz bandwidth outside of the authorized frequency band shall be attenuated by at least 30 dB relative to the maximum in-band peak PSD level in 100 kHz (i.e., 30 dBc).
- c) In either case, attenuation to levels below the 15.209 general radiated emissions limits is not required.

The following procedures shall be used to demonstrate compliance to these limits. Note that these procedures can be used in either an antenna-port conducted or radiated test set-up. Radiated tests must conform to the test site requirements and utilize maximization procedures defined herein.

Reference level measurement

Establish a reference level by using the following procedure:

Set instrument center frequency to DTS channel center frequency.

Set the span to ≥ 1.5 times the DTS bandwidth.

Set the RBW = 100 kHz.

Set the VBW $\geq 3 \times$ RBW.

Detector = peak.

Sweep time = auto couple.

Trace mode = max hold.

Allow trace to fully stabilize.

Use the peak marker function to determine the maximum PSD level.

Emission level measurement

Use the following spectrum analyzer settings:

Span = wide enough to capture the peak level of the in-band emission and all spurious emissions (e.g., harmonics) from the lowest frequency generated in the EUT up through the 10th harmonic. Typically, several plots are required to cover this entire span.

Set the RBW = 100 kHz.

Set the VBW $\geq 3 \times$ RBW.

Detector = peak.

Sweep time = auto couple.

Trace mode = max hold.

Allow trace to fully stabilize.

Use the peak marker function to determine the maximum amplitude level.

Ensure that the amplitude of all unwanted emissions outside of the authorized frequency band (excluding restricted frequency bands) are attenuated by at least the minimum requirements specified in 11.1 a) or 11.1 b). Report the three highest emissions relative to the limit.

5.4.4 Test Result

Please refer to ANNEX A.3.

5.5 Band Edge (Authorized-band band-edge)

5.5.1 Limit

FCC §15.247(d)

In any 100 kHz bandwidth outside the frequency band in which the spread spectrum or digitally modulated intentional radiator is operating, the radio frequency power that is produced by the intentional radiator shall be at least 20 dB below that in the 100 kHz bandwidth within the band that contains the highest level of the desired power, based on either an RF conducted or a radiated measurement.

5.5.2 Test Setup

See section 4.5.1 for test setup description for the antenna port. The photo of test setup please refer to ANNEX B.

5.5.3 Test Procedure

The following procedures may be used to determine the peak or average field strength or power of an unwanted emission that is within 2 MHz of the authorized band edge. If a peak detector is utilized, use the procedure described in 13.2.1. Use the procedure described in 13.2.2 when using an average detector and the EUT can be configured to transmit continuously (i.e., duty cycle $\geq 98\%$). Use the procedure described in 13.2.3 when using an average detector and the EUT cannot be configured to transmit continuously but the duty cycle is constant (i.e., duty cycle variations are less than ± 2 percent). Use the procedure described in 13.2.4 when using an average detector for those cases where the EUT cannot be configured to transmit continuously and the duty cycle is not constant (duty cycle variations equal or exceed 2 percent).

When using a peak detector to measure unwanted emissions at or near the band edge (within 2 MHz of the authorized band), the following integration procedure can be used.

Set instrument center frequency to the frequency of the emission to be measured (must be within 2 MHz of the authorized band edge).

Set span to 2 MHz

RBW = 100 kHz.

VBW $\geq 3 \times$ RBW.

Detector = peak.

Sweep time = auto.

Trace mode = max hold.

Allow sweep to continue until the trace stabilizes (required measurement time may increase for low duty cycle applications)

Compute the power by integrating the spectrum over 1 MHz using the analyzer's band power measurement function with band limits set equal to the emission frequency (femission) ± 0.5 MHz. If the instrument does not have a band power function, then sum the amplitude levels (in power units) at 100 kHz intervals extending across the 1 MHz spectrum defined by femission ± 0.5 MHz.

Standard method(The 99% OBW of the fundamental emission is without 2 MHz of the authorized band):

Span: Wide enough to capture the peak level of the emission operating on the channel closest to the band edge, as well as any modulation products that fall outside of the authorized band of operation.

Reference level: As required to keep the signal from exceeding the maximum instrument input mixer level for linear operation. In general, the peak of the spectral envelope shall be more than [10 log (OBW/RBW)] below the reference level. Specific guidance is given in 4.1.5.2.

Attenuation: Auto (at least 10 dB preferred).

Sweep time: Coupled.

Resolution bandwidth: 100 kHz.

Video bandwidth: 300 kHz.

Detector: Peak.

Trace: Max hold.

5.5.4 Test Result

Please refer to ANNEX A.4.

5.6 Conducted Emission

5.6.1 Limit

FCC §15.207

For an intentional radiator that is designed to be connected to the public utility (AC) power line, the radio frequency voltage that is conducted back onto the AC power line on any frequency within the band 150 kHz to 30 MHz shall not exceed the limits in the following table, as measured using a 50 μ H/50 Ω line impedance stabilization network (LISN).

Frequency range (MHz)	Conducted Limit (dB μ V)	
	Quai-peak	Average
0.15 - 0.50	66 to 56	56 to 46
0.50 - 5	56	46
0.50 - 30	60	50

5.6.2 Test Setup

See section 4.5.2 for test setup description for the AC power supply port. The photo of test setup please refer to ANNEX B.

5.6.3 Test Procedure

The maximum conducted interference is searched using Peak (PK), if the emission levels more than the AV and QP limits, and that have narrow margins from the AV and QP limits will be re-measured with AV and QP detectors. Tests for both L phase and N phase lines of the power mains connected to the EUT are performed. Refer to recorded points and plots below.

Devices subject to Part 15 must be tested for all available U.S. voltages and frequencies (such as a nominal 120 VAC, 50/60 Hz and 240 VAC, 50/60 Hz) for which the device is capable of operation. A device rated for 50/60 Hz operation need not be tested at both frequencies provided the radiated and line conducted emissions are the same at both frequencies.

5.6.4 Test Result

Please refer to ANNEX A.5.

5.7 Radiated Spurious Emission

5.7.1 Limit

FCC §15.209&15.247(d)

Radiated emission outside the frequency band attenuation below the general limits specified in FCC section 15.209(a) is not required. In addition, radiated emissions which fall in the restricted bands, as defined in FCC section 15.205(a), must also comply with the radiated emission limits specified in FCC section 15.209(a).

According to FCC section 15.209 (a), except as provided elsewhere in this subpart, the emissions from an intentional radiator shall not exceed the field strength levels specified in the following table:

Frequency (MHz)	Field Strength ($\mu\text{V}/\text{m}$)	Measurement Distance (m)
0.009 - 0.490	2400/F(kHz)	300
0.490 - 1.705	24000/F(kHz)	30
1.705 - 30.0	30	30
30 - 88	100	3
88 - 216	150	3
216 - 960	200	3
Above 960	500	3

Note:

1. For Above 1000 MHz, the emission limit in this paragraph is based on measurement instrumentation employing an average detector, measurement using instrumentation with a peak detector function, corresponding to 20dB above the maximum permitted average limit.
2. For above 1000 MHz, limit field strength of harmonics: 54dBuV/m@3m (AV) and 74dBuV/m@3m (PK).

5.7.2 Test Setup

See section 4.5.3 to 4.5.5 for test setup description for the antenna port. The photo of test setup please refer to ANNEX B.

5.7.3 Test Procedure

Since the emission limits are specified in terms of radiated field strength levels, measurements performed to demonstrate compliance have traditionally relied on a radiated test configuration. Radiated measurements remain the principal method for demonstrating compliance to the specified limits; however antenna-port conducted measurements are also now acceptable to demonstrate compliance (see below for details). When radiated measurements are utilized, test site requirements and procedures for maximizing and measuring radiated emissions that are described in ANSI C63.10 shall be followed.

Antenna-port conducted measurements may also be used as an alternative to radiated measurements for demonstrating compliance in the restricted frequency bands. If conducted measurements are performed, then proper impedance matching must be ensured and an additional radiated test for cabinet/case spurious emissions is required.

General Procedure for conducted measurements in restricted bands

- a) Measure the conducted output power (in dBm) using the detector specified (see guidance regarding measurement procedures for determining quasi-peak, peak, and average conducted output power, respectively).
- b) Add the maximum transmit antenna gain (in dBi) to the measured output power level to determine the EIRP level (see guidance on determining the applicable antenna gain)
- c) Add the appropriate maximum ground reflection factor to the EIRP level (6 dB for frequencies ≤ 30 MHz, 4.7 dB for frequencies between 30 MHz and 1000 MHz, inclusive and 0 dB for frequencies > 1000 MHz).
- d) For devices with multiple antenna-ports, measure the power of each individual chain and sum the EIRP of all chains in linear terms (e.g., Watts, mW).
- e) Convert the resultant EIRP level to an equivalent electric field strength using the following relationship:

$$E = \text{EIRP} - 20\log D + 104.8$$

where:

E = electric field strength in dB μ V/m,

EIRP = equivalent isotropic radiated power in dBm

D = specified measurement distance in meters.

- f) Compare the resultant electric field strength level to the applicable limit.
- g) Perform radiated spurious emission test.

Quasi-Peak measurement procedure

The specifications for measurements using the CISPR quasi-peak detector can be found in Publication 16 of the International Special Committee on Radio Frequency Interference (CISPR) of the International Electrotechnical Commission.

As an alternative to CISPR quasi-peak measurement, compliance can be demonstrated to the applicable emission limits using a peak detector.

Peak power measurement procedure

Peak emission levels are measured by setting the instrument as follows:

- a) RBW = as specified in Table 1.
- b) VBW $\geq 3 \times$ RBW.
- c) Detector = Peak.
- d) Sweep time = auto.
- e) Trace mode = max hold.
- f) Allow sweeps to continue until the trace stabilizes. (Note that the required measurement time may be

longer for low duty cycle applications).

Table 1—RBW as a function of frequency

Frequency	RBW
9-150 kHz	200-300 Hz
0.15-30 MHz	9-10 kHz
30-1000 MHz	100-120 kHz
> 1000 MHz	1 MHz

If the peak-detected amplitude can be shown to comply with the average limit, then it is not necessary to perform a separate average measurement.

Trace averaging across on and off times of the EUT transmissions followed by duty cycle correction

If continuous transmission of the EUT (i.e., duty cycle ≥ 98 percent) cannot be achieved and the duty cycle is constant (i.e., duty cycle variations are less than ± 2 percent), then the following procedure shall be used:

- a) The EUT shall be configured to operate at the maximum achievable duty cycle.
- b) Measure the duty cycle, x , of the transmitter output signal as described in section 6.0.
- c) RBW = 1 MHz (unless otherwise specified).
- d) VBW $\geq 3 \times$ RBW.
- e) Detector = RMS, if $\text{span}/(\# \text{ of points in sweep}) \leq (\text{RBW}/2)$. Satisfying this condition may require increasing the number of points in the sweep or reducing the span. If this condition cannot be satisfied, then the detector mode shall be set to peak.
- f) Averaging type = power (i.e., RMS).
 - 1) As an alternative, the detector and averaging type may be set for linear voltage averaging.
 - 2) Some instruments require linear display mode in order to use linear voltage averaging. Log or dB averaging shall not be used.
- g) Sweep time = auto.
- h) Perform a trace average of at least 100 traces.
- i) A correction factor shall be added to the measurement results prior to comparing to the emission limit in order to compute the emission level that would have been measured had the test been performed at 100 percent duty cycle. The correction factor is computed as follows:
 - 1) If power averaging (RMS) mode was used in step f), then the applicable correction factor is $10 \log(1/x)$, where x is the duty cycle.
 - 2) If linear voltage averaging mode was used in step f), then the applicable correction factor is $20 \log(1/x)$, where x is the duty cycle.
 - 3) If a specific emission is demonstrated to be continuous (≥ 98 percent duty cycle) rather than turning on and off with the transmit cycle, then no duty cycle correction is required for that emission.

NOTE: Reduction of the measured emission amplitude levels to account for operational duty factor is not permitted. Compliance is based on emission levels occurring during transmission - not on an average across on and off times of the transmitter.

Determining the applicable transmit antenna gain

A conducted power measurement will determine the maximum output power associated with a restricted band emission; however, in order to determine the associated EIRP level, the gain of the transmitting antenna (in dBi) must be added to the measured output power (in dBm).

Since the out-of-band characteristics of the EUT transmit antenna will often be unknown, the use of a conservative antenna gain value is necessary. Thus, when determining the EIRP based on the measured conducted power, the upper bound on antenna gain for a device with a single RF output shall be selected as the maximum in-band gain of the antenna across all operating bands, or 2 dBi, whichever is greater. However, for devices that operate in multiple frequency bands while using the same transmit antenna, the highest gain of the antenna within the operating band nearest in frequency to the restricted band emission being measured may be used in lieu of the overall highest gain when the emission is at a frequency that is within 20 percent of the nearest band edge frequency, but in no case shall a value less than 2 dBi be used.

See KDB 662911 for guidance on calculating the additional array gain term when determining the effective antenna gain for a EUT with multiple outputs occupying the same or overlapping frequency ranges in the same band.

Radiated spurious emission test

An additional consideration when performing conducted measurements of restricted band emissions is that unwanted emissions radiating from the EUT cabinet, control circuits, power leads, or intermediate circuit elements will likely go undetected in a conducted measurement configuration. To address this concern, a radiated test shall be performed to ensure that emissions emanating from the EUT cabinet (rather than the antenna port) also comply with the applicable limits.

For these cabinet radiated spurious emission measurements the EUT transmit antenna may be replaced with a termination matching the nominal impedance of the antenna. Procedures for performing radiated measurements are specified in ANSI C63.10. All detected emissions shall comply with the applicable limits.

The measurement frequency range is from 30 MHz to the 10th harmonic of the fundamental frequency. The Turn Table is actuated to turn from 0° to 360°, and both horizontal and vertical polarizations of the Test Antenna are used to find the maximum radiated power. Mid channels on all channel bandwidth verified. Only the worst RB size/offset presented.

The power of the EUT transmitting frequency should be ignored.

All Spurious Emission tests were performed in X, Y, Z axis direction. And only the worst axis test condition was recorded in this test report.

Use the following spectrum analyzer settings:

Span = wide enough to fully capture the emission being measured

RBW = 1 MHz for $f \geq 1$ GHz, 100 kHz for $f < 1$ GHz

VBW \geq RBW

Sweep = auto

Detector function = peak

Trace = max hold

5.7.4 Test Result

Please refer to ANNEX A.6.

5.8 Band Edge (Restricted-band band-edge)

5.8.1 Limit

FCC §15.209&15.247(d)

Radiated emission outside the frequency band attenuation below the general limits specified in FCC section 15.209(a) is not required. In addition, radiated emissions which fall in the restricted bands, as defined in FCC section 15.205(a), must also comply with the radiated emission limits specified in FCC section 15.209(a).

5.8.2 Test Setup

See section 4.5.1 for test setup description for the antenna port. The photo of test setup please refer to ANNEX B.

5.8.3 Test Procedure

The measurement frequency range is from 9 kHz to the 10th harmonic of the fundamental frequency. The Turn Table is actuated to turn from 0° to 360°, and both horizontal and vertical polarizations of the Test Antenna are used to find the maximum radiated power. Mid channels on all channel bandwidth verified. Only the worst RB size/offset presented.

The power of the EUT transmitting frequency should be ignored.

All Spurious Emission tests were performed in X, Y, Z axis direction. And only the worst axis test condition was recorded in this test report.

Use the following spectrum analyzer settings:

Span = wide enough to fully capture the emission being measured

RBW = 1 MHz for $f \geq 1$ GHz, 100 kHz for $f < 1$ GHz

VBW \geq RBW

Sweep = auto

Detector function = peak

Trace = max hold

For measurement below 1GHz, If the emission level of the EUT measured by the peak detector is 3 dB lower than the applicable limit, the peak emission level will be reported, Otherwise, the emission measurement will be repeated using the quasi-peak detector and reported.

For transmitters operating above 1 GHz repeat the measurement with an average detector.

5.8.4 Test Result

Please refer to ANNEX A.7.

5.9 Power Spectral density (PSD)

5.9.1 Limit

FCC §15.247(e)

The same method of determining the conducted output power shall be used to determine the power spectral density. If a peak output power is measured, then a peak power spectral density measurement is required. If an average output power is measured, then an average power spectral density measurement should be used.

5.9.2 Test Setup

See section 4.5.1 for test setup description for the antenna port. The photo of test setup please refer to ANNEX B.

5.9.3 Test Procedure

Set analyzer center frequency to DTS channel center frequency.

Set the span to 1.5 times the DTS bandwidth.

Set the RBW to: $3 \text{ kHz} \leq \text{RBW} \leq 100 \text{ kHz}$.

Set the VBW $\geq 3 \text{ RBW}$.

Detector = peak.

Sweep time = auto couple.

Trace mode = max hold.

Allow trace to fully stabilize.

Use the peak marker function to determine the maximum amplitude level within the RBW.

If measured value exceeds limit, reduce RBW (no less than 3 kHz) and repeat.

5.9.4 Test Result

Please refer to ANNEX A.8.

ANNEX A TEST RESULT

A.1 Output Power

Duty Cycle

Test Mode	On Time (ms)	On+Off time (ms)	Duty Cycle
802.11b	12.179	12.25	99.42%
802.11g	2.016	2.069	97.44%
802.11n-20 MHz	1.885	1.936	97.37%
802.11n-40 MHz	0.927	0.966	95.96%

Peak Power Test Data

Main Antenna

802.11b Mode:

Channel	Measured Output Peak Power		Limit		Verdict
	dBm	mW	dBm	mW	
Low	15.30	33.88	30	1000	Pass
Middle	16.31	42.76			Pass
High	15.07	32.14			Pass

802.11g Mode:

Channel	Measured Output Peak Power		Limit		Verdict
	dBm	mW	dBm	mW	
Low	19.13	81.85	30	1000	Pass
Middle	24.46	279.25			Pass
High	20.19	104.47			Pass

802.11n-20 MHz Mode:

Channel	Measured Output Peak Power		Limit		Verdict
	dBm	mW	dBm	mW	
Low	18.28	67.30	30	1000	Pass
Middle	24.10	257.04			Pass
High	18.78	75.51			Pass

802.11n-40 MHz Mode:

Channel	Measured Output Peak Power		Limit		Verdict
	dBm	mW	dBm	mW	
Low	16.15	41.21	30	1000	Pass
Middle	24.76	299.23			Pass
High	14.69	29.44			Pass

Aux. Antenna

802.11b Mode:

Channel	Measured Output Peak Power		Limit		Verdict
	dBm	mW	dBm	mW	
Low	16.27	42.36	30	1000	Pass
Middle	17.41	55.08			Pass
High	16.73	47.10			Pass

802.11g Mode:

Channel	Measured Output Peak Power		Limit		Verdict
	dBm	mW	dBm	mW	
Low	19.86	96.83	30	1000	Pass
Middle	24.64	291.07			Pass
High	21.54	142.56			Pass

802.11n-20 MHz Mode:

Channel	Measured Output Peak Power		Limit		Verdict
	dBm	mW	dBm	mW	
Low	19.23	83.75	30	1000	Pass
Middle	24.38	274.16			Pass
High	19.98	99.54			Pass

802.11n-40 MHz Mode:

Channel	Measured Output Peak Power		Limit		Verdict
	dBm	mW	dBm	mW	
Low	17.66	58.34	30	1000	Pass
Middle	25.31	339.63			Pass
High	16.19	41.59			Pass

MIMO-Main Antenna

802.11n-20 MHz Mode:

Channel	Measured Output Peak Power		Limit		Verdict
	dBm	mW	dBm	mW	
Low	18.08	64.27	30	1000	Pass
Middle	24.09	256.45			Pass
High	17.08	51.05			Pass

802.11n-40 MHz Mode:

Channel	Measured Output Peak Power		Limit		Verdict
	dBm	mW	dBm	mW	
Low	15.16	32.81	30	1000	Pass
Middle	24.47	279.90			Pass
High	14.48	28.05			Pass

MIMO-Aux. Antenna

802.11n-20 MHz Mode:

Channel	Measured Output Peak Power		Limit		Verdict
	dBm	mW	dBm	mW	
Low	18.72	74.47	30	1000	Pass
Middle	24.51	282.49			Pass
High	18.64	73.11			Pass

802.11n-40 MHz Mode:

Channel	Measured Output Peak Power		Limit		Verdict
	dBm	mW	dBm	mW	
Low	16.13	41.02	30	1000	Pass
Middle	25.50	354.81			Pass
High	15.61	36.39			Pass

MIMO

802.11n-20 MHz Mode:

Channel	Measured Output Peak Power		Limit		Verdict
	dBm	mW	dBm	mW	
Low	21.42	138.74	30	1000	Pass
Middle	27.32	538.94			Pass
High	20.94	124.16			Pass

802.11n-40 MHz Mode:

Channel	Measured Output Peak Power		Limit		Verdict
	dBm	mW	dBm	mW	
Low	18.68	73.83	30	1000	Pass
Middle	28.03	634.71			Pass
High	18.09	64.45			Pass

Average Power Test Data

Main Antenna

802.11b Mode:

Channel	Measured Output Average Power		Limit		Verdict
	dBm	mW	dBm	mW	
Low	11.79	15.10	30	1000	Pass
Middle	13.04	20.14			Pass
High	12.64	18.37			Pass

802.11g Mode:

Channel	Measured Output Average Power		Limit		Verdict
	dBm	mW	dBm	mW	
Low	12.12	16.29	30	1000	Pass
Middle	17.85	60.95			Pass
High	14.23	26.49			Pass

802.11n-20 MHz Mode:

Channel	Measured Output Average Power		Limit		Verdict
	dBm	mW	dBm	mW	
Low	11.44	13.93	30	1000	Pass
Middle	17.75	59.57			Pass
High	12.84	19.23			Pass

802.11n-40 MHz Mode:

Channel	Measured Output Average Power		Limit		Verdict
	dBm	mW	dBm	mW	
Low	9.32	8.55	30	1000	Pass
Middle	17.66	58.34			Pass
High	8.65	7.33			Pass

Aux. Antenna

802.11b Mode:

Channel	Measured Output Average Power		Limit		Verdict
	dBm	mW	dBm	mW	
Low	13.29	21.33	30	1000	Pass
Middle	14.11	25.76			Pass
High	13.29	21.33			Pass

802.11g Mode:

Channel	Measured Output Average Power		Limit		Verdict
	dBm	mW	dBm	mW	
Low	13.38	21.78	30	1000	Pass
Middle	17.75	59.57			Pass
High	14.42	27.67			Pass

802.11n-20 MHz Mode:

Channel	Measured Output Average Power		Limit		Verdict
	dBm	mW	dBm	mW	
Low	12.60	18.20	30	1000	Pass
Middle	17.81	60.39			Pass
High	13.17	20.75			Pass

802.11n-40 MHz Mode:

Channel	Measured Output Average Power		Limit		Verdict
	dBm	mW	dBm	mW	
Low	10.88	12.25	30	1000	Pass
Middle	17.93	62.09			Pass
High	9.28	8.47			Pass

MIMO-Main Antenna

802.11n-20 MHz Mode:

Channel	Measured Output Average Power		Limit		Verdict
	dBm	mW	dBm	mW	
Low	10.88	12.25	30	1000	Pass
Middle	17.84	60.81			Pass
High	11.07	12.79			Pass

802.11n-40 MHz Mode:

Channel	Measured Output Average Power		Limit		Verdict
	dBm	mW	dBm	mW	
Low	7.69	5.87	30	1000	Pass
Middle	17.71	59.02			Pass
High	8.06	6.40			Pass

MIMO-Aux. Antenna

802.11n-20 MHz Mode:

Channel	Measured Output Average Power		Limit		Verdict
	dBm	mW	dBm	mW	
Low	12.38	17.30	30	1000	Pass
Middle	17.65	58.21			Pass
High	11.99	15.81			Pass

802.11n-40 MHz Mode:

Channel	Measured Output Average Power		Limit		Verdict
	dBm	mW	dBm	mW	
Low	9.58	9.08	30	1000	Pass
Middle	17.93	62.09			Pass
High	8.89	7.74			Pass

MIMO

802.11n-20 MHz Mode:

Channel	Measured Output Average Power		Limit		Verdict
	dBm	mW	dBm	mW	
Low	14.70	29.54	30	1000	Pass
Middle	20.76	119.02			Pass
High	14.56	28.61			Pass

802.11n-40 MHz Mode:

Channel	Measured Output Average Power		Limit		Verdict
	dBm	mW	dBm	mW	
Low	11.75	14.95	30	1000	Pass
Middle	20.83	121.11			Pass
High	11.51	14.14			Pass

A.2 Bandwidth

Test Data

Main Antenna

802.11b Mode:

Channel	6 dB Bandwidth (MHz)	99% Bandwidth (MHz)	6 dB Bandwidth Limits (kHz)
Low	10.162598	13.256151	≥500
Middle	10.162598	13.256151	≥500
High	10.112549	13.256151	≥500

802.11g Mode:

Channel	6 dB Bandwidth (MHz)	99% Bandwidth (MHz)	6 dB Bandwidth Limits (kHz)
Low	15.168945	16.324168	≥500
Middle	15.168945	16.382055	≥500
High	15.218994	16.266281	≥500

802.11n-20MHz Mode:

Channel	6 dB Bandwidth (MHz)	99% Bandwidth (MHz)	6 dB Bandwidth Limits (kHz)
Low	15.168945	17.250362	≥500
Middle	15.218994	17.424023	≥500
High	15.218994	17.250362	≥500

802.11n-40MHz Mode:

Channel	6 dB Bandwidth (MHz)	99% Bandwidth (MHz)	6 dB Bandwidth Limits (kHz)
Low	33.971191	35.800000	≥500
Middle	33.971191	36.000000	≥500
High	33.921143	35.900000	≥500

Aux. Antenna

802.11b Mode:

Channel	6 dB Bandwidth (MHz)	99% Bandwidth (MHz)	6 dB Bandwidth Limits (kHz)
Low	10.162598	13.429812	≥500
Middle	10.162598	13.429812	≥500
High	10.112549	13.429812	≥500

802.11g Mode:

Channel	6 dB Bandwidth (MHz)	99% Bandwidth (MHz)	6 dB Bandwidth Limits (kHz)
Low	15.168945	16.266281	≥500
Middle	15.218994	16.613603	≥500
High	15.218994	16.382055	≥500

802.11n-20MHz Mode:

Channel	6 dB Bandwidth (MHz)	99% Bandwidth (MHz)	6 dB Bandwidth Limits (kHz)
Low	15.218994	17.308249	≥500
Middle	15.168945	17.539797	≥500
High	15.218994	17.366136	≥500

802.11n-40MHz Mode:

Channel	6 dB Bandwidth (MHz)	99% Bandwidth (MHz)	6 dB Bandwidth Limits (kHz)
Low	33.971191	35.900000	≥500
Middle	32.720459	36.400000	≥500
High	33.971191	35.900000	≥500

Test Plots

Main Antenna

6 dB Bandwidth

802.11b LOW CHANNEL

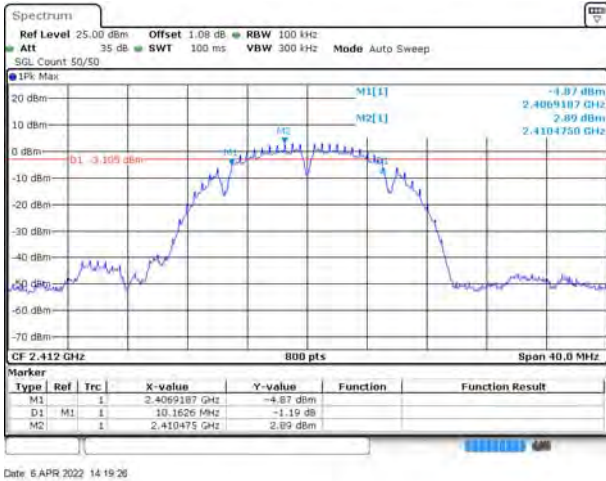

802.11b MIDDLE CHANNEL

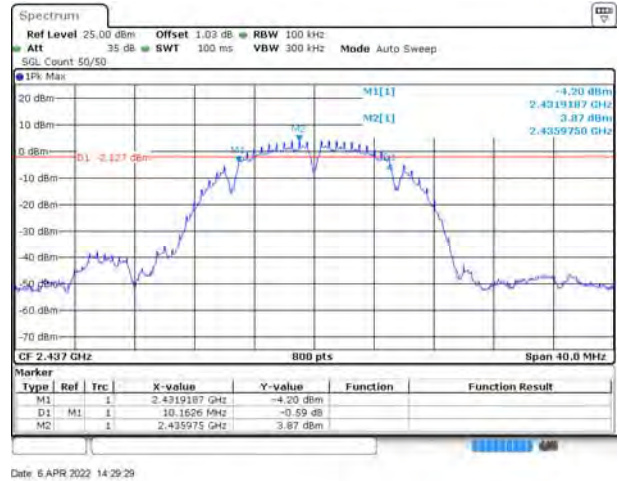

802.11b HIGH CHANNEL

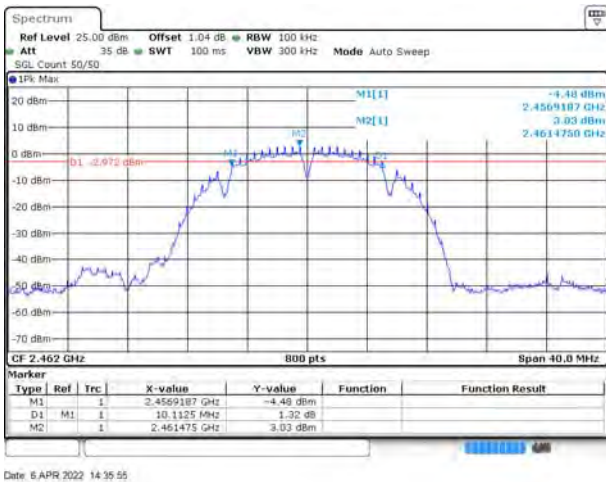

802.11g LOW CHANNEL

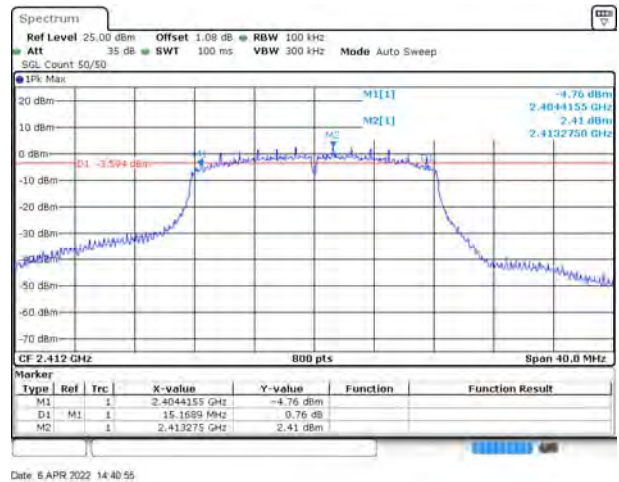

802.11g MIDDLE CHANNEL

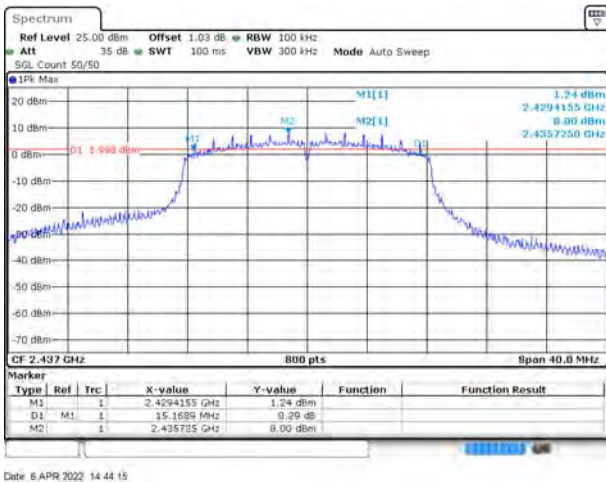

802.11g HIGH CHANNEL

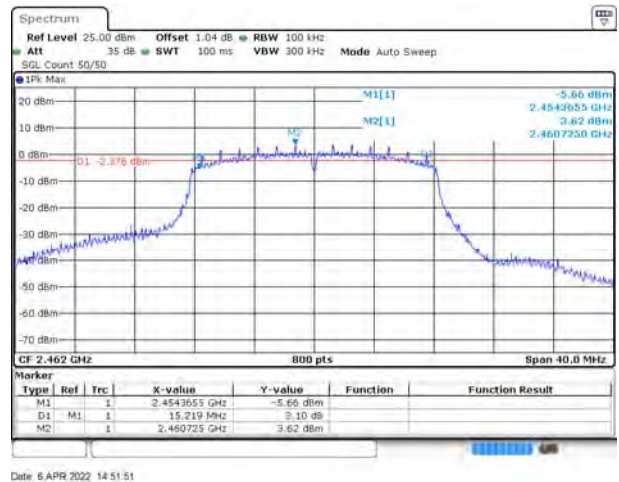

802.11n-20 MHz LOW CHANNEL

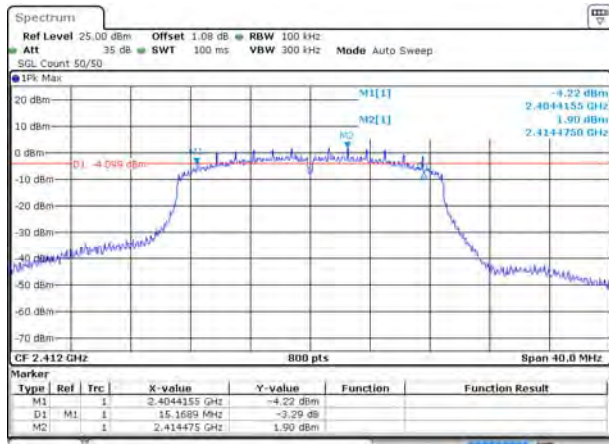

Date: 6 APR 2022 14:59:05

802.11n-20 MHz MIDDLE CHANNEL

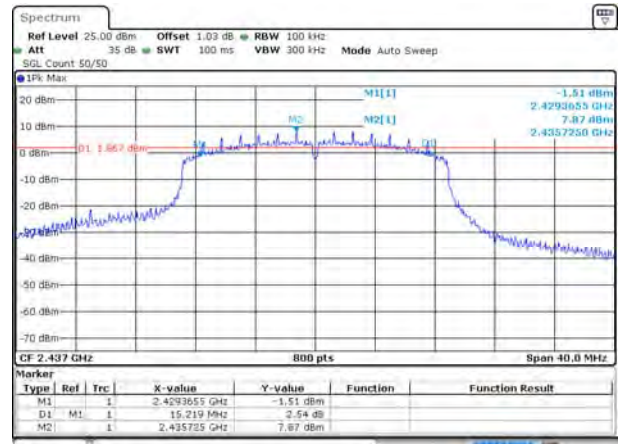

Date: 6 APR 2022 15:03:19

802.11n-20 MHz HIGH CHANNEL



Date: 6 APR 2022 15:05:54

802.11n-40 MHz LOW CHANNEL

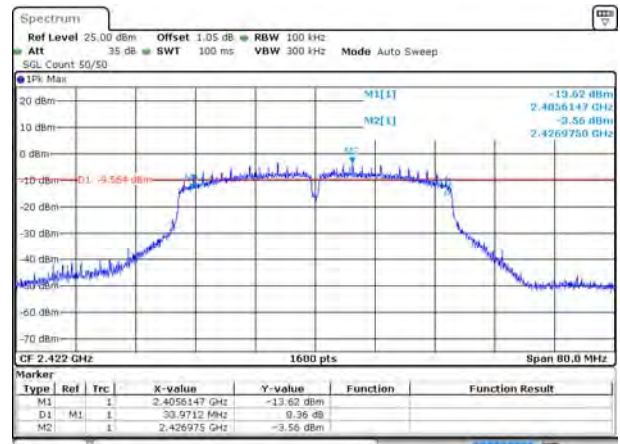

Date: 6 APR 2022 15:09:34

802.11n-40 MHz MIDDLE CHANNEL

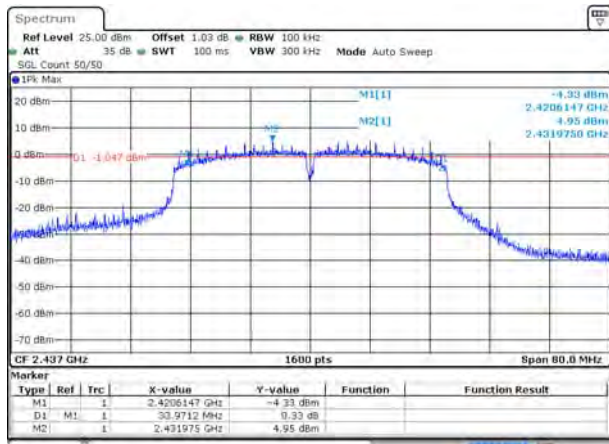

Date: 6 APR 2022 15:15:10

802.11n-40 MHz HIGH CHANNEL

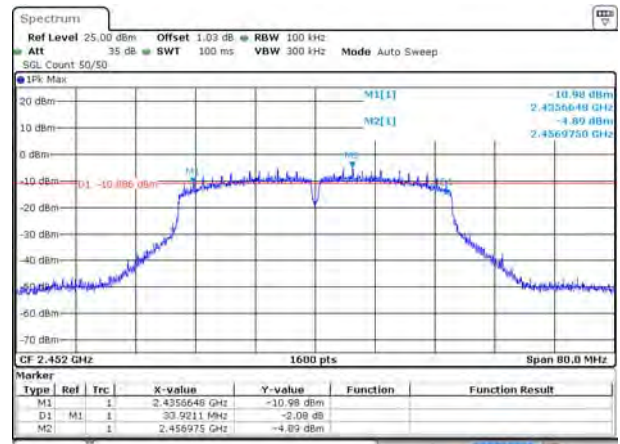

Date: 6 APR 2022 15:20:54

99% Bandwidth

802.11b LOW CHANNEL

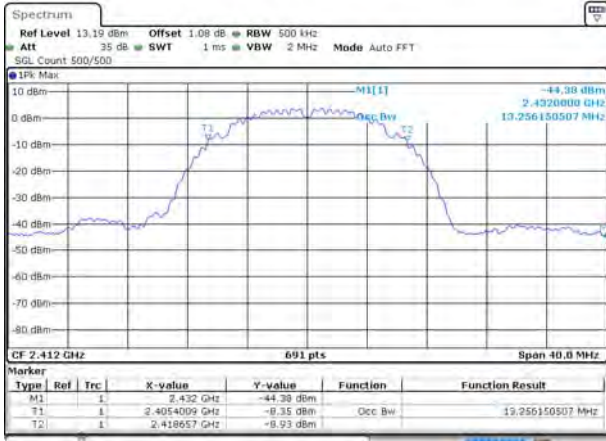

Date: 8 APR 2022 14:19:34

802.11b MIDDLE CHANNEL



Date: 8 APR 2022 14:29:38

802.11b HIGH CHANNEL

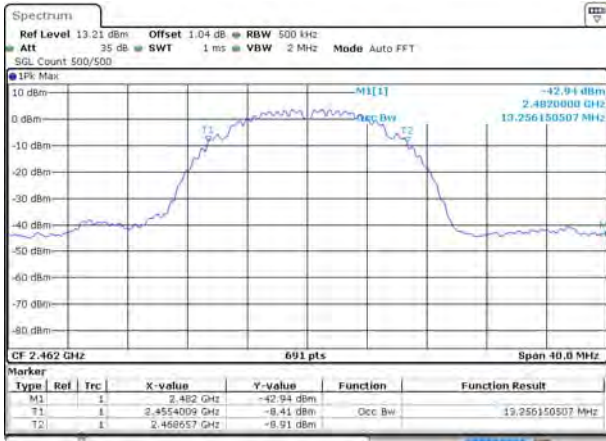

Date: 8 APR 2022 14:38:04

802.11g LOW CHANNEL



Date: 8 APR 2022 14:41:04

802.11g MIDDLE CHANNEL



Date: 8 APR 2022 14:44:24

802.11g HIGH CHANNEL



Date: 8 APR 2022 14:52:00

802.11n-20 MHz LOW CHANNEL

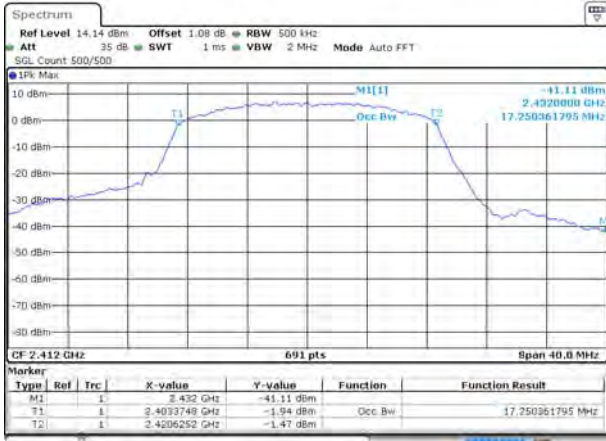

Date: 8 APR 2022 14:58:13

802.11n-20 MHz MIDDLE CHANNEL



Date: 8 APR 2022 15:03:29

802.11n-20 MHz HIGH CHANNEL



Date: 8 APR 2022 15:06:03

802.11n-40 MHz LOW CHANNEL



Date: 8 APR 2022 15:09:44

802.11n-40 MHz MIDDLE CHANNEL



Date: 8 APR 2022 15:15:20

802.11n-40 MHz HIGH CHANNEL

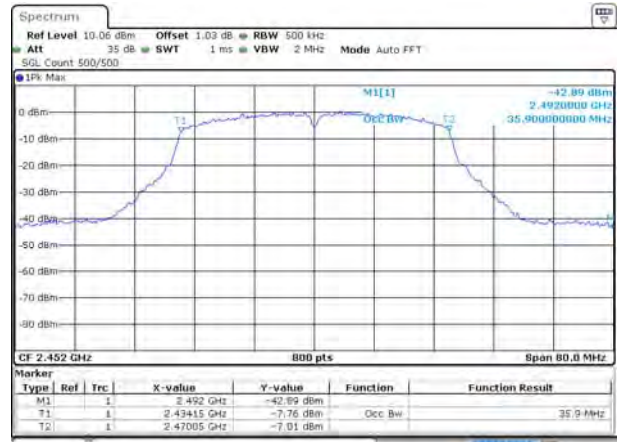

Date: 8 APR 2022 15:21:05

Aux. Antenna
6 dB Bandwidth

802.11b LOW CHANNEL

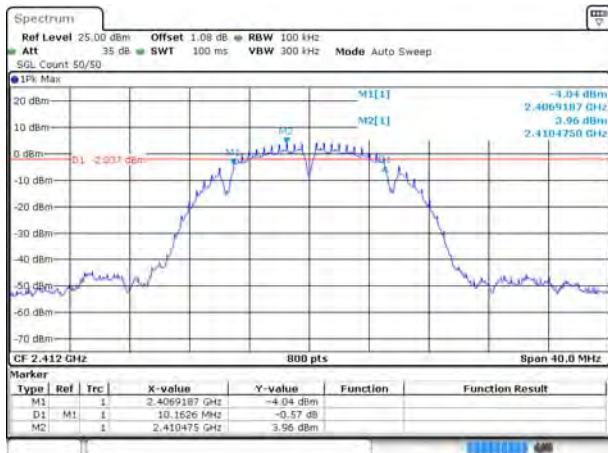

Date: 6 APR 2022 17:13:48

802.11b MIDDLE CHANNEL



Date: 6 APR 2022 17:17:02

802.11b HIGH CHANNEL

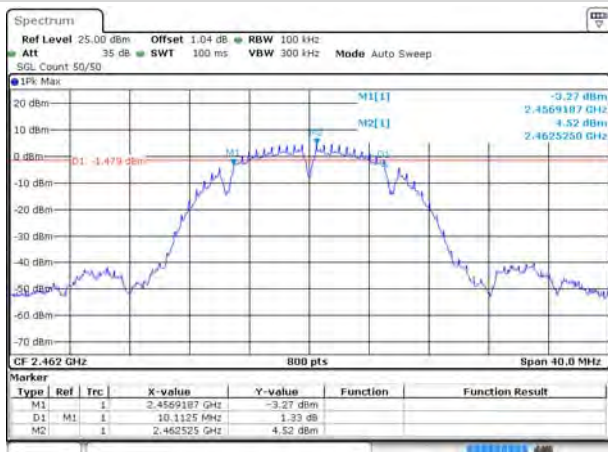

Date: 6 APR 2022 17:19:57

802.11g LOW CHANNEL

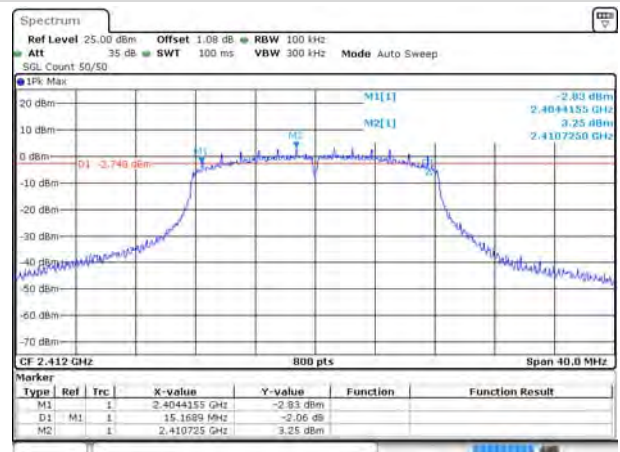

Date: 6 APR 2022 17:27:26

802.11g MIDDLE CHANNEL

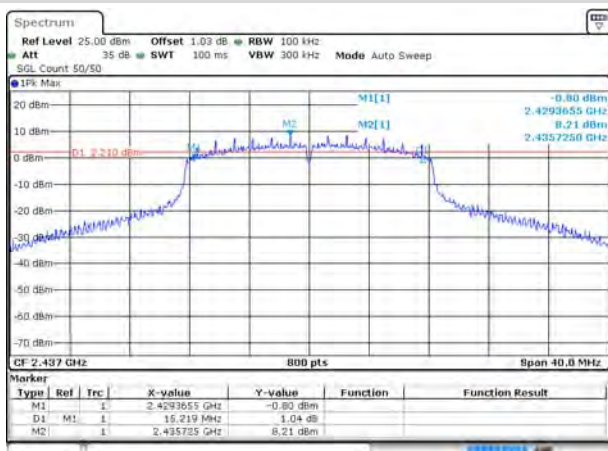

Date: 6 APR 2022 17:31:09

802.11g HIGH CHANNEL

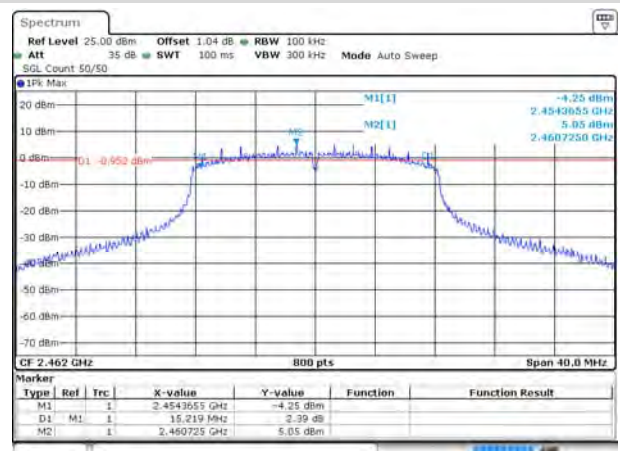

Date: 6 APR 2022 18:13:19

802.11n-20 MHz LOW CHANNEL

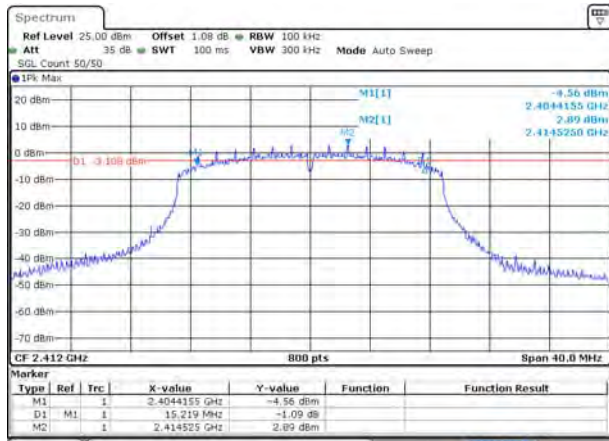

Date: 6 APR 2022 16:16:26

802.11n-20 MHz MIDDLE CHANNEL

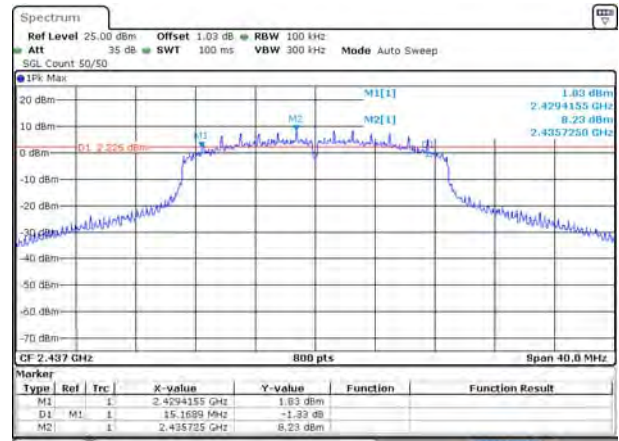

Date: 6 APR 2022 16:19:18

802.11n-20 MHz HIGH CHANNEL

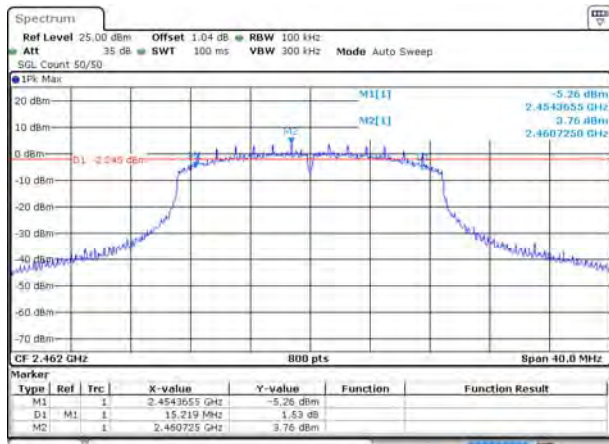

Date: 6 APR 2022 16:21:41

802.11n-40 MHz LOW CHANNEL

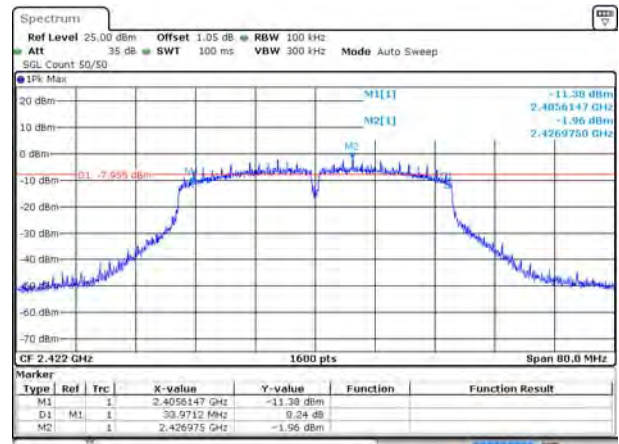

Date: 6 APR 2022 16:24:46

802.11n-40 MHz MIDDLE CHANNEL

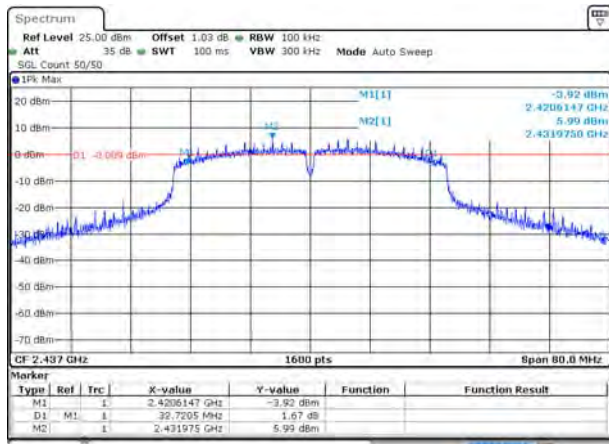

Date: 6 APR 2022 16:26:12

802.11n-40 MHz HIGH CHANNEL

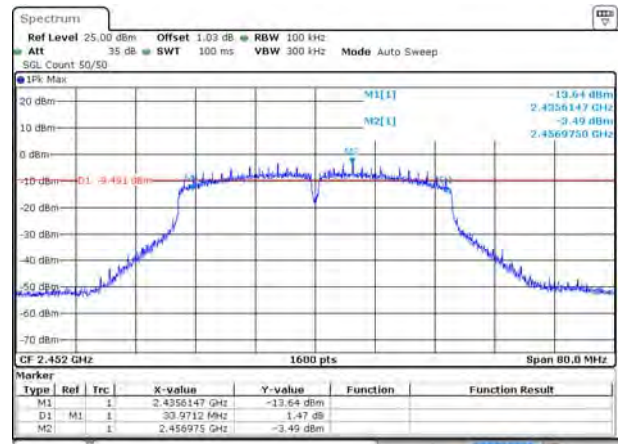

Date: 6 APR 2022 16:32:46

99% Bandwidth

802.11b LOW CHANNEL

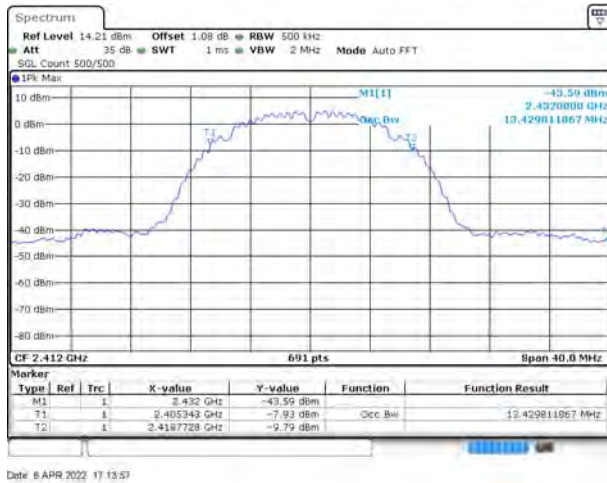

802.11b MIDDLE CHANNEL

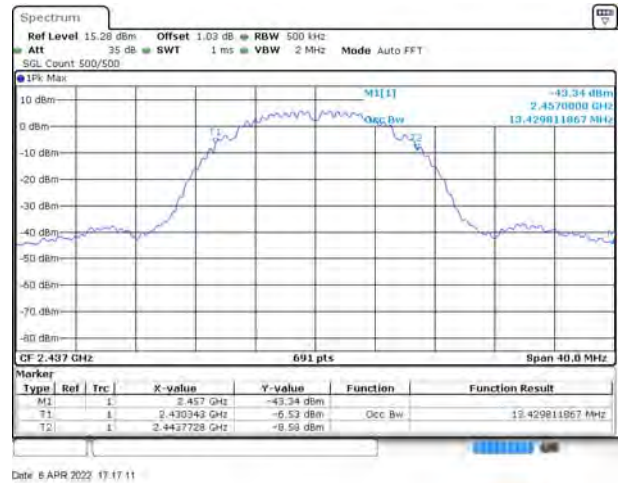

802.11b HIGH CHANNEL



802.11g LOW CHANNEL

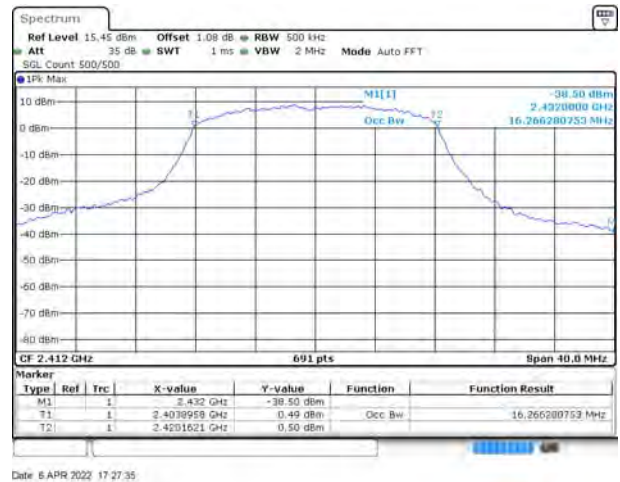

802.11g MIDDLE CHANNEL

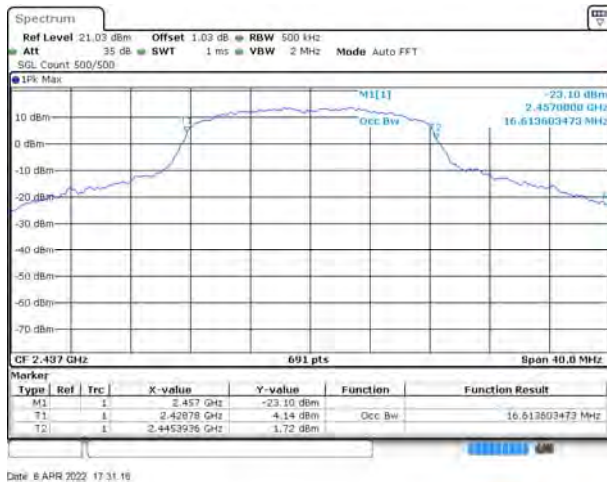

802.11g HIGH CHANNEL

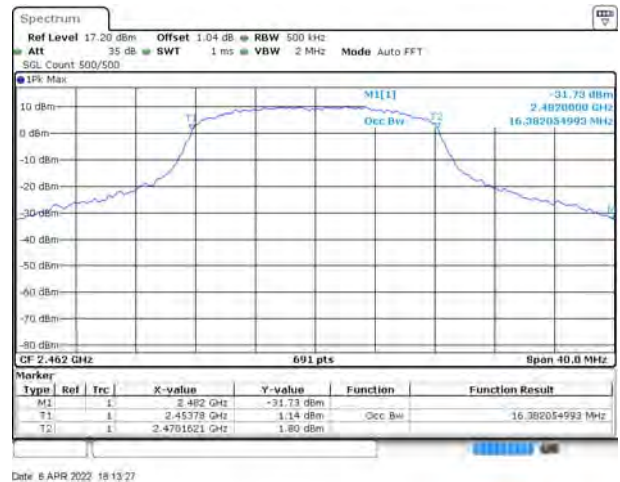

802.11n-20 MHz LOW CHANNEL



Date: 6 APR 2022 16:16:34

802.11n-20 MHz MIDDLE CHANNEL

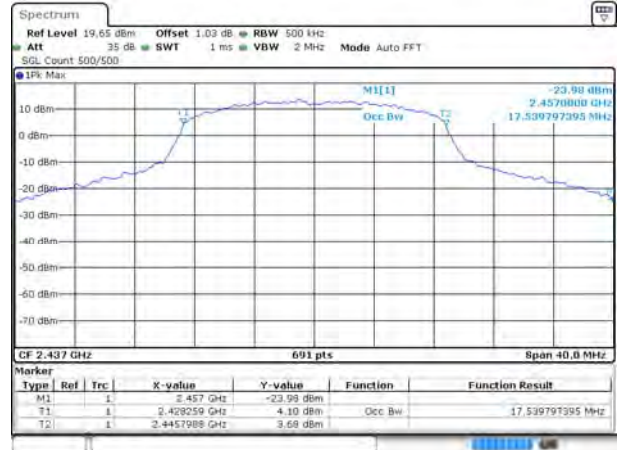

Date: 6 APR 2022 16:19:29

802.11n-20 MHz HIGH CHANNEL

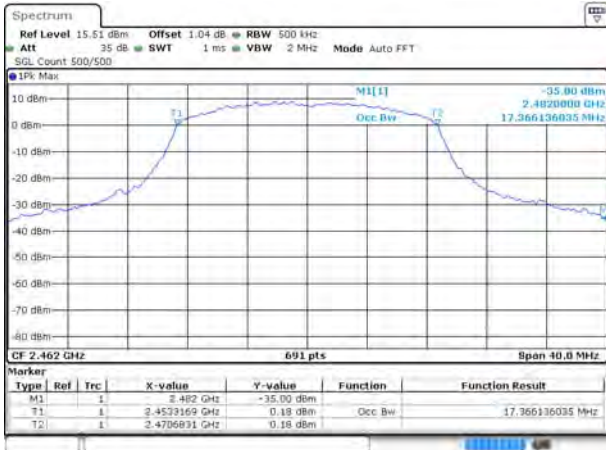

Date: 6 APR 2022 16:21:50

802.11n-40 MHz LOW CHANNEL



Date: 6 APR 2022 16:24:57

802.11n-40 MHz MIDDLE CHANNEL

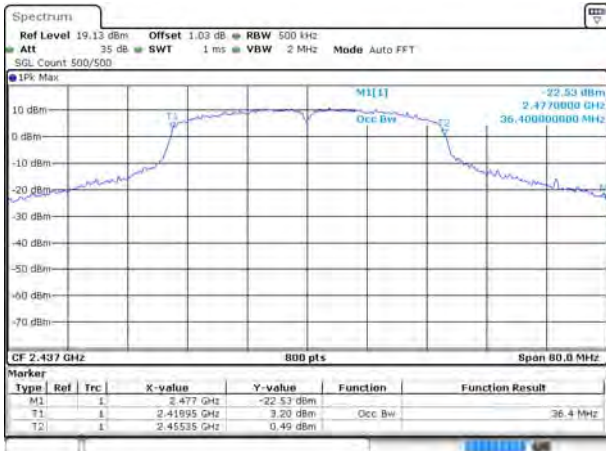

Date: 6 APR 2022 16:26:23

802.11n-40 MHz HIGH CHANNEL



Date: 6 APR 2022 16:32:55

A.3 Conducted Spurious Emissions

Test Data

Main Antenna

802.11b Mode:

Channel	Measured Max. Out of Band Emission (dBm)	Limit (dBm)		Verdict
		Carrier Level	Calculated 20 dBc Limit	
Low	-32.01	2.75	-17.25	Pass
Middle	-28.71	4.23	-15.77	Pass
High	-32.94	3.00	-17.00	Pass

802.11g Mode:

Channel	Measured Max. Out of Band Emission (dBm)	Limit (dBm)		Verdict
		Carrier Level	Calculated 20 dBc Limit	
Low	-38.77	2.69	-17.31	Pass
Middle	-33.48	8.25	-11.75	Pass
High	-41.49	3.80	-16.20	Pass

802.11n-20MHz Mode:

Channel	Measured Max. Out of Band Emission (dBm)	Limit (dBm)		Verdict
		Carrier Level	Calculated 20 dBc Limit	
Low	-43.06	2.14	-17.86	Pass
Middle	-33.46	8.12	-11.88	Pass
High	-39.43	2.75	-17.25	Pass

802.11n-40MHz Mode:

Channel	Measured Max. Out of Band Emission (dBm)	Limit (dBm)		Verdict
		Carrier Level	Calculated 20 dBc Limit	
Low	-49.27	-3.47	-23.47	Pass
Middle	-37.34	5.09	-14.91	Pass
High	-51.43	-4.79	-24.79	Pass

Aux. Antenna

802.11b Mode:

Channel	Measured Max. Out of Band Emission (dBm)	Limit (dBm)		Verdict
		Carrier Level	Calculated 20 dBc Limit	
Low	-39.15	4.09	-15.91	Pass
Middle	-38.10	5.18	-14.82	Pass
High	-42.36	4.40	-15.60	Pass

802.11g Mode:

Channel	Measured Max. Out of Band Emission (dBm)	Limit (dBm)		Verdict
		Carrier Level	Calculated 20 dBc Limit	
Low	-48.50	3.56	-16.44	Pass
Middle	-43.08	8.38	-11.62	Pass
High	-50.27	5.12	-14.88	Pass

802.11n-20MHz Mode:

Channel	Measured Max. Out of Band Emission (dBm)	Limit (dBm)		Verdict
		Carrier Level	Calculated 20 dBc Limit	
Low	-48.69	3.13	-16.87	Pass
Middle	-45.26	8.34	-11.66	Pass
High	-52.33	3.82	-16.18	Pass

802.11n-40MHz Mode:

Channel	Measured Max. Out of Band Emission (dBm)	Limit (dBm)		Verdict
		Carrier Level	Calculated 20 dBc Limit	
Low	-53.17	-1.83	-21.83	Pass
Middle	-46.87	6.26	-13.74	Pass
High	-54.19	-3.37	-23.37	Pass

MIMO-Main Antenna

802.11n-20MHz Mode:

Channel	Measured Max. Out of Band Emission (dBm)	Limit (dBm)		Verdict
		Carrier Level	Calculated 20 dBc Limit	
Low	-43.22	1.72	-18.28	Pass
Middle	-36.39	7.99	-12.01	Pass
High	-46.89	1.39	-18.61	Pass

802.11n-40MHz Mode:

Channel	Measured Max. Out of Band Emission (dBm)	Limit (dBm)		Verdict
		Carrier Level	Calculated 20 dBc Limit	
Low	-52.53	-4.74	-24.74	Pass
Middle	-39.11	4.57	-15.43	Pass
High	-54.10	-4.77	-24.77	Pass

MIMO-Aux. Antenna

802.11n-20MHz Mode:

Channel	Measured Max. Out of Band Emission (dBm)	Limit (dBm)		Verdict
		Carrier Level	Calculated 20 dBc Limit	
Low	-49.14	2.30	-17.70	Pass
Middle	-44.28	8.83	-11.17	Pass
High	-53.38	2.91	-17.09	Pass

802.11n-40MHz Mode:

Channel	Measured Max. Out of Band Emission (dBm)	Limit (dBm)		Verdict
		Carrier Level	Calculated 20 dBc Limit	
Low	-53.52	-3.48	-23.48	Pass
Middle	-47.26	5.98	-14.02	Pass
High	-54.15	-3.45	-23.45	Pass

Test Plots

Main Antenna

802.11b LOW CHANNEL CARRIER LEVEL



Date: 6 APR 2022 18:54:15

802.11b LOW CHANNEL, SPURIOUS 30 MHz ~ 3 GHz 802.11b LOW CHANNEL, SPURIOUS 2 GHz ~ 25 GHz

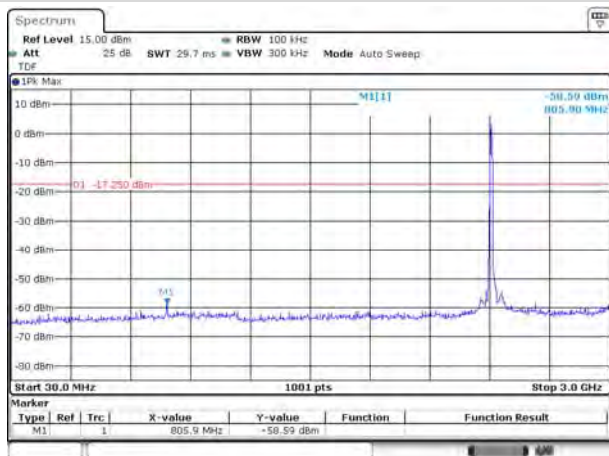

Date: 6 APR 2022 18:54:46

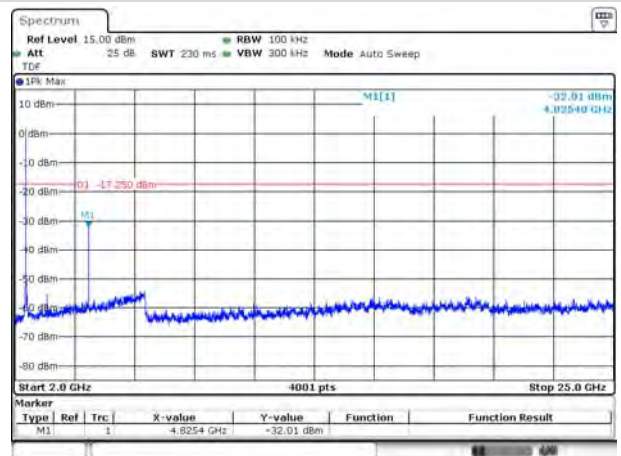

Date: 6 APR 2022 18:54:57

802.11b MIDDLE CHANNEL CARRIER LEVEL

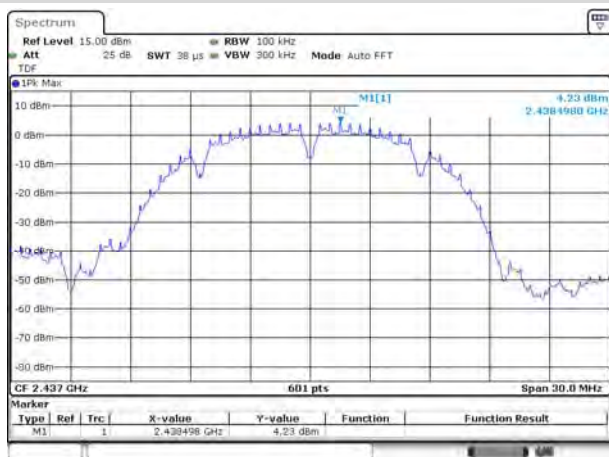

Date: 6 APR 2022 14:39:14

802.11b MIDDLE CHANNEL, SPURIOUS
30 MHz ~ 3 GHz

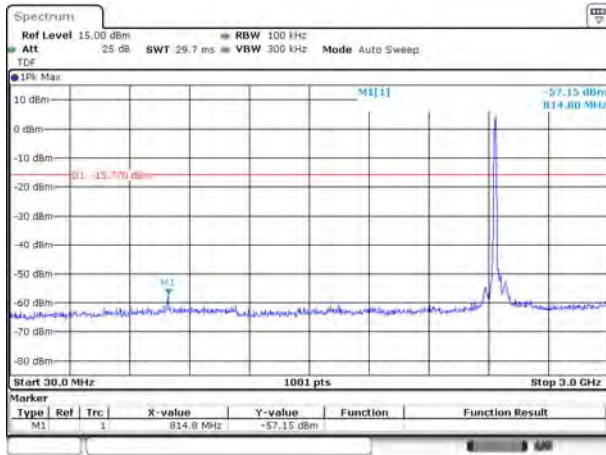

Date: 6 APR 2022 14:31:08

802.11b MIDDLE CHANNEL, SPURIOUS
2 GHz ~ 25 GHz

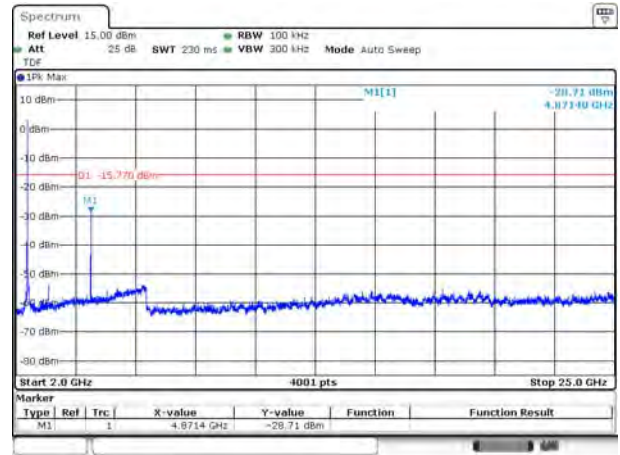

Date: 6 APR 2022 14:31:40

802.11b HIGH CHANNEL CARRIER LEVEL

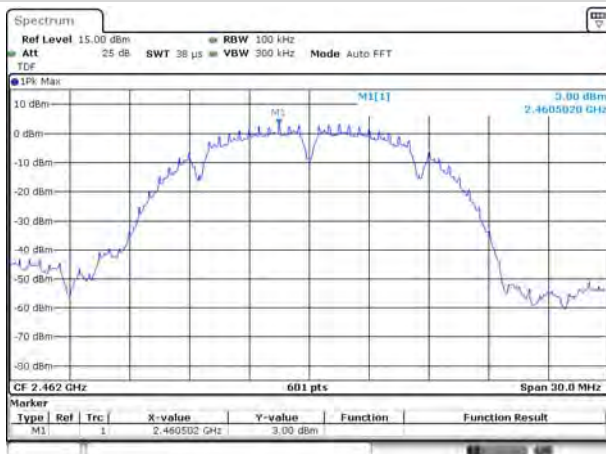

Date: 6 APR 2022 14:36:23

802.11b HIGH CHANNEL, SPURIOUS
30 MHz ~ 3 GHz

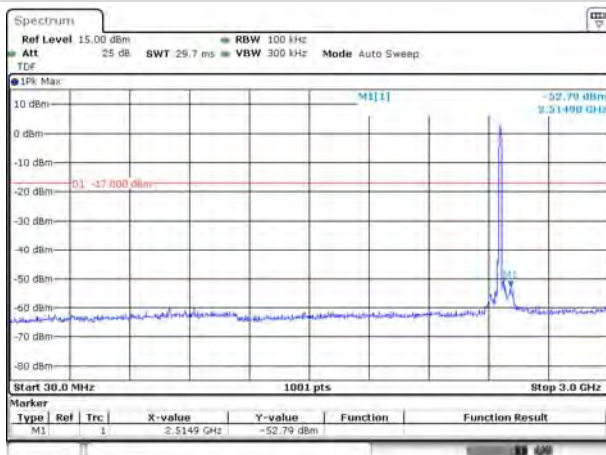

Date: 6 APR 2022 14:38:01

802.11b HIGH CHANNEL, SPURIOUS
2 GHz ~ 25 GHz

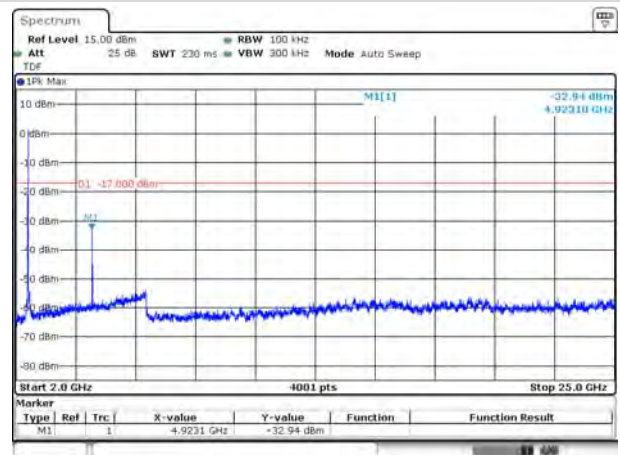

Date: 6 APR 2022 14:38:21

802.11g LOW CHANNEL CARRIER LEVEL

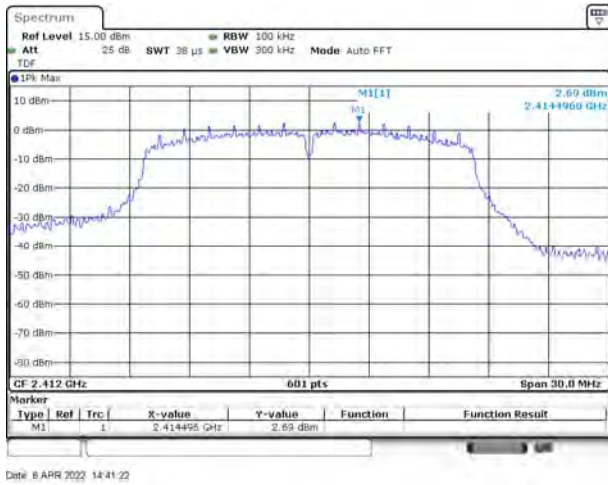

Date: 6 APR 2022 14:41:22

802.11g LOW CHANNEL, SPURIOUS 30 MHz ~ 3 GHz

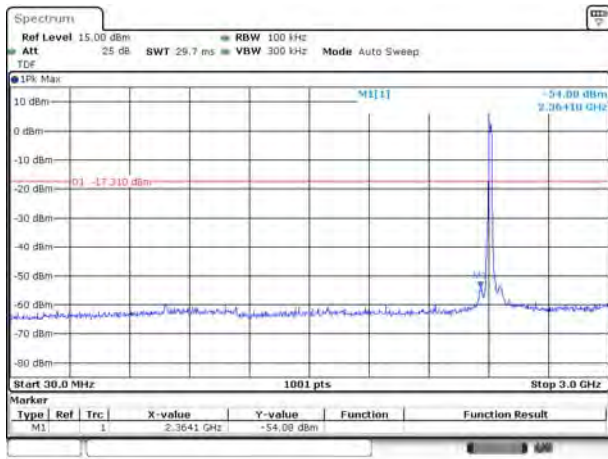

Date: 6 APR 2022 14:42:27

802.11g LOW CHANNEL, SPURIOUS 2 GHz ~ 25 GHz

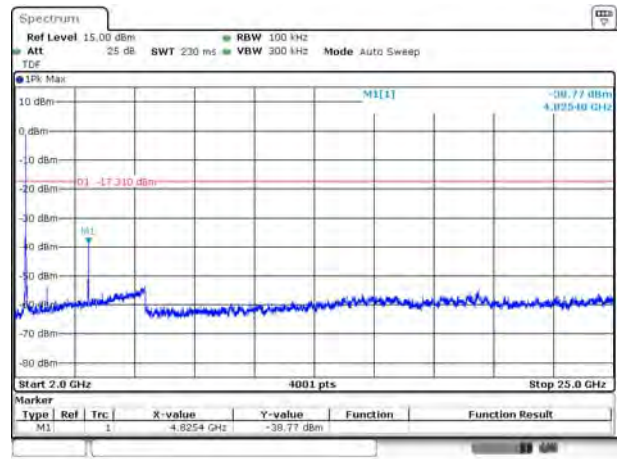

Date: 6 APR 2022 14:42:51

802.11g MIDDLE CHANNEL CARRIER LEVEL

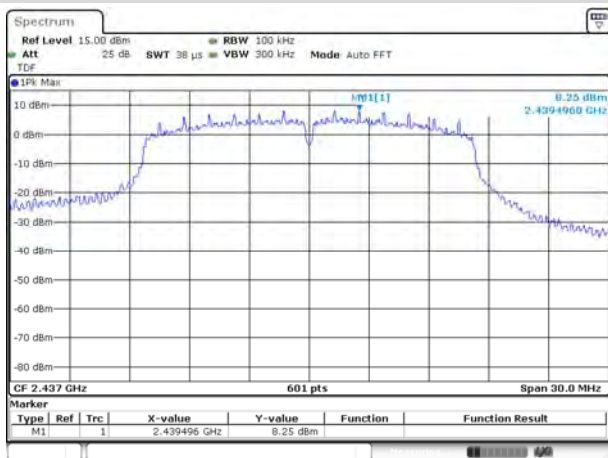

Date: 6 APR 2022 14:55:06

802.11g MIDDLE CHANNEL, SPURIOUS
30 MHz ~ 3 GHz

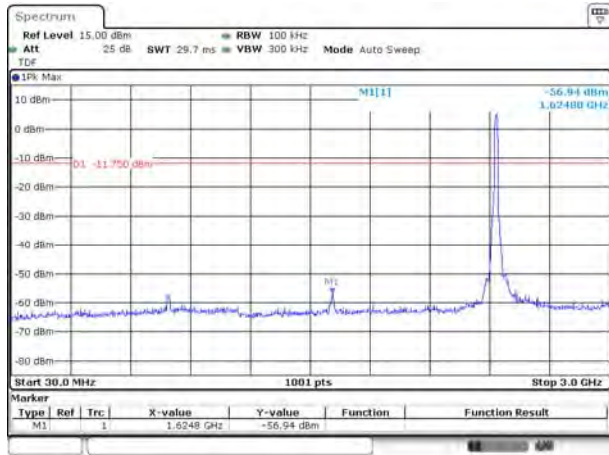

Date: 6 APR 2022 14:55:33

802.11g MIDDLE CHANNEL, SPURIOUS
2 GHz ~ 25 GHz

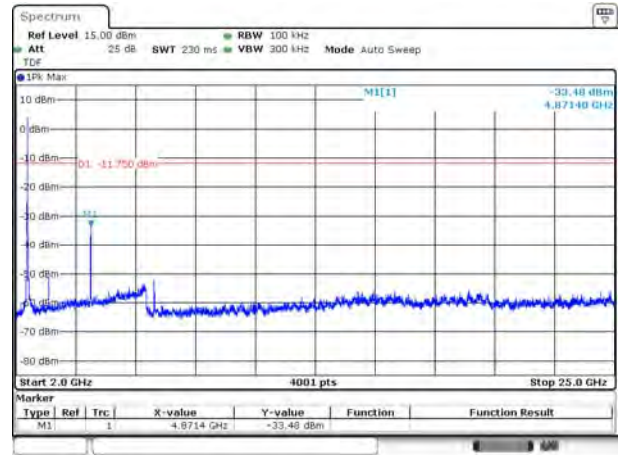

Date: 6 APR 2022 14:55:46

802.11g HIGH CHANNEL CARRIER LEVEL

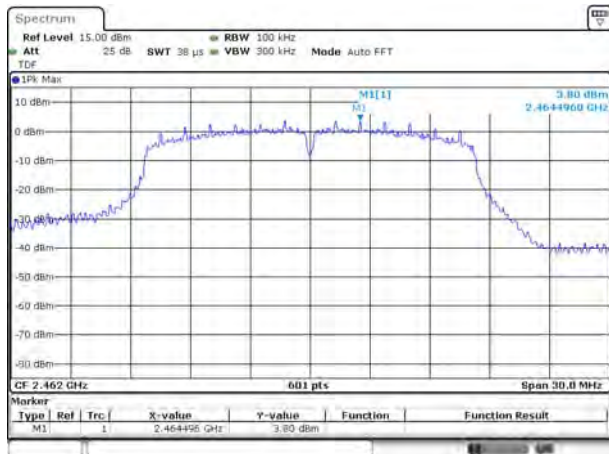

Date: 6 APR 2022 14:52:38

802.11g HIGH CHANNEL, SPURIOUS
30 MHz ~ 3 GHz

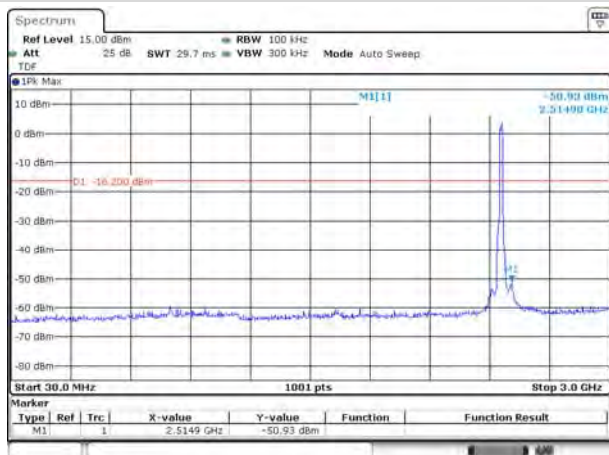

Date: 6 APR 2022 14:53:23

802.11g HIGH CHANNEL, SPURIOUS
2 GHz ~ 25 GHz

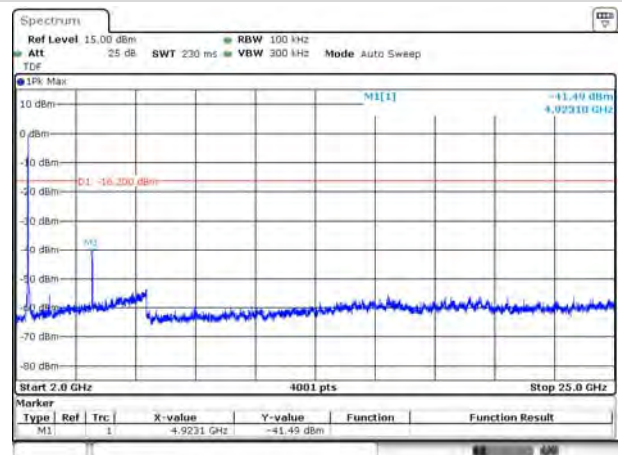

Date: 6 APR 2022 14:53:37

802.11n-20 MHz LOW CHANNEL CARRIER LEVEL

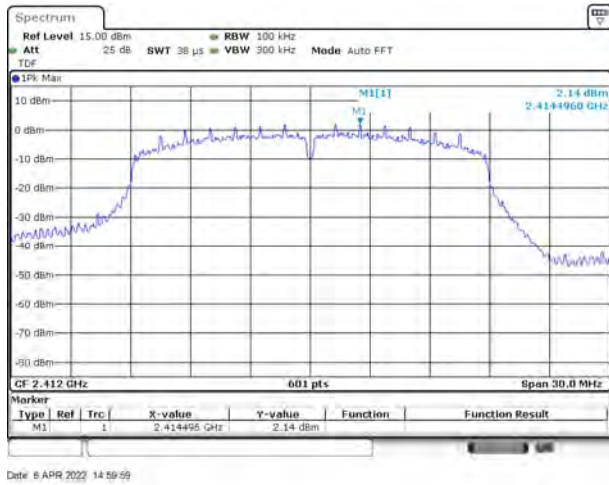

Date: 6 APR 2022 14:59:59

802.11n-20 MHz LOW CHANNEL, SPURIOUS
30 MHz ~ 3 GHz

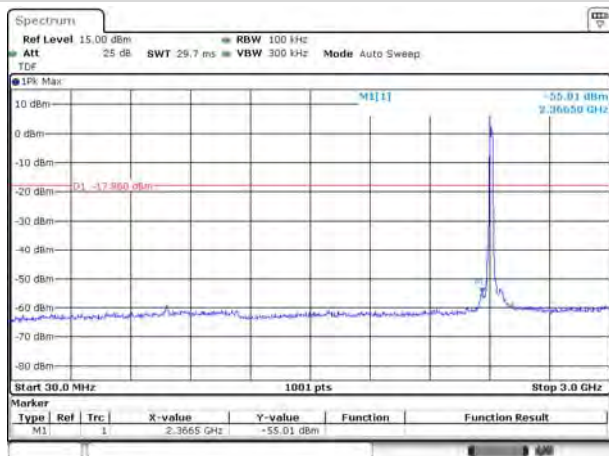

Date: 6 APR 2022 15:01:37

802.11n-20 MHz LOW CHANNEL, SPURIOUS
2 GHz ~ 25 GHz

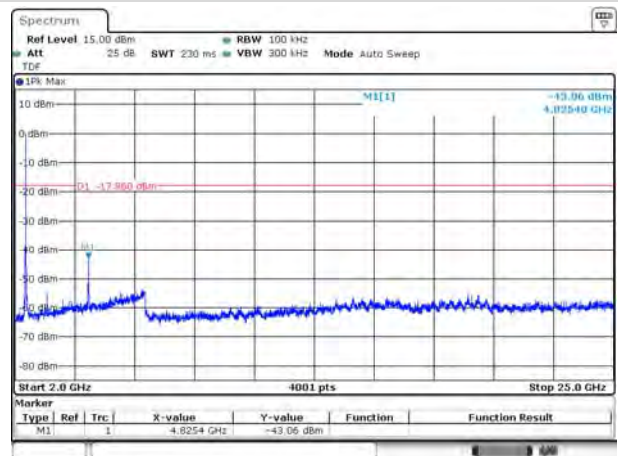

Date: 6 APR 2022 15:01:53

802.11n-20 MHz MIDDLE CHANNEL CARRIER LEVEL

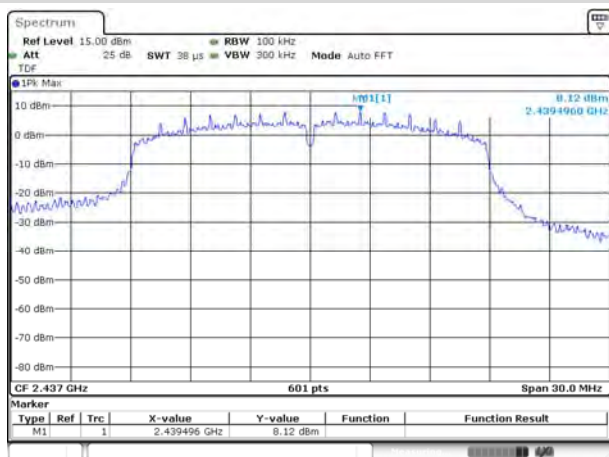

Date: 6 APR 2022 15:03:49

802.11n-20 MHz MIDDLE CHANNEL, SPURIOUS
30 MHz ~ 3 GHz

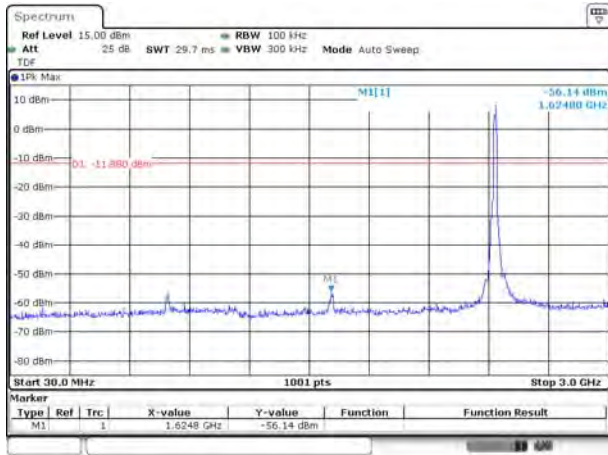

Date: 6 APR 2022 15:04:22

802.11n-20 MHz MIDDLE CHANNEL, SPURIOUS
2 GHz ~ 25 GHz

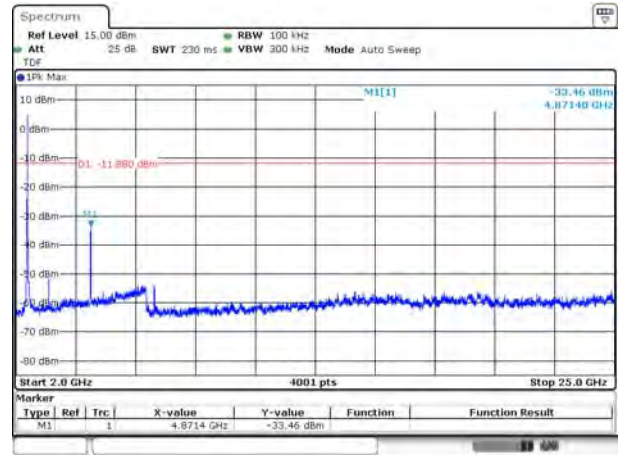

Date: 6 APR 2022 15:04:42

802.11n-20 MHz HIGH CHANNEL CARRIER LEVEL

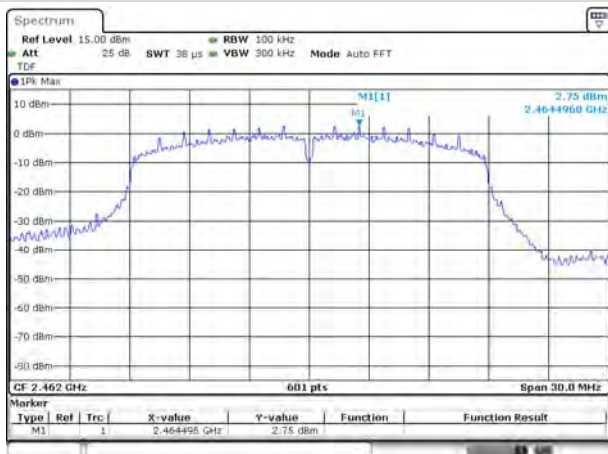

Date: 6 APR 2022 15:06:28

802.11n-20 MHz HIGH CHANNEL, SPURIOUS
30 MHz ~ 3 GHz

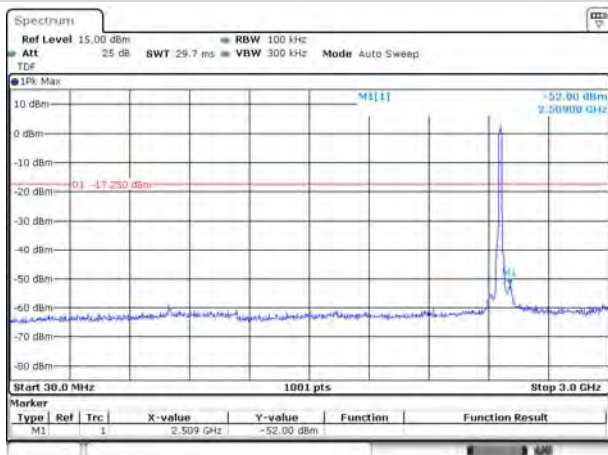

Date: 6 APR 2022 15:07:34

802.11n-20 MHz HIGH CHANNEL, SPURIOUS
2 GHz ~ 25 GHz

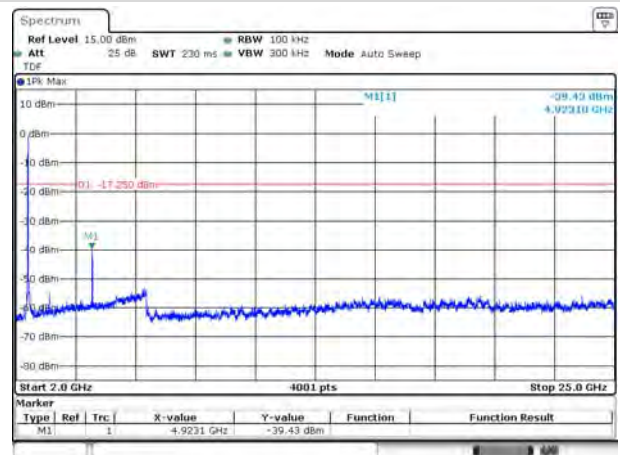

Date: 6 APR 2022 15:07:57

802.11n-40 MHz LOW CHANNEL CARRIER LEVEL

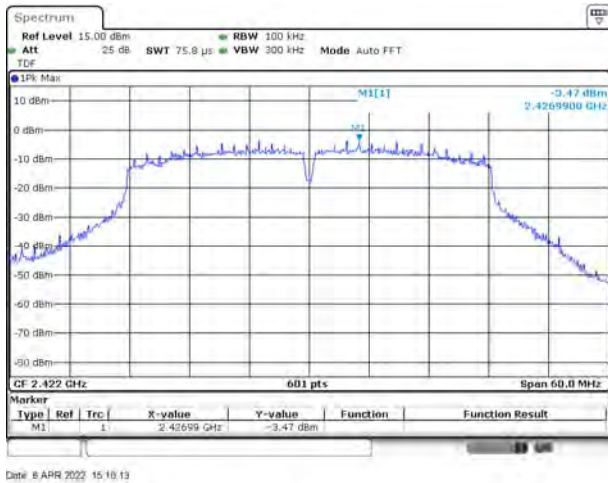

Date: 6 APR 2022 15:10:13

802.11n-40 MHz LOW CHANNEL, SPURIOUS
30 MHz ~ 3 GHz

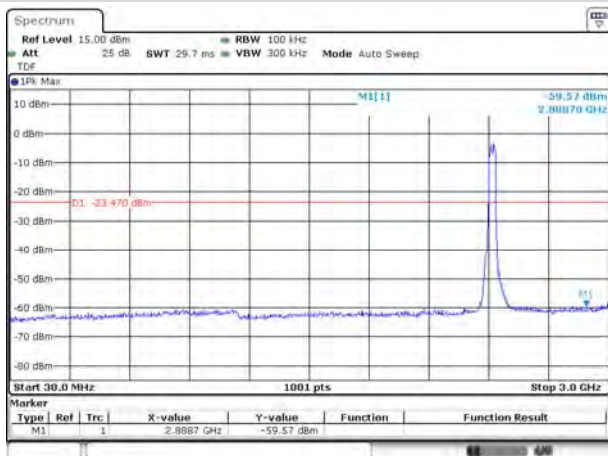

Date: 6 APR 2022 15:12:09

802.11n-40 MHz LOW CHANNEL, SPURIOUS
2 GHz ~ 25 GHz

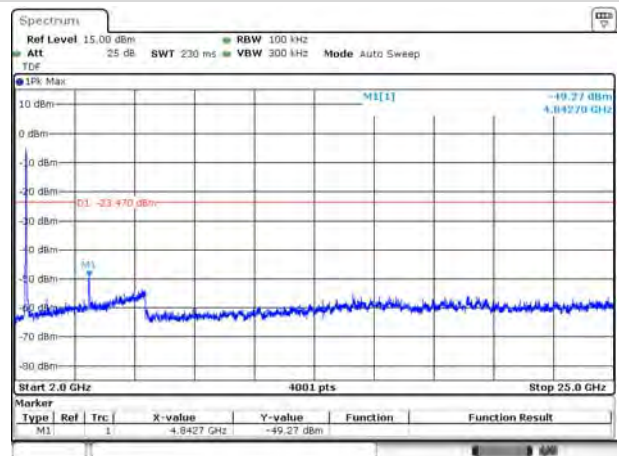

Date: 6 APR 2022 15:12:32

802.11n-40 MHz MIDDLE CHANNEL CARRIER LEVEL

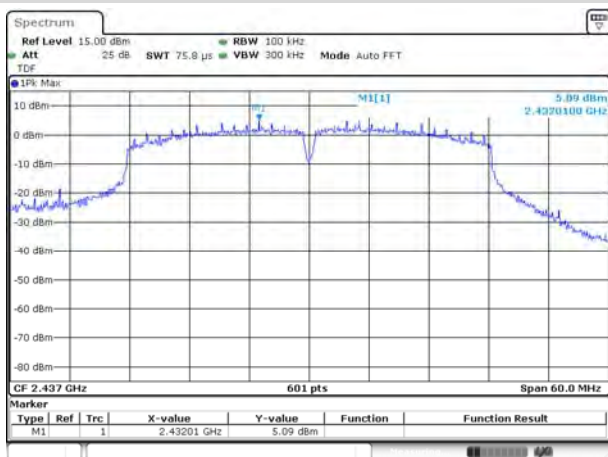

Date: 6 APR 2022 15:18:54

802.11n-40 MHz MIDDLE CHANNEL, SPURIOUS
30 MHz ~ 3 GHz

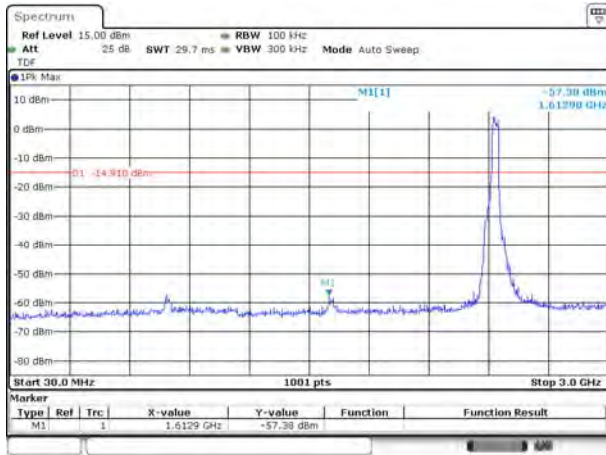

Date: 6 APR 2022 15:19:25

802.11n-40 MHz MIDDLE CHANNEL, SPURIOUS
2 GHz ~ 25 GHz

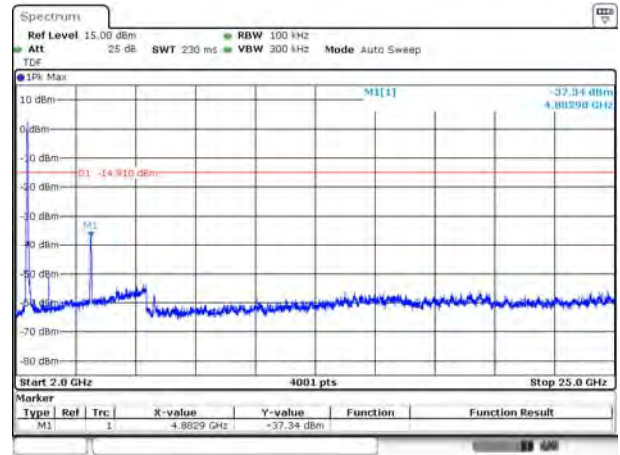

Date: 6 APR 2022 15:19:40

802.11n-40 MHz HIGH CHANNEL CARRIER LEVEL

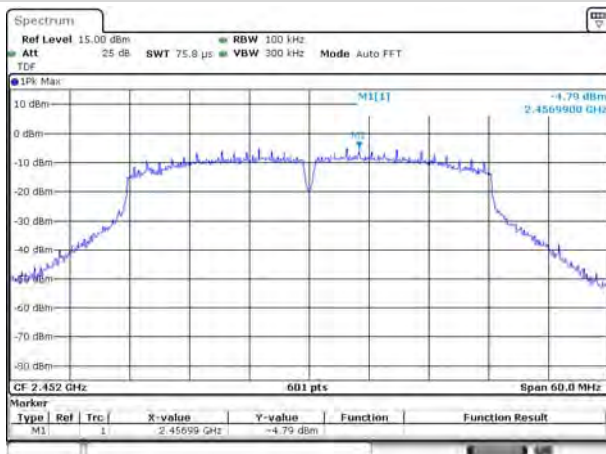

Date: 6 APR 2022 15:21:32

802.11n-40 MHz HIGH CHANNEL, SPURIOUS
30 MHz ~ 3 GHz

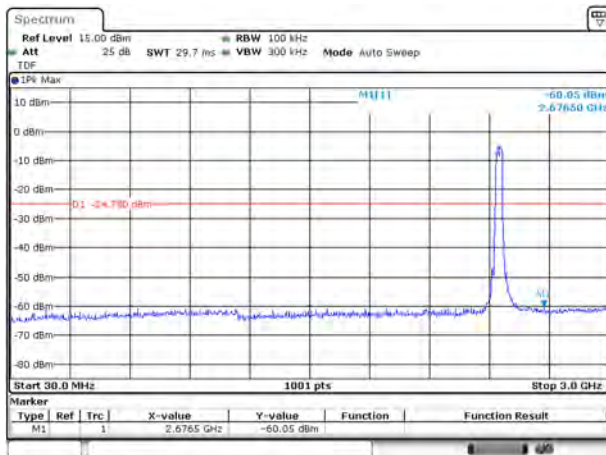

Date: 6 APR 2022 15:22:16

802.11n-40 MHz HIGH CHANNEL, SPURIOUS
2 GHz ~ 25 GHz

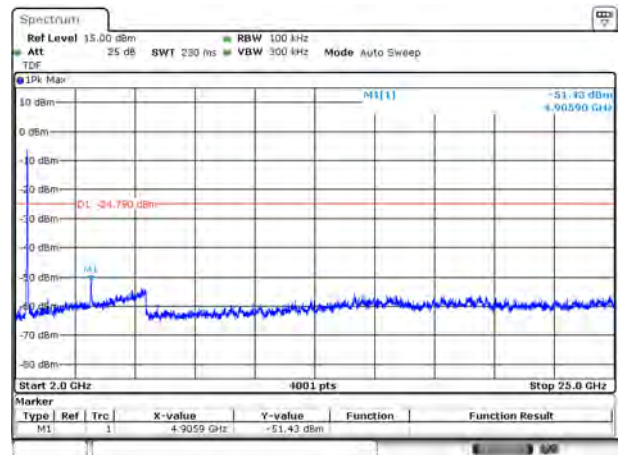

Date: 6 APR 2022 15:22:37

Aux. Antenna

802.11b LOW CHANNEL CARRIER LEVEL

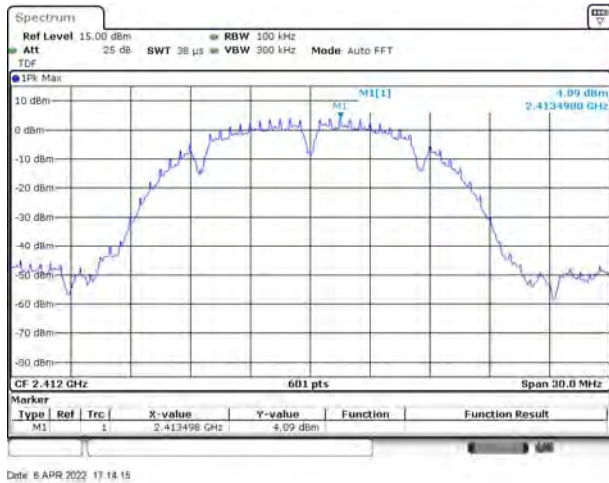

Date: 6 APR 2022 17:18:15

802.11b LOW CHANNEL, SPURIOUS 30 MHz ~ 3 GHz

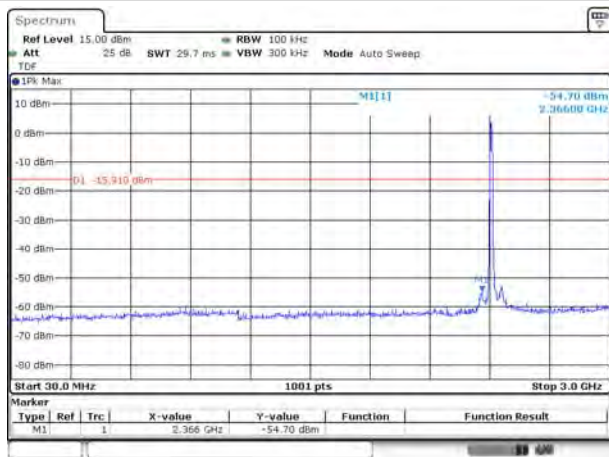

Date: 6 APR 2022 17:15:24

802.11b LOW CHANNEL, SPURIOUS 2 GHz ~ 25 GHz

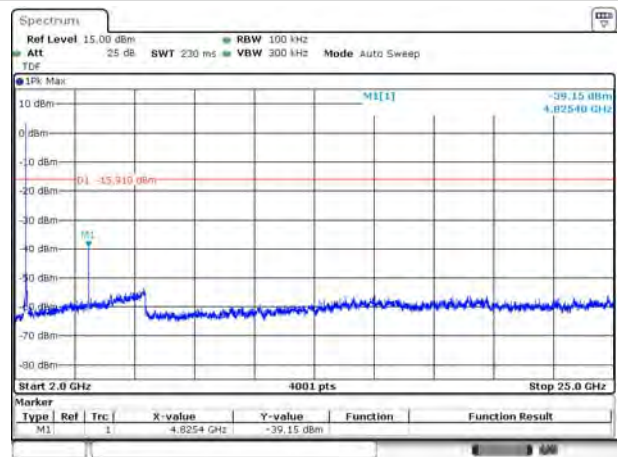

Date: 6 APR 2022 17:15:42

802.11b MIDDLE CHANNEL CARRIER LEVEL

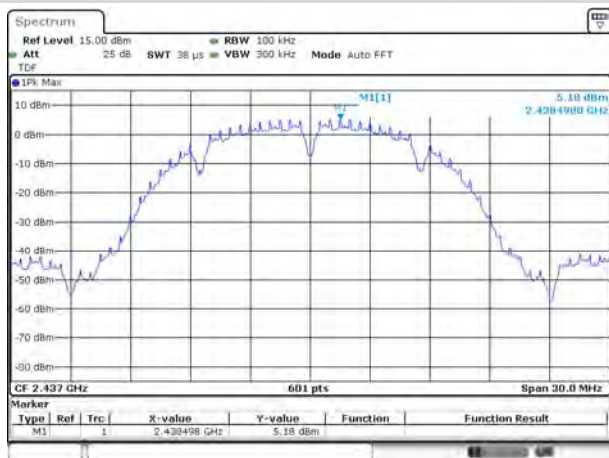

Date: 6 APR 2022 17:17:50

802.11b MIDDLE CHANNEL, SPURIOUS
30 MHz ~ 3 GHz

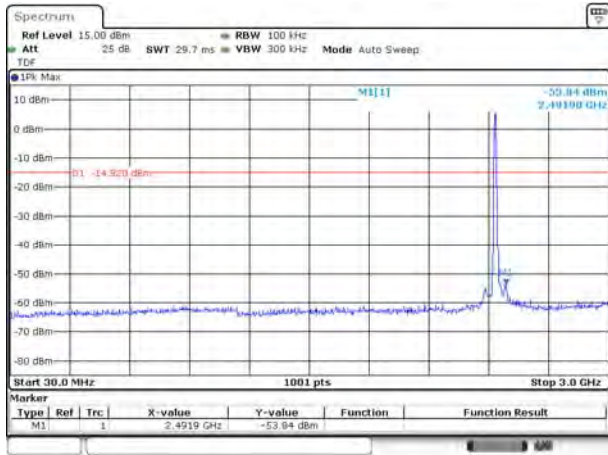

Date: 6 APR 2022 17:18:37

802.11b MIDDLE CHANNEL, SPURIOUS
2 GHz ~ 25 GHz

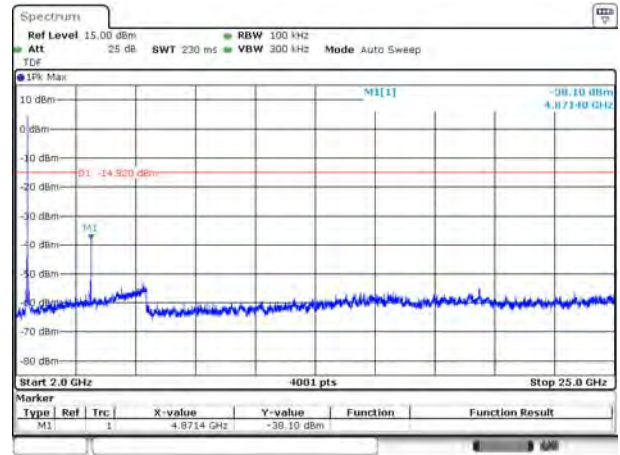

Date: 6 APR 2022 17:18:52

802.11b HIGH CHANNEL CARRIER LEVEL

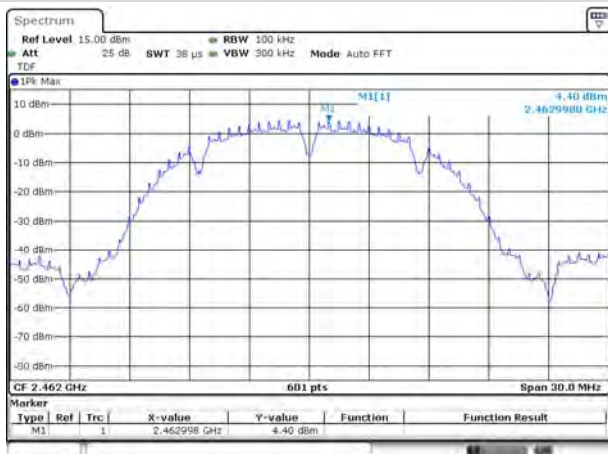

Date: 6 APR 2022 17:20:25

802.11b HIGH CHANNEL, SPURIOUS
30 MHz ~ 3 GHz

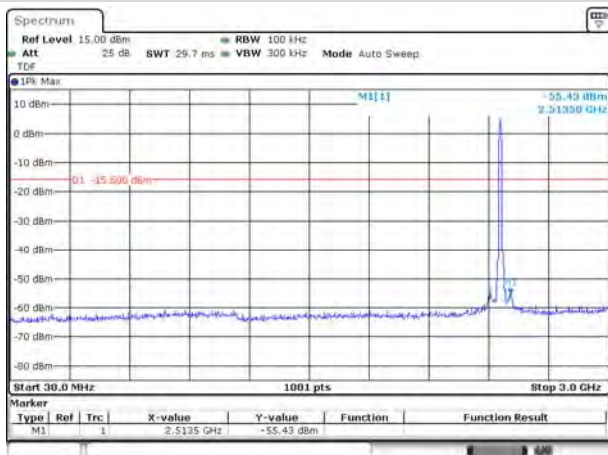

Date: 6 APR 2022 17:21:06

802.11b HIGH CHANNEL, SPURIOUS
2 GHz ~ 25 GHz

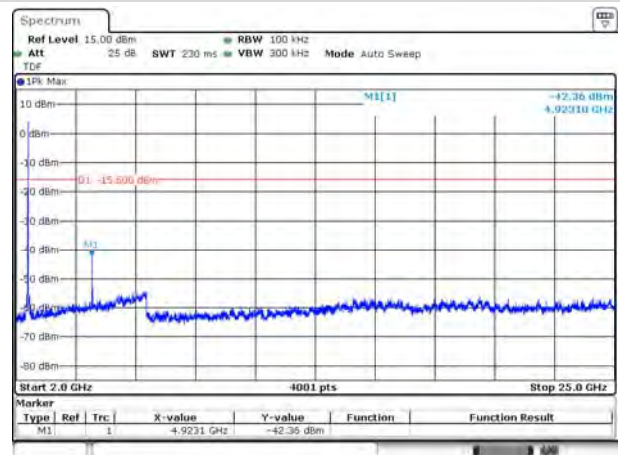

Date: 6 APR 2022 17:21:20

802.11g LOW CHANNEL CARRIER LEVEL

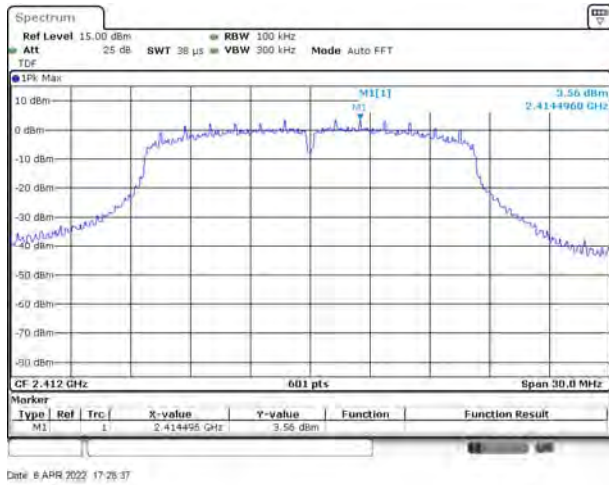

Date: 6 APR 2022 17:25:37

802.11g LOW CHANNEL, SPURIOUS 30 MHz ~ 3 GHz

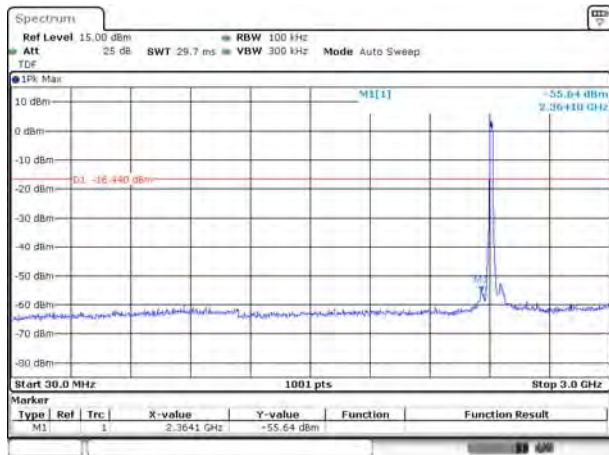

Date: 6 APR 2022 17:29:32

802.11g LOW CHANNEL, SPURIOUS 2 GHz ~ 25 GHz

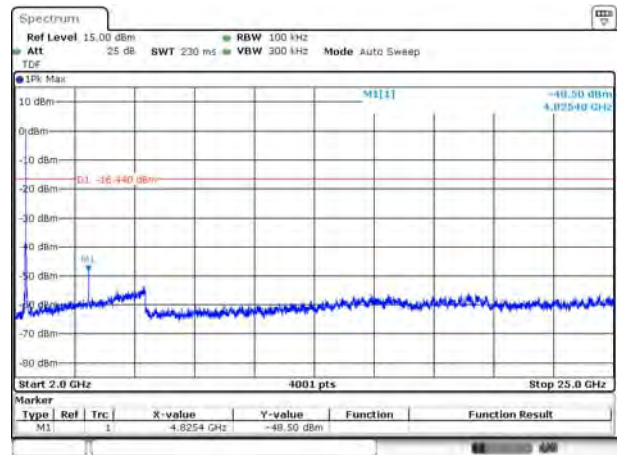

Date: 6 APR 2022 17:29:51

802.11g MIDDLE CHANNEL CARRIER LEVEL

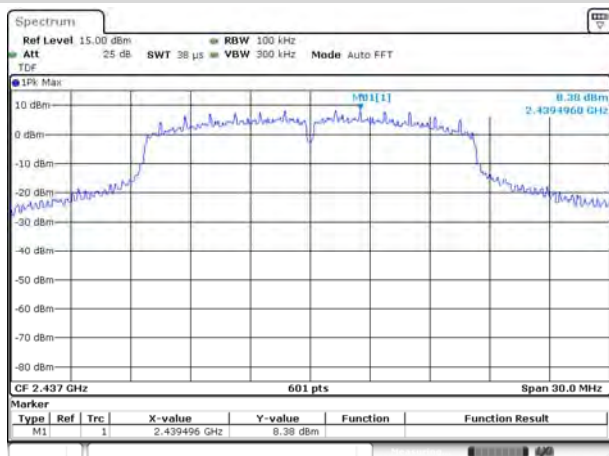

Date: 6 APR 2022 17:31:43

802.11g MIDDLE CHANNEL, SPURIOUS
30 MHz ~ 3 GHz

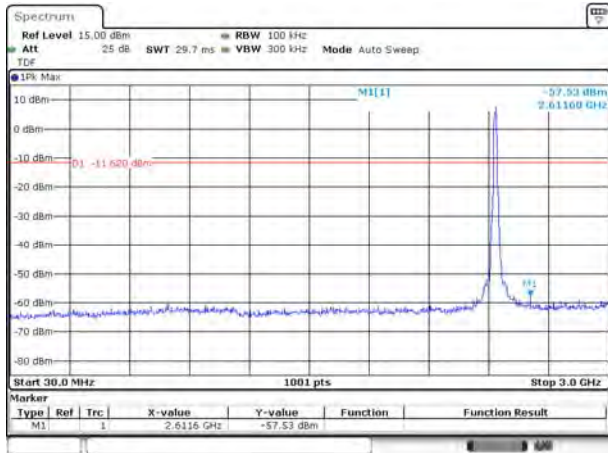

Date: 6 APR 2022 17:32:31

802.11g MIDDLE CHANNEL, SPURIOUS
2 GHz ~ 25 GHz

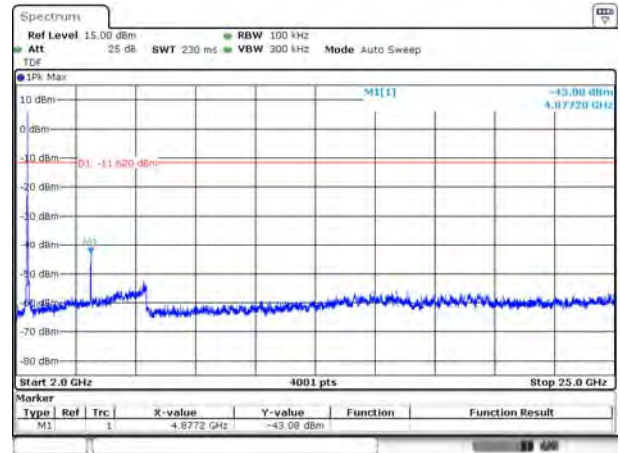

Date: 6 APR 2022 17:32:46

802.11g HIGH CHANNEL CARRIER LEVEL

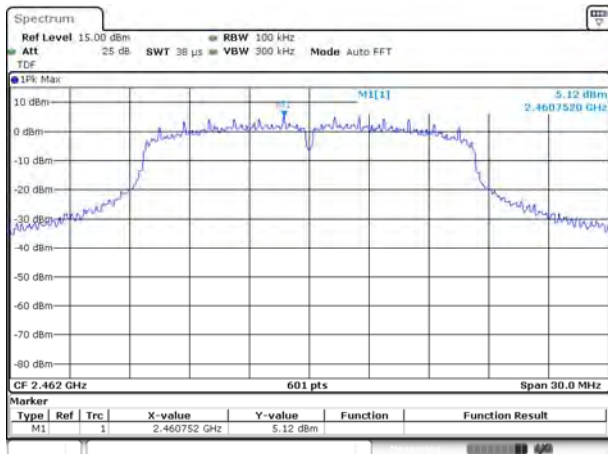

Date: 6 APR 2022 16:13:52

802.11g HIGH CHANNEL, SPURIOUS
30 MHz ~ 3 GHz

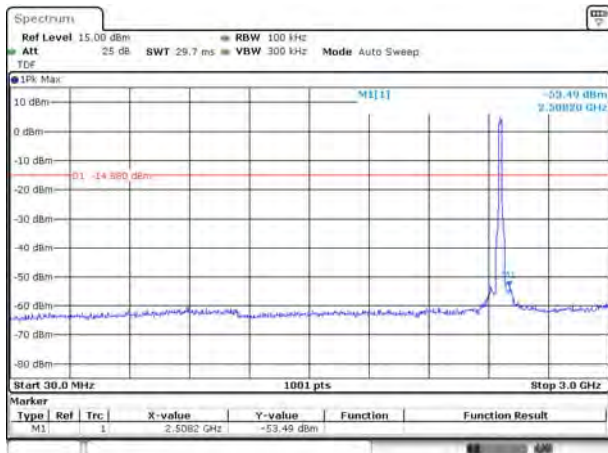

Date: 6 APR 2022 16:14:44

802.11g HIGH CHANNEL, SPURIOUS
2 GHz ~ 25 GHz

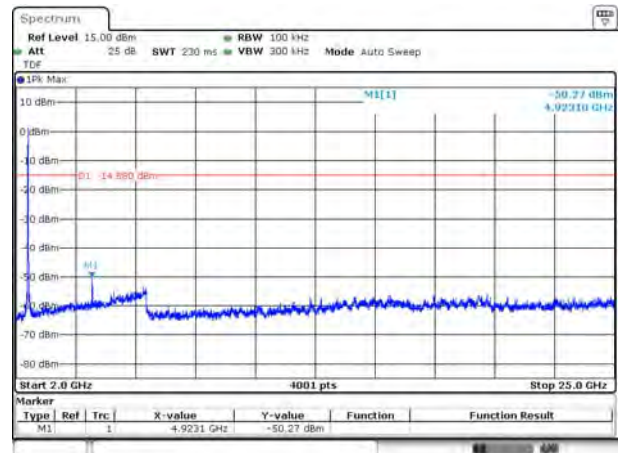

Date: 6 APR 2022 16:14:57

802.11n-20 MHz LOW CHANNEL CARRIER LEVEL

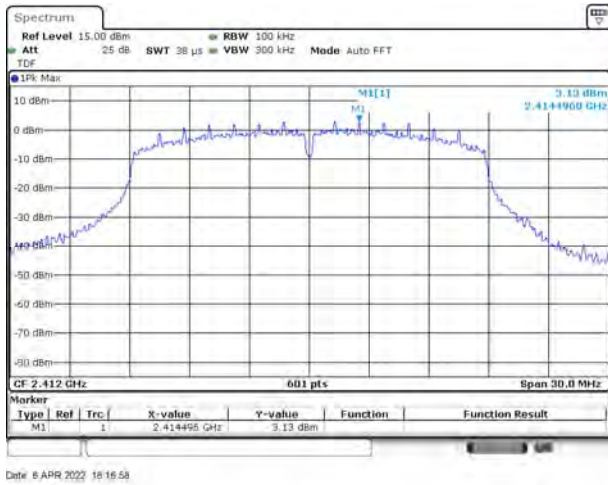

Date: 6 APR 2022 16:16:58

802.11n-20 MHz LOW CHANNEL, SPURIOUS
30 MHz ~ 3 GHz

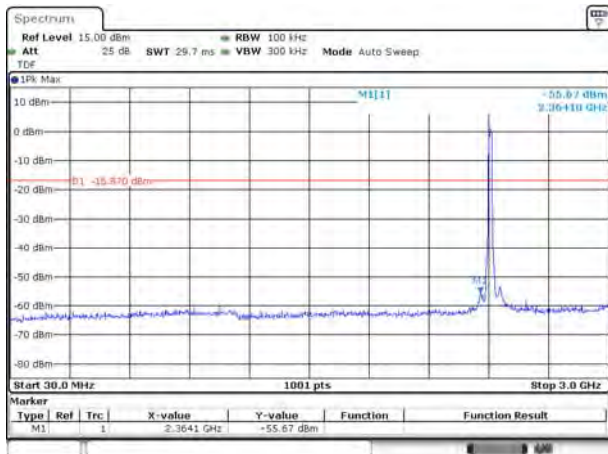

Date: 6 APR 2022 16:17:38

802.11n-20 MHz LOW CHANNEL, SPURIOUS
2 GHz ~ 25 GHz

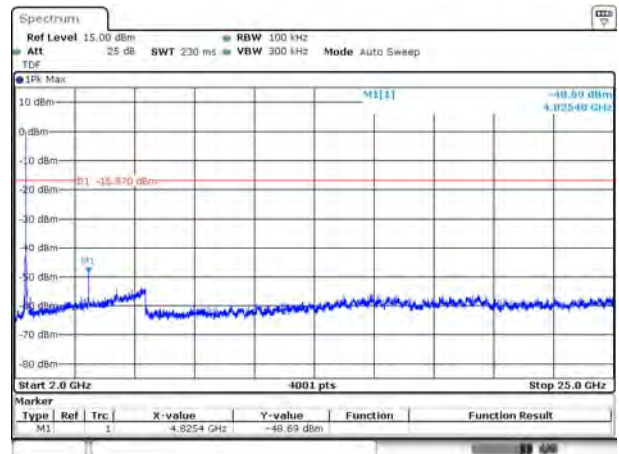

Date: 6 APR 2022 16:17:57

802.11n-20 MHz MIDDLE CHANNEL CARRIER LEVEL

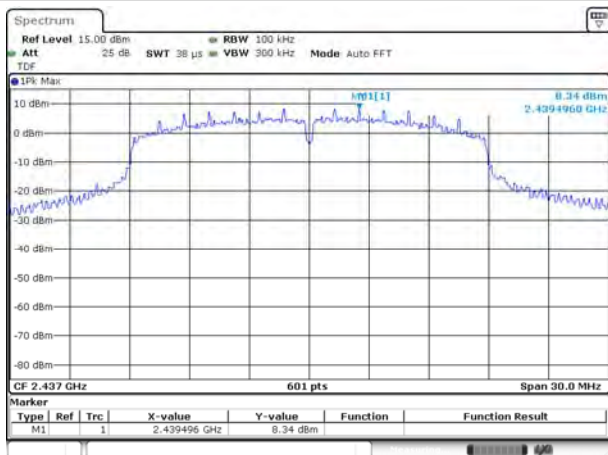

Date: 6 APR 2022 18:19:54

802.11n-20 MHz MIDDLE CHANNEL, SPURIOUS
30 MHz ~ 3 GHz

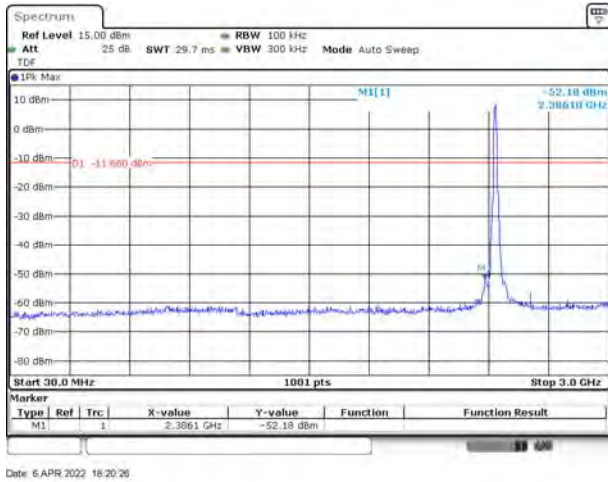

802.11n-20 MHz MIDDLE CHANNEL, SPURIOUS
2 GHz ~ 25 GHz

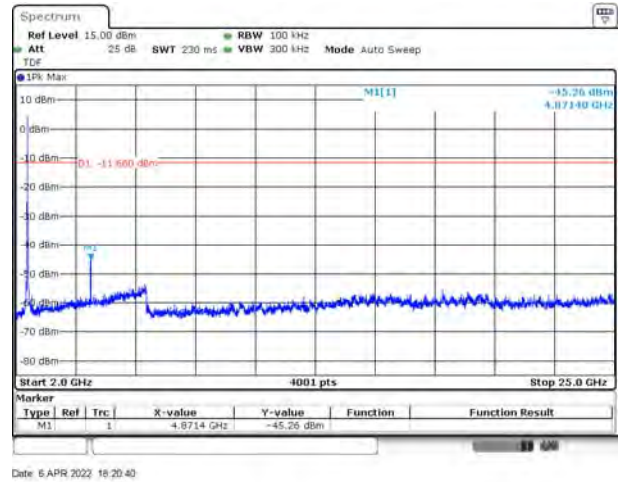

802.11n-20 MHz HIGH CHANNEL CARRIER LEVEL

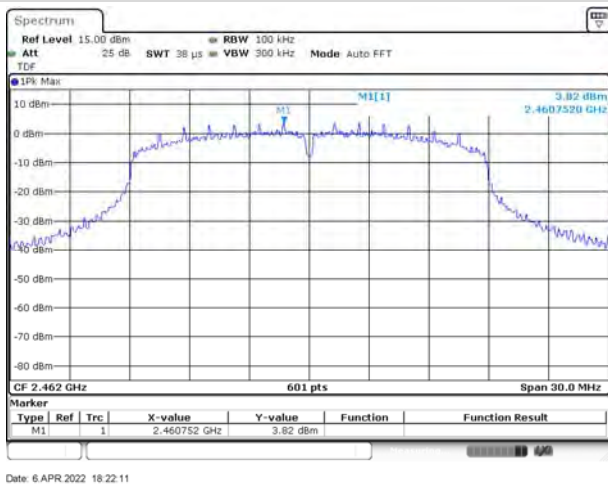

802.11n-20 MHz HIGH CHANNEL, SPURIOUS
30 MHz ~ 3 GHz

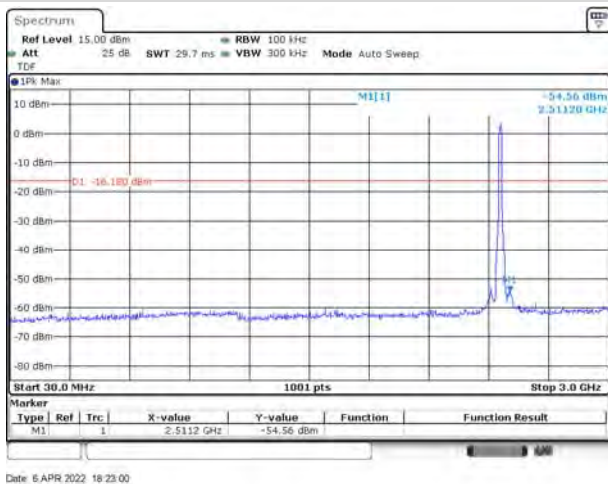

802.11n-20 MHz HIGH CHANNEL, SPURIOUS
2 GHz ~ 25 GHz

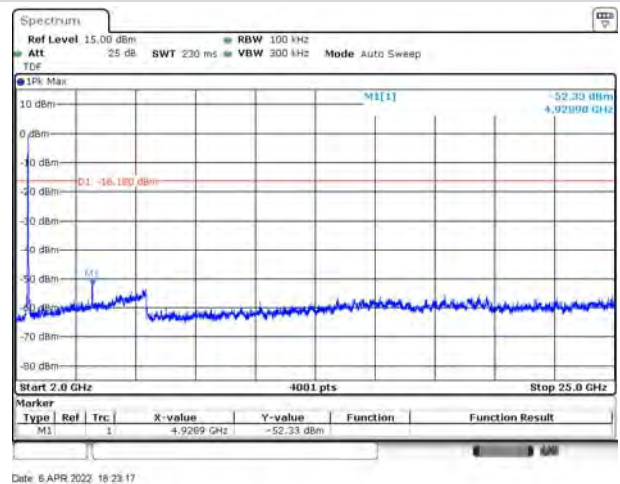

802.11n-40 MHz LOW CHANNEL CARRIER LEVEL

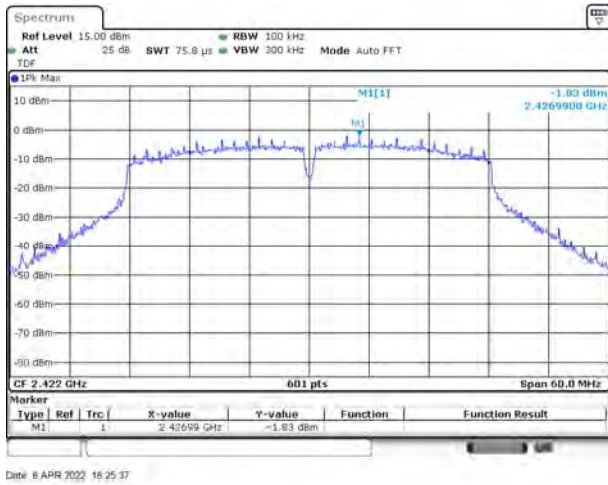

Date: 6 APR 2022 16:25:37

802.11n-40 MHz LOW CHANNEL, SPURIOUS
30 MHz ~ 3 GHz

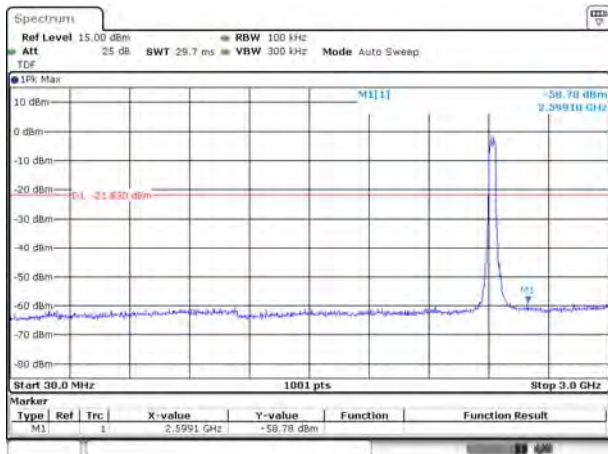

Date: 6 APR 2022 16:26:32

802.11n-40 MHz LOW CHANNEL, SPURIOUS
2 GHz ~ 25 GHz

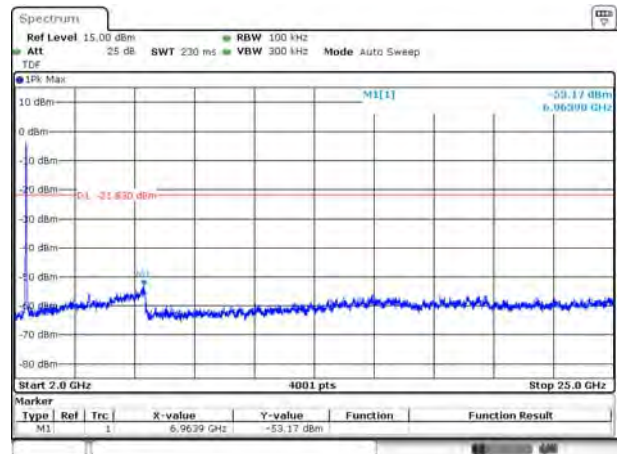

Date: 6 APR 2022 16:26:47

802.11n-40 MHz MIDDLE CHANNEL CARRIER LEVEL

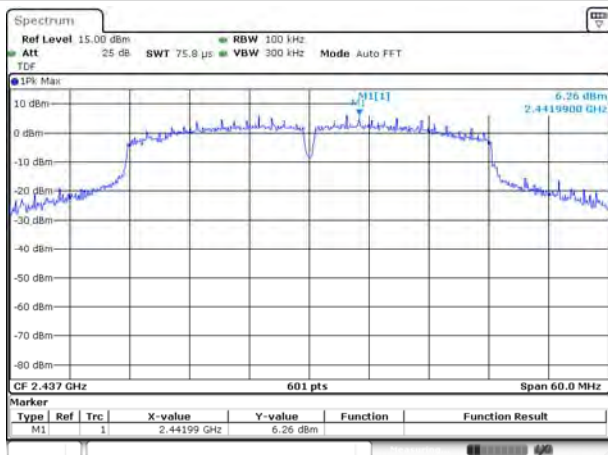

Date: 6 APR 2022 18:30:49

802.11n-40 MHz MIDDLE CHANNEL, SPURIOUS
30 MHz ~ 3 GHz

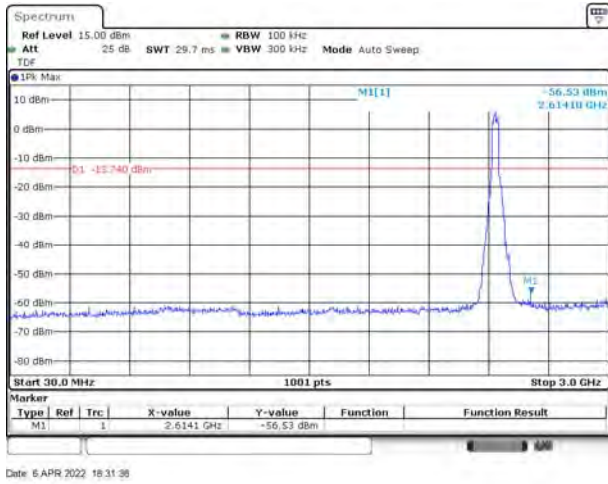

802.11n-40 MHz MIDDLE CHANNEL, SPURIOUS
2 GHz ~ 25 GHz

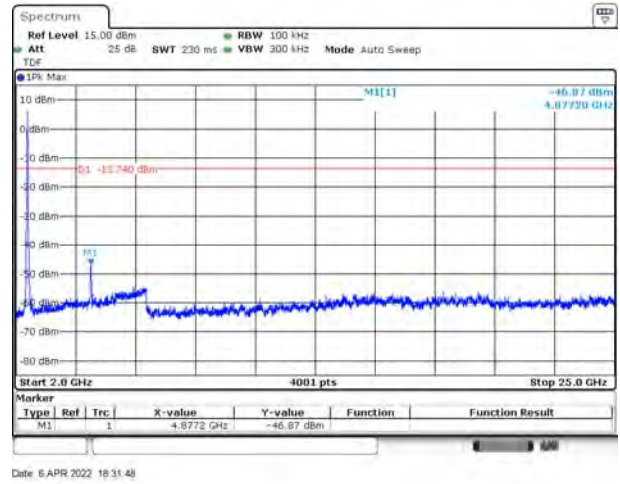

802.11n-40 MHz HIGH CHANNEL CARRIER LEVEL

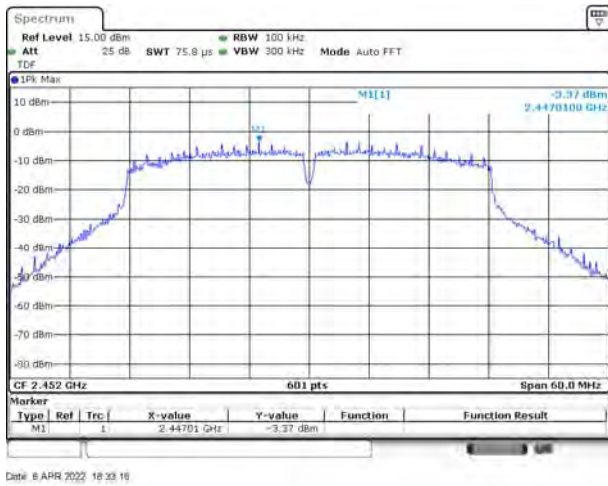

802.11n-40 MHz HIGH CHANNEL, SPURIOUS
30 MHz ~ 3 GHz

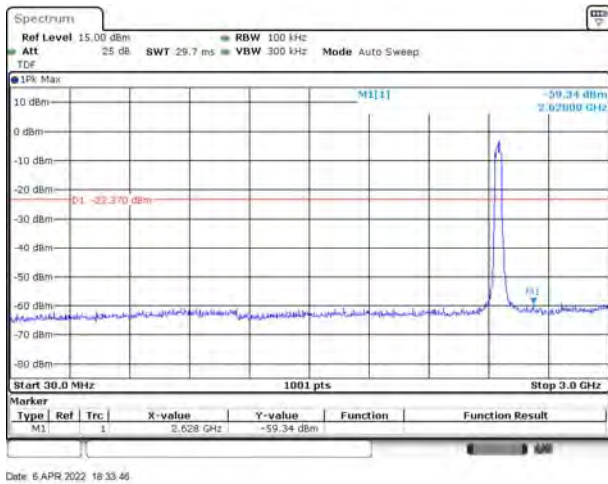

802.11n-40 MHz HIGH CHANNEL, SPURIOUS
2 GHz ~ 25 GHz

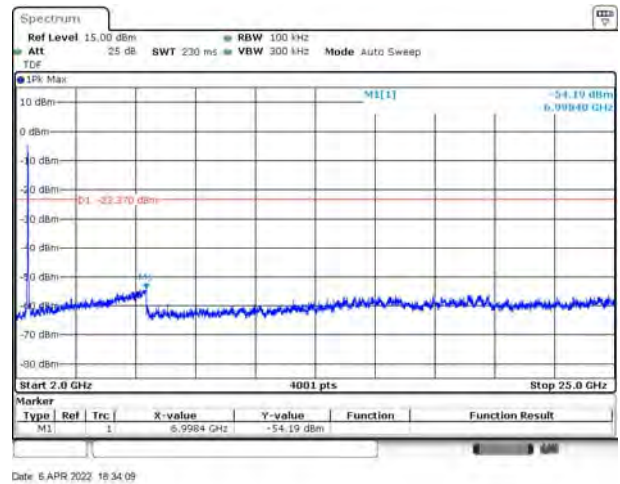

MIMO-Main Antenna

802.11n-20 MHz LOW CHANNEL CARRIER LEVEL

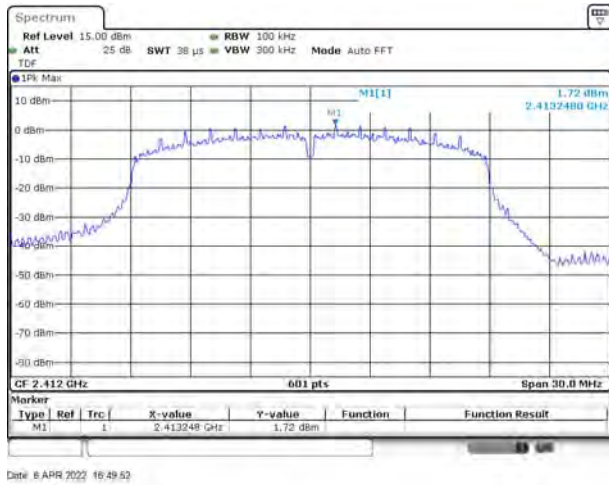

Date: 6 APR 2022 16:49:53

802.11n-20 MHz LOW CHANNEL, SPURIOUS
30 MHz ~ 3 GHz

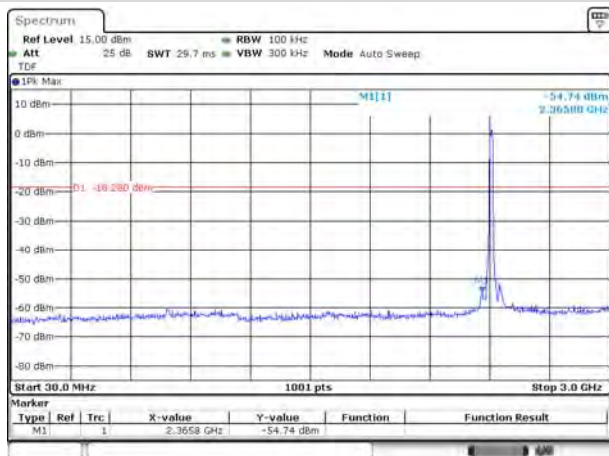

Date: 6 APR 2022 16:50:43

802.11n-20 MHz LOW CHANNEL, SPURIOUS
2 GHz ~ 25 GHz

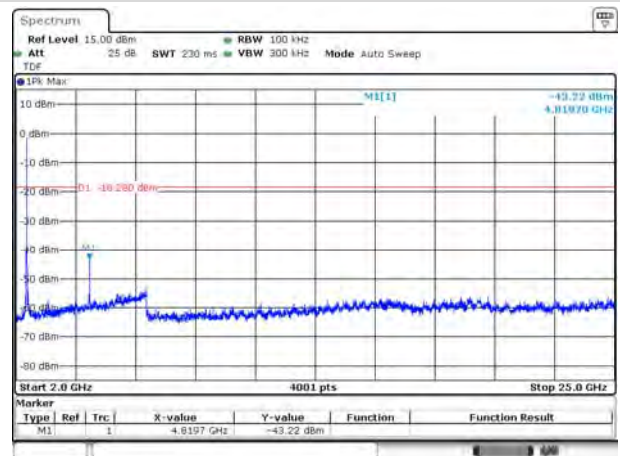

Date: 6 APR 2022 16:51:13

802.11n-20 MHz MIDDLE CHANNEL CARRIER LEVEL

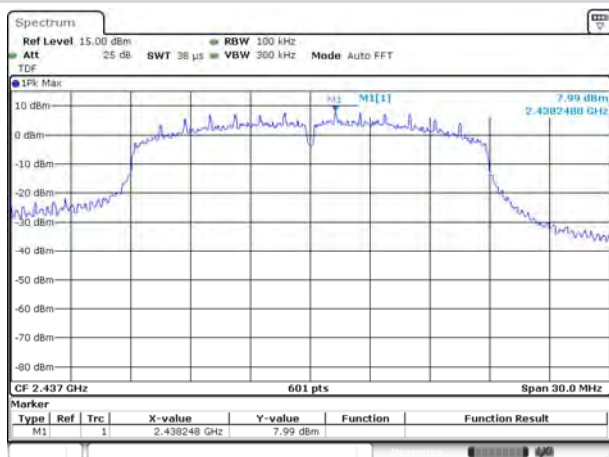

Date: 6 APR 2022 16:55:29

802.11n-20 MHz MIDDLE CHANNEL, SPURIOUS
30 MHz ~ 3 GHz

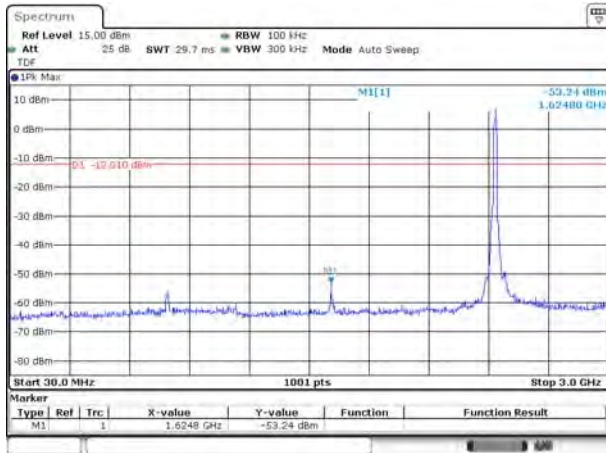

Date: 6 APR 2022 16:55:57

802.11n-20 MHz MIDDLE CHANNEL, SPURIOUS
2 GHz ~ 25 GHz

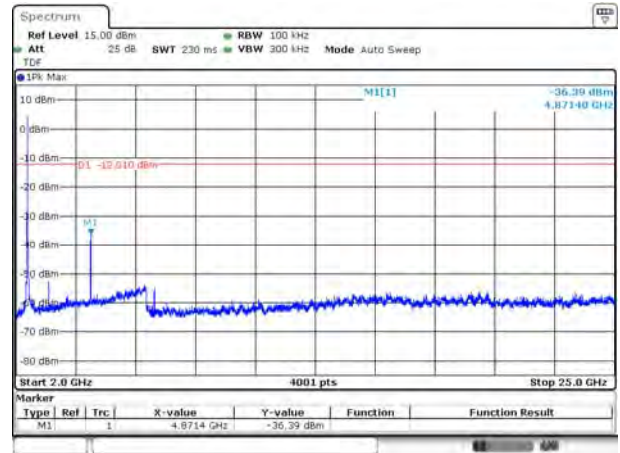

Date: 6 APR 2022 16:56:43

802.11n-20 MHz HIGH CHANNEL CARRIER LEVEL

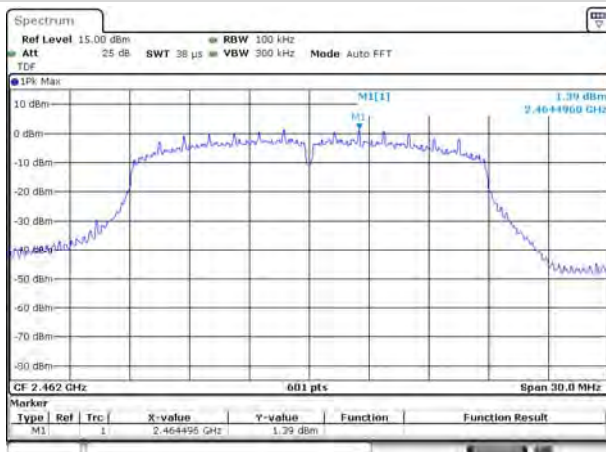

Date: 6 APR 2022 16:58:28

802.11n-20 MHz HIGH CHANNEL, SPURIOUS
30 MHz ~ 3 GHz

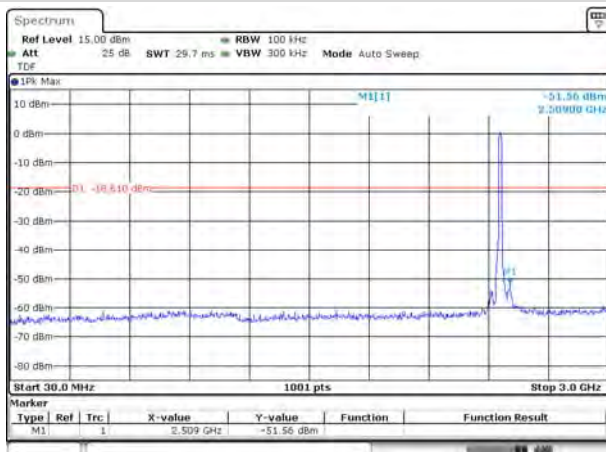

Date: 6 APR 2022 16:59:26

802.11n-20 MHz HIGH CHANNEL, SPURIOUS
2 GHz ~ 25 GHz

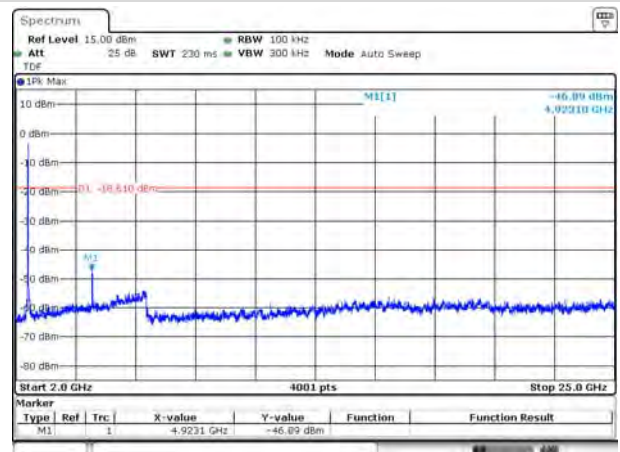

Date: 6 APR 2022 16:59:44

802.11n-40 MHz LOW CHANNEL CARRIER LEVEL

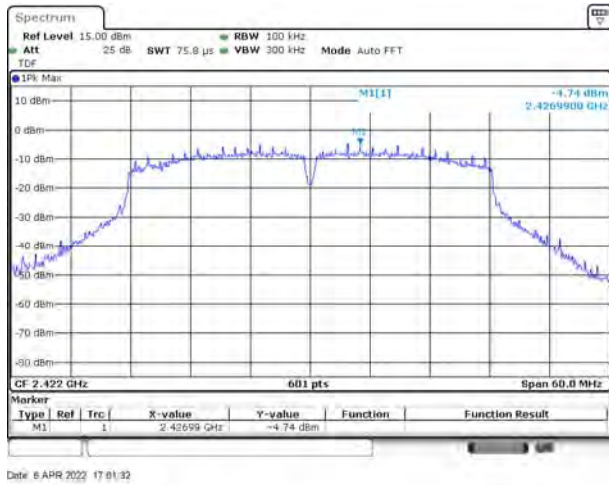

Date: 6 APR 2022 17:01:32

802.11n-40 MHz LOW CHANNEL, SPURIOUS
30 MHz ~ 3 GHz

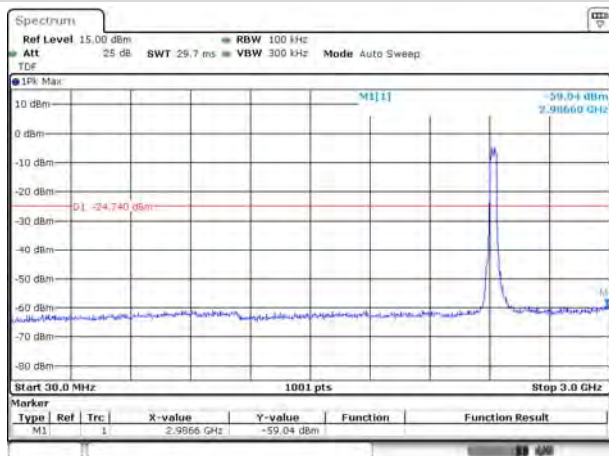

Date: 6 APR 2022 17:02:20

802.11n-40 MHz LOW CHANNEL, SPURIOUS
2 GHz ~ 25 GHz

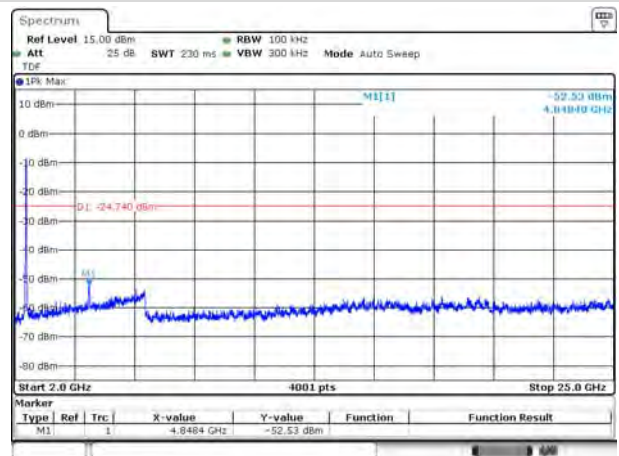

Date: 6 APR 2022 17:02:34

802.11n-40 MHz MIDDLE CHANNEL CARRIER LEVEL

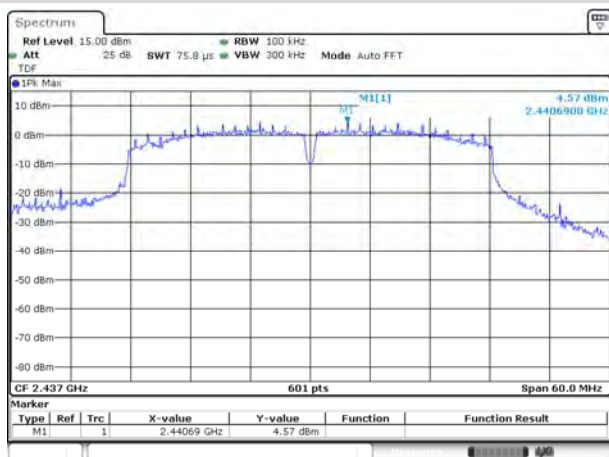

Date: 6 APR 2022 17:04:16

802.11n-40 MHz MIDDLE CHANNEL, SPURIOUS
30 MHz ~ 3 GHz

802.11n-40 MHz MIDDLE CHANNEL, SPURIOUS
2 GHz ~ 25 GHz

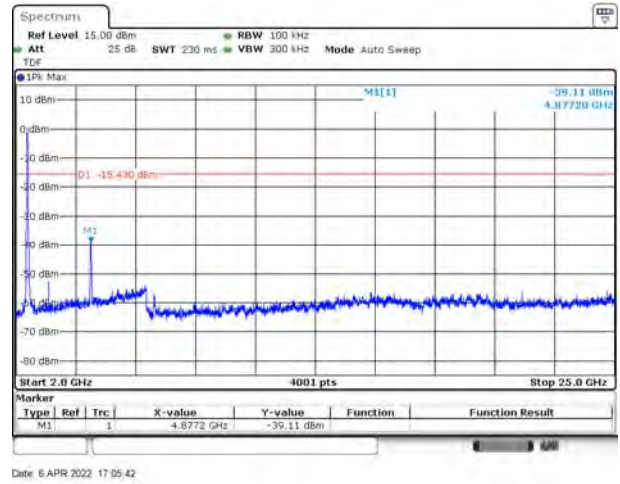
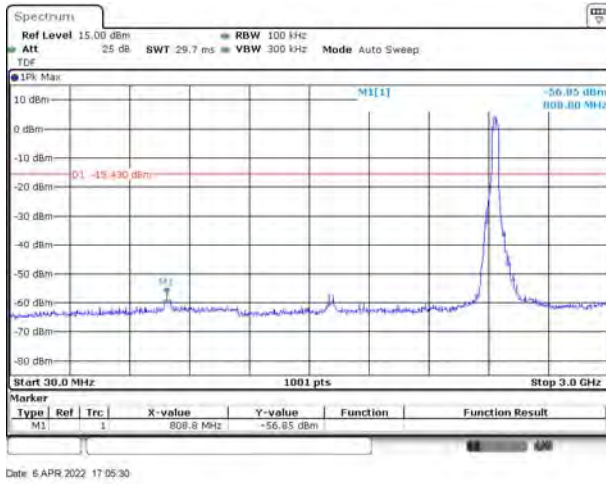

802.11n-40 MHz HIGH CHANNEL CARRIER LEVEL

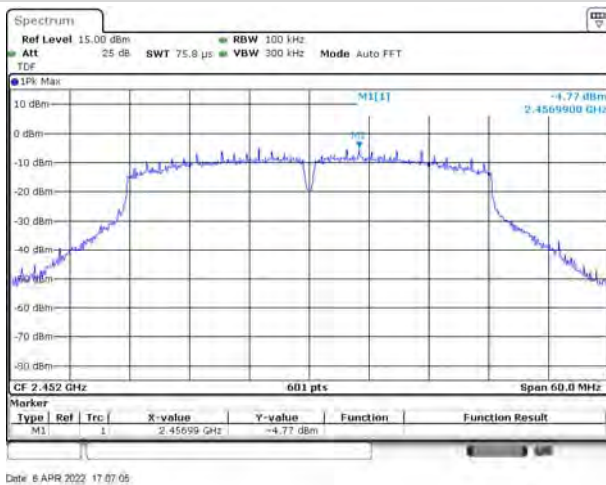

802.11n-40 MHz HIGH CHANNEL, SPURIOUS
30 MHz ~ 3 GHz

802.11n-40 MHz HIGH CHANNEL, SPURIOUS
2 GHz ~ 25 GHz

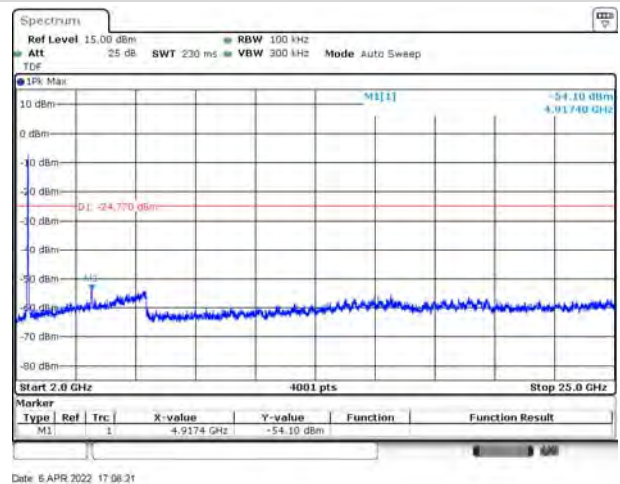
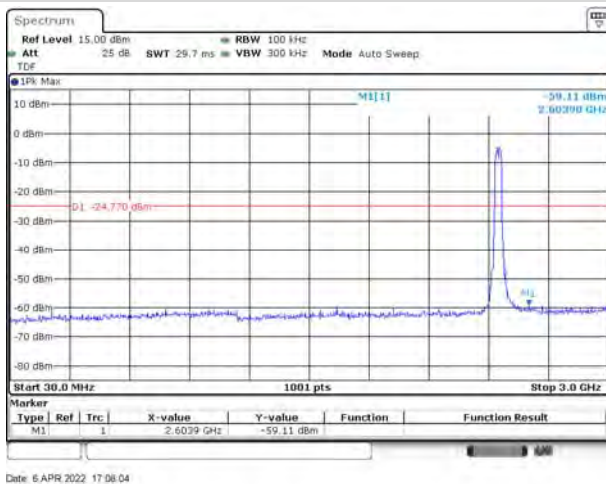

MIMO-Aux. Antenna

802.11n-20 MHz LOW CHANNEL CARRIER LEVEL

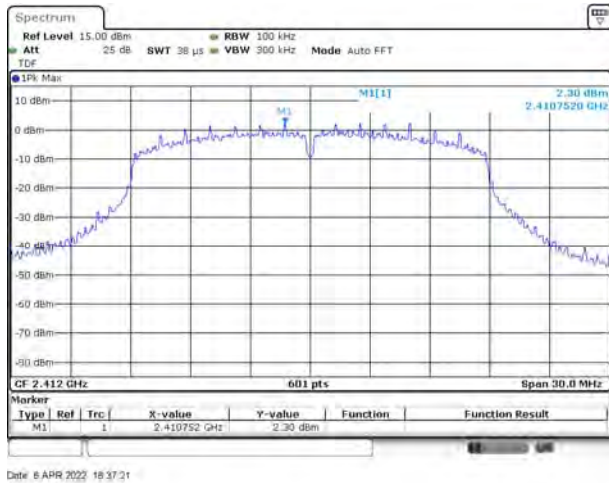

802.11n-20 MHz LOW CHANNEL, SPURIOUS
30 MHz ~ 3 GHz

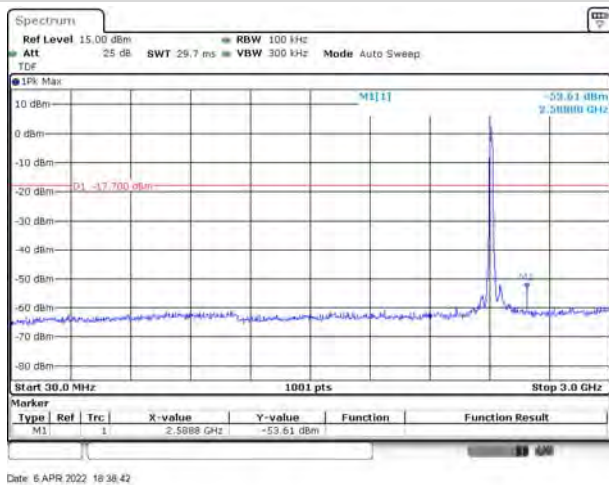

802.11n-20 MHz LOW CHANNEL, SPURIOUS
2 GHz ~ 25 GHz

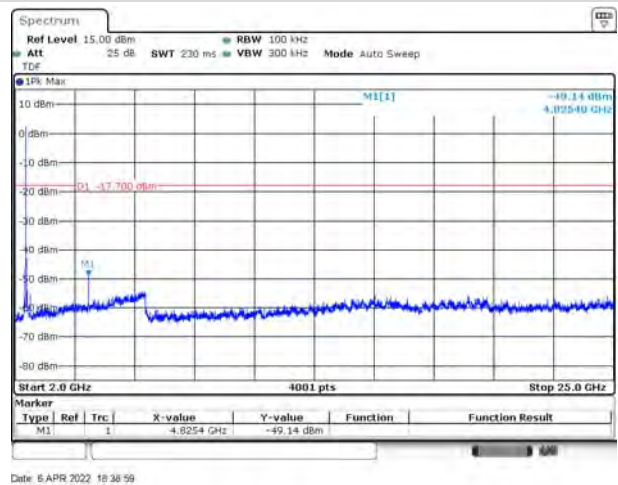

802.11n-20 MHz MIDDLE CHANNEL CARRIER LEVEL

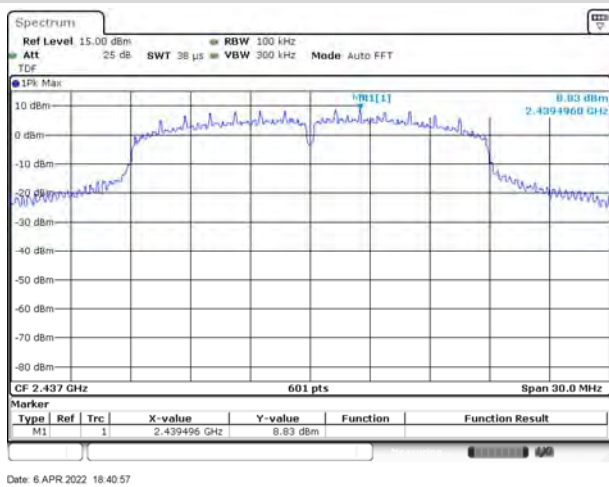

802.11n-20 MHz MIDDLE CHANNEL, SPURIOUS
30 MHz ~ 3 GHz

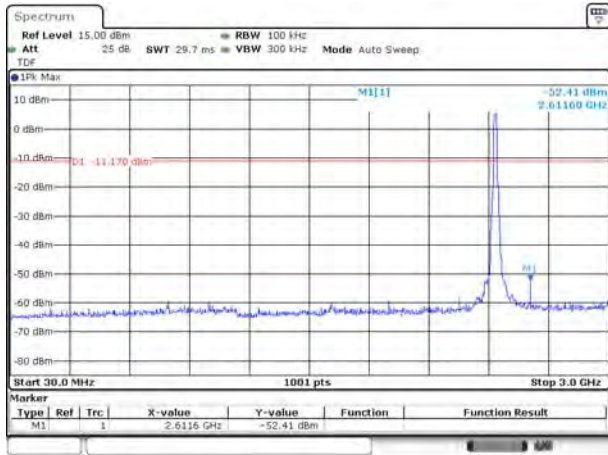

Date: 6 APR 2022 16:41:38

802.11n-20 MHz MIDDLE CHANNEL, SPURIOUS
2 GHz ~ 25 GHz

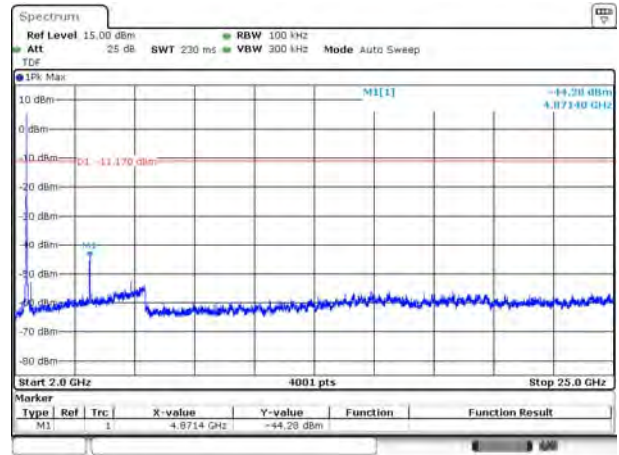

Date: 6 APR 2022 16:41:53

802.11n-20 MHz HIGH CHANNEL CARRIER LEVEL

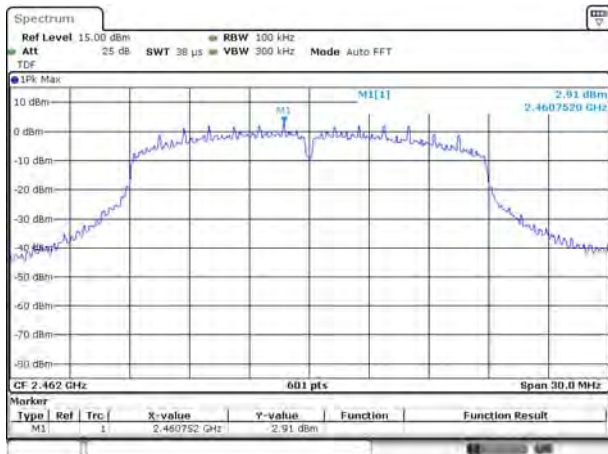

Date: 6 APR 2022 16:43:16

802.11n-20 MHz HIGH CHANNEL, SPURIOUS
30 MHz ~ 3 GHz

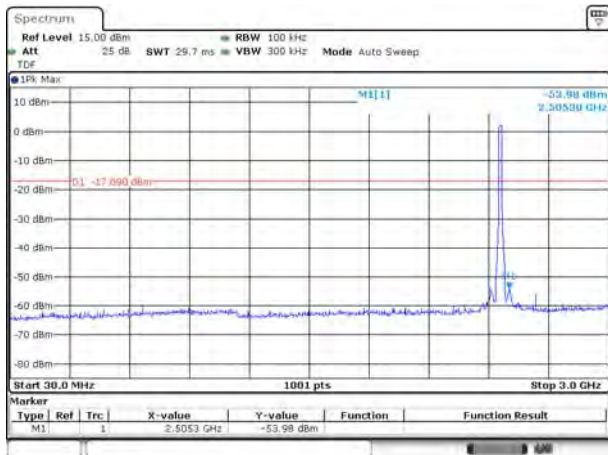

Date: 6 APR 2022 16:44:19

802.11n-20 MHz HIGH CHANNEL, SPURIOUS
2 GHz ~ 25 GHz

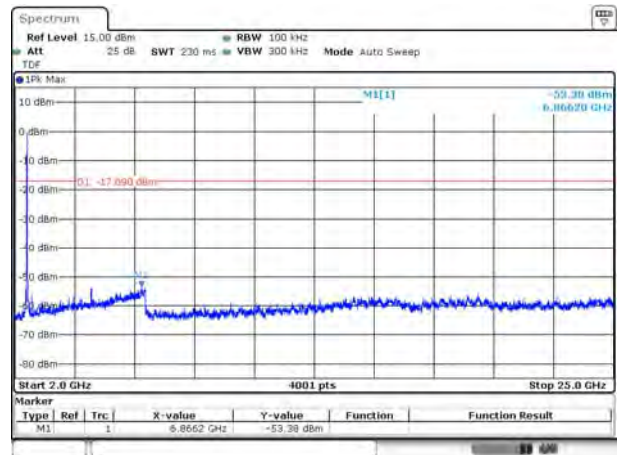

Date: 6 APR 2022 16:44:43

802.11n-40 MHz LOW CHANNEL CARRIER LEVEL

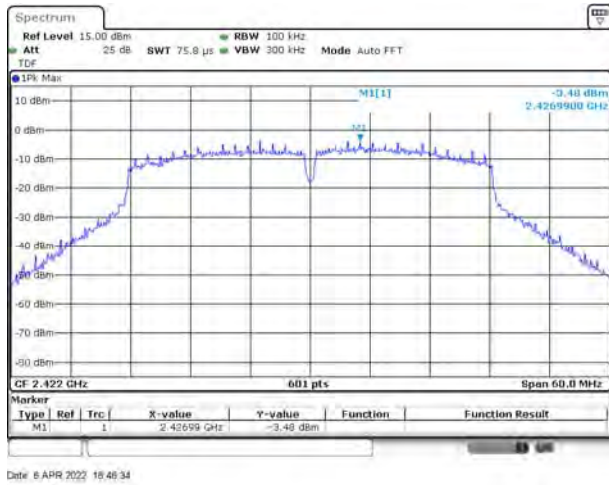

Date: 6 APR 2022 16:46:34

802.11n-40 MHz LOW CHANNEL, SPURIOUS
30 MHz ~ 3 GHz

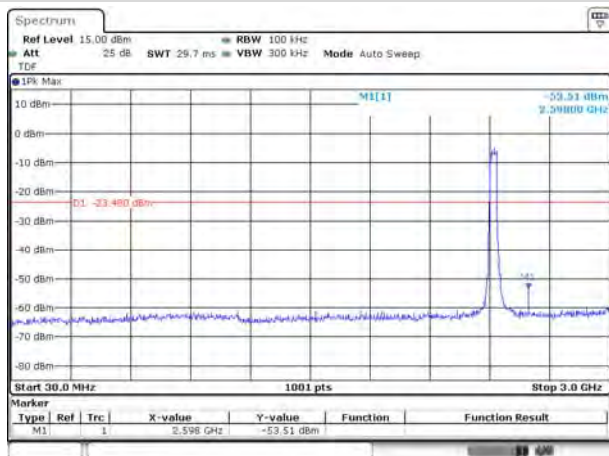

Date: 6 APR 2022 16:47:01

802.11n-40 MHz LOW CHANNEL, SPURIOUS
2 GHz ~ 25 GHz

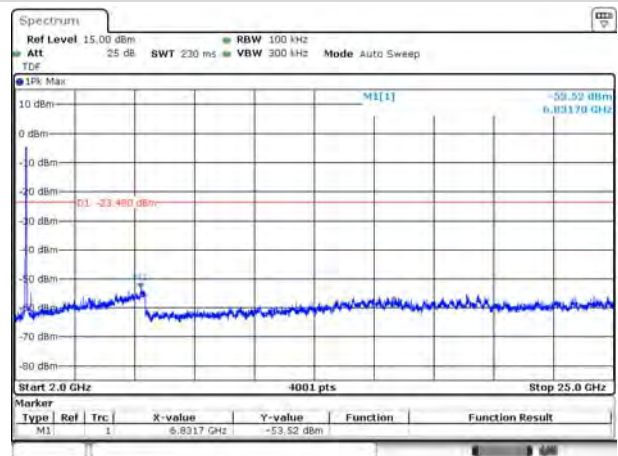

Date: 6 APR 2022 16:47:27

802.11n-40 MHz MIDDLE CHANNEL CARRIER LEVEL

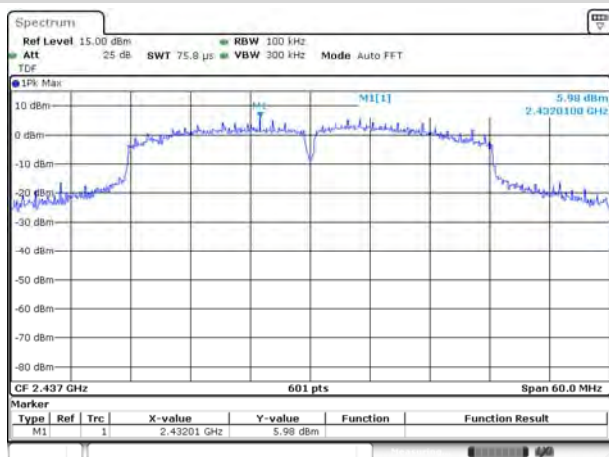

Date: 6 APR 2022 16:49:08

802.11n-40 MHz MIDDLE CHANNEL, SPURIOUS
30 MHz ~ 3 GHz

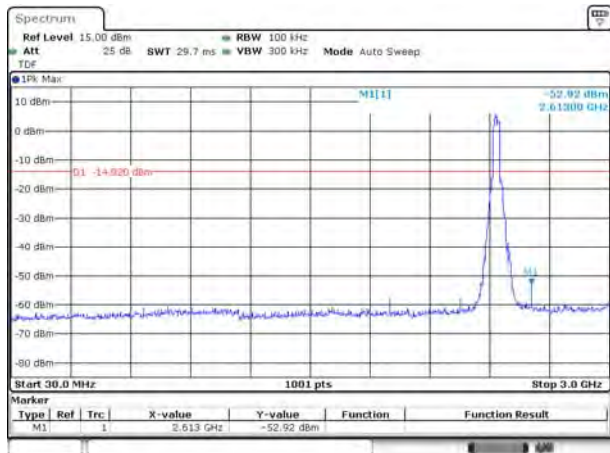

Date: 6 APR 2022 18:49:37

802.11n-40 MHz MIDDLE CHANNEL, SPURIOUS
2 GHz ~ 25 GHz

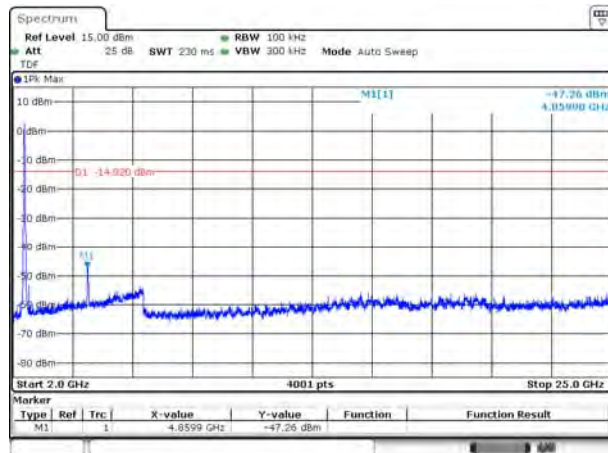

Date: 6 APR 2022 18:49:59

802.11n-40 MHz HIGH CHANNEL CARRIER LEVEL

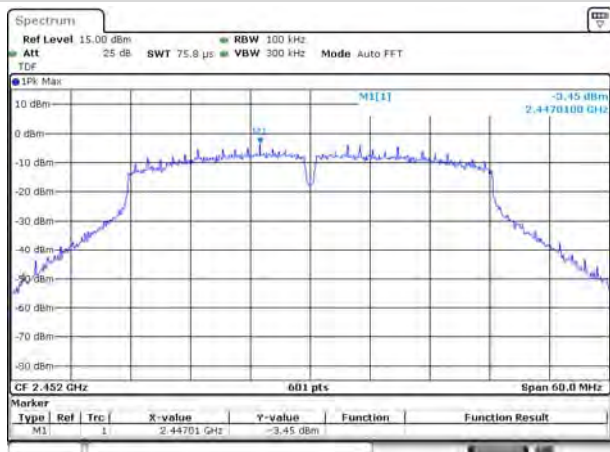

Date: 6 APR 2022 18:51:21

802.11n-40 MHz HIGH CHANNEL, SPURIOUS
30 MHz ~ 3 GHz

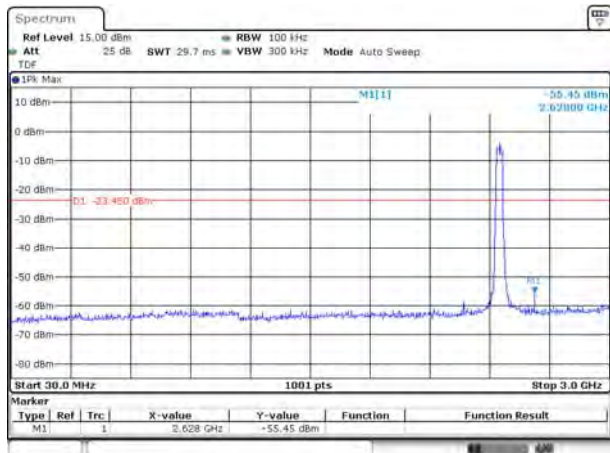

Date: 6 APR 2022 18:51:46

802.11n-40 MHz HIGH CHANNEL, SPURIOUS
2 GHz ~ 25 GHz

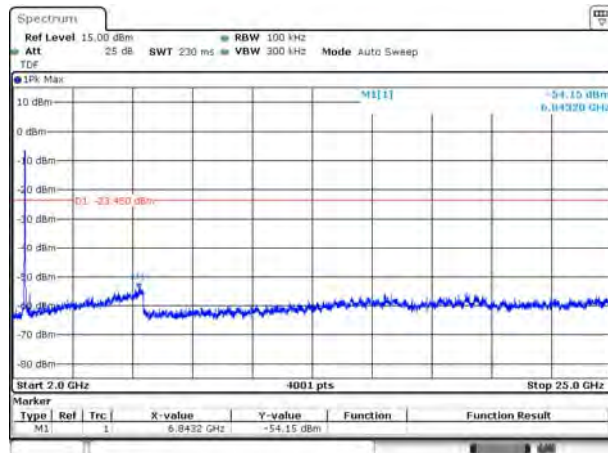

Date: 6 APR 2022 18:52:06

A.4 Band Edge (Authorized-band band-edge)

Note: The 99% OBW of the fundamental emission is without 2 MHz of the authorized band.

Test Data

Main Antenna

802.11b Mode:

Channel	Measured Max. Band Edge Emission (dBm)	Limit (dBm)		Verdict
		Carrier Level	Calculated 20 dBc Limit	
Low Channel	-43.51	2.75	-17.25	Pass
High Channel	-47.95	3.00	-17.00	Pass

802.11g Mode:

Channel	Measured Max. Band Edge Emission (dBm)	Limit (dBm)		Verdict
		Carrier Level	Calculated 20 dBc Limit	
Low Channel	-32.92	2.69	-17.31	Pass
High Channel	-47.11	3.80	-16.20	Pass

802.11n-20 MHz Mode:

Channel	Measured Max. Band Edge Emission (dBm)	Limit (dBm)		Verdict
		Carrier Level	Calculated 20 dBc Limit	
Low Channel	-35.50	2.14	-17.86	Pass
High Channel	-47.12	2.75	-17.25	Pass

802.11n-40 MHz Mode:

Channel	Measured Max. Band Edge Emission (dBm)	Limit (dBm)		Verdict
		Carrier Level	Calculated 20 dBc Limit	
Low Channel	-35.92	-3.47	-23.47	Pass
High Channel	-47.01	-4.79	-24.79	Pass

Aux. Antenna

802.11b Mode:

Channel	Measured Max. Band Edge Emission (dBm)	Limit (dBm)		Verdict
		Carrier Level	Calculated 20 dBc Limit	
Low Channel	-45.71	4.09	-15.91	Pass
High Channel	-48.45	4.40	-15.60	Pass

802.11g Mode:

Channel	Measured Max. Band Edge Emission (dBm)	Limit (dBm)		Verdict
		Carrier Level	Calculated 20 dBc Limit	
Low Channel	-36.23	3.56	-16.44	Pass
High Channel	-44.61	5.12	-14.88	Pass

802.11n-20 MHz Mode:

Channel	Measured Max. Band Edge Emission (dBm)	Limit (dBm)		Verdict
		Carrier Level	Calculated 20 dBc Limit	
Low Channel	-37.99	3.13	-16.87	Pass
High Channel	-45.31	3.82	-16.18	Pass

802.11n-40 MHz Mode:

Channel	Measured Max. Band Edge Emission (dBm)	Limit (dBm)		Verdict
		Carrier Level	Calculated 20 dBc Limit	
Low Channel	-34.01	-1.83	-21.83	Pass
High Channel	-47.29	-3.37	-23.37	Pass

MIMO-Main Antenna

802.11n-20 MHz Mode:

Channel	Measured Max. Band Edge Emission (dBm)	Limit (dBm)		Verdict
		Carrier Level	Calculated 20 dBc Limit	
Low Channel	-37.87	1.72	-18.28	Pass
High Channel	-47.76	1.39	-18.61	Pass

802.11n-40 MHz Mode:

Channel	Measured Max. Band Edge Emission (dBm)	Limit (dBm)		Verdict
		Carrier Level	Calculated 20 dBc Limit	
Low Channel	-36.73	-4.74	-24.74	Pass
High Channel	-47.05	-4.77	-24.77	Pass

MIMO-Aux. Antenna

802.11n-20 MHz Mode:

Channel	Measured Max. Band Edge Emission (dBm)	Limit (dBm)		Verdict
		Carrier Level	Calculated 20 dBc Limit	
Low Channel	-39.70	2.30	-17.70	Pass
High Channel	-47.32	2.91	-17.09	Pass

802.11n-40 MHz Mode:

Channel	Measured Max. Band Edge Emission (dBm)	Limit (dBm)		Verdict
		Carrier Level	Calculated 20 dBc Limit	
Low Channel	-36.39	-3.48	-23.48	Pass
High Channel	-47.85	-3.45	-23.45	Pass

Test Plots

Main Antenna

802.11b LOW CHANNEL, CARRIER LEVEL



802.11b LOW CHANNEL, REFERENCE LEVEL



802.11b LOW CHANNEL, BAND EDGE

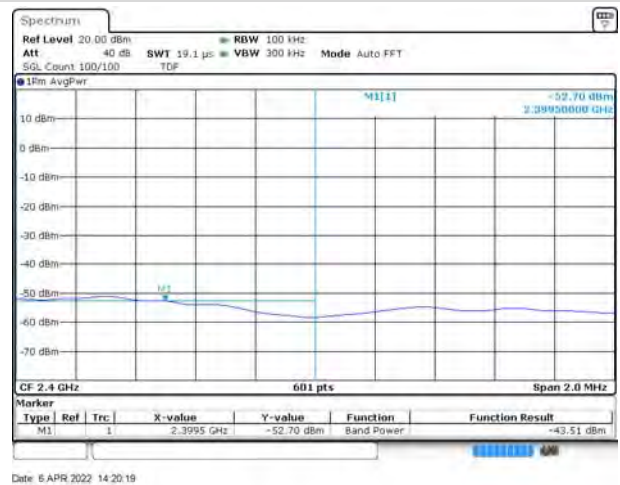

802.11b HIGH CHANNEL, CARRIER LEVEL



802.11b HIGH CHANNEL, REFERENCE LEVEL

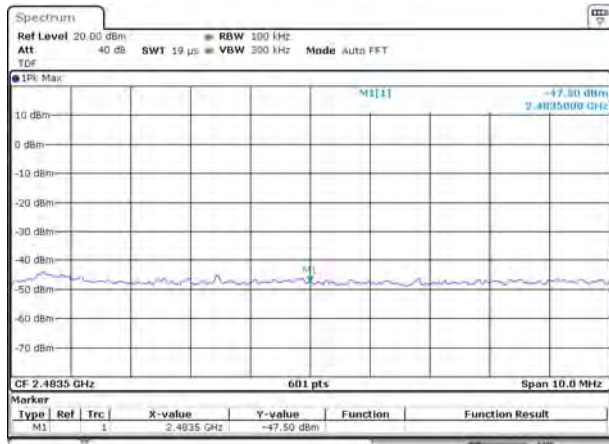

Date: 6 APR 2022 14:38:30

802.11b HIGH CHANNEL, BAND EDGE

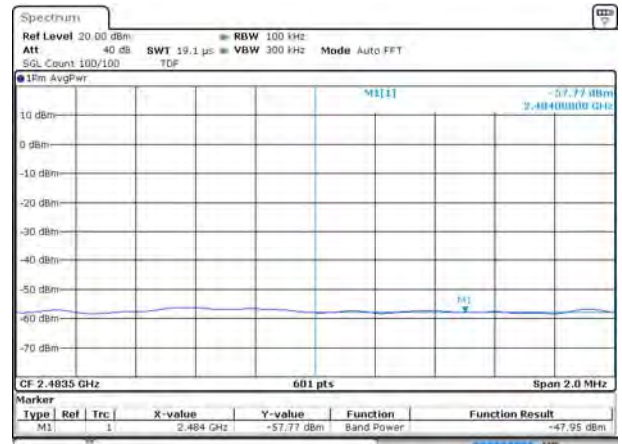

Date: 6 APR 2022 14:38:39

802.11g LOW CHANNEL, CARRIER LEVEL

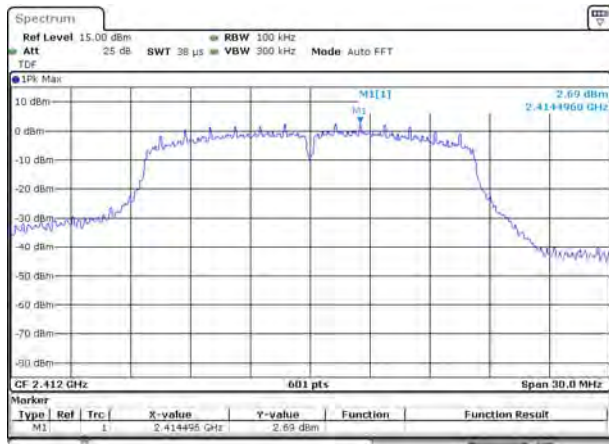

Date: 6 APR 2022 14:41:22

802.11g LOW CHANNEL, REFERENCE LEVEL

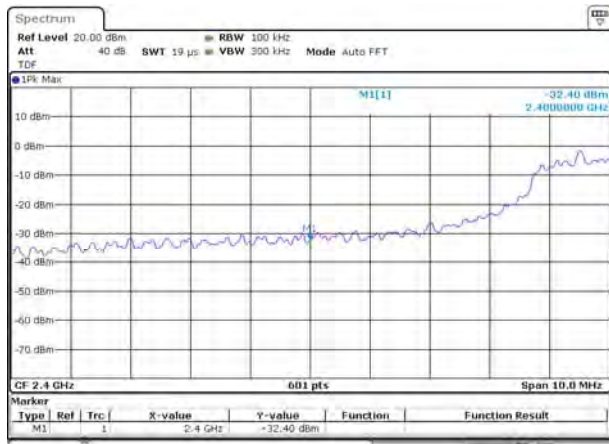

Date: 6 APR 2022 14:42:59

802.11g LOW CHANNEL, BAND EDGE

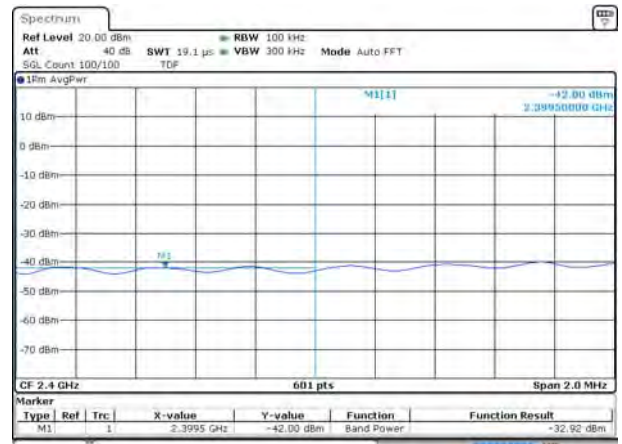

Date: 6 APR 2022 14:43:09

802.11g HIGH CHANNEL, CARRIER LEVEL

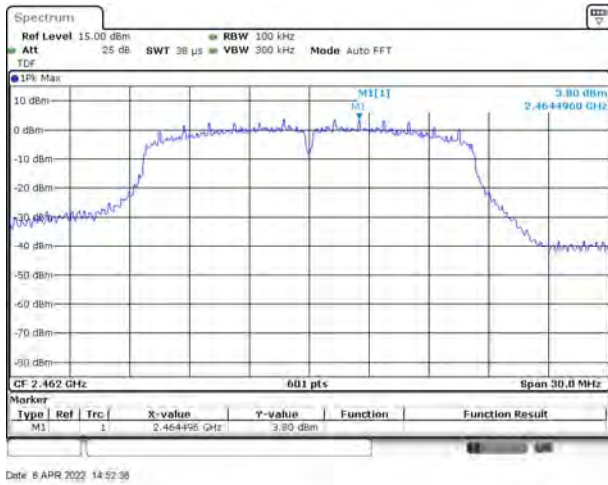

Date: 6 APR 2022 14:52:38

802.11g HIGH CHANNEL, REFERENCE LEVEL

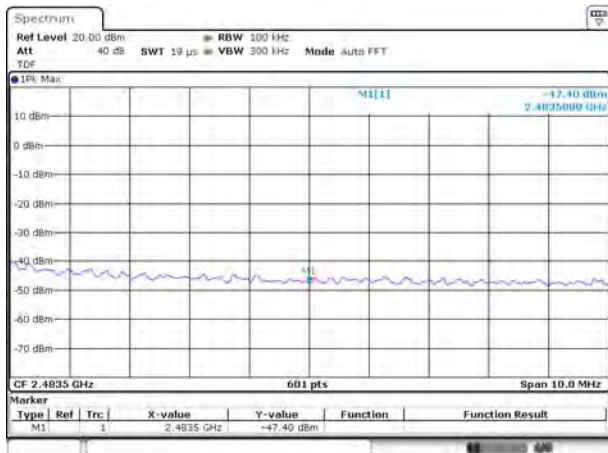

Date: 6 APR 2022 14:53:44

802.11g HIGH CHANNEL, BAND EDGE

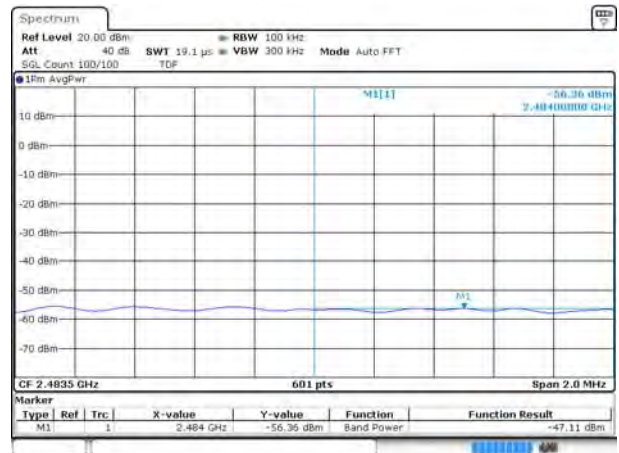

Date: 6 APR 2022 14:53:52

802.11n-20 MHz LOW CHANNEL, CARRIER LEVEL

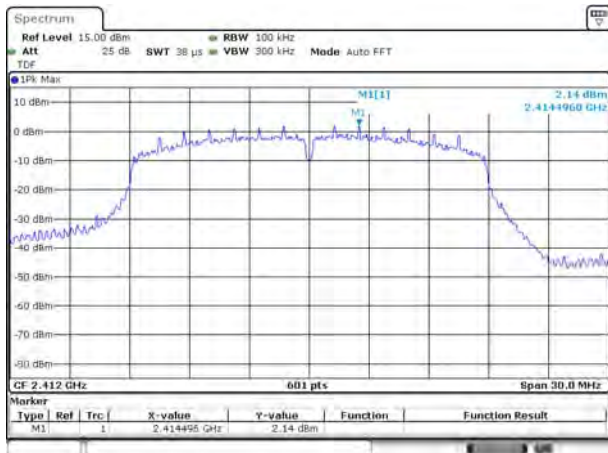

Date: 6 APR 2022 14:59:59

802.11n-20 MHz LOW CHANNEL, REFERENCE LEVEL

802.11n-20 MHz LOW CHANNEL, BAND EDGE

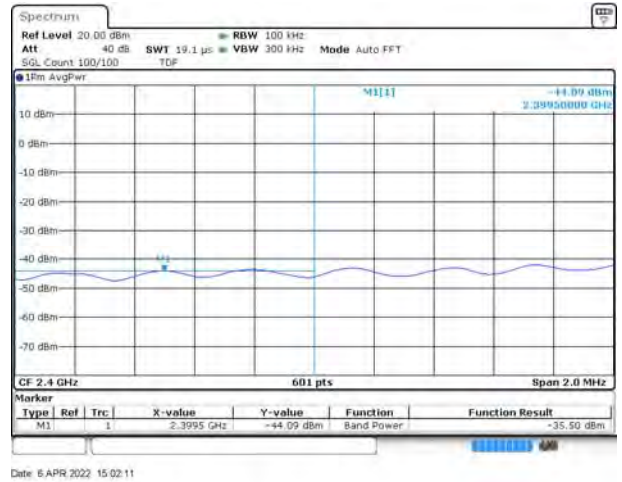
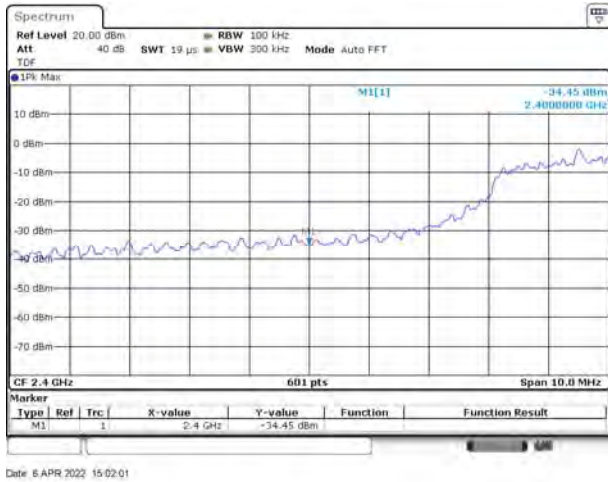

802.11n-20 MHz HIGH CHANNEL, CARRIER LEVEL

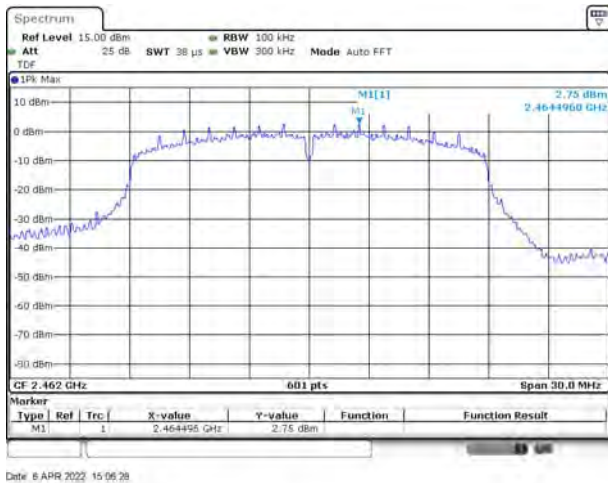

802.11n-20 MHz HIGH CHANNEL, REFERENCE LEVEL

802.11n-20 MHz HIGH CHANNEL, BAND EDGE

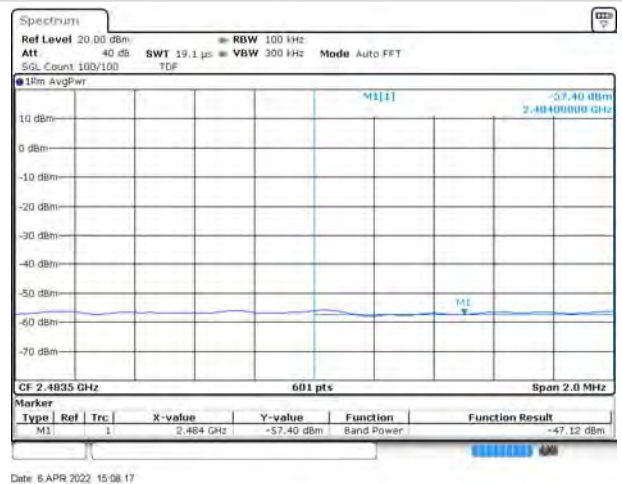
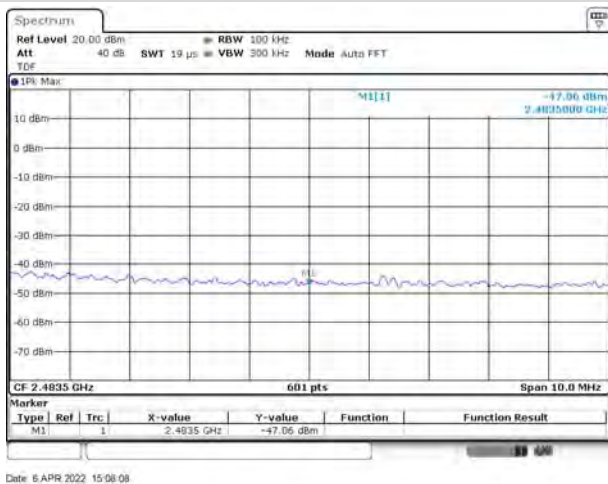

802.11n-40 MHz LOW CHANNEL, CARRIER LEVEL

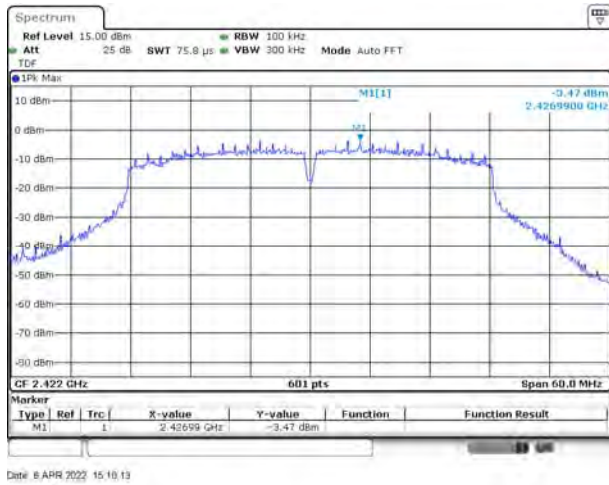

Date: 6 APR 2022 15:10:13

802.11n-40 MHz LOW CHANNEL, REFERENCE LEVEL

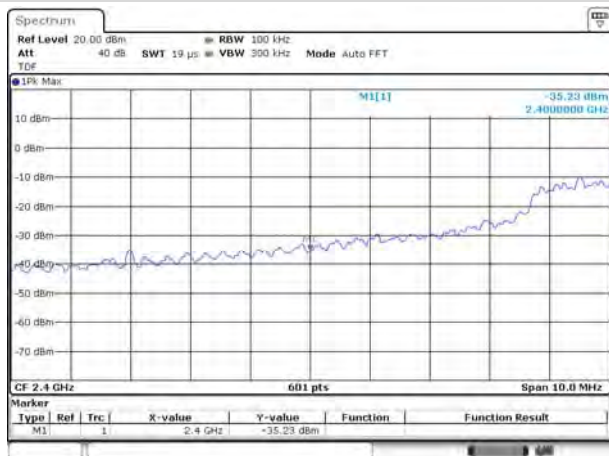

Date: 6 APR 2022 15:12:45

802.11n-40 MHz LOW CHANNEL, BAND EDGE

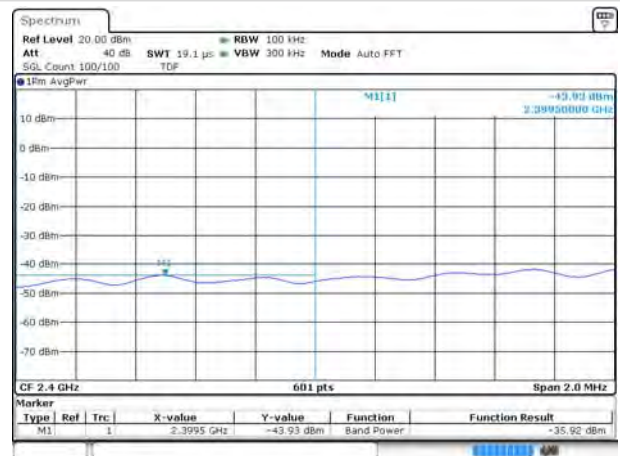

Date: 6 APR 2022 15:13:07

802.11n-40 MHz HIGH CHANNEL, CARRIER LEVEL

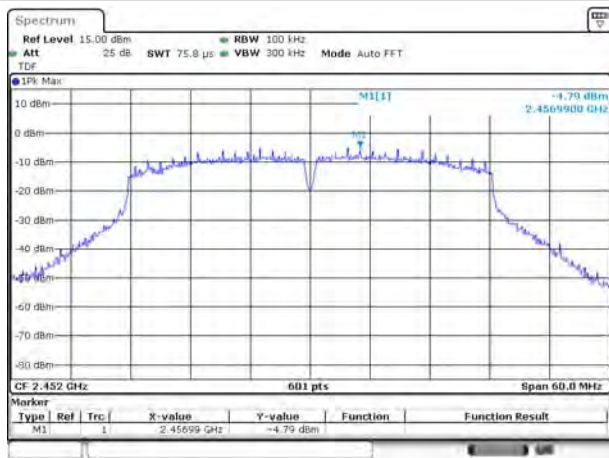

Date: 6 APR 2022 15:21:32

802.11n-40 MHz HIGH CHANNEL,
REFERENCE LEVEL

802.11n-40 MHz HIGH CHANNEL, BAND EDGE

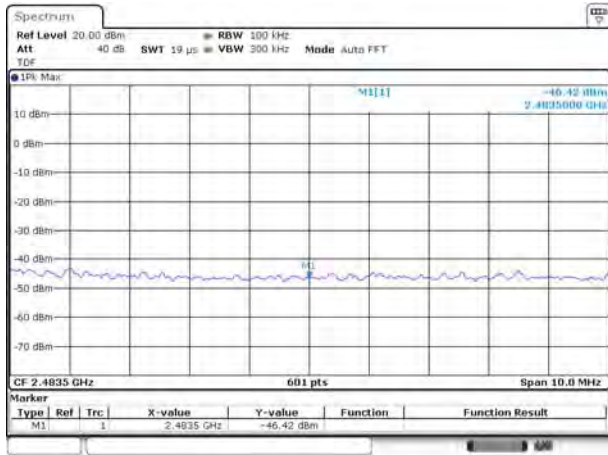

Date: 6 APR 2022 15:22:58

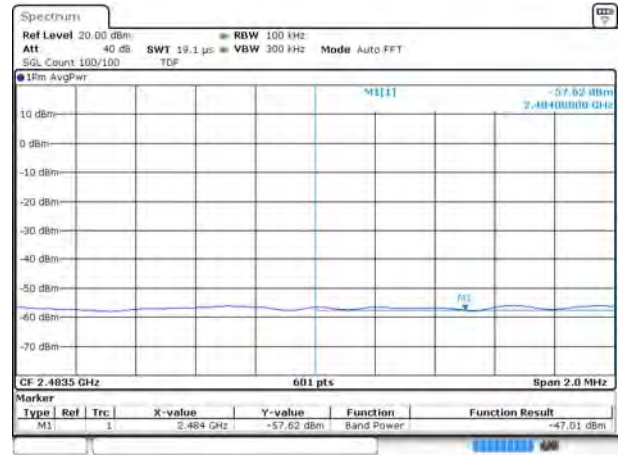

Date: 6 APR 2022 15:23:06

Aux. Antenna

802.11b LOW CHANNEL, CARRIER LEVEL

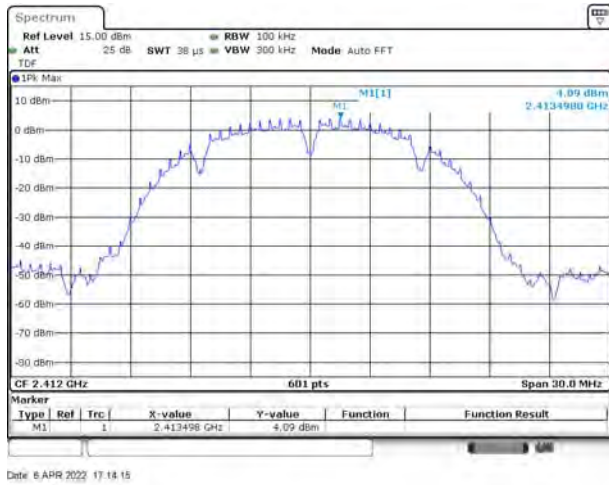

Date: 6 APR 2022 17:18:15

802.11b LOW CHANNEL, REFERENCE LEVEL

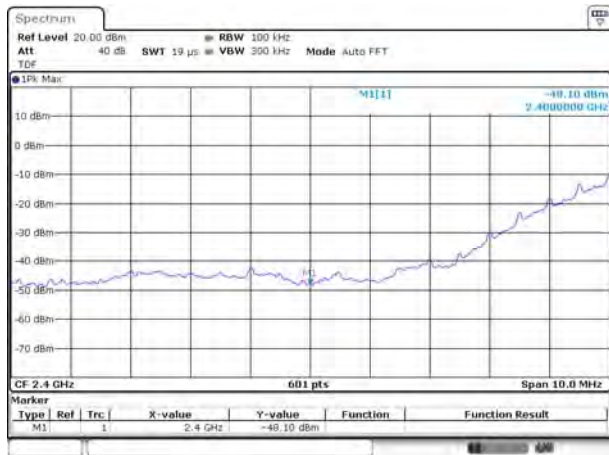

Date: 6 APR 2022 17:15:50

802.11b LOW CHANNEL, BAND EDGE

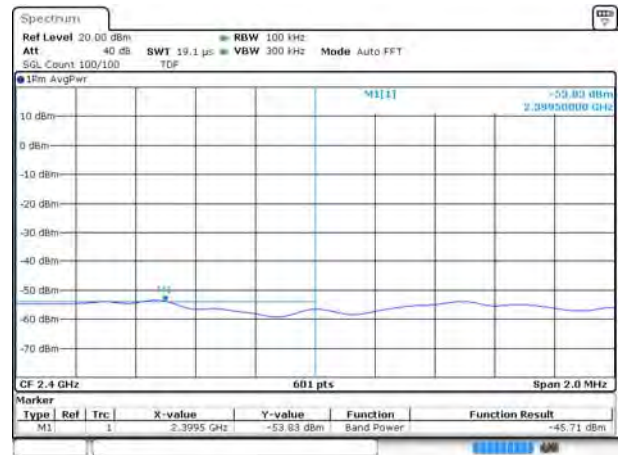

Date: 6 APR 2022 17:16:00

802.11b HIGH CHANNEL, CARRIER LEVEL

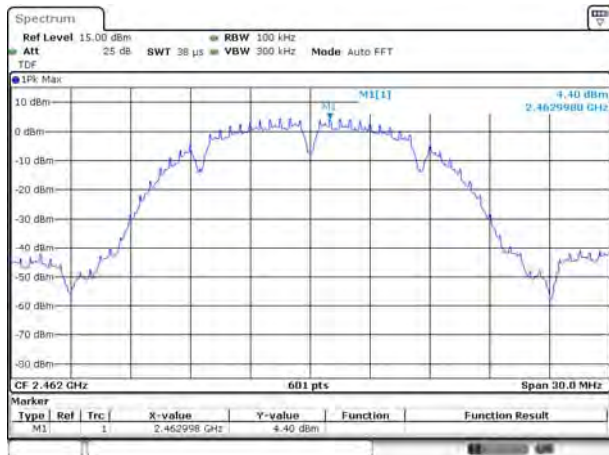

Date: 6 APR 2022 17:20:25

802.11b HIGH CHANNEL, REFERENCE LEVEL

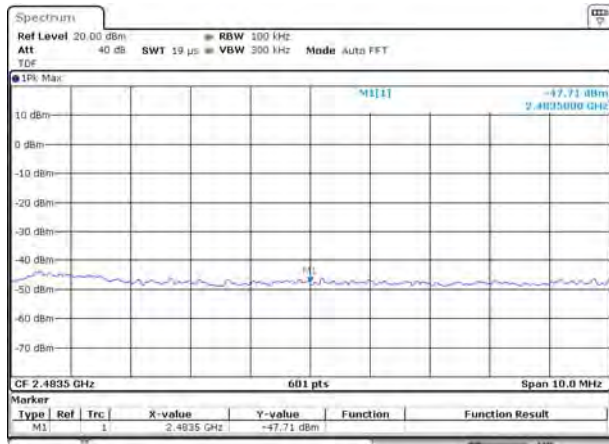

Date: 6 APR 2022 17:21:30

802.11b HIGH CHANNEL, BAND EDGE

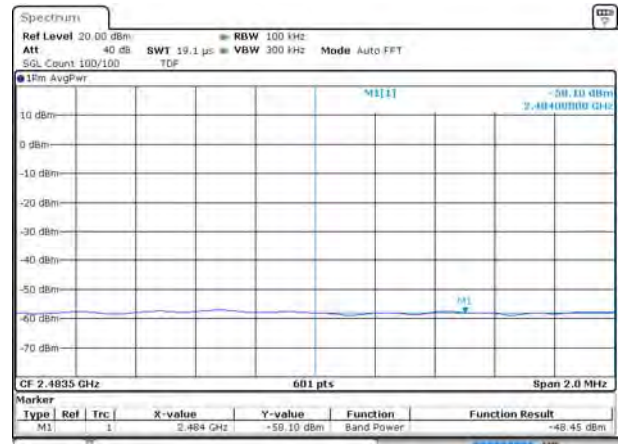

Date: 6 APR 2022 17:26:02

802.11g LOW CHANNEL, CARRIER LEVEL

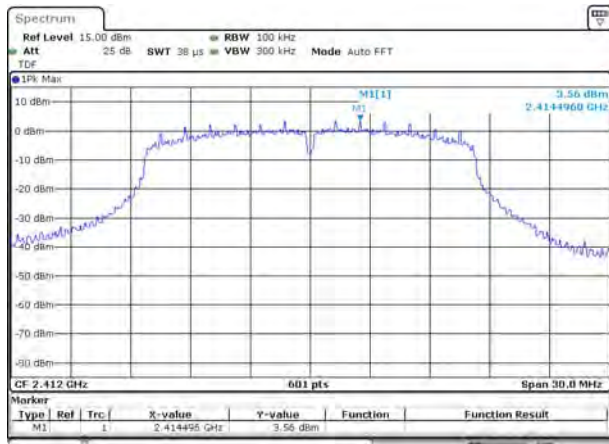

Date: 6 APR 2022 17:28:37

802.11g LOW CHANNEL, REFERENCE LEVEL

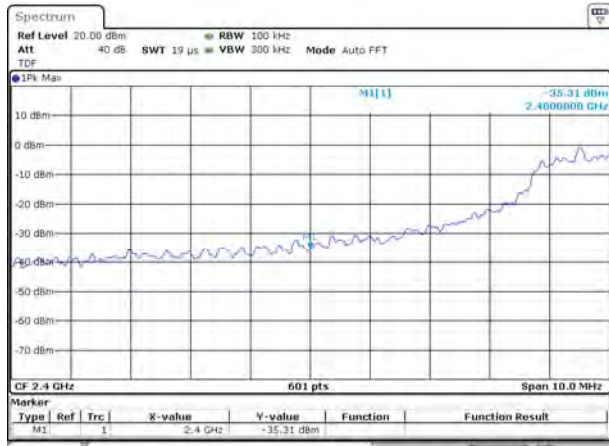

Date: 6 APR 2022 17:29:59

802.11g LOW CHANNEL, BAND EDGE

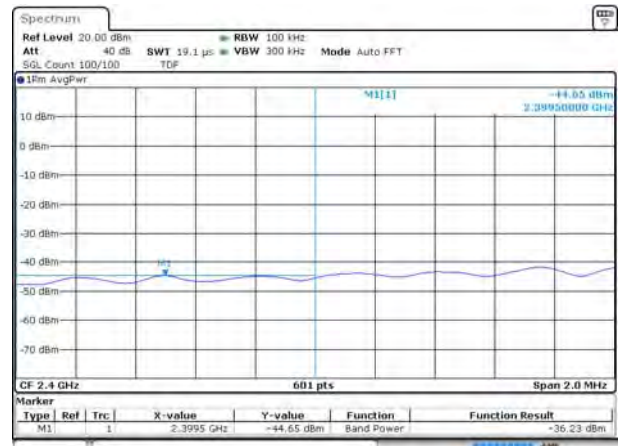

Date: 6 APR 2022 17:30:05

802.11g HIGH CHANNEL, CARRIER LEVEL

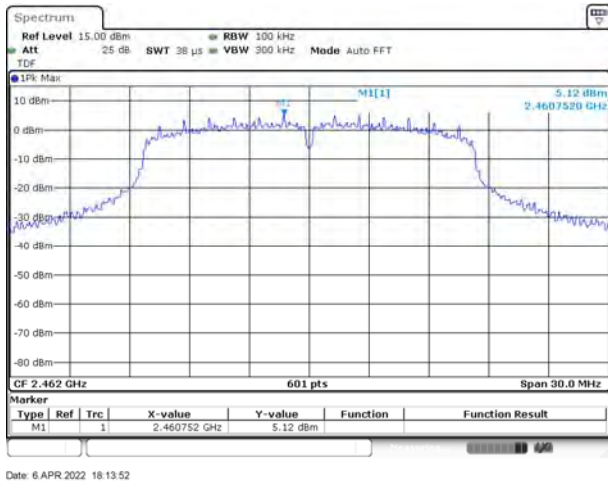

Date: 6 APR 2022 18:13:52

802.11g HIGH CHANNEL, REFERENCE LEVEL

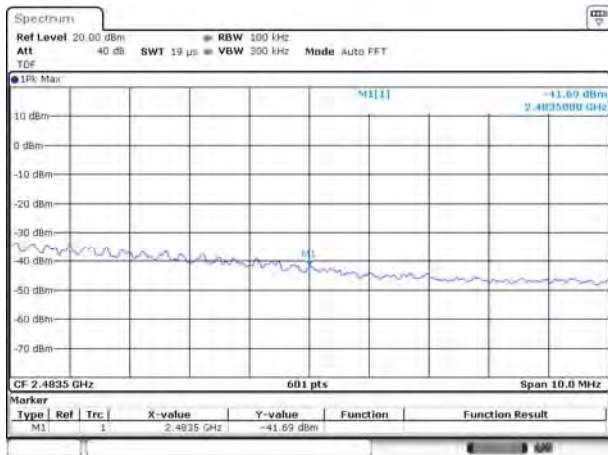

Date: 6 APR 2022 18:15:14

802.11g HIGH CHANNEL, BAND EDGE

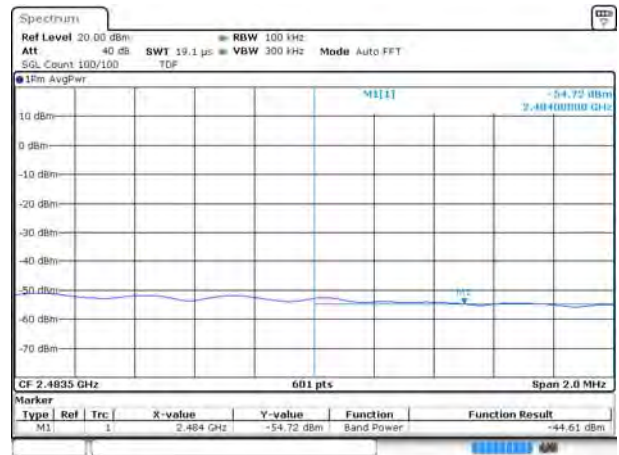

Date: 6 APR 2022 18:15:21

802.11n-20 MHz LOW CHANNEL, CARRIER LEVEL

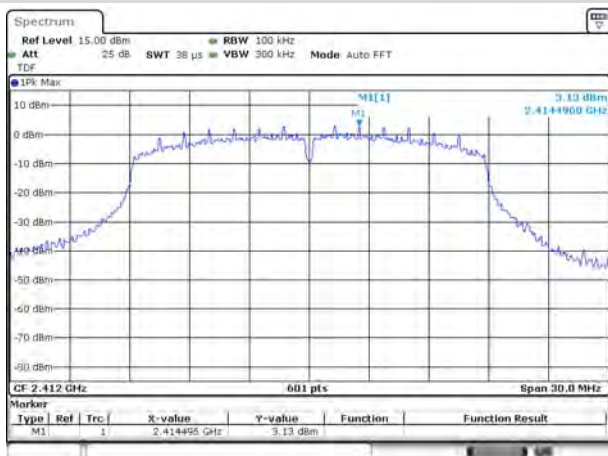

Date: 6 APR 2022 18:16:58

802.11n-20 MHz LOW CHANNEL, REFERENCE LEVEL

802.11n-20 MHz LOW CHANNEL, BAND EDGE

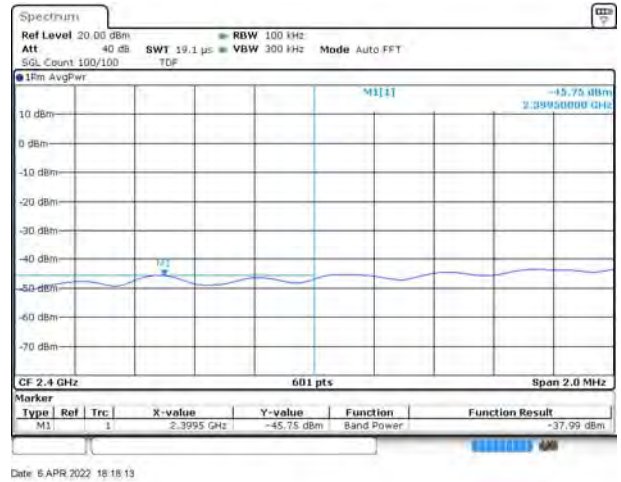
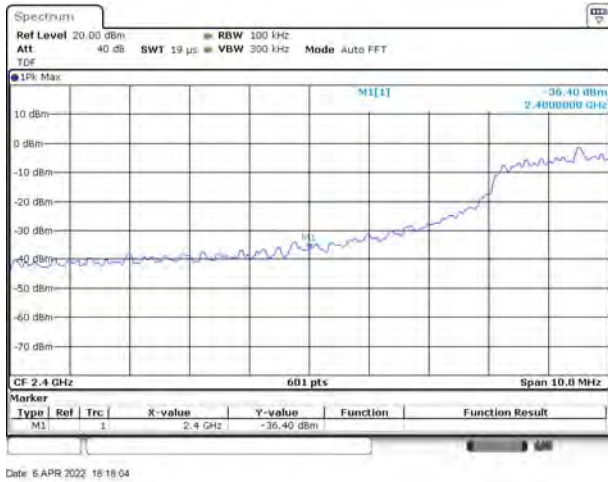

802.11n-20 MHz HIGH CHANNEL, CARRIER LEVEL

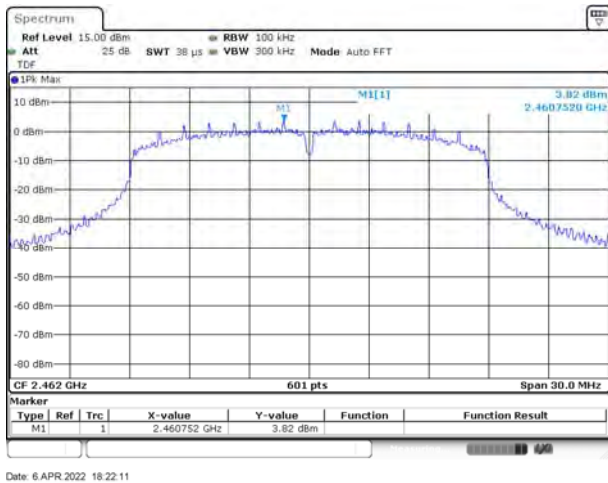

802.11n-20 MHz HIGH CHANNEL, REFERENCE LEVEL

802.11n-20 MHz HIGH CHANNEL, BAND EDGE

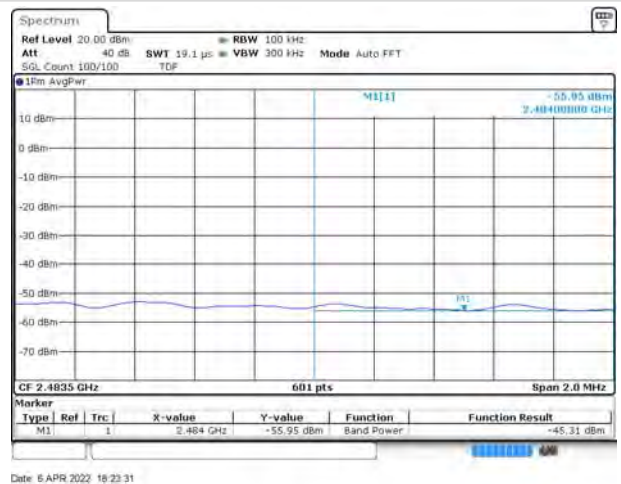
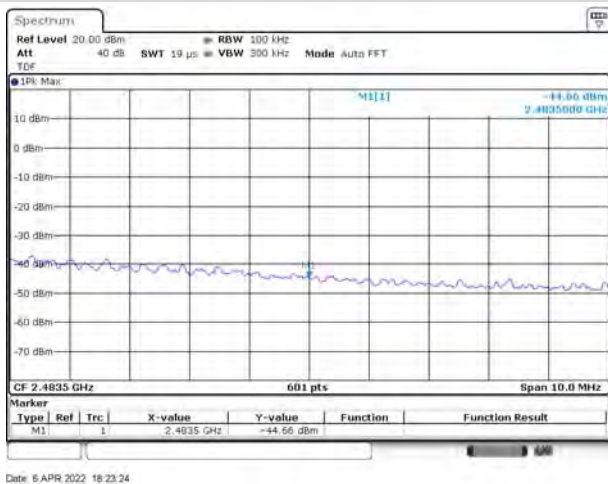

802.11n-40 MHz LOW CHANNEL, CARRIER LEVEL

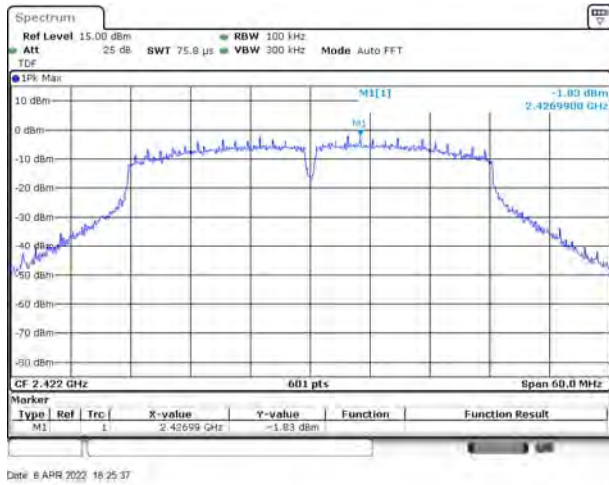

802.11n-40 MHz LOW CHANNEL, REFERENCE LEVEL



802.11n-40 MHz LOW CHANNEL, BAND EDGE

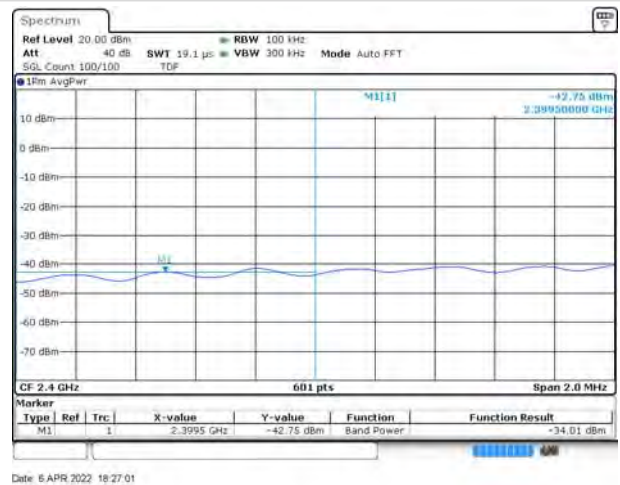

802.11n-40 MHz HIGH CHANNEL, CARRIER LEVEL

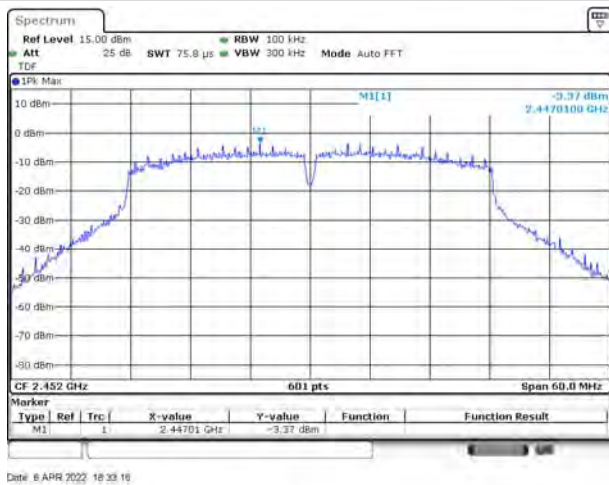

802.11n-40 MHz HIGH CHANNEL,
REFERENCE LEVEL

802.11n-40 MHz HIGH CHANNEL, BAND EDGE

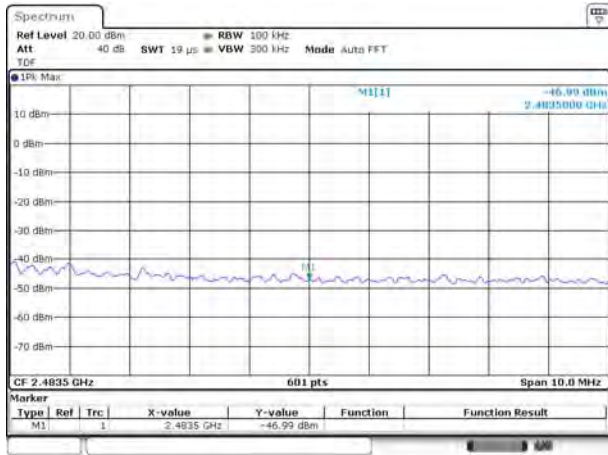

Date: 6 APR 2022 18:34:17

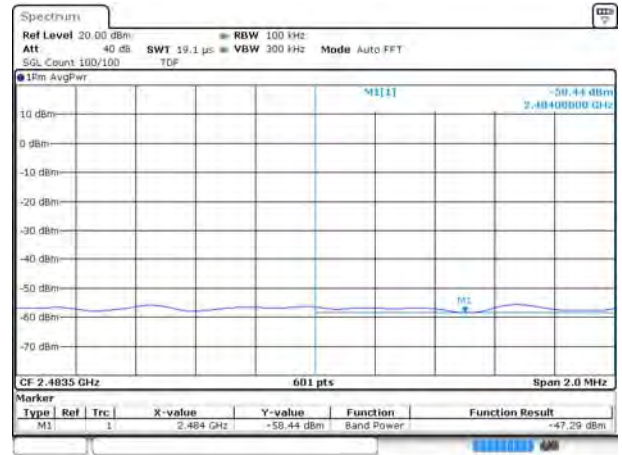

Date: 6 APR 2022 18:34:25

MIMO-Main Antenna

802.11n-20 MHz LOW CHANNEL, CARRIER LEVEL

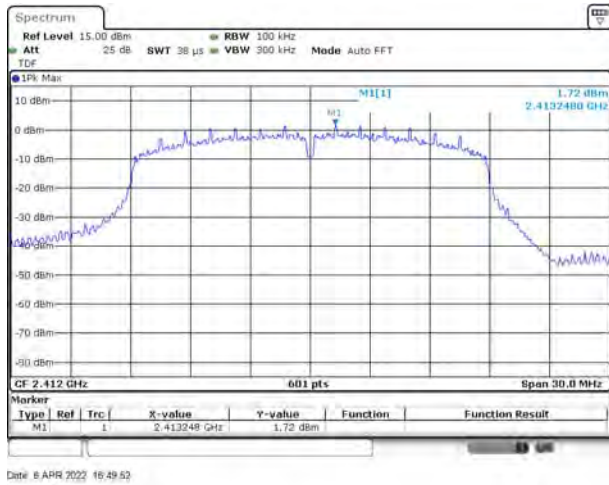

Date: 6 APR 2022 16:49:53

802.11n-20 MHz LOW CHANNEL, REFERENCE LEVEL

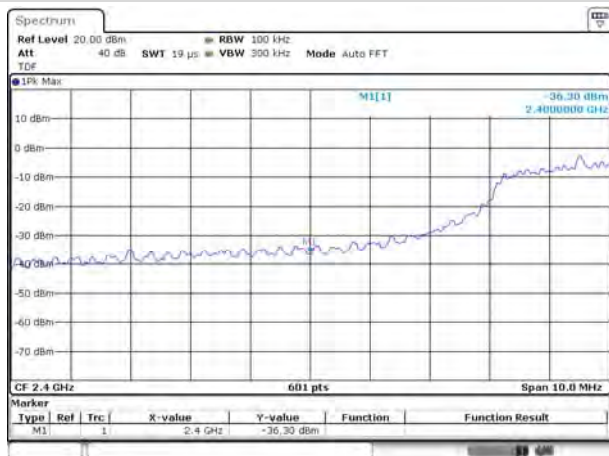

Date: 6 APR 2022 16:52:17

802.11n-20 MHz LOW CHANNEL, BAND EDGE

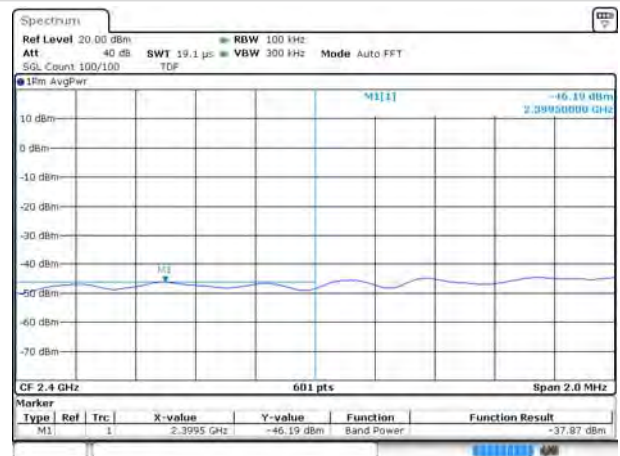

Date: 6 APR 2022 16:53:04

802.11n-20 MHz HIGH CHANNEL, CARRIER LEVEL

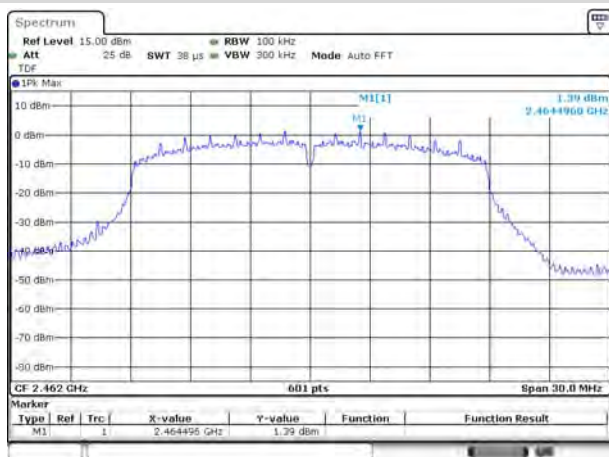

Date: 6 APR 2022 16:58:26

802.11n-20 MHz HIGH CHANNEL, REFERENCE LEVEL

802.11n-20 MHz HIGH CHANNEL, BAND EDGE

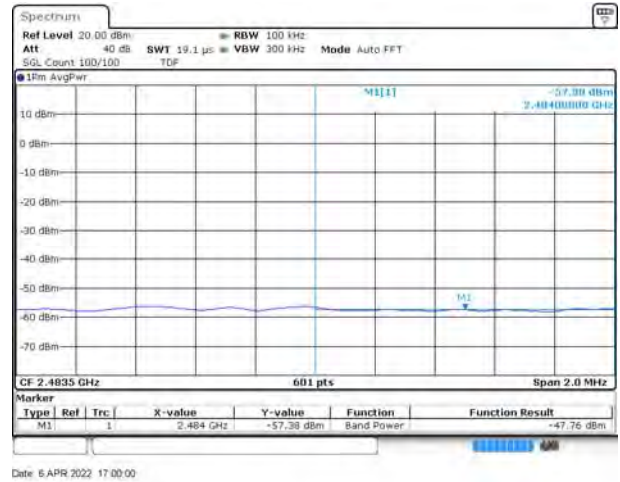
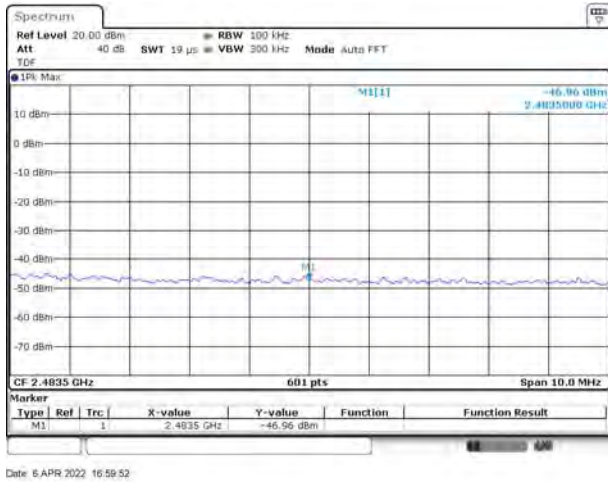

802.11n-40 MHz LOW CHANNEL, CARRIER LEVEL

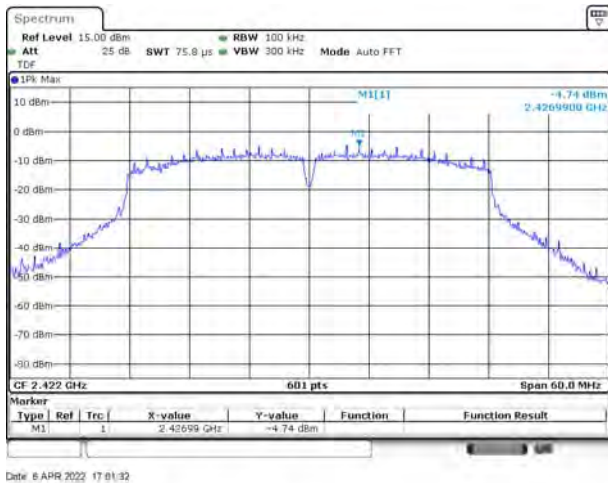

802.11n-40 MHz LOW CHANNEL, REFERENCE LEVEL

802.11n-40 MHz LOW CHANNEL, BAND EDGE

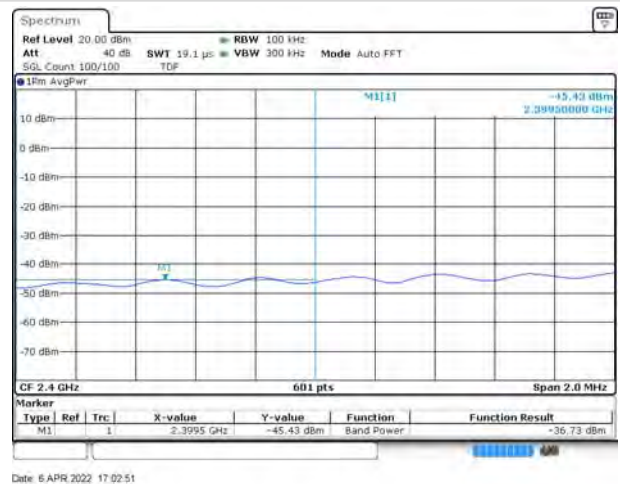

802.11n-40 MHz HIGH CHANNEL, CARRIER LEVEL

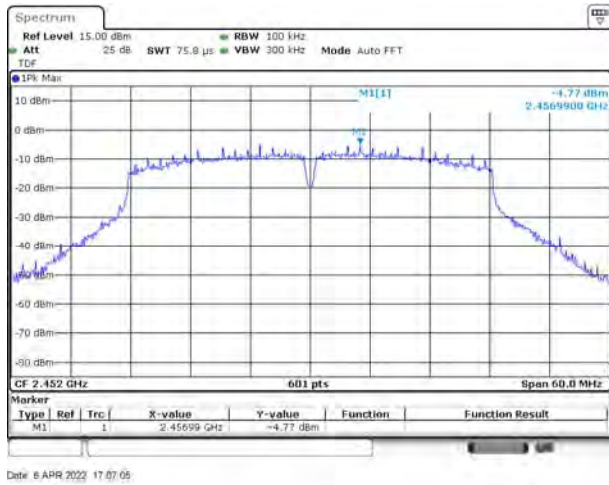

802.11n-40 MHz HIGH CHANNEL, REFERENCE LEVEL

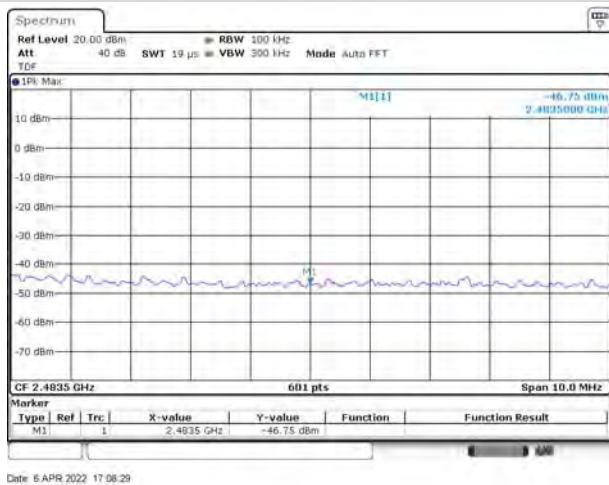

802.11n-40 MHz HIGH CHANNEL, BAND EDGE

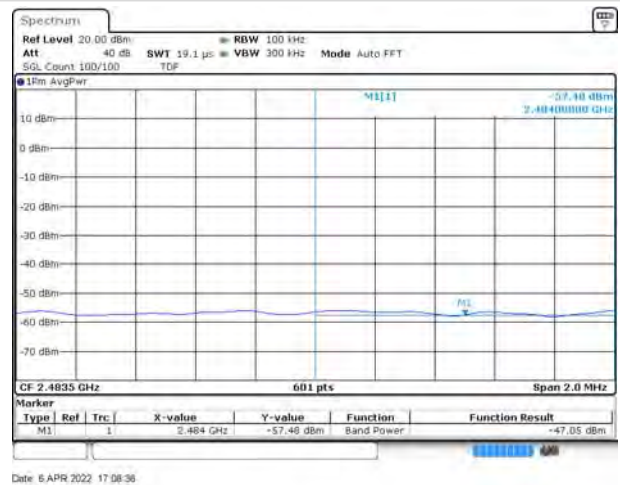

MIMO-Aux. Antenna

802.11n-20 MHz LOW CHANNEL, CARRIER LEVEL

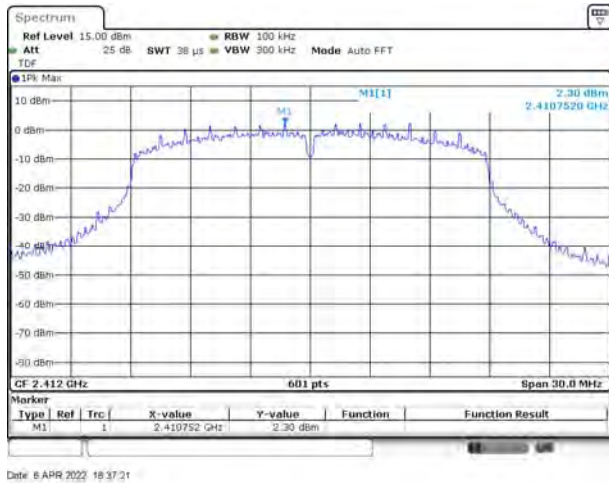

Date: 6 APR 2022 16:37:21

802.11n-20 MHz LOW CHANNEL, REFERENCE LEVEL

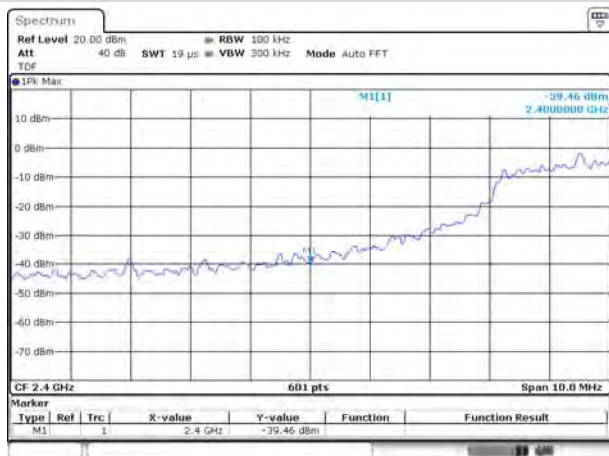

Date: 6 APR 2022 16:39:05

802.11n-20 MHz LOW CHANNEL, BAND EDGE

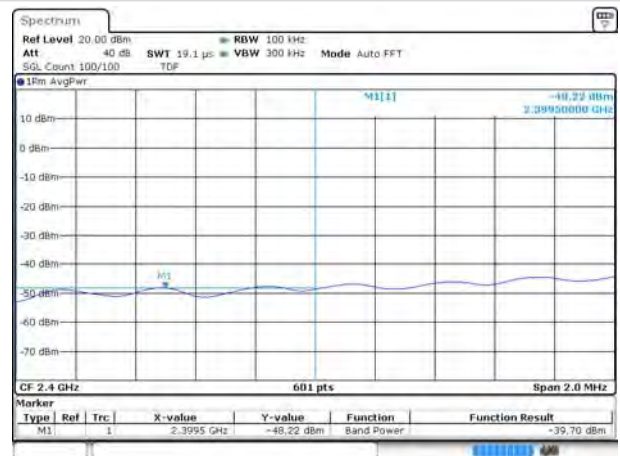

Date: 6 APR 2022 16:39:14

802.11n-20 MHz HIGH CHANNEL, CARRIER LEVEL

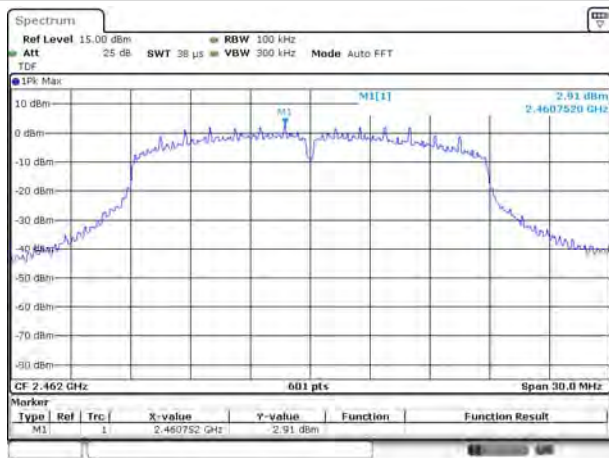

Date: 6 APR 2022 16:43:16

802.11n-20 MHz HIGH CHANNEL, REFERENCE LEVEL

802.11n-20 MHz HIGH CHANNEL, BAND EDGE

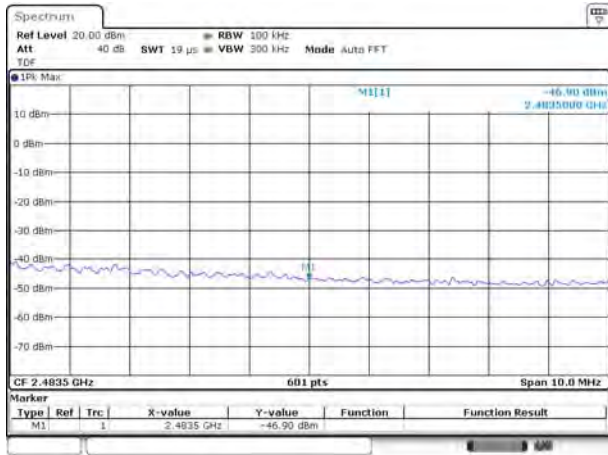

Date: 6 APR 2022 18:44:51

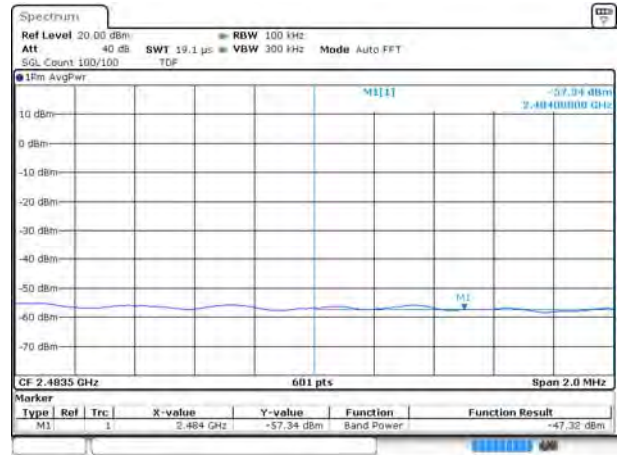

Date: 6 APR 2022 18:44:57

802.11n-40 MHz LOW CHANNEL, CARRIER LEVEL

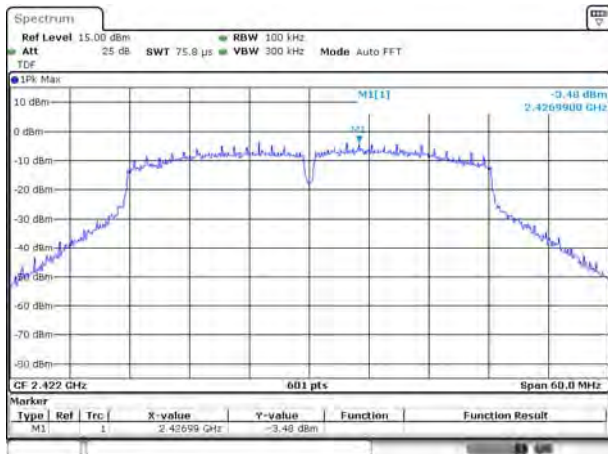

Date: 6 APR 2022 18:46:34

802.11n-40 MHz LOW CHANNEL, REFERENCE LEVEL

802.11n-40 MHz LOW CHANNEL, BAND EDGE

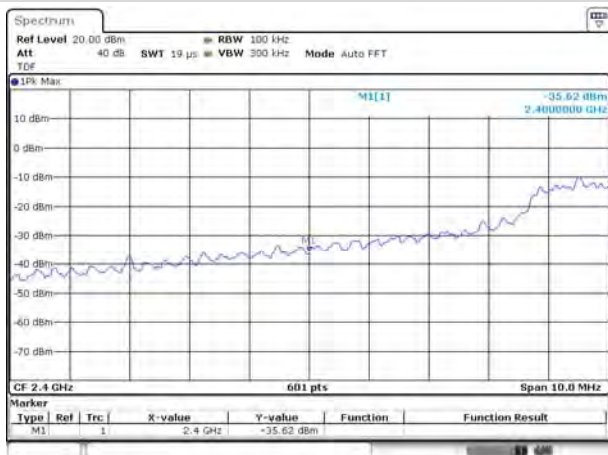

Date: 6 APR 2022 18:47:35

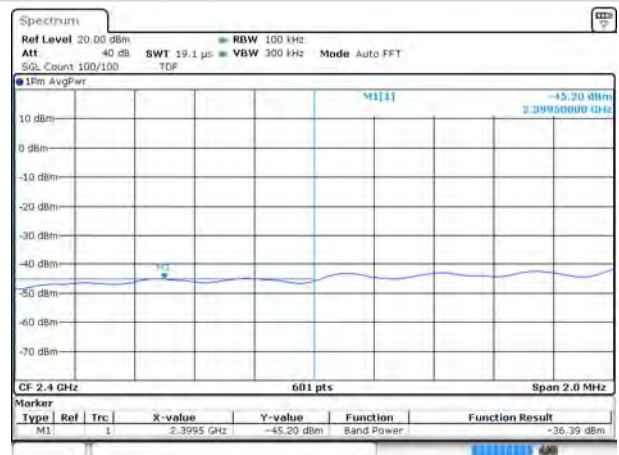

Date: 6 APR 2022 18:47:50

802.11n-40 MHz HIGH CHANNEL, CARRIER LEVEL

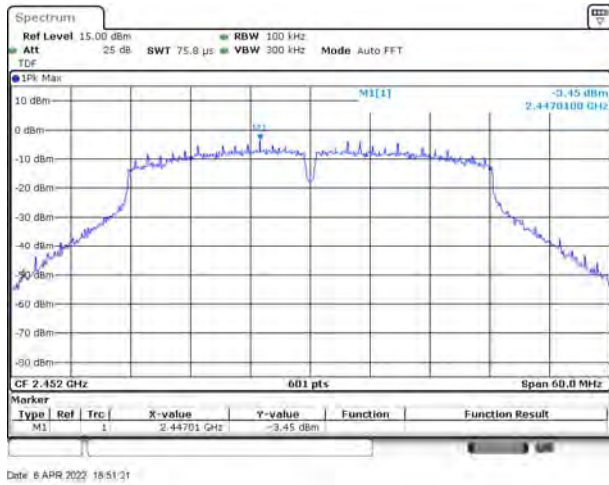

802.11n-40 MHz HIGH CHANNEL, REFERENCE LEVEL

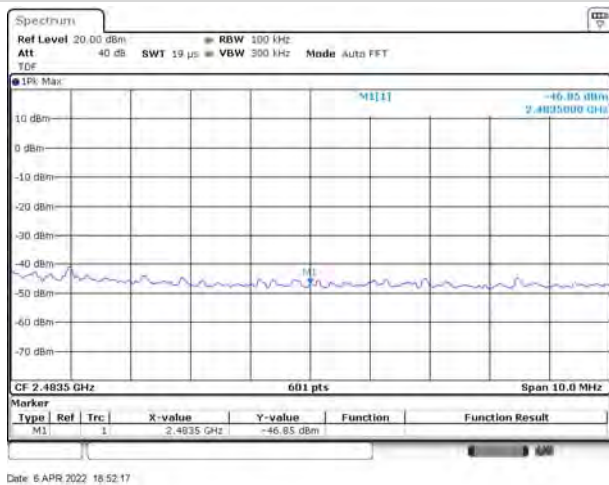

802.11n-40 MHz HIGH CHANNEL, BAND EDGE

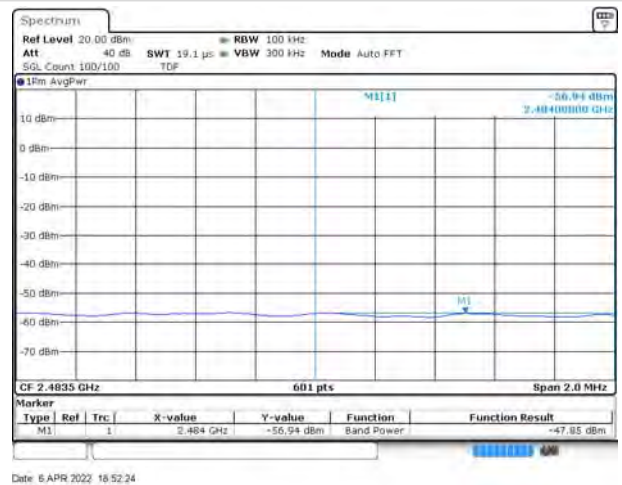

A.5 Conducted Emissions

Note ¹: The EUT is working in the Normal link mode. All modes have been tested and normal link mode is worst.

Note ²: Devices subject to Part 15 must be tested for all available U.S. voltages and frequencies (such as a nominal 120 VAC, 60 Hz and 240 VAC, 50 Hz) for which the device is capable of operation. So, The configuration 120 VAC, 60 Hz and 240 VAC, 50 Hz were tested respectively, but only the worst configuration (120 VAC, 60 Hz) shown here.

Test Data and Plots

PHASE L

CE Test case_FCC_CE_FCC PART 15B_ Class B

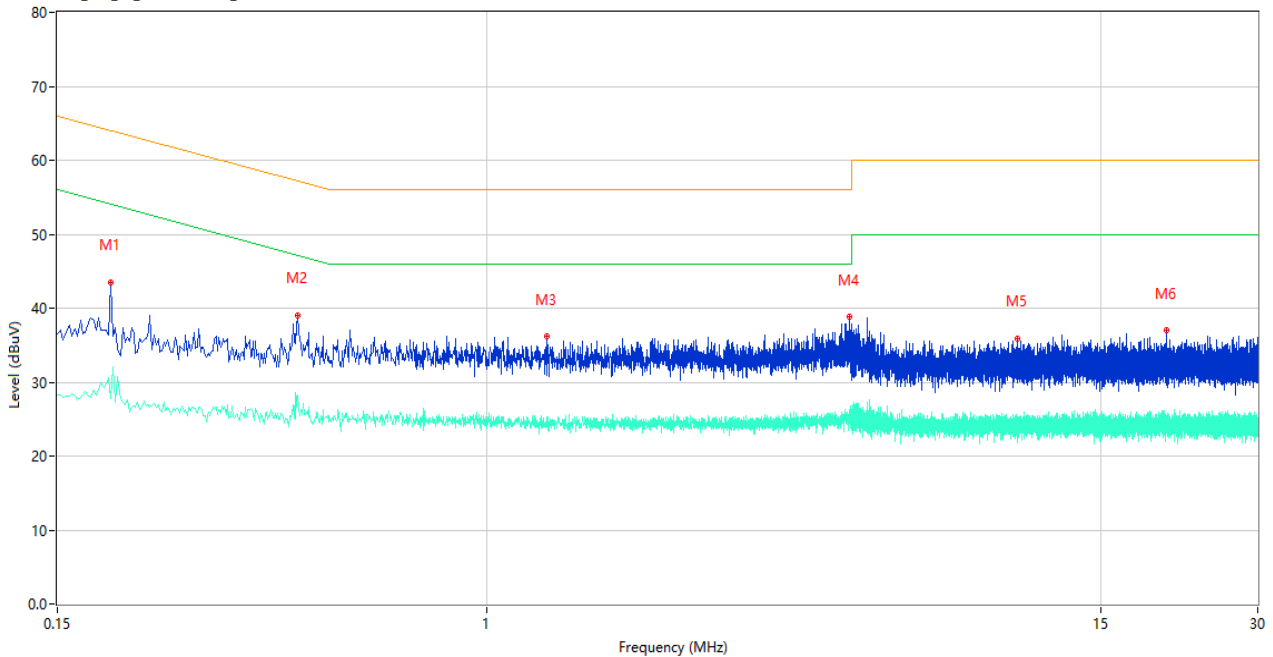

No.	Frequency (MHz)	Results (dBUV)	Factor (dB)	Limit (dBUV)	Over Limit (dB)	Detector	Line	Verdict
1	0.190	43.51	10.96	64.04	-20.53	Peak	L	Pass
1**	0.190	27.81	10.96	54.04	-26.23	AV	L	Pass
2	0.434	39.08	10.91	57.18	-18.10	Peak	L	Pass
2**	0.434	28.24	10.91	47.18	-18.94	AV	L	Pass
3	1.302	36.23	10.72	56.00	-19.77	Peak	L	Pass
3**	1.302	25.26	10.72	46.00	-20.74	AV	L	Pass
4	4.940	38.80	10.68	56.00	-17.20	Peak	L	Pass
4**	4.940	26.27	10.68	46.00	-19.73	AV	L	Pass
5	10.410	35.91	10.67	60.00	-24.09	Peak	L	Pass
5**	10.410	25.15	10.67	50.00	-24.85	AV	L	Pass
6	20.098	37.07	10.71	60.00	-22.93	Peak	L	Pass
6**	20.098	24.05	10.71	50.00	-25.95	AV	L	Pass

PHASE N

CE Test case_FCC_CE_FCC PART 15B_Class B

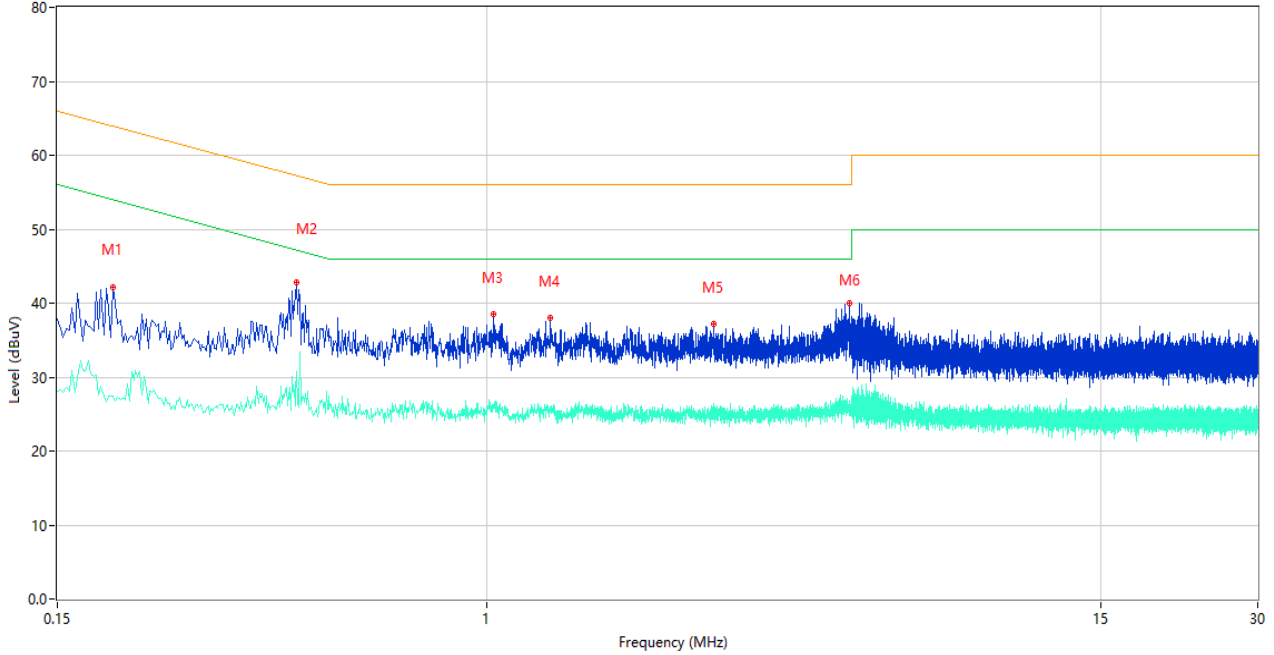

No.	Frequency (MHz)	Results (dBUV)	Factor (dB)	Limit (dBUV)	Over Limit (dB)	Detector	Line	Verdict
1	0.192	42.20	10.96	63.95	-21.75	Peak	N	Pass
1**	0.192	27.46	10.96	53.95	-26.49	AV	N	Pass
2	0.432	42.79	10.91	57.21	-14.42	Peak	N	Pass
2**	0.432	30.71	10.91	47.21	-16.50	AV	N	Pass
3	1.028	38.50	10.70	56.00	-17.50	Peak	N	Pass
3**	1.028	26.15	10.70	46.00	-19.85	AV	N	Pass
4	1.320	37.94	10.72	56.00	-18.06	Peak	N	Pass
4**	1.320	25.92	10.72	46.00	-20.08	AV	N	Pass
5	2.724	37.19	10.71	56.00	-18.81	Peak	N	Pass
5**	2.724	26.46	10.71	46.00	-19.54	AV	N	Pass
6	4.950	40.08	10.68	56.00	-15.92	Peak	N	Pass
6**	4.950	26.83	10.68	46.00	-19.17	AV	N	Pass

A.6 Radiated Emission

Note ¹: The symbol of "--" in the table which means not application.

Note ²: For the test data above 1 GHz, According the ANSI C63.10-2013, where limits are specified for both average and peak (or quasi-peak) detector functions, if the peak (or quasi-peak) measured value complies with the average limit, it is unnecessary to perform an average measurement.

Note ³: The low frequency, which started from 9 kHz to 30 MHz, was pre-scanned and the result which was 20 dB lower than the limit line per 15.31(o) was not reported.

Note ⁴: The EUT is working in the Normal link mode below 1 GHz. All modes have been tested and normal link mode is worst.

Test Data and Plots

30 MHz to 1 GHz, ANT H

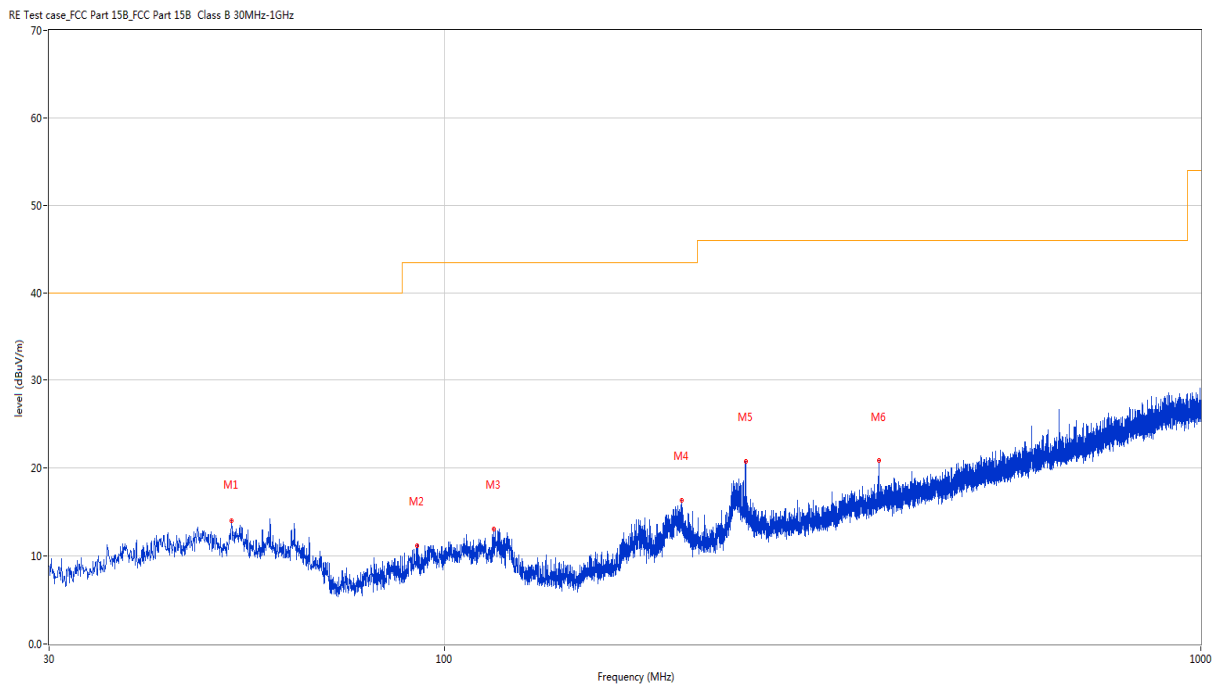

No.	Frequency (MHz)	Results (dBuV/m)	Factor (dB)	Limit (dBuV/m)	Over Limit (dB)	Detector	Table (Degree)	Height (cm)	Antenna	Verdict
1	52.310	14.04	-23.12	40.0	-25.96	Peak	0.30	200	Horizontal	Pass
2	91.886	11.17	-25.66	43.5	-32.33	Peak	204.50	100	Horizontal	Pass
3	116.088	13.06	-25.63	43.5	-30.44	Peak	158.30	100	Horizontal	Pass
4	205.812	16.26	-23.82	43.5	-27.24	Peak	253.90	100	Horizontal	Pass
5	250.044	20.74	-22.91	46.0	-25.26	Peak	166.90	100	Horizontal	Pass
6	375.029	20.85	-19.08	46.0	-25.15	Peak	0.00	200	Horizontal	Pass

30 MHz to 1 GHz, ANT V

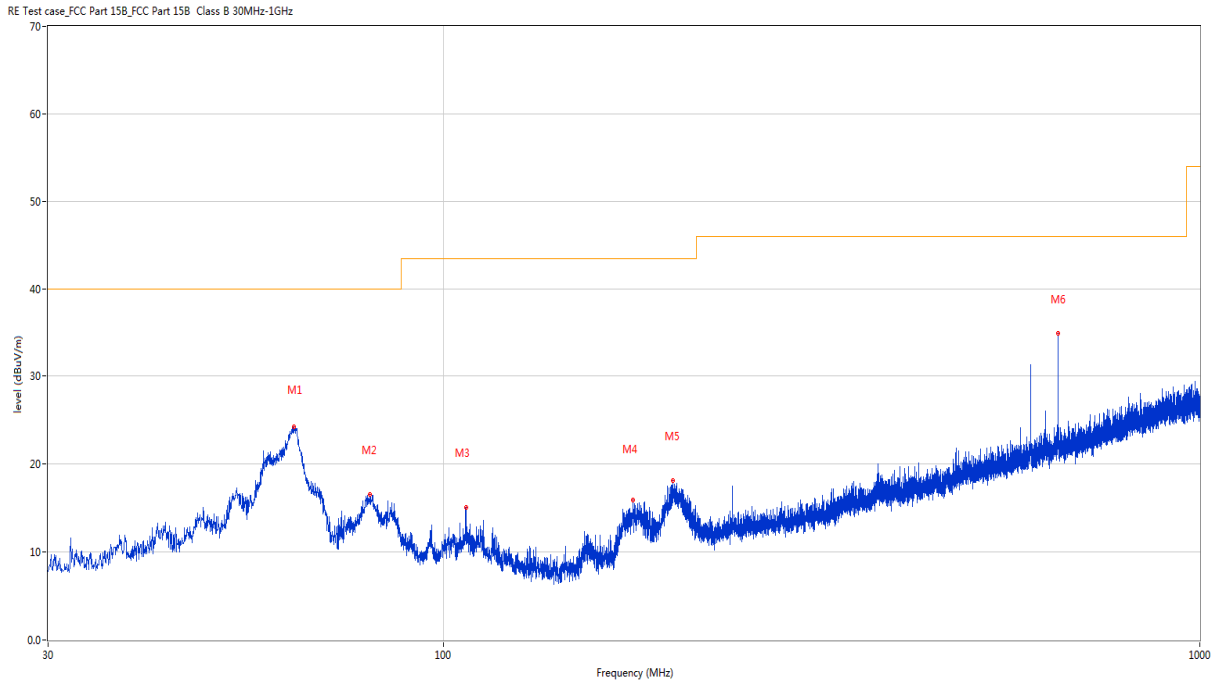

No.	Frequency (MHz)	Results (dBuV/m)	Factor (dB)	Limit (dBuV/m)	Over Limit (dB)	Detector	Table (Degree)	Height (cm)	Antenna	Verdict
1	63.416	24.19	-24.83	40.0	-15.81	Peak	325.70	100	Vertical	Pass
2	80.004	16.48	-28.47	40.0	-23.52	Peak	312.40	100	Vertical	Pass
3	107.018	15.03	-24.18	43.5	-28.47	Peak	252.60	100	Vertical	Pass
4	178.119	15.85	-26.17	43.5	-27.65	Peak	299.50	100	Vertical	Pass
5	201.108	18.13	-23.93	43.5	-25.37	Peak	201.90	100	Vertical	Pass
6	650.024	34.92	-13.51	46.0	-11.08	Peak	360.00	200	Vertical	Pass

Note 1: The marked spikes near 2400 MHz with circle should be ignored because they are Fundamental signal.

Note 2: The spurious above 18G is noise only, do not show on the report.

Note 3: All antenna were tested, but only the worst case has been reported in this report.

Main Antenna

1 GHz to 18 GHz, ANT H 802.11b Low Channel

No.	Frequency (MHz)	Results (dBuV/m)	Factor (dB)	Limit (dBuV/m)	Over Limit (dB)	Detector	Table (Degree)	Height (cm)	Antenna	Verdict
1	1329.900	39.84	-17.42	74.0	-34.16	Peak	352.00	150	Horizontal	Pass
1**	1329.900	29.53	-17.42	54.0	-24.47	AV	352.00	150	Horizontal	Pass
2	2413.400	103.57	-12.26	74.0	29.57	Peak	187.00	150	Horizontal	N/A
2**	2413.400	100.40	-12.26	54.0	46.40	AV	187.00	150	Horizontal	N/A
3	4824.000	52.94	-3.38	74.0	-21.06	Peak	130.00	150	Horizontal	Pass
3**	4824.000	50.81	-3.38	54.0	-3.19	AV	130.00	150	Horizontal	Pass
4	6687.600	54.32	-0.24	74.0	-19.68	Peak	90.00	150	Horizontal	Pass
4**	6687.600	44.84	-0.24	54.0	-9.16	AV	90.00	150	Horizontal	Pass
5	9691.000	51.03	0.12	74.0	-22.97	Peak	293.00	150	Horizontal	Pass
5**	9691.000	41.83	0.12	54.0	-12.17	AV	293.00	150	Horizontal	Pass
6	13407.300	55.79	0.53	74.0	-18.21	Peak	234.00	150	Horizontal	Pass
6**	13407.300	47.07	0.53	54.0	-6.93	AV	234.00	150	Horizontal	Pass

1 GHz to 18 GHz, ANT V 802.11b Low Channel

No.	Frequency (MHz)	Results (dBuV/m)	Factor (dB)	Limit (dBuV/m)	Over Limit (dB)	Detector	Table (Degree)	Height (cm)	Antenna	Verdict
1	1329.400	43.69	-17.44	74.0	-30.31	Peak	22.00	150	Vertical	Pass
1**	1329.400	35.80	-17.44	54.0	-18.20	AV	22.00	150	Vertical	Pass
2	2413.000	98.70	-12.26	74.0	24.70	Peak	154.00	150	Vertical	N/A
2**	2413.000	95.80	-12.26	54.0	41.80	AV	154.00	150	Vertical	N/A
3	4824.000	52.98	-3.38	74.0	-21.02	Peak	27.00	150	Vertical	Pass
3**	4824.000	49.96	-3.38	54.0	-4.04	AV	27.00	150	Vertical	Pass
4	6674.800	53.79	-0.65	74.0	-20.21	Peak	0.00	150	Vertical	Pass
4**	6674.800	45.28	-0.65	54.0	-8.72	AV	0.00	150	Vertical	Pass
5	9869.250	51.38	-0.80	74.0	-22.62	Peak	208.00	150	Vertical	Pass
5**	9869.250	42.12	-0.80	54.0	-11.88	AV	208.00	150	Vertical	Pass
6	13314.638	55.62	0.88	74.0	-18.38	Peak	131.00	150	Vertical	Pass
6**	13314.638	47.62	0.88	54.0	-6.38	AV	131.00	150	Vertical	Pass

1 GHz to 18 GHz, ANT H 802.11b Middle Channel

No.	Frequency (MHz)	Results (dBuV/m)	Factor (dB)	Limit (dBuV/m)	Over Limit (dB)	Detector	Table (Degree)	Height (cm)	Antenna	Verdict
1	1919.800	45.32	-15.96	74.0	-28.68	Peak	63.00	150	Horizontal	Pass
1**	1919.800	42.71	-15.96	54.0	-11.29	AV	63.00	150	Horizontal	Pass
2	2439.300	103.81	-12.63	74.0	29.81	Peak	186.00	150	Horizontal	N/A
2**	2439.300	100.93	-12.63	54.0	46.93	AV	186.00	150	Horizontal	N/A
3	4874.200	53.97	-3.35	74.0	-20.03	Peak	207.00	150	Horizontal	Pass
3**	4874.200	49.92	-3.35	54.0	-4.08	AV	207.00	150	Horizontal	Pass
4	6999.200	55.02	0.24	74.0	-18.98	Peak	103.00	150	Horizontal	Pass
4**	6999.200	45.77	0.24	54.0	-8.23	AV	103.00	150	Horizontal	Pass
5	9686.974	51.34	0.15	74.0	-22.66	Peak	152.00	150	Horizontal	Pass
5**	9686.974	41.40	0.15	54.0	-12.60	AV	152.00	150	Horizontal	Pass
6	13410.187	56.28	0.50	74.0	-17.72	Peak	319.00	150	Horizontal	Pass
6**	13410.187	46.48	0.50	54.0	-7.52	AV	319.00	150	Horizontal	Pass

1 GHz to 18 GHz, ANT V 802.11b Middle Channel

No.	Frequency (MHz)	Results (dBuV/m)	Factor (dB)	Limit (dBuV/m)	Over Limit (dB)	Detector	Table (Degree)	Height (cm)	Antenna	Verdict
1	1330.100	45.67	-17.41	74.0	-28.33	Peak	23.00	150	Vertical	Pass
1**	1330.100	32.97	-17.41	54.0	-21.03	AV	23.00	150	Vertical	Pass
2	2438.100	99.90	-12.60	74.0	25.90	Peak	155.00	150	Vertical	N/A
2**	2438.100	97.13	-12.60	54.0	43.13	AV	155.00	150	Vertical	N/A
3	4874.000	52.57	-3.34	74.0	-21.43	Peak	21.00	150	Vertical	Pass
3**	4874.000	48.91	-3.34	54.0	-5.09	AV	21.00	150	Vertical	Pass
4	6610.200	53.88	0.17	74.0	-20.12	Peak	46.00	150	Vertical	Pass
4**	6610.200	45.48	0.17	54.0	-8.52	AV	46.00	150	Vertical	Pass
5	8656.862	50.56	-2.00	74.0	-23.44	Peak	341.00	150	Vertical	Pass
5**	8656.862	40.73	-2.00	54.0	-13.27	AV	341.00	150	Vertical	Pass
6	13440.638	56.37	0.48	74.0	-17.63	Peak	0.00	150	Vertical	Pass
6**	13440.638	45.62	0.48	54.0	-8.38	AV	0.00	150	Vertical	Pass

1 GHz to 18 GHz, ANT H 802.11b High Channel

No.	Frequency (MHz)	Results (dBuV/m)	Factor (dB)	Limit (dBuV/m)	Over Limit (dB)	Detector	Table (Degree)	Height (cm)	Antenna	Verdict
1	1920.200	45.59	-15.94	74.0	-28.41	Peak	55.00	150	Horizontal	Pass
1**	1920.200	43.11	-15.94	54.0	-10.89	AV	55.00	150	Horizontal	Pass
2	2463.200	103.61	-12.80	74.0	29.61	Peak	187.00	150	Horizontal	N/A
2**	2463.200	100.12	-12.80	54.0	46.12	AV	187.00	150	Horizontal	N/A
3	4924.200	51.51	-2.60	74.0	-22.49	Peak	209.00	150	Horizontal	Pass
3**	4924.200	48.52	-2.60	54.0	-5.48	AV	209.00	150	Horizontal	Pass
4	6684.600	54.43	-0.26	74.0	-19.57	Peak	286.00	150	Horizontal	Pass
4**	6684.600	45.30	-0.26	54.0	-8.70	AV	286.00	150	Horizontal	Pass
5	10198.725	52.06	0.48	74.0	-21.94	Peak	35.00	150	Horizontal	Pass
5**	10198.725	44.62	0.48	54.0	-9.38	AV	35.00	150	Horizontal	Pass
6	15858.263	56.34	1.02	74.0	-17.66	Peak	132.00	150	Horizontal	Pass
6**	15858.263	46.89	1.02	54.0	-7.11	AV	132.00	150	Horizontal	Pass

1 GHz to 18 GHz, ANT V 802.11b High Channel

No.	Frequency (MHz)	Results (dBuV/m)	Factor (dB)	Limit (dBuV/m)	Over Limit (dB)	Detector	Table (Degree)	Height (cm)	Antenna	Verdict
1	1333.600	43.38	-17.45	74.0	-30.62	Peak	5.00	150	Vertical	Pass
1**	1333.600	29.96	-17.45	54.0	-24.04	AV	5.00	150	Vertical	Pass
2	2463.300	100.13	-12.79	74.0	26.13	Peak	151.00	150	Vertical	N/A
2**	2463.300	97.20	-12.79	54.0	43.20	AV	151.00	150	Vertical	N/A
3	4924.000	50.39	-2.59	74.0	-23.61	Peak	21.00	150	Vertical	Pass
3**	4924.000	46.92	-2.59	54.0	-7.08	AV	21.00	150	Vertical	Pass
4	6682.600	53.78	-0.43	74.0	-20.22	Peak	233.00	150	Vertical	Pass
4**	6682.600	45.52	-0.43	54.0	-8.48	AV	233.00	150	Vertical	Pass
5	10198.438	52.06	0.47	74.0	-21.94	Peak	109.00	150	Vertical	Pass
5**	10198.438	44.28	0.47	54.0	-9.72	AV	109.00	150	Vertical	Pass
6	17197.011	56.64	2.07	74.0	-17.36	Peak	110.00	150	Vertical	Pass
6**	17197.011	49.06	2.07	54.0	-4.94	AV	110.00	150	Vertical	Pass

1 GHz to 18 GHz, ANT H 802.11g Low Channel

No.	Frequency (MHz)	Results (dBuV/m)	Factor (dB)	Limit (dBuV/m)	Over Limit (dB)	Detector	Table (Degree)	Height (cm)	Antenna	Verdict
1	1920.000	44.36	-15.95	74.0	-29.64	Peak	64.00	150	Horizontal	Pass
1**	1920.000	41.53	-15.95	54.0	-12.47	AV	64.00	150	Horizontal	Pass
2	2414.200	108.55	-12.27	74.0	34.55	Peak	260.00	150	Horizontal	N/A
2**	2414.200	100.82	-12.27	54.0	46.82	AV	260.00	150	Horizontal	N/A
3	4819.400	53.89	-3.33	74.0	-20.11	Peak	139.00	150	Horizontal	Pass
3**	4819.400	50.03	-3.33	54.0	-3.97	AV	139.00	150	Horizontal	Pass
4	6680.800	54.01	-0.52	74.0	-19.99	Peak	152.00	150	Horizontal	Pass
4**	6680.800	45.23	-0.52	54.0	-8.77	AV	152.00	150	Horizontal	Pass
5	10196.138	53.12	0.44	74.0	-20.88	Peak	93.00	150	Horizontal	Pass
5**	10196.138	43.15	0.44	54.0	-10.85	AV	93.00	150	Horizontal	Pass
6	17130.864	56.94	2.25	74.0	-17.06	Peak	58.00	150	Horizontal	Pass
6**	17130.864	47.36	2.25	54.0	-6.64	AV	58.00	150	Horizontal	Pass

1 GHz to 18 GHz, ANT V 802.11g Low Channel

No.	Frequency (MHz)	Results (dBuV/m)	Factor (dB)	Limit (dBuV/m)	Over Limit (dB)	Detector	Table (Degree)	Height (cm)	Antenna	Verdict
1	1919.900	43.83	-15.96	74.0	-30.17	Peak	0.00	150	Vertical	Pass
1**	1919.900	38.59	-15.96	54.0	-15.41	AV	0.00	150	Vertical	Pass
2	2416.200	106.87	-12.25	74.0	32.87	Peak	155.00	150	Vertical	N/A
2**	2416.200	98.98	-12.25	54.0	44.98	AV	155.00	150	Vertical	N/A
3	4820.600	55.11	-3.39	74.0	-18.89	Peak	130.00	150	Vertical	Pass
3**	4820.600	50.40	-3.39	54.0	-3.60	AV	130.00	150	Vertical	Pass
4	6678.200	54.53	-0.56	74.0	-19.47	Peak	169.00	150	Vertical	Pass
4**	6678.200	45.20	-0.56	54.0	-8.80	AV	169.00	150	Vertical	Pass
5	10378.125	52.34	0.19	74.0	-21.66	Peak	131.00	150	Vertical	Pass
5**	10378.125	41.98	0.19	54.0	-12.02	AV	131.00	150	Vertical	Pass
6	17418.037	57.17	3.71	74.0	-16.83	Peak	343.00	150	Vertical	Pass
6**	17418.037	48.70	3.71	54.0	-5.30	AV	343.00	150	Vertical	Pass

1 GHz to 18 GHz, ANT H 802.11g Middle Channel

No.	Frequency (MHz)	Results (dBuV/m)	Factor (dB)	Limit (dBuV/m)	Over Limit (dB)	Detector	Table (Degree)	Height (cm)	Antenna	Verdict
1	1918.900	45.55	-15.99	74.0	-28.45	Peak	64.00	150	Horizontal	Pass
1**	1918.900	42.77	-15.99	54.0	-11.23	AV	64.00	150	Horizontal	Pass
2	2439.700	107.88	-12.64	74.0	33.88	Peak	258.00	150	Horizontal	N/A
2**	2439.700	100.25	-12.64	54.0	46.25	AV	258.00	150	Horizontal	N/A
3	4870.200	51.26	-3.39	74.0	-22.74	Peak	204.00	150	Horizontal	Pass
3**	4870.200	46.93	-3.39	54.0	-7.07	AV	204.00	150	Horizontal	Pass
4	6684.200	54.47	-0.30	74.0	-19.53	Peak	0.00	150	Horizontal	Pass
4**	6684.200	44.89	-0.30	54.0	-9.11	AV	0.00	150	Horizontal	Pass
5	10185.500	52.37	0.17	74.0	-21.63	Peak	112.00	150	Horizontal	Pass
5**	10185.500	42.75	0.17	54.0	-11.25	AV	112.00	150	Horizontal	Pass
6	16089.000	56.38	1.45	74.0	-17.62	Peak	152.00	150	Horizontal	Pass
6**	16089.000	46.73	1.45	54.0	-7.27	AV	152.00	150	Horizontal	Pass

1 GHz to 18 GHz, ANT V 802.11g Middle Channel

No.	Frequency (MHz)	Results (dBuV/m)	Factor (dB)	Limit (dBuV/m)	Over Limit (dB)	Detector	Table (Degree)	Height (cm)	Antenna	Verdict
1	1329.800	44.08	-17.42	74.0	-29.92	Peak	15.00	150	Vertical	Pass
1**	1329.800	33.85	-17.42	54.0	-20.15	AV	15.00	150	Vertical	Pass
2	2439.200	106.31	-12.63	74.0	32.31	Peak	260.00	150	Vertical	N/A
2**	2439.200	98.63	-12.63	54.0	44.63	AV	260.00	150	Vertical	N/A
3	4870.400	50.73	-3.39	74.0	-23.27	Peak	134.00	150	Vertical	Pass
3**	4870.400	46.63	-3.39	54.0	-7.37	AV	134.00	150	Vertical	Pass
4	6733.600	54.89	-0.43	74.0	-19.11	Peak	255.00	150	Vertical	Pass
4**	6733.600	44.27	-0.43	54.0	-9.73	AV	255.00	150	Vertical	Pass
5	10198.725	52.79	0.48	74.0	-21.21	Peak	360.00	150	Vertical	Pass
5**	10198.725	44.24	0.48	54.0	-9.76	AV	360.00	150	Vertical	Pass
6	16097.925	57.23	1.25	74.0	-16.77	Peak	123.00	150	Vertical	Pass
6**	16097.925	46.55	1.25	54.0	-7.45	AV	123.00	150	Vertical	Pass

1 GHz to 18 GHz, ANT H 802.11g High Channel

No.	Frequency (MHz)	Results (dBuV/m)	Factor (dB)	Limit (dBuV/m)	Over Limit (dB)	Detector	Table (Degree)	Height (cm)	Antenna	Verdict
1	1920.000	45.23	-15.95	74.0	-28.77	Peak	59.00	150	Horizontal	Pass
1**	1920.000	41.62	-15.95	54.0	-12.38	AV	59.00	150	Horizontal	Pass
2	2460.100	108.09	-12.75	74.0	34.09	Peak	221.00	150	Horizontal	N/A
2**	2460.100	101.06	-12.75	54.0	47.06	AV	221.00	150	Horizontal	N/A
3	4919.400	53.01	-2.43	74.0	-20.99	Peak	137.00	150	Horizontal	Pass
3**	4919.400	42.88	-2.43	54.0	-11.12	AV	137.00	150	Horizontal	Pass
4	6682.000	53.64	-0.47	74.0	-20.36	Peak	85.00	150	Horizontal	Pass
4**	6682.000	45.06	-0.47	54.0	-8.94	AV	85.00	150	Horizontal	Pass
5	10379.275	52.26	0.19	74.0	-21.74	Peak	263.00	150	Horizontal	Pass
5**	10379.275	43.20	0.19	54.0	-10.80	AV	263.00	150	Horizontal	Pass
6	17421.187	56.79	3.72	74.0	-17.21	Peak	229.00	150	Horizontal	Pass
6**	17421.187	47.93	3.72	54.0	-6.07	AV	229.00	150	Horizontal	Pass

1 GHz to 18 GHz, ANT V 802.11g High Channel

No.	Frequency (MHz)	Results (dBuV/m)	Factor (dB)	Limit (dBuV/m)	Over Limit (dB)	Detector	Table (Degree)	Height (cm)	Antenna	Verdict
1	1331.700	43.17	-17.42	74.0	-30.83	Peak	80.00	150	Vertical	Pass
1**	1331.700	29.95	-17.42	54.0	-24.05	AV	80.00	150	Vertical	Pass
2	2459.700	105.91	-12.75	74.0	31.91	Peak	266.00	150	Vertical	N/A
2**	2459.700	98.41	-12.75	54.0	44.41	AV	266.00	150	Vertical	N/A
3	4934.200	51.35	-2.88	74.0	-22.65	Peak	296.00	150	Vertical	Pass
3**	4934.200	42.39	-2.88	54.0	-11.61	AV	296.00	150	Vertical	Pass
4	6684.800	53.98	-0.23	74.0	-20.02	Peak	309.00	150	Vertical	Pass
4**	6684.800	45.57	-0.23	54.0	-8.43	AV	309.00	150	Vertical	Pass
5	10100.688	52.34	0.18	74.0	-21.66	Peak	34.00	150	Vertical	Pass
5**	10100.688	43.83	0.18	54.0	-10.17	AV	34.00	150	Vertical	Pass
6	16068.787	57.04	1.29	74.0	-16.96	Peak	209.00	150	Vertical	Pass
6**	16068.787	46.80	1.29	54.0	-7.20	AV	209.00	150	Vertical	Pass

1 GHz to 18 GHz, ANT H 802.11n20 Low Channel

No.	Frequency (MHz)	Results (dBuV/m)	Factor (dB)	Limit (dBuV/m)	Over Limit (dB)	Detector	Table (Degree)	Height (cm)	Antenna	Verdict
1	1918.600	44.77	-15.98	74.0	-29.23	Peak	76.00	150	Horizontal	Pass
1**	1918.600	34.66	-15.98	54.0	-19.34	AV	76.00	150	Horizontal	Pass
2	2413.800	108.77	-12.26	74.0	34.77	Peak	254.00	150	Horizontal	N/A
2**	2413.800	100.56	-12.26	54.0	46.56	AV	254.00	150	Horizontal	N/A
3	4823.000	53.89	-3.40	74.0	-20.11	Peak	233.00	150	Horizontal	Pass
3**	4823.000	49.65	-3.40	54.0	-4.35	AV	233.00	150	Horizontal	Pass
4	6679.400	54.50	-0.54	74.0	-19.50	Peak	245.00	150	Horizontal	Pass
4**	6679.400	44.50	-0.54	54.0	-9.50	AV	245.00	150	Horizontal	Pass
5	10143.813	52.64	0.04	74.0	-21.36	Peak	1.00	150	Horizontal	Pass
5**	10143.813	42.78	0.04	54.0	-11.22	AV	1.00	150	Horizontal	Pass
6	15835.688	56.23	1.45	74.0	-17.77	Peak	274.00	150	Horizontal	Pass
6**	15835.688	47.37	1.45	54.0	-6.63	AV	274.00	150	Horizontal	Pass

1 GHz to 18 GHz, ANT V 802.11n20 Low Channel

No.	Frequency (MHz)	Results (dBuV/m)	Factor (dB)	Limit (dBuV/m)	Over Limit (dB)	Detector	Table (Degree)	Height (cm)	Antenna	Verdict
1	1331.100	43.33	-17.41	74.0	-30.67	Peak	26.00	150	Vertical	Pass
1**	1331.100	29.57	-17.41	54.0	-24.43	AV	26.00	150	Vertical	Pass
2	2412.300	106.50	-12.26	74.0	32.50	Peak	158.00	150	Vertical	N/A
2**	2412.300	97.44	-12.26	54.0	43.44	AV	158.00	150	Vertical	N/A
3	4823.200	53.91	-3.39	74.0	-20.09	Peak	16.00	150	Vertical	Pass
3**	4823.200	48.80	-3.39	54.0	-5.20	AV	16.00	150	Vertical	Pass
4	6682.200	54.10	-0.46	74.0	-19.90	Peak	4.00	150	Vertical	Pass
4**	6682.200	45.57	-0.46	54.0	-8.43	AV	4.00	150	Vertical	Pass
5	10187.513	51.80	0.22	74.0	-22.20	Peak	319.00	150	Vertical	Pass
5**	10187.513	43.19	0.22	54.0	-10.81	AV	319.00	150	Vertical	Pass
6	17134.801	57.38	2.20	74.0	-16.62	Peak	12.00	150	Vertical	Pass
6**	17134.801	47.10	2.20	54.0	-6.90	AV	12.00	150	Vertical	Pass

1 GHz to 18 GHz, ANT H 802.11n20 Middle Channel

No.	Frequency (MHz)	Results (dBuV/m)	Factor (dB)	Limit (dBuV/m)	Over Limit (dB)	Detector	Table (Degree)	Height (cm)	Antenna	Verdict
1	1919.200	45.77	-15.98	74.0	-28.23	Peak	58.00	150	Horizontal	Pass
1**	1919.200	40.41	-15.98	54.0	-13.59	AV	58.00	150	Horizontal	Pass
2	2437.800	108.54	-12.59	74.0	34.54	Peak	190.00	150	Horizontal	N/A
2**	2437.800	100.33	-12.59	54.0	46.33	AV	190.00	150	Horizontal	N/A
3	4872.600	54.01	-3.29	74.0	-19.99	Peak	205.00	150	Horizontal	Pass
3**	4872.600	46.49	-3.29	54.0	-7.51	AV	205.00	150	Horizontal	Pass
4	6676.600	54.53	-0.59	74.0	-19.47	Peak	260.00	150	Horizontal	Pass
4**	6676.600	44.66	-0.59	54.0	-9.34	AV	260.00	150	Horizontal	Pass
5	9672.600	52.32	0.01	74.0	-21.68	Peak	56.00	150	Horizontal	Pass
5**	9672.600	41.76	0.01	54.0	-12.24	AV	56.00	150	Horizontal	Pass
6	17418.037	56.65	3.71	74.0	-17.35	Peak	208.00	150	Horizontal	Pass
6**	17418.037	48.08	3.71	54.0	-5.92	AV	208.00	150	Horizontal	Pass

1 GHz to 18 GHz, ANT V 802.11n20 Middle Channel

No.	Frequency (MHz)	Results (dBuV/m)	Factor (dB)	Limit (dBuV/m)	Over Limit (dB)	Detector	Table (Degree)	Height (cm)	Antenna	Verdict
1	1164.600	44.13	-18.08	74.0	-29.87	Peak	94.00	150	Vertical	Pass
1**	1164.600	27.90	-18.08	54.0	-26.10	AV	94.00	150	Vertical	Pass
2	2438.800	105.93	-12.62	74.0	31.93	Peak	262.00	150	Vertical	N/A
2**	2438.800	99.26	-12.62	54.0	45.26	AV	262.00	150	Vertical	N/A
3	4867.000	50.83	-3.32	74.0	-23.17	Peak	20.00	150	Vertical	Pass
3**	4867.000	45.41	-3.32	54.0	-8.59	AV	20.00	150	Vertical	Pass
4	6675.200	54.31	-0.64	74.0	-19.69	Peak	101.00	150	Vertical	Pass
4**	6675.200	44.80	-0.64	54.0	-9.20	AV	101.00	150	Vertical	Pass
5	9986.263	52.78	-0.89	74.0	-21.22	Peak	54.00	150	Vertical	Pass
5**	9986.263	42.41	-0.89	54.0	-11.59	AV	54.00	150	Vertical	Pass
6	17477.626	56.95	2.78	74.0	-17.05	Peak	81.00	150	Vertical	Pass
6**	17477.626	46.74	2.78	54.0	-7.26	AV	81.00	150	Vertical	Pass

1 GHz to 18 GHz, ANT H 802.11n20 High Channel

No.	Frequency (MHz)	Results (dBuV/m)	Factor (dB)	Limit (dBuV/m)	Over Limit (dB)	Detector	Table (Degree)	Height (cm)	Antenna	Verdict
1	1919.500	46.05	-15.97	74.0	-27.95	Peak	58.00	150	Horizontal	Pass
1**	1919.500	43.48	-15.97	54.0	-10.52	AV	58.00	150	Horizontal	Pass
2	2459.700	108.30	-12.75	74.0	34.30	Peak	209.00	150	Horizontal	N/A
2**	2459.700	101.05	-12.75	54.0	47.05	AV	209.00	150	Horizontal	N/A
3	4922.200	51.71	-2.54	74.0	-22.29	Peak	268.00	150	Horizontal	Pass
3**	4922.200	43.79	-2.54	54.0	-10.21	AV	268.00	150	Horizontal	Pass
4	6602.800	53.82	-0.11	74.0	-20.18	Peak	94.00	150	Horizontal	Pass
4**	6602.800	44.76	-0.11	54.0	-9.24	AV	94.00	150	Horizontal	Pass
5	10199.300	52.73	0.48	74.0	-21.27	Peak	129.00	150	Horizontal	Pass
5**	10199.300	44.05	0.48	54.0	-9.95	AV	129.00	150	Horizontal	Pass
6	17418.562	57.23	3.72	74.0	-16.77	Peak	42.00	150	Horizontal	Pass
6**	17418.562	48.15	3.72	54.0	-5.85	AV	42.00	150	Horizontal	Pass

1 GHz to 18 GHz, ANT V 802.11n20 High Channel

No.	Frequency (MHz)	Results (dBuV/m)	Factor (dB)	Limit (dBuV/m)	Over Limit (dB)	Detector	Table (Degree)	Height (cm)	Antenna	Verdict
1	1791.600	44.86	-16.91	74.0	-29.14	Peak	96.00	150	Vertical	Pass
1**	1791.600	29.80	-16.91	54.0	-24.20	AV	96.00	150	Vertical	Pass
2	2462.500	106.07	-12.78	74.0	32.07	Peak	155.00	150	Vertical	N/A
2**	2462.500	98.17	-12.78	54.0	44.17	AV	155.00	150	Vertical	N/A
3	4801.000	51.24	-2.57	74.0	-22.76	Peak	66.00	150	Vertical	Pass
3**	4801.000	42.05	-2.57	54.0	-11.95	AV	66.00	150	Vertical	Pass
4	6685.600	54.36	-0.19	74.0	-19.64	Peak	350.00	150	Vertical	Pass
4**	6685.600	46.18	-0.19	54.0	-7.82	AV	350.00	150	Vertical	Pass
5	9603.313	51.75	0.02	74.0	-22.25	Peak	71.00	150	Vertical	Pass
5**	9603.313	41.56	0.02	54.0	-12.44	AV	71.00	150	Vertical	Pass
6	17414.887	56.93	3.63	74.0	-17.07	Peak	211.00	150	Vertical	Pass
6**	17414.887	47.73	3.63	54.0	-6.27	AV	211.00	150	Vertical	Pass

1 GHz to 18 GHz, ANT H 802.11n40 Low Channel

No.	Frequency (MHz)	Results (dBuV/m)	Factor (dB)	Limit (dBuV/m)	Over Limit (dB)	Detector	Table (Degree)	Height (cm)	Antenna	Verdict
1	1918.900	44.68	-15.99	74.0	-29.32	Peak	62.00	150	Horizontal	Pass
1**	1918.900	33.47	-15.99	54.0	-20.53	AV	62.00	150	Horizontal	Pass
2	2436.600	106.16	-12.69	74.0	32.16	Peak	190.00	150	Horizontal	N/A
2**	2436.600	98.70	-12.69	54.0	44.70	AV	190.00	150	Horizontal	N/A
3	4852.600	52.53	-3.23	74.0	-21.47	Peak	238.00	150	Horizontal	Pass
3**	4852.600	44.71	-3.23	54.0	-9.29	AV	238.00	150	Horizontal	Pass
4	6270.000	53.80	-0.34	74.0	-20.20	Peak	224.00	150	Horizontal	Pass
4**	6270.000	45.45	-0.34	54.0	-8.55	AV	224.00	150	Horizontal	Pass
5	10196.138	53.29	0.44	74.0	-20.71	Peak	75.00	150	Horizontal	Pass
5**	10196.138	43.72	0.44	54.0	-10.28	AV	75.00	150	Horizontal	Pass
6	16402.426	56.30	1.39	74.0	-17.70	Peak	0.00	150	Horizontal	Pass
6**	16402.426	46.36	1.39	54.0	-7.64	AV	0.00	150	Horizontal	Pass

1 GHz to 18 GHz, ANT V 802.11n40 Low Channel

No.	Frequency (MHz)	Results (dBuV/m)	Factor (dB)	Limit (dBuV/m)	Over Limit (dB)	Detector	Table (Degree)	Height (cm)	Antenna	Verdict
1	1330.400	47.06	-17.40	74.0	-26.94	Peak	93.00	150	Vertical	Pass
1**	1330.400	36.68	-17.40	54.0	-17.32	AV	93.00	150	Vertical	Pass
2	2438.700	104.30	-12.62	74.0	30.30	Peak	265.00	150	Vertical	N/A
2**	2438.700	96.43	-12.62	54.0	42.43	AV	265.00	150	Vertical	N/A
3	4862.600	52.54	-3.37	74.0	-21.46	Peak	35.00	150	Vertical	Pass
3**	4862.600	45.61	-3.37	54.0	-8.39	AV	35.00	150	Vertical	Pass
4	6697.600	53.93	-0.54	74.0	-20.07	Peak	113.00	150	Vertical	Pass
4**	6697.600	43.88	-0.54	54.0	-10.12	AV	113.00	150	Vertical	Pass
5	10489.099	51.90	-0.80	74.0	-22.10	Peak	128.00	150	Vertical	Pass
5**	10489.099	42.22	-0.80	54.0	-11.78	AV	128.00	150	Vertical	Pass
6	17189.136	56.80	2.37	74.0	-17.20	Peak	139.00	150	Vertical	Pass
6**	17189.136	49.72	2.37	54.0	-4.28	AV	139.00	150	Vertical	Pass

1 GHz to 18 GHz, ANT H 802.11n40 Middle Channel

No.	Frequency (MHz)	Results (dBuV/m)	Factor (dB)	Limit (dBuV/m)	Over Limit (dB)	Detector	Table (Degree)	Height (cm)	Antenna	Verdict
1	1919.400	45.30	-15.98	74.0	-28.70	Peak	79.00	150	Horizontal	Pass
1**	1919.400	41.19	-15.98	54.0	-12.81	AV	79.00	150	Horizontal	Pass
2	2445.600	106.33	-12.71	74.0	32.33	Peak	228.00	150	Horizontal	N/A
2**	2445.600	98.73	-12.71	54.0	44.73	AV	228.00	150	Horizontal	N/A
3	4890.200	51.74	-3.20	74.0	-22.26	Peak	140.00	150	Horizontal	Pass
3**	4890.200	43.74	-3.20	54.0	-10.26	AV	140.00	150	Horizontal	Pass
4	6599.400	53.28	-0.53	74.0	-20.72	Peak	59.00	150	Horizontal	Pass
4**	6599.400	45.20	-0.53	54.0	-8.80	AV	59.00	150	Horizontal	Pass
5	9816.063	52.27	-0.01	74.0	-21.73	Peak	167.00	150	Horizontal	Pass
5**	9816.063	43.06	-0.01	54.0	-10.94	AV	167.00	150	Horizontal	Pass
6	16132.050	56.92	1.04	74.0	-17.08	Peak	100.00	150	Horizontal	Pass
6**	16132.050	46.77	1.04	54.0	-7.23	AV	100.00	150	Horizontal	Pass

1 GHz to 18 GHz, ANT V 802.11n40 Middle Channel

No.	Frequency (MHz)	Results (dBuV/m)	Factor (dB)	Limit (dBuV/m)	Over Limit (dB)	Detector	Table (Degree)	Height (cm)	Antenna	Verdict
1	1920.200	43.40	-15.94	74.0	-30.60	Peak	322.00	150	Vertical	Pass
1**	1920.200	39.34	-15.94	54.0	-14.66	AV	322.00	150	Vertical	Pass
2	2456.100	103.80	-12.72	74.0	29.80	Peak	158.00	150	Vertical	N/A
2**	2456.100	95.18	-12.72	54.0	41.18	AV	158.00	150	Vertical	N/A
3	4910.600	51.45	-2.46	74.0	-22.55	Peak	42.00	150	Vertical	Pass
3**	4910.600	42.72	-2.46	54.0	-11.28	AV	42.00	150	Vertical	Pass
4	6611.200	54.05	0.19	74.0	-19.95	Peak	14.00	150	Vertical	Pass
4**	6611.200	45.77	0.19	54.0	-8.23	AV	14.00	150	Vertical	Pass
5	10198.438	52.69	0.47	74.0	-21.31	Peak	287.00	150	Vertical	Pass
5**	10198.438	44.23	0.47	54.0	-9.77	AV	287.00	150	Vertical	Pass
6	15851.963	56.90	1.28	74.0	-17.10	Peak	100.00	150	Vertical	Pass
6**	15851.963	47.33	1.28	54.0	-6.67	AV	100.00	150	Vertical	Pass

1 GHz to 18 GHz, ANT H 802.11n40 High Channel

No.	Frequency (MHz)	Results (dBuV/m)	Factor (dB)	Limit (dBuV/m)	Over Limit (dB)	Detector	Table (Degree)	Height (cm)	Antenna	Verdict
1	1919.400	44.93	-15.98	74.0	-29.07	Peak	57.00	150	Horizontal	Pass
1**	1919.400	38.92	-15.98	54.0	-15.08	AV	57.00	150	Horizontal	Pass
2	2455.300	106.43	-12.68	74.0	32.43	Peak	251.00	150	Horizontal	N/A
2**	2455.300	98.87	-12.68	54.0	44.87	AV	251.00	150	Horizontal	N/A
3	4793.800	51.21	-2.60	74.0	-22.79	Peak	269.00	150	Horizontal	Pass
3**	4793.800	41.92	-2.60	54.0	-12.08	AV	269.00	150	Horizontal	Pass
4	6621.000	54.62	-0.23	74.0	-19.38	Peak	47.00	150	Horizontal	Pass
4**	6621.000	43.70	-0.23	54.0	-10.30	AV	47.00	150	Horizontal	Pass
5	10148.125	52.16	0.01	74.0	-21.84	Peak	360.00	150	Horizontal	Pass
5**	10148.125	42.96	0.01	54.0	-11.04	AV	360.00	150	Horizontal	Pass
6	17189.401	56.52	2.36	74.0	-17.48	Peak	94.00	150	Horizontal	Pass
6**	17189.401	47.62	2.36	54.0	-6.38	AV	94.00	150	Horizontal	Pass

1 GHz to 18 GHz, ANT V 802.11n40 High Channel

No.	Frequency (MHz)	Results (dBuV/m)	Factor (dB)	Limit (dBuV/m)	Over Limit (dB)	Detector	Table (Degree)	Height (cm)	Antenna	Verdict
1	1329.100	44.55	-17.45	74.0	-29.45	Peak	6.00	150	Vertical	Pass
1**	1329.100	32.54	-17.45	54.0	-21.46	AV	6.00	150	Vertical	Pass
2	2460.400	103.38	-12.75	74.0	29.38	Peak	155.00	150	Vertical	N/A
2**	2460.400	95.41	-12.75	54.0	41.41	AV	155.00	150	Vertical	N/A
3	4912.800	51.36	-2.25	74.0	-22.64	Peak	38.00	150	Vertical	Pass
3**	4912.800	42.89	-2.25	54.0	-11.11	AV	38.00	150	Vertical	Pass
4	6681.400	53.93	-0.50	74.0	-20.07	Peak	25.00	150	Vertical	Pass
4**	6681.400	45.52	-0.50	54.0	-8.48	AV	25.00	150	Vertical	Pass
5	9977.062	52.23	-0.74	74.0	-21.77	Peak	17.00	150	Vertical	Pass
5**	9977.062	42.12	-0.74	54.0	-11.88	AV	17.00	150	Vertical	Pass
6	17177.325	57.14	2.58	74.0	-16.86	Peak	233.00	150	Vertical	Pass
6**	17177.325	47.77	2.58	54.0	-6.23	AV	233.00	150	Vertical	Pass

MIMO**1 GHz to 18 GHz, ANT H 802.11n20 Low Channel**

No.	Frequency (MHz)	Results (dBUV/m)	Factor (dB)	Limit (dBUV/m)	Over Limit (dB)	Detector	Table (Degree)	Height (cm)	Antenna	Verdict
1	1918.700	44.03	-15.98	74.0	-29.97	Peak	52.00	150	Horizontal	Pass
1**	1918.700	40.41	-15.98	54.0	-13.59	AV	52.00	150	Horizontal	Pass
2	2410.200	109.44	-12.24	74.0	35.44	Peak	86.00	150	Horizontal	N/A
2**	2410.200	101.78	-12.24	54.0	47.78	AV	86.00	150	Horizontal	N/A
3	4825.200	55.80	-3.44	74.0	-18.20	Peak	273.00	150	Horizontal	Pass
3**	4825.200	50.92	-3.44	54.0	-3.08	AV	273.00	150	Horizontal	Pass
4	6615.400	54.83	0.15	74.0	-19.17	Peak	65.00	150	Horizontal	Pass
4**	6615.400	44.57	0.15	54.0	-9.43	AV	65.00	150	Horizontal	Pass
5	10200.450	51.99	0.48	74.0	-22.01	Peak	112.00	150	Horizontal	Pass
5**	10200.450	43.66	0.48	54.0	-10.34	AV	112.00	150	Horizontal	Pass
6	15225.113	56.01	0.74	74.0	-17.99	Peak	58.00	150	Horizontal	Pass
6**	15225.113	46.77	0.74	54.0	-7.23	AV	58.00	150	Horizontal	Pass

1 GHz to 18 GHz, ANT V 802.11n20 Low Channel

No.	Frequency (MHz)	Results (dBUV/m)	Factor (dB)	Limit (dBUV/m)	Over Limit (dB)	Detector	Table (Degree)	Height (cm)	Antenna	Verdict
1	1331.400	44.47	-17.41	74.0	-29.53	Peak	21.00	150	Vertical	Pass
1**	1331.400	38.41	-17.41	54.0	-15.59	AV	21.00	150	Vertical	Pass
2	2409.000	107.54	-12.26	74.0	33.54	Peak	217.00	150	Vertical	N/A
2**	2409.000	100.55	-12.26	54.0	46.55	AV	217.00	150	Vertical	N/A
3	4822.000	54.60	-3.44	74.0	-19.40	Peak	91.00	150	Vertical	Pass
3**	4822.000	50.62	-3.44	54.0	-3.38	AV	91.00	150	Vertical	Pass
4	6675.400	54.39	-0.63	74.0	-19.61	Peak	191.00	150	Vertical	Pass
4**	6675.400	44.71	-0.63	54.0	-9.29	AV	191.00	150	Vertical	Pass
5	10175.150	52.30	-0.12	74.0	-21.70	Peak	154.00	150	Vertical	Pass
5**	10175.150	42.44	-0.12	54.0	-11.56	AV	154.00	150	Vertical	Pass
6	17206.989	57.10	1.58	74.0	-16.90	Peak	299.00	150	Vertical	Pass
6**	17206.989	47.63	1.58	54.0	-6.37	AV	299.00	150	Vertical	Pass

1 GHz to 18 GHz, ANT H 802.11n20 Middle Channel

No.	Frequency (MHz)	Results (dBuV/m)	Factor (dB)	Limit (dBuV/m)	Over Limit (dB)	Detector	Table (Degree)	Height (cm)	Antenna	Verdict
1	1917.700	43.66	-15.98	74.0	-30.34	Peak	82.00	150	Horizontal	Pass
1**	1917.700	37.48	-15.98	54.0	-16.52	AV	82.00	150	Horizontal	Pass
2	2441.900	108.92	-12.92	74.0	34.92	Peak	146.00	150	Horizontal	N/A
2**	2441.900	102.07	-12.92	54.0	48.07	AV	146.00	150	Horizontal	N/A
3	4872.400	52.72	-3.30	74.0	-21.28	Peak	218.00	150	Horizontal	Pass
3**	4872.400	47.51	-3.30	54.0	-6.49	AV	218.00	150	Horizontal	Pass
4	6681.000	53.65	-0.52	74.0	-20.35	Peak	127.00	150	Horizontal	Pass
4**	6681.000	45.44	-0.52	54.0	-8.56	AV	127.00	150	Horizontal	Pass
5	11218.201	52.14	-0.20	74.0	-21.86	Peak	212.00	150	Horizontal	Pass
5**	11218.201	42.42	-0.20	54.0	-11.58	AV	212.00	150	Horizontal	Pass
6	17188.350	56.82	2.40	74.0	-17.18	Peak	147.00	150	Horizontal	Pass
6**	17188.350	48.48	2.40	54.0	-5.52	AV	147.00	150	Horizontal	Pass

1 GHz to 18 GHz, ANT V 802.11n20 Middle Channel

No.	Frequency (MHz)	Results (dBuV/m)	Factor (dB)	Limit (dBuV/m)	Over Limit (dB)	Detector	Table (Degree)	Height (cm)	Antenna	Verdict
1	1333.100	45.23	-17.44	74.0	-28.77	Peak	20.00	150	Vertical	Pass
1**	1333.100	30.79	-17.44	54.0	-23.21	AV	20.00	150	Vertical	Pass
2	2432.500	107.97	-12.85	74.0	33.97	Peak	270.00	150	Vertical	N/A
2**	2432.500	100.48	-12.85	54.0	46.48	AV	270.00	150	Vertical	N/A
3	4872.800	52.33	-3.29	74.0	-21.67	Peak	21.00	150	Vertical	Pass
3**	4872.800	48.66	-3.29	54.0	-5.34	AV	21.00	150	Vertical	Pass
4	6690.400	53.93	-0.28	74.0	-20.07	Peak	0.00	150	Vertical	Pass
4**	6690.400	45.31	-0.28	54.0	-8.69	AV	0.00	150	Vertical	Pass
5	10373.526	51.82	0.17	74.0	-22.18	Peak	210.00	150	Vertical	Pass
5**	10373.526	42.70	0.17	54.0	-11.30	AV	210.00	150	Vertical	Pass
6	17278.124	56.66	1.62	74.0	-17.34	Peak	228.00	150	Vertical	Pass
6**	17278.124	46.32	1.62	54.0	-7.68	AV	228.00	150	Vertical	Pass

1 GHz to 18 GHz, ANT H 802.11n20 High Channel

No.	Frequency (MHz)	Results (dBuV/m)	Factor (dB)	Limit (dBuV/m)	Over Limit (dB)	Detector	Table (Degree)	Height (cm)	Antenna	Verdict
1	1917.400	43.42	-15.98	74.0	-30.58	Peak	85.00	150	Horizontal	Pass
1**	1917.400	33.43	-15.98	54.0	-20.57	AV	85.00	150	Horizontal	Pass
2	2464.200	109.04	-12.76	74.0	35.04	Peak	21.00	150	Horizontal	N/A
2**	2464.200	102.18	-12.76	54.0	48.18	AV	21.00	150	Horizontal	N/A
3	4918.600	49.73	-2.35	74.0	-24.27	Peak	139.00	150	Horizontal	Pass
3**	4918.600	46.47	-2.35	54.0	-7.53	AV	139.00	150	Horizontal	Pass
4	6273.000	55.35	-0.18	74.0	-18.65	Peak	284.00	150	Horizontal	Pass
4**	6273.000	44.33	-0.18	54.0	-9.67	AV	284.00	150	Horizontal	Pass
5	9753.099	51.76	-0.40	74.0	-22.24	Peak	237.00	150	Horizontal	Pass
5**	9753.099	42.89	-0.40	54.0	-11.11	AV	237.00	150	Horizontal	Pass
6	15847.500	56.39	1.35	74.0	-17.61	Peak	12.00	150	Horizontal	Pass
6**	15847.500	47.21	1.35	54.0	-6.79	AV	12.00	150	Horizontal	Pass

1 GHz to 18 GHz, ANT V 802.11n20 High Channel

No.	Frequency (MHz)	Results (dBuV/m)	Factor (dB)	Limit (dBuV/m)	Over Limit (dB)	Detector	Table (Degree)	Height (cm)	Antenna	Verdict
1	1920.300	43.32	-15.94	74.0	-30.68	Peak	0.00	150	Vertical	Pass
1**	1920.300	38.15	-15.94	54.0	-15.85	AV	0.00	150	Vertical	Pass
2	2463.600	108.61	-12.78	74.0	34.61	Peak	151.00	150	Vertical	N/A
2**	2463.600	100.93	-12.78	54.0	46.93	AV	151.00	150	Vertical	N/A
3	4921.000	52.12	-2.50	74.0	-21.88	Peak	0.00	150	Vertical	Pass
3**	4921.000	43.23	-2.50	54.0	-10.77	AV	0.00	150	Vertical	Pass
4	6680.200	54.40	-0.53	74.0	-19.60	Peak	70.00	150	Vertical	Pass
4**	6680.200	45.39	-0.53	54.0	-8.61	AV	70.00	150	Vertical	Pass
5	10152.724	52.09	-0.08	74.0	-21.91	Peak	328.00	150	Vertical	Pass
5**	10152.724	43.77	-0.08	54.0	-10.23	AV	328.00	150	Vertical	Pass
6	17202.000	56.49	1.79	74.0	-17.51	Peak	211.00	150	Vertical	Pass
6**	17202.000	47.40	1.79	54.0	-6.60	AV	211.00	150	Vertical	Pass

1 GHz to 18 GHz, ANT H 802.11n40 Low Channel

No.	Frequency (MHz)	Results (dBuV/m)	Factor (dB)	Limit (dBuV/m)	Over Limit (dB)	Detector	Table (Degree)	Height (cm)	Antenna	Verdict
1	1917.100	44.56	-15.98	74.0	-29.44	Peak	62.00	150	Horizontal	Pass
1**	1917.100	32.98	-15.98	54.0	-21.02	AV	62.00	150	Horizontal	Pass
2	2438.600	107.89	-12.61	74.0	33.89	Peak	140.00	150	Horizontal	N/A
2**	2438.600	100.06	-12.61	54.0	46.06	AV	140.00	150	Horizontal	N/A
3	4857.400	52.55	-3.27	74.0	-21.45	Peak	145.00	150	Horizontal	Pass
3**	4857.400	44.27	-3.27	54.0	-9.73	AV	145.00	150	Horizontal	Pass
4	6682.400	53.62	-0.45	74.0	-20.38	Peak	0.00	150	Horizontal	Pass
4**	6682.400	45.19	-0.45	54.0	-8.81	AV	0.00	150	Horizontal	Pass
5	10262.263	52.35	0.53	74.0	-21.65	Peak	333.00	150	Horizontal	Pass
5**	10262.263	42.30	0.53	54.0	-11.70	AV	333.00	150	Horizontal	Pass
6	17188.088	56.67	2.41	74.0	-17.33	Peak	255.00	150	Horizontal	Pass
6**	17188.088	47.48	2.41	54.0	-6.52	AV	255.00	150	Horizontal	Pass

1 GHz to 18 GHz, ANT V 802.11n40 Low Channel

No.	Frequency (MHz)	Results (dBuV/m)	Factor (dB)	Limit (dBuV/m)	Over Limit (dB)	Detector	Table (Degree)	Height (cm)	Antenna	Verdict
1	1329.800	42.69	-17.42	74.0	-31.31	Peak	35.00	150	Vertical	Pass
1**	1329.800	31.69	-17.42	54.0	-22.31	AV	35.00	150	Vertical	Pass
2	2428.900	106.73	-12.80	74.0	32.73	Peak	260.00	150	Vertical	N/A
2**	2428.900	98.98	-12.80	54.0	44.98	AV	260.00	150	Vertical	N/A
3	4862.800	53.78	-3.38	74.0	-20.22	Peak	21.00	150	Vertical	Pass
3**	4862.800	46.16	-3.38	54.0	-7.84	AV	21.00	150	Vertical	Pass
4	6680.800	54.29	-0.52	74.0	-19.71	Peak	0.00	150	Vertical	Pass
4**	6680.800	44.95	-0.52	54.0	-9.05	AV	0.00	150	Vertical	Pass
5	10198.725	52.21	0.48	74.0	-21.79	Peak	193.00	150	Vertical	Pass
5**	10198.725	43.38	0.48	54.0	-10.62	AV	193.00	150	Vertical	Pass
6	15853.537	56.37	1.23	74.0	-17.63	Peak	213.00	150	Vertical	Pass
6**	15853.537	47.43	1.23	54.0	-6.57	AV	213.00	150	Vertical	Pass

1 GHz to 18 GHz, ANT H 802.11n40 Middle Channel

No.	Frequency (MHz)	Results (dBuV/m)	Factor (dB)	Limit (dBuV/m)	Over Limit (dB)	Detector	Table (Degree)	Height (cm)	Antenna	Verdict
1	1919.100	44.61	-15.99	74.0	-29.39	Peak	62.00	150	Horizontal	Pass
1**	1919.100	42.78	-15.99	54.0	-11.22	AV	62.00	150	Horizontal	Pass
2	2453.400	107.95	-12.68	74.0	33.95	Peak	260.00	150	Horizontal	N/A
2**	2453.400	99.70	-12.68	54.0	45.70	AV	260.00	150	Horizontal	N/A
3	4894.200	51.40	-3.17	74.0	-22.60	Peak	138.00	150	Horizontal	Pass
3**	4894.200	43.13	-3.17	54.0	-10.87	AV	138.00	150	Horizontal	Pass
4	6684.800	53.89	-0.23	74.0	-20.11	Peak	297.00	150	Horizontal	Pass
4**	6684.800	45.62	-0.23	54.0	-8.38	AV	297.00	150	Horizontal	Pass
5	10364.037	53.00	0.10	74.0	-21.00	Peak	217.00	150	Horizontal	Pass
5**	10364.037	42.27	0.10	54.0	-11.73	AV	217.00	150	Horizontal	Pass
6	17205.150	56.69	1.64	74.0	-17.31	Peak	231.00	150	Horizontal	Pass
6**	17205.150	48.52	1.64	54.0	-5.48	AV	231.00	150	Horizontal	Pass

1 GHz to 18 GHz, ANT V 802.11n40 Middle Channel

No.	Frequency (MHz)	Results (dBuV/m)	Factor (dB)	Limit (dBuV/m)	Over Limit (dB)	Detector	Table (Degree)	Height (cm)	Antenna	Verdict
1	1332.500	42.76	-17.43	74.0	-31.24	Peak	0.00	150	Vertical	Pass
1**	1332.500	34.63	-17.43	54.0	-19.37	AV	0.00	150	Vertical	Pass
2	2448.000	106.65	-12.69	74.0	32.65	Peak	93.00	150	Vertical	N/A
2**	2448.000	98.28	-12.69	54.0	44.28	AV	93.00	150	Vertical	N/A
3	4872.400	51.37	-3.30	74.0	-22.63	Peak	11.00	150	Vertical	Pass
3**	4872.400	41.65	-3.30	54.0	-12.35	AV	11.00	150	Vertical	Pass
4	6677.800	53.80	-0.57	74.0	-20.20	Peak	239.00	150	Vertical	Pass
4**	6677.800	45.07	-0.57	54.0	-8.93	AV	239.00	150	Vertical	Pass
5	10206.200	52.37	0.31	74.0	-21.63	Peak	334.00	150	Vertical	Pass
5**	10206.200	42.96	0.31	54.0	-11.04	AV	334.00	150	Vertical	Pass
6	16102.912	56.42	1.07	74.0	-17.58	Peak	168.00	150	Vertical	Pass
6**	16102.912	47.00	1.07	54.0	-7.00	AV	168.00	150	Vertical	Pass

1 GHz to 18 GHz, ANT H 802.11n40 High Channel

No.	Frequency (MHz)	Results (dBuV/m)	Factor (dB)	Limit (dBuV/m)	Over Limit (dB)	Detector	Table (Degree)	Height (cm)	Antenna	Verdict
1	1919.300	45.07	-15.98	74.0	-28.93	Peak	65.00	150	Horizontal	Pass
1**	1919.300	41.40	-15.98	54.0	-12.60	AV	65.00	150	Horizontal	Pass
2	2466.900	107.77	-12.66	74.0	33.77	Peak	132.00	150	Horizontal	N/A
2**	2466.900	101.45	-12.66	54.0	47.45	AV	132.00	150	Horizontal	N/A
3	4935.000	51.45	-2.92	74.0	-22.55	Peak	125.00	150	Horizontal	Pass
3**	4935.000	42.20	-2.92	54.0	-11.80	AV	125.00	150	Horizontal	Pass
4	6599.400	53.79	-0.53	74.0	-20.21	Peak	336.00	150	Horizontal	Pass
4**	6599.400	44.62	-0.53	54.0	-9.38	AV	336.00	150	Horizontal	Pass
5	10136.337	51.95	-0.03	74.0	-22.05	Peak	293.00	150	Horizontal	Pass
5**	10136.337	42.72	-0.03	54.0	-11.28	AV	293.00	150	Horizontal	Pass
6	17202.526	57.55	1.77	74.0	-16.45	Peak	10.00	150	Horizontal	Pass
6**	17202.526	47.67	1.77	54.0	-6.33	AV	10.00	150	Horizontal	Pass

1 GHz to 18 GHz, ANT V 802.11n40 High Channel

No.	Frequency (MHz)	Results (dBuV/m)	Factor (dB)	Limit (dBuV/m)	Over Limit (dB)	Detector	Table (Degree)	Height (cm)	Antenna	Verdict
1	1919.700	42.56	-15.96	74.0	-31.44	Peak	0.00	150	Vertical	Pass
1**	1919.700	37.57	-15.96	54.0	-16.43	AV	0.00	150	Vertical	Pass
2	2466.500	107.13	-12.67	74.0	33.13	Peak	146.00	150	Vertical	N/A
2**	2466.500	98.73	-12.67	54.0	44.73	AV	146.00	150	Vertical	N/A
3	4800.200	50.97	-2.55	74.0	-23.03	Peak	250.00	150	Vertical	Pass
3**	4800.200	44.31	-2.55	54.0	-9.69	AV	250.00	150	Vertical	Pass
4	6685.200	54.40	-0.19	74.0	-19.60	Peak	350.00	150	Vertical	Pass
4**	6685.200	45.81	-0.19	54.0	-8.19	AV	350.00	150	Vertical	Pass
5	10145.825	52.24	0.04	74.0	-21.76	Peak	43.00	150	Vertical	Pass
5**	10145.825	43.17	0.04	54.0	-10.83	AV	43.00	150	Vertical	Pass
6	17186.775	56.90	2.46	74.0	-17.10	Peak	111.00	150	Vertical	Pass
6**	17186.775	47.79	2.46	54.0	-6.21	AV	111.00	150	Vertical	Pass

A.7 Band Edge (Restricted-band band-edge)

Note ¹: The lowest and highest channels are tested to verify the band edge emissions. Please refer to the following the plots for emissions values.

Note ²: The test data all are tested in the vertical and horizontal antenna which the trace is max hold. So these plots have shown the worst case.

Note ³: According the ANSI C63.10-2013, where limits are specified for both average and peak (or quasi-peak) detector functions, if the peak (or quasi-peak) measured value complies with the average limit, it is unnecessary to perform an average measurement.

Note ⁴: All antenna were tested, but only the worst case has been reported in this report.

Test Data and Plots

Main Antenna

802.11b LOW CHANNEL

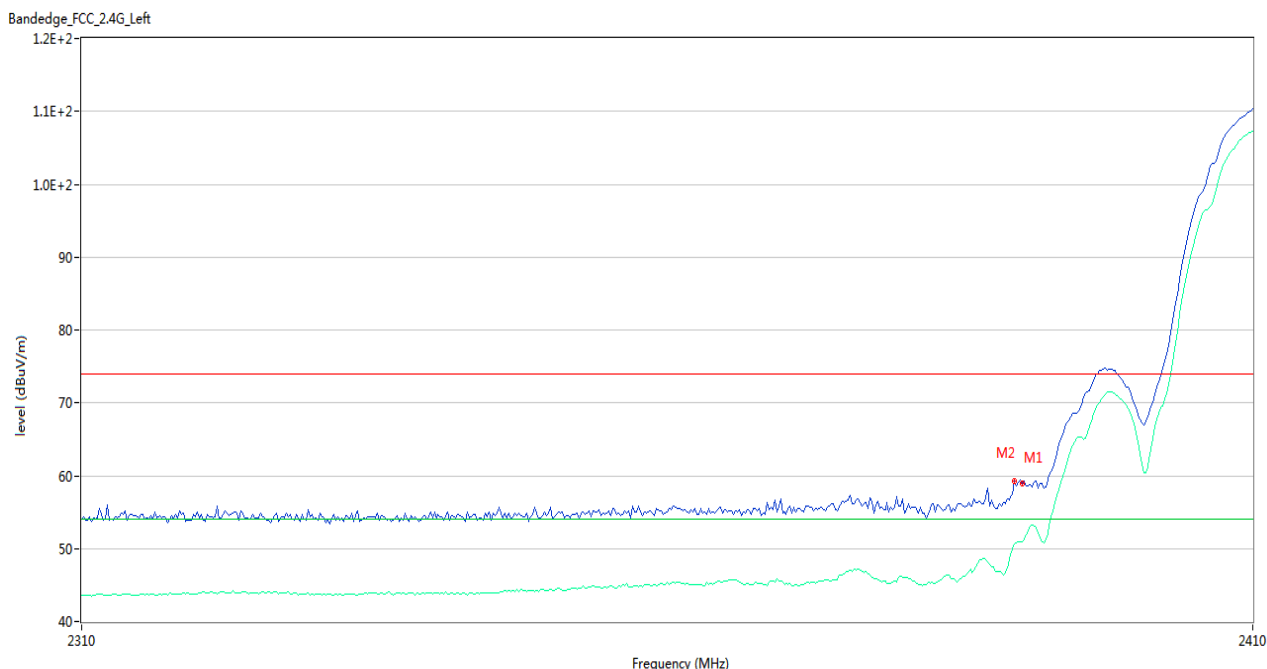

No.	Frequency (MHz)	Results (dBuV/m)	Factor (dB)	Limit (dBuV/m)	Over Limit (dB)	Detector	Table (Degree)	Height (cm)	Antenna	Verdict
1	2390.000	58.88	-0.50	74.0	-15.12	Peak	185.00	150	Horizontal	Pass
1**	2390.000	50.86	-0.50	54.0	-3.14	AV	185.00	150	Horizontal	Pass
2	2389.333	59.21	-0.49	74.0	-14.79	Peak	185.00	150	Horizontal	Pass
2**	2389.333	50.66	-0.49	54.0	-3.34	AV	185.00	150	Horizontal	Pass

802.11b HIGH CHANNEL

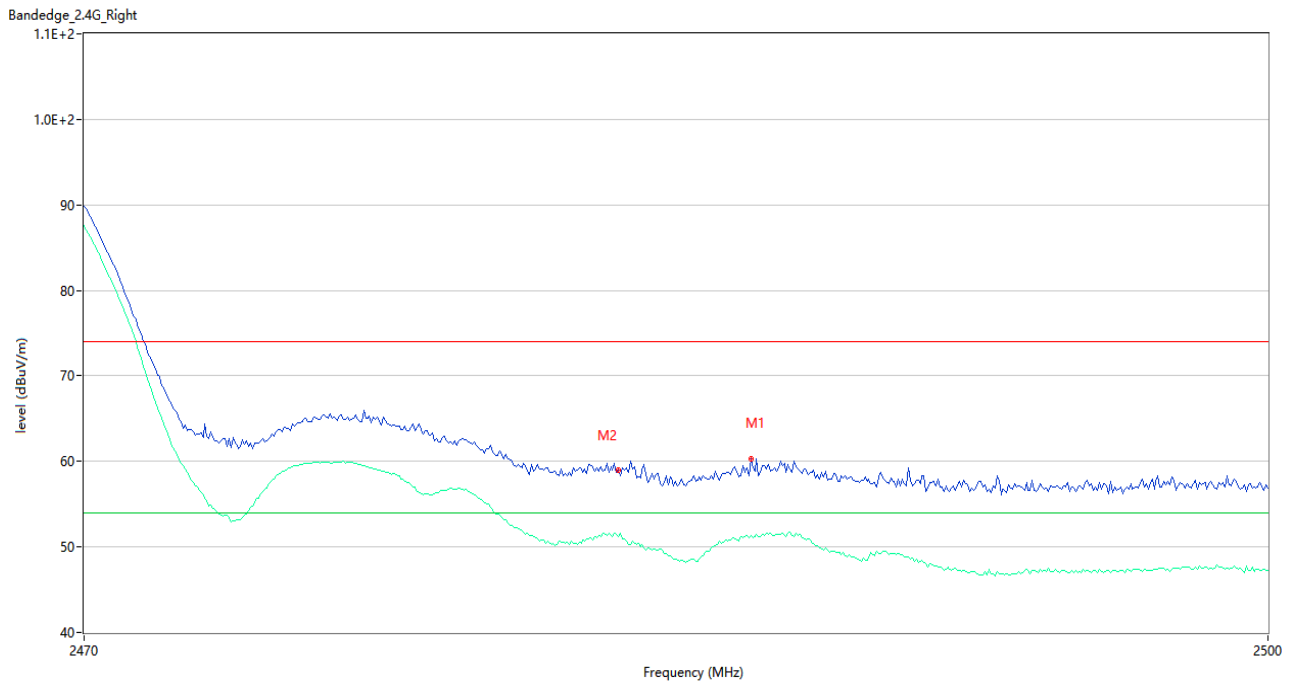

No.	Frequency (MHz)	Results (dBuV/m)	Factor (dB)	Limit (dBuV/m)	Over Limit (dB)	Detector	Table (Degree)	Height (cm)	Antenna	Verdict
1	2486.850	60.34	1.78	74.0	-13.66	Peak	36.00	150	Horizontal	Pass
1**	2486.850	51.36	1.78	54.0	-2.64	AV	36.00	150	Horizontal	Pass
2	2483.500	58.96	1.98	74.0	-15.04	Peak	88.00	150	Horizontal	Pass
2**	2483.500	51.23	1.98	54.0	-2.77	AV	88.00	150	Horizontal	Pass

802.11g LOW CHANNEL

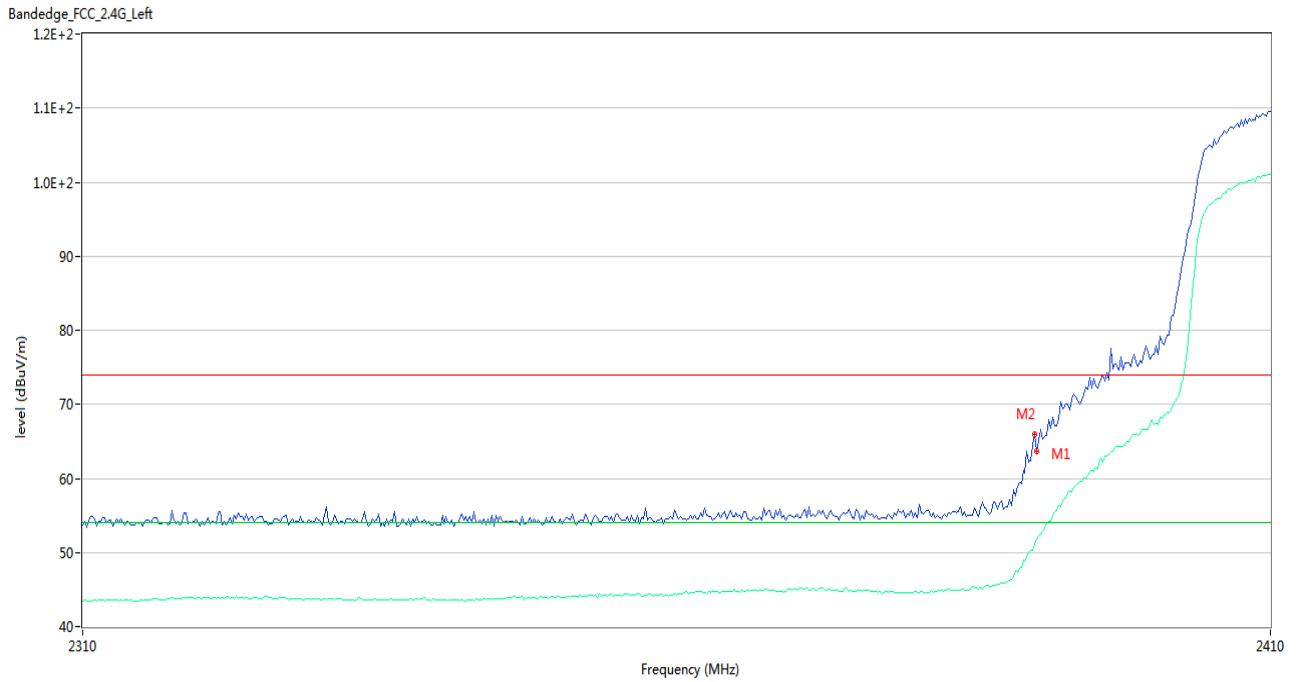

No.	Frequency (MHz)	Results (dBuV/m)	Factor (dB)	Limit (dBuV/m)	Over Limit (dB)	Detector	Table (Degree)	Height (cm)	Antenna	Verdict
1	2390.000	63.72	-0.50	74.0	-10.28	Peak	237.00	150	Horizontal	Pass
1**	2390.000	51.78	-0.50	54.0	-2.22	AV	237.00	150	Horizontal	Pass
2	2389.833	65.88	-0.50	74.0	-8.12	Peak	192.00	150	Horizontal	Pass
2**	2389.833	51.12	-0.50	54.0	-2.88	AV	192.00	150	Horizontal	Pass

802.11g HIGH CHANNEL

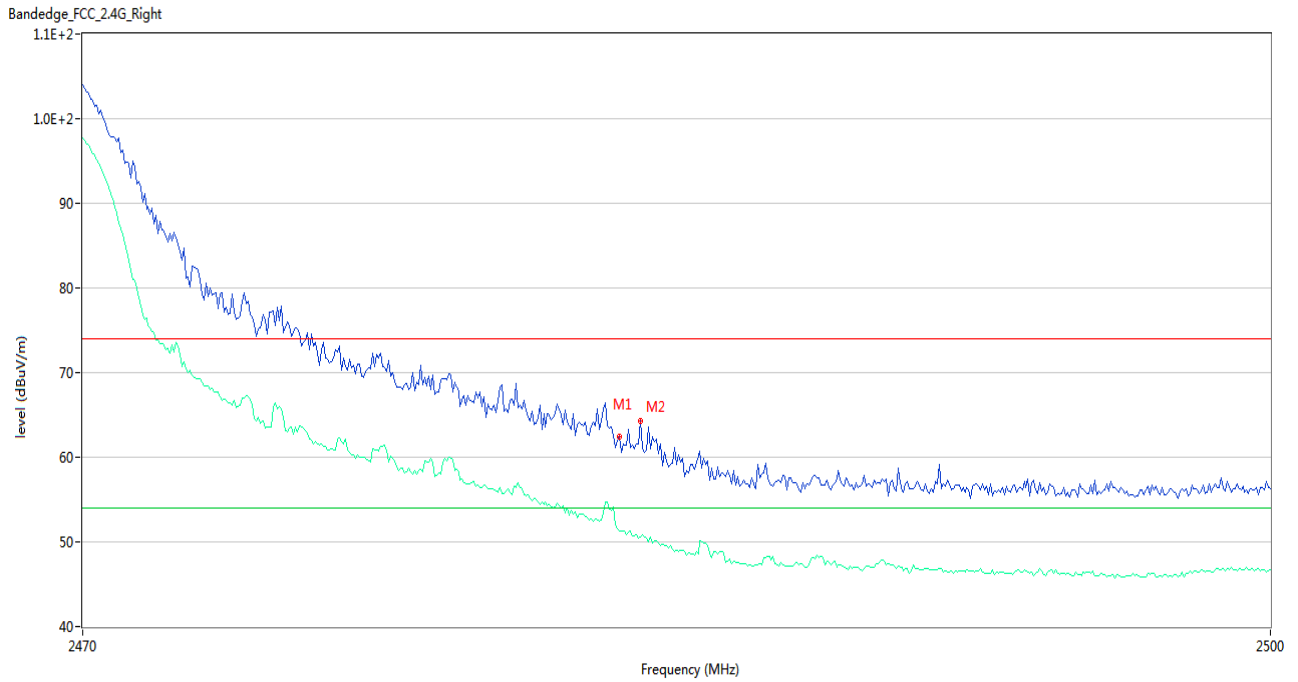

No.	Frequency (MHz)	Results (dBuV/m)	Factor (dB)	Limit (dBuV/m)	Over Limit (dB)	Detector	Table (Degree)	Height (cm)	Antenna	Verdict
1	2483.500	62.46	-0.36	74.0	-11.54	Peak	180.00	150	Horizontal	Pass
1**	2483.500	51.25	-0.36	54.0	-2.75	AV	180.00	150	Horizontal	Pass
2	2484.050	64.35	-0.34	74.0	-9.65	Peak	180.00	150	Horizontal	Pass
2**	2484.050	50.63	-0.34	54.0	-3.37	AV	180.00	150	Horizontal	Pass

802.11n20 LOW CHANNEL

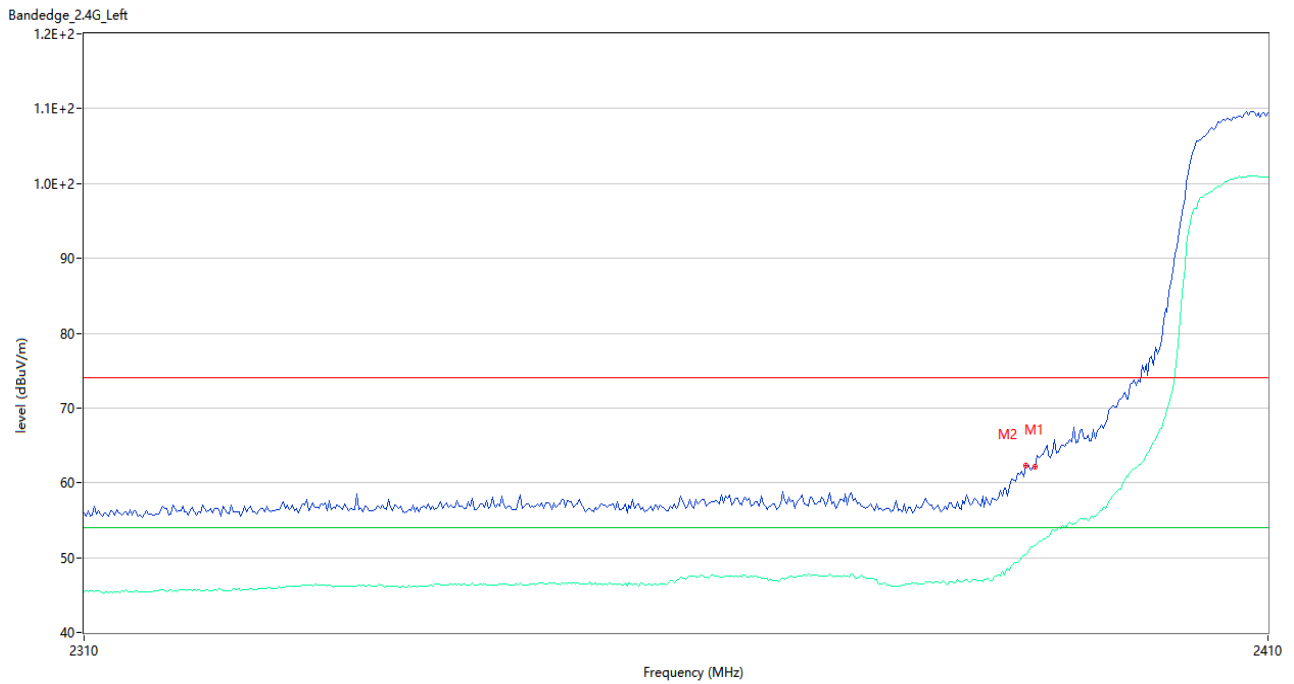

No.	Frequency (MHz)	Results (dBuV/m)	Factor (dB)	Limit (dBuV/m)	Over Limit (dB)	Detector	Table (Degree)	Height (cm)	Antenna	Verdict
1	2390.000	62.09	1.62	74.0	-11.91	Peak	345.00	150	Horizontal	Pass
1**	2390.000	51.63	1.62	54.0	-2.37	AV	345.00	150	Horizontal	Pass
2	2389.167	62.23	1.69	74.0	-11.77	Peak	322.00	150	Horizontal	Pass
2**	2389.167	50.36	1.69	54.0	-3.64	AV	322.00	150	Horizontal	Pass

802.11n20 HIGH CHANNEL

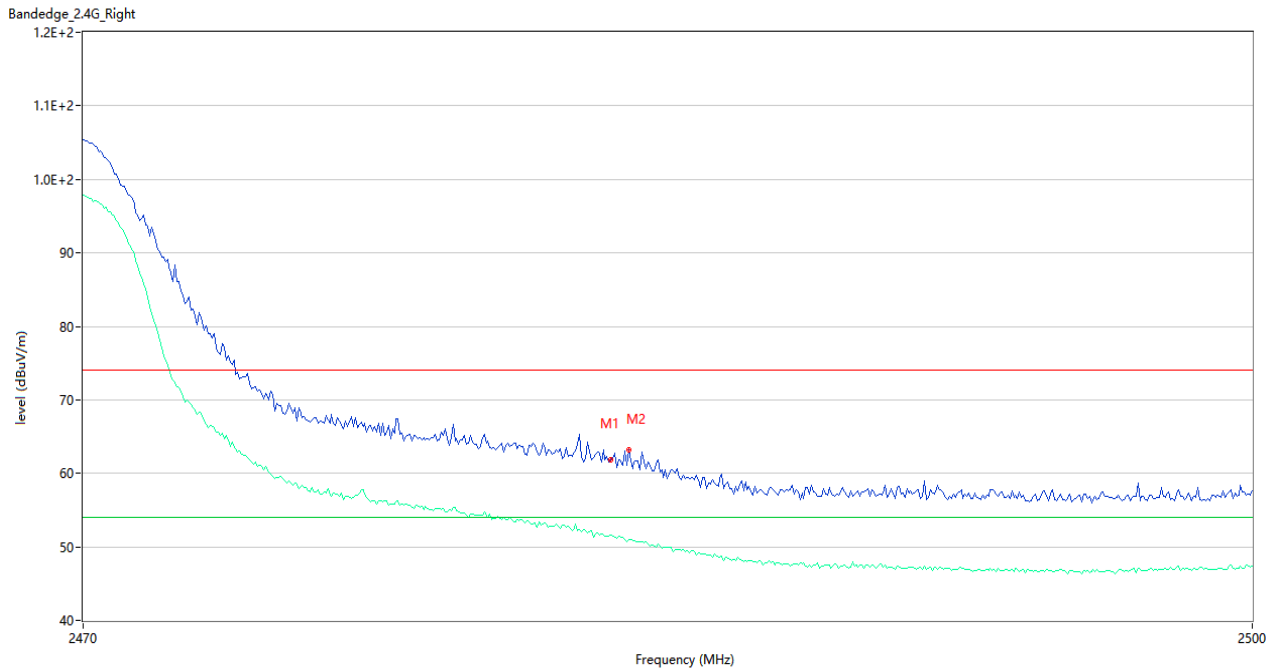

No.	Frequency (MHz)	Results (dBuV/m)	Factor (dB)	Limit (dBuV/m)	Over Limit (dB)	Detector	Table (Degree)	Height (cm)	Antenna	Verdict
1	2483.500	61.85	1.98	74.0	-12.15	Peak	89.00	150	Horizontal	Pass
1**	2483.500	51.63	1.98	54.0	-2.37	AV	89.00	150	Horizontal	Pass
2	2483.950	63.21	1.99	74.0	-10.79	Peak	89.00	150	Horizontal	Pass
2**	2483.950	50.93	1.99	54.0	-3.07	AV	89.00	150	Horizontal	Pass

802.11n40 LOW CHANNEL

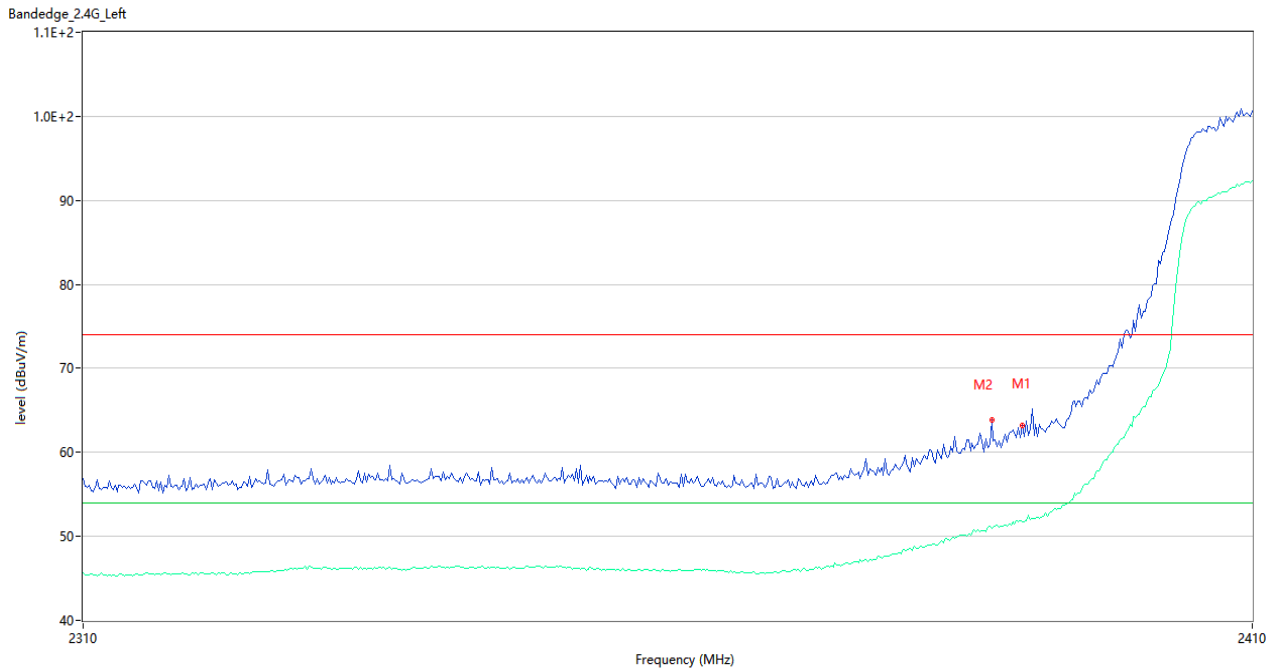

No.	Frequency (MHz)	Results (dBuV/m)	Factor (dB)	Limit (dBuV/m)	Over Limit (dB)	Detector	Table (Degree)	Height (cm)	Antenna	Verdict
1	2390.000	63.17	1.62	74.0	-10.83	Peak	352.00	150	Horizontal	Pass
1**	2390.000	51.77	1.62	54.0	-2.23	AV	352.00	150	Horizontal	Pass
2	2387.333	63.82	1.79	74.0	-10.18	Peak	354.00	150	Horizontal	Pass
2**	2387.333	50.88	1.79	54.0	-3.12	AV	354.00	150	Horizontal	Pass

802.11n40 HIGH CHANNEL

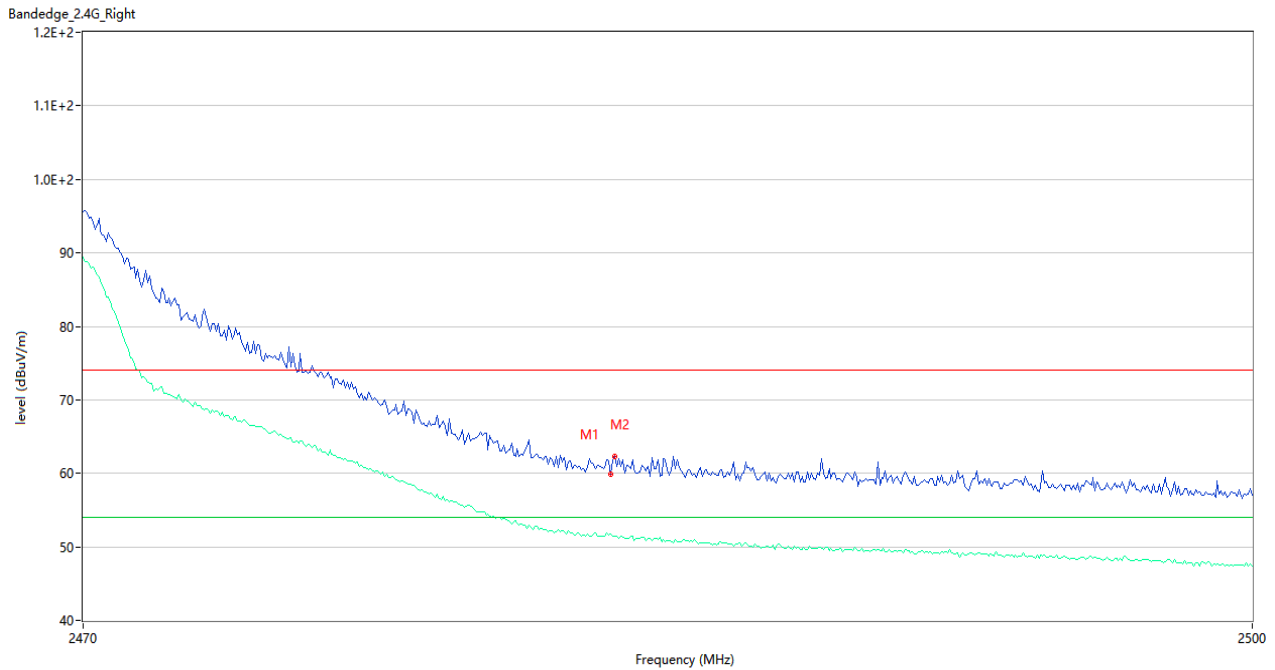

No.	Frequency (MHz)	Results (dBuV/m)	Factor (dB)	Limit (dBuV/m)	Over Limit (dB)	Detector	Table (Degree)	Height (cm)	Antenna	Verdict
1	2483.500	59.83	1.98	74.0	-14.17	Peak	11.00	150	Horizontal	Pass
1**	2483.500	51.79	1.98	54.0	-2.21	AV	11.00	150	Horizontal	Pass
2	2483.600	62.25	1.99	74.0	-11.75	Peak	8.00	150	Horizontal	Pass
2**	2483.600	51.44	1.99	54.0	-2.56	AV	8.00	150	Horizontal	Pass

MIMO

802.11n20 LOW CHANNEL

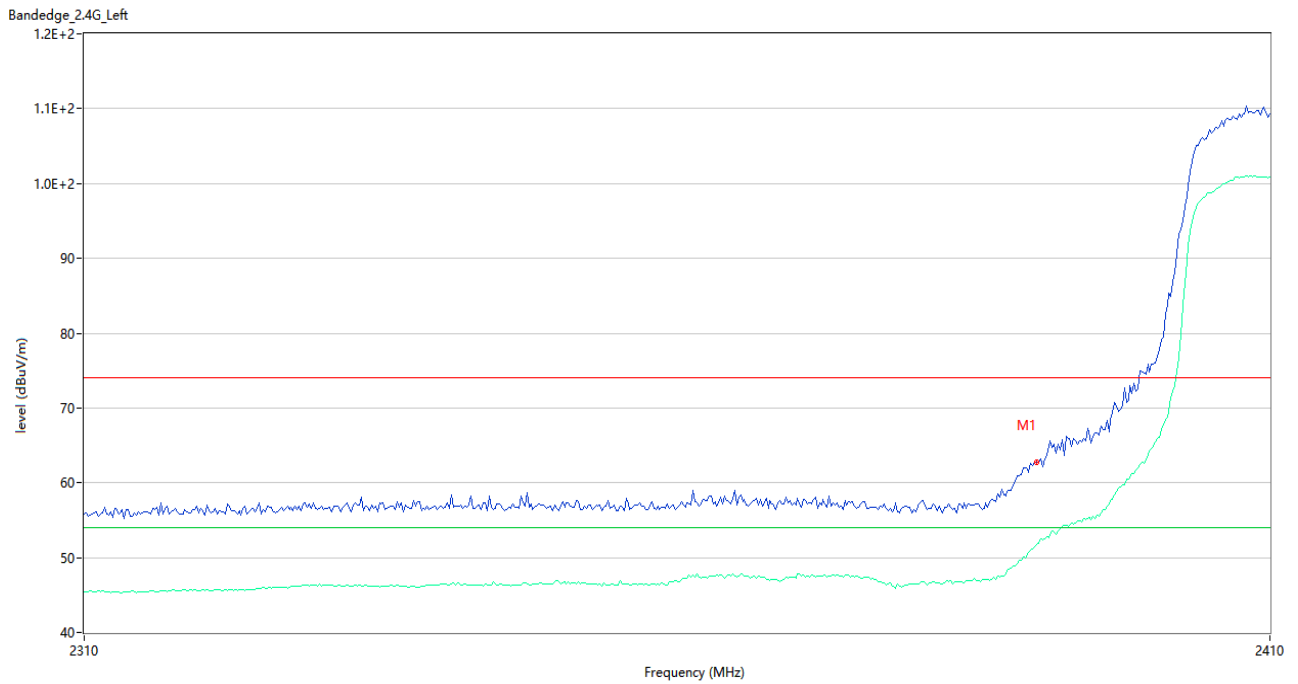

No.	Frequency (MHz)	Results (dBuV/m)	Factor (dB)	Limit (dBuV/m)	Over Limit (dB)	Detector	Table (Degree)	Height (cm)	Antenna	Verdict
1	2390.000	62.76	1.62	74.0	-11.24	Peak	328.00	150	Horizontal	Pass
1**	2390.000	51.72	1.62	54.0	-2.28	AV	328.00	150	Horizontal	Pass

802.11n20 HIGH CHANNEL

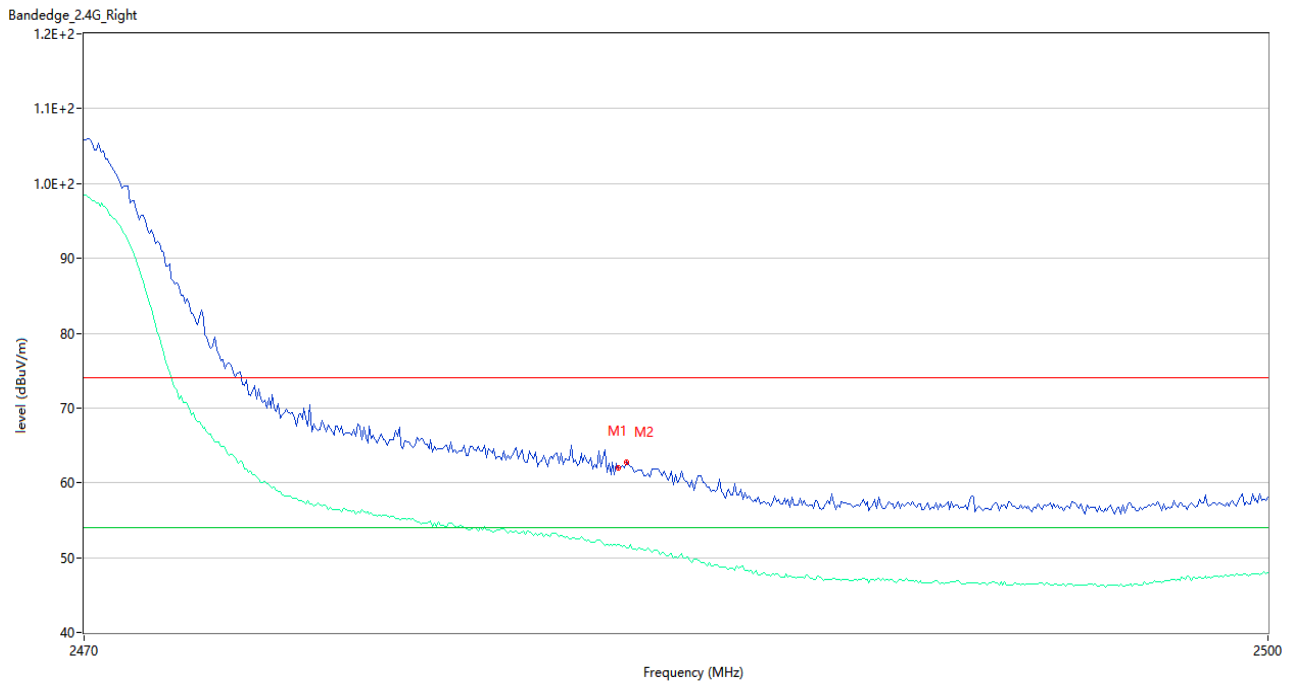

No.	Frequency (MHz)	Results (dBuV/m)	Factor (dB)	Limit (dBuV/m)	Over Limit (dB)	Detector	Table (Degree)	Height (cm)	Antenna	Verdict
1	2483.500	61.95	1.98	74.0	-12.05	Peak	100.00	150	Horizontal	Pass
1**	2483.500	51.72	1.98	54.0	-2.28	AV	100.00	150	Horizontal	Pass
2	2483.700	62.68	1.99	74.0	-11.32	Peak	98.00	150	Horizontal	Pass
2**	2483.700	51.34	1.99	54.0	-2.66	AV	98.00	150	Horizontal	Pass

802.11n40 LOW CHANNEL

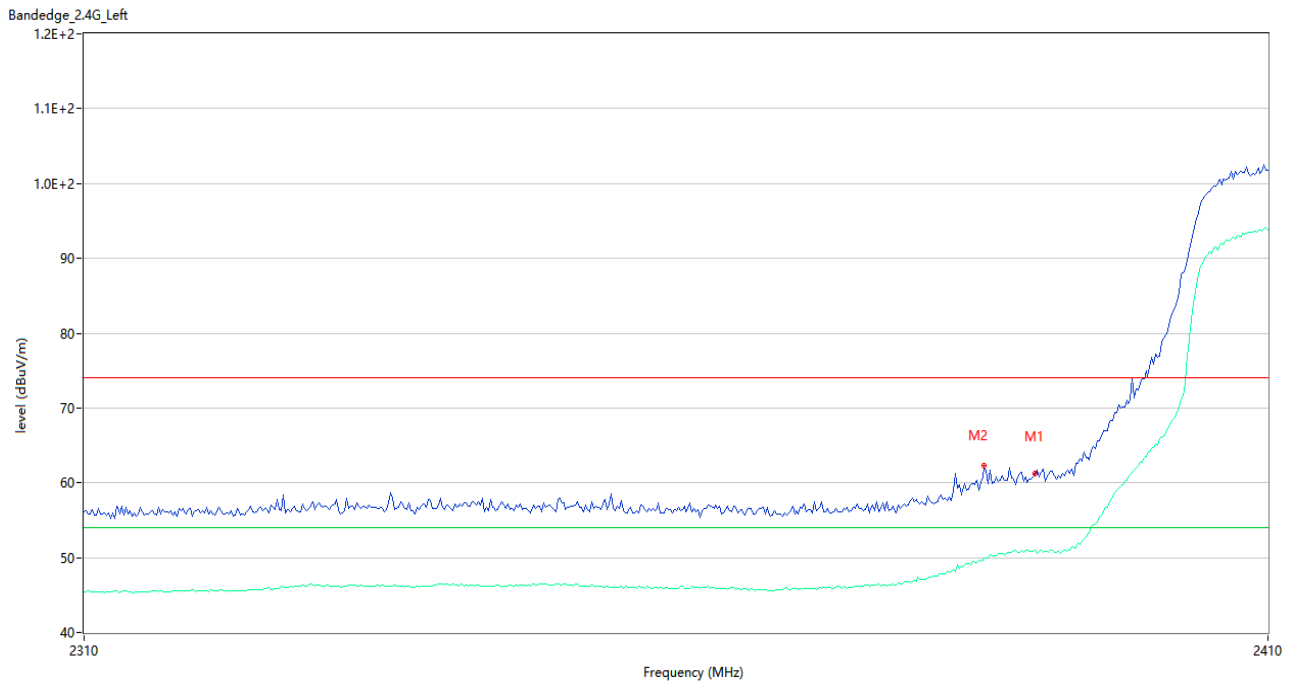

No.	Frequency (MHz)	Results (dBuV/m)	Factor (dB)	Limit (dBuV/m)	Over Limit (dB)	Detector	Table (Degree)	Height (cm)	Antenna	Verdict
1	2390.000	61.20	1.62	74.0	-12.80	Peak	317.00	150	Horizontal	Pass
1**	2390.000	51.00	1.62	54.0	-3.00	AV	317.00	150	Horizontal	Pass
2	2385.667	62.32	1.84	74.0	-11.68	Peak	7.00	150	Horizontal	Pass
2**	2385.667	49.96	1.84	54.0	-4.04	AV	7.00	150	Horizontal	Pass

802.11n40 HIGH CHANNEL

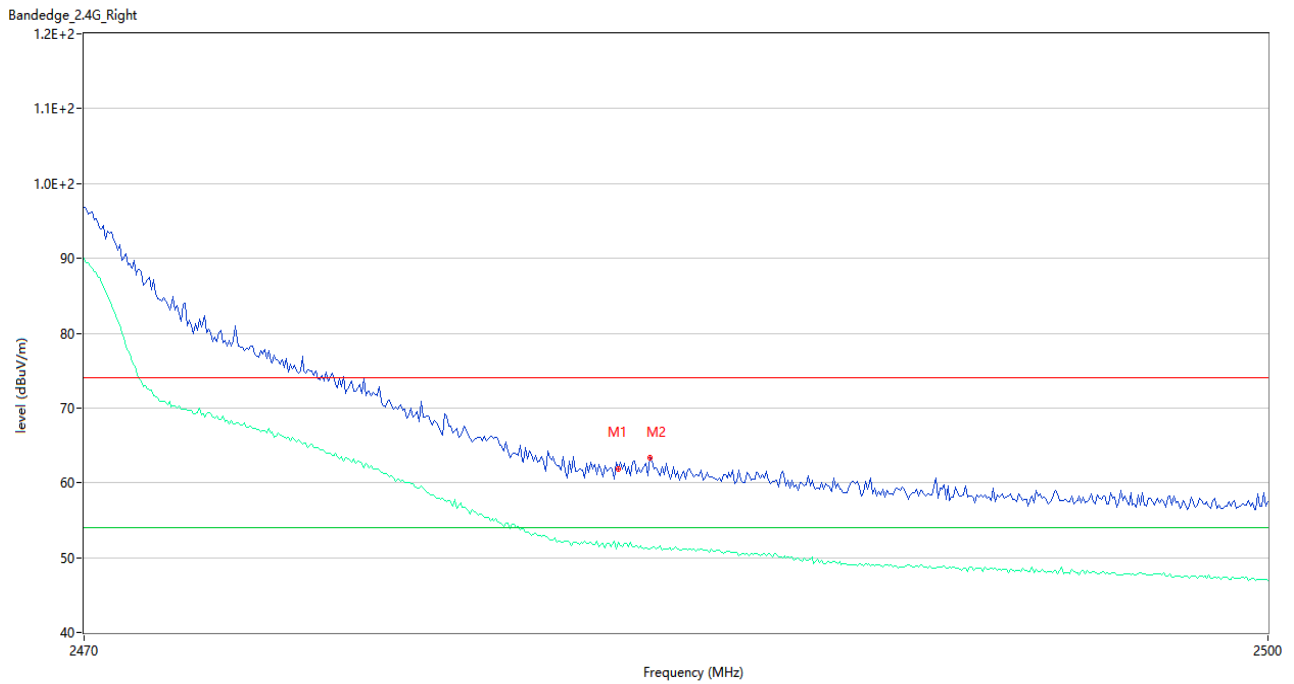

No.	Frequency (MHz)	Results (dBuV/m)	Factor (dB)	Limit (dBuV/m)	Over Limit (dB)	Detector	Table (Degree)	Height (cm)	Antenna	Verdict
1	2483.500	61.80	1.98	74.0	-12.20	Peak	6.00	150	Horizontal	Pass
1**	2483.500	51.99	1.98	54.0	-2.01	AV	6.00	150	Horizontal	Pass
2	2484.300	63.38	1.99	74.0	-10.62	Peak	13.00	150	Horizontal	Pass
2**	2484.300	51.15	1.99	54.0	-2.85	AV	13.00	150	Horizontal	Pass

A.8 Power Spectral Density (PSD)

Test Data

Main Antenna

802.11b Mode:

Channel	Spectral power density (dBm/3kHz)	Limit (dBm/3kHz)
Low	-20.72	8
Middle	-19.73	8
High	-20.74	8

802.11g Mode:

Channel	Spectral power density (dBm/3kHz)	Limit (dBm/3kHz)
Low	-21.70	8
Middle	-16.54	8
High	-20.75	8

802.11n-20 MHz Mode:

Channel	Spectral power density (dBm/3kHz)	Limit (dBm/3kHz)
Low	-22.97	8
Middle	-16.96	8
High	-22.30	8

802.11n-40 MHz Mode:

Channel	Spectral power density (dBm/3kHz)	Limit (dBm/3kHz)
Low	-28.33	8
Middle	-20.05	8
High	-30.02	8

Aux. Antenna

802.11b Mode:

Channel	Spectral power density (dBm/3kHz)	Limit (dBm/3kHz)
Low	-19.92	8
Middle	-18.56	8
High	-19.27	8

802.11g Mode:

Channel	Spectral power density (dBm/3kHz)	Limit (dBm/3kHz)
Low	-21.09	8
Middle	-16.29	8
High	-19.31	8

802.11n-20 MHz Mode:

Channel	Spectral power density (dBm/3kHz)	Limit (dBm/3kHz)
Low	-21.92	8
Middle	-16.59	8
High	-21.10	8

802.11n-40 MHz Mode:

Channel	Spectral power density (dBm/3kHz)	Limit (dBm/3kHz)
Low	-26.99	8
Middle	-19.35	8
High	-28.39	8

MIMO-Main Antenna

802.11n-20 MHz Mode:

Channel	Spectral power density (dBm/3kHz)	Limit (dBm/3kHz)
Low	-23.13	8
Middle	-17.13	8
High	-24.11	8

802.11n-40 MHz Mode:

Channel	Spectral power density (dBm/3kHz)	Limit (dBm/3kHz)
Low	-29.66	8
Middle	-19.99	8
High	-29.65	8

MIMO-Aux. Antenna

802.11n-20 MHz Mode:

Channel	Spectral power density (dBm/3kHz)	Limit (dBm/3kHz)
Low	-22.26	8
Middle	-16.49	8
High	-22.38	8

802.11n-40 MHz Mode:

Channel	Spectral power density (dBm/3kHz)	Limit (dBm/3kHz)
Low	-28.21	8
Middle	-19.06	8
High	-28.88	8

MIMO

802.11n-20 MHz Mode:

Channel	Spectral power density (dBm/3kHz)	Limit (dBm/3kHz)
Low	-19.66	8
Middle	-13.79	8
High	-20.15	8

802.11n-40 MHz Mode:

Channel	Spectral power density (dBm/3kHz)	Limit (dBm/3kHz)
Low	-25.86	8
Middle	-16.49	8
High	-26.24	8

Test Plots

Main Antenna

802.11b LOW CHANNEL



Date: 6 APR 2022 14:20:27

802.11b MIDDLE CHANNEL



Date: 6 APR 2022 14:31:47

802.11b HIGH CHANNEL



Date: 6 APR 2022 14:38:46

802.11g LOW CHANNEL



Date: 6 APR 2022 14:43:15

802.11g MIDDLE CHANNEL

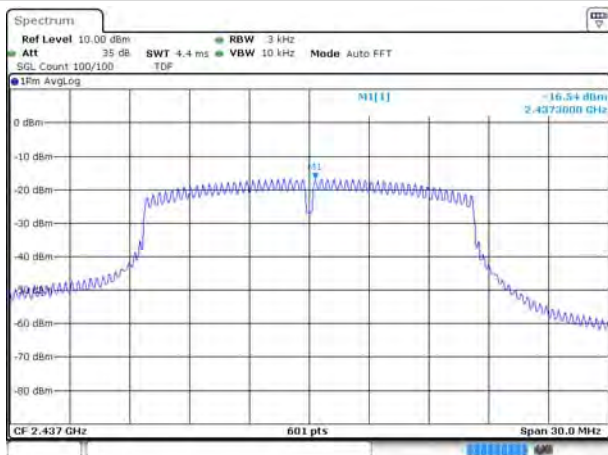

Date: 6 APR 2022 14:50:35

802.11g HIGH CHANNEL



Date: 6 APR 2022 14:54:00

802.11n-20 MHz LOW CHANNEL

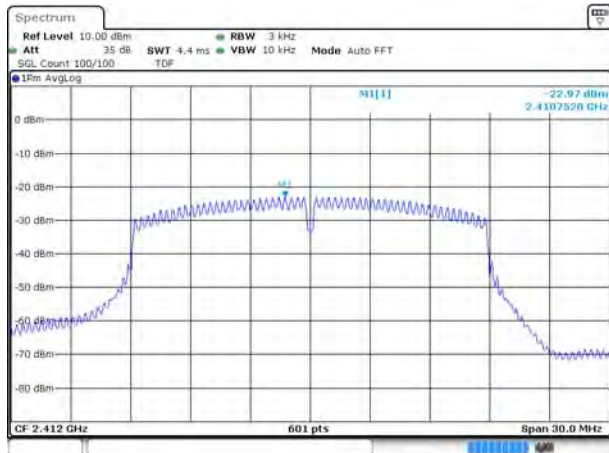

Date: 6 APR 2022 15:02:19

802.11 n-20 MHz MIDDLE CHANNEL

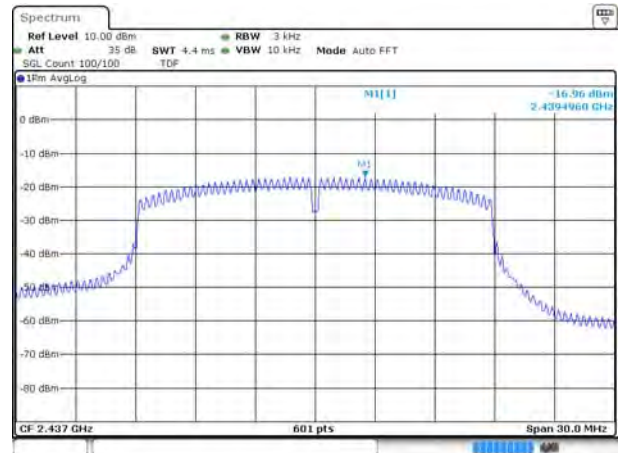

Date: 6 APR 2022 15:04:49

802.11n-20 MHz HIGH CHANNEL

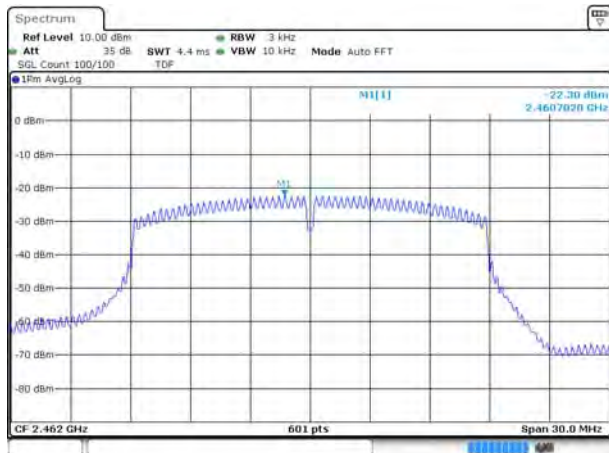

Date: 6 APR 2022 15:08:24

802.11n-40 MHz LOW CHANNEL



Date: 6 APR 2022 15:13:17

802.11n-40 MHz MIDDLE CHANNEL

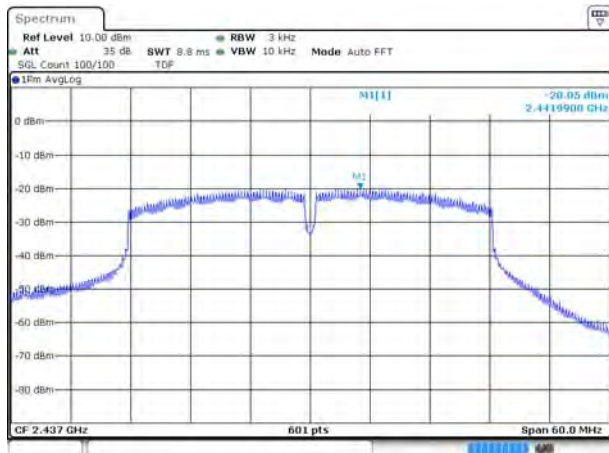

Date: 6 APR 2022 15:19:49

802.11n-40 MHz HIGH CHANNEL

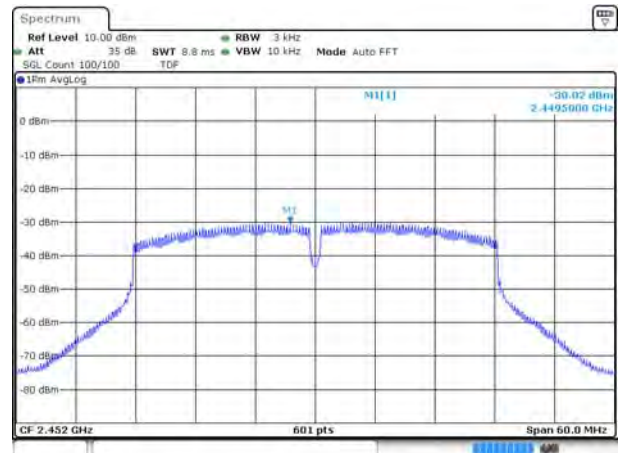

Date: 6 APR 2022 15:23:16

Aux. Antenna

802.11b LOW CHANNEL



802.11b MIDDLE CHANNEL



802.11b HIGH CHANNEL



802.11g LOW CHANNEL

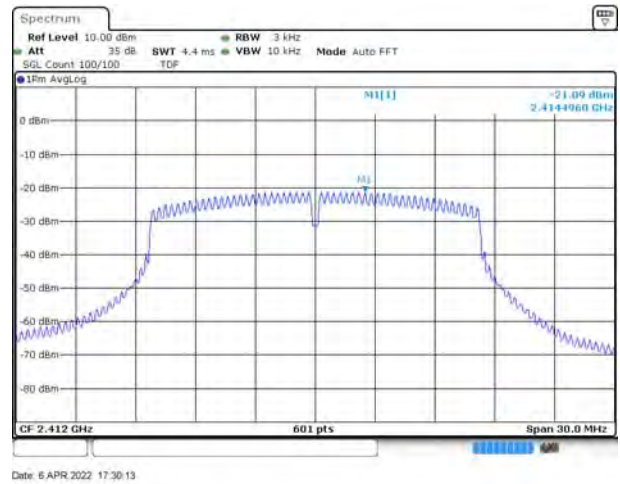

802.11g MIDDLE CHANNEL

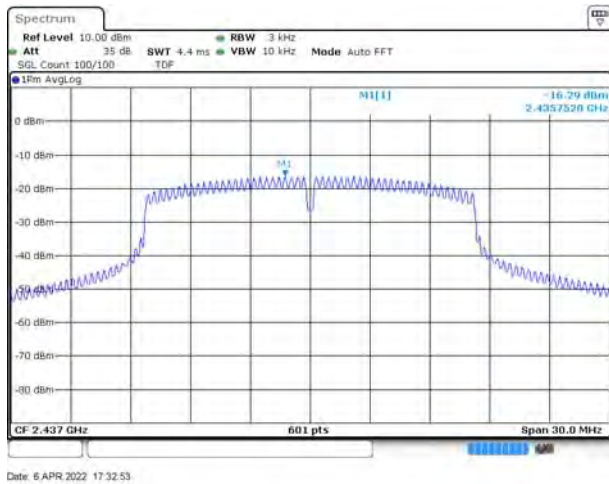

802.11g HIGH CHANNEL

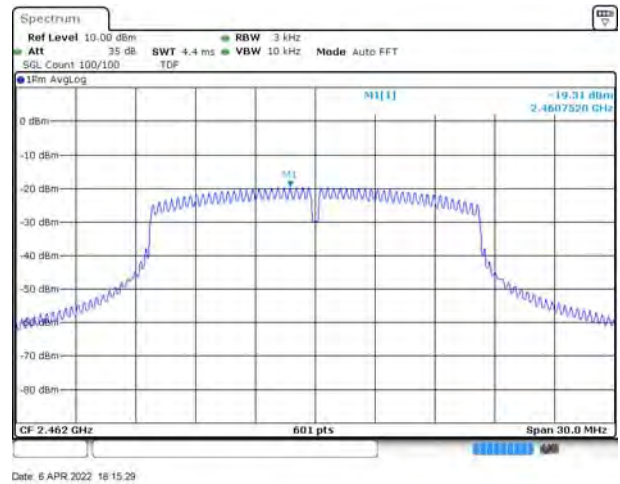

802.11n-20 MHz LOW CHANNEL

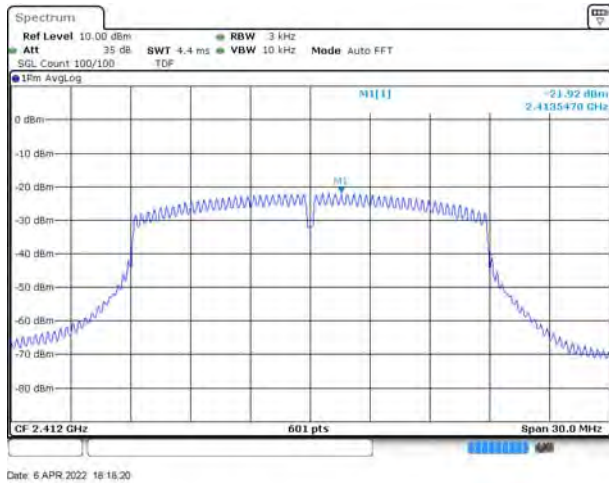

802.11 n-20 MHz MIDDLE CHANNEL

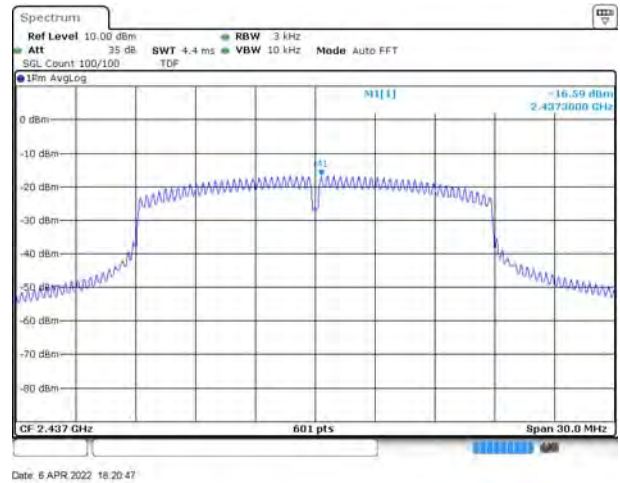

802.11n-20 MHz HIGH CHANNEL

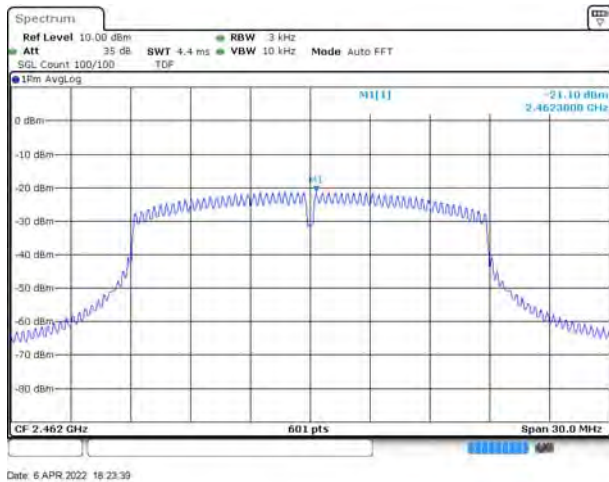

802.11n-40 MHz LOW CHANNEL

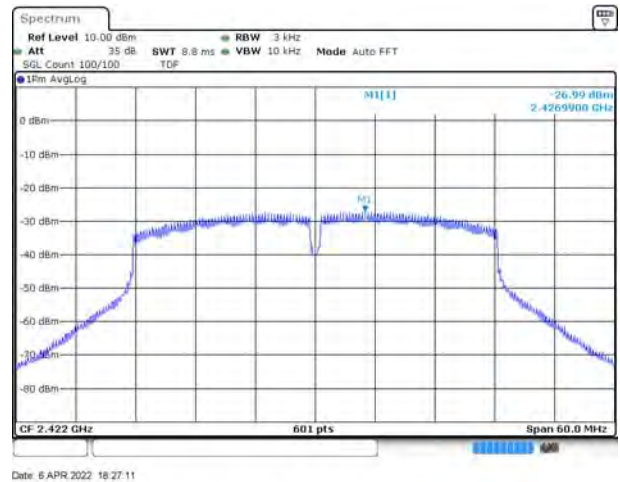

802.11n-40 MHz MIDDLE CHANNEL

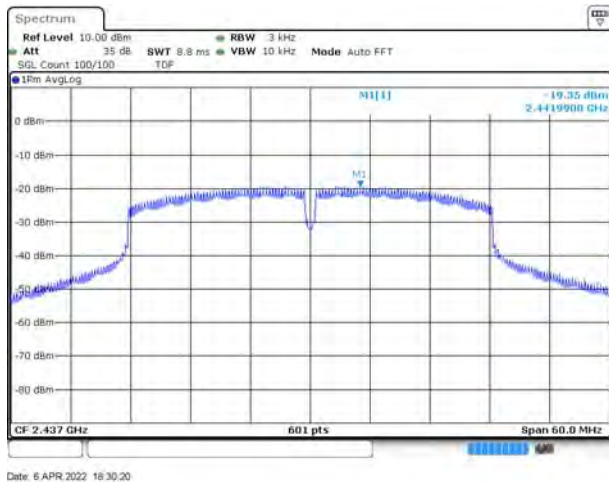

802.11n-40 MHz HIGH CHANNEL

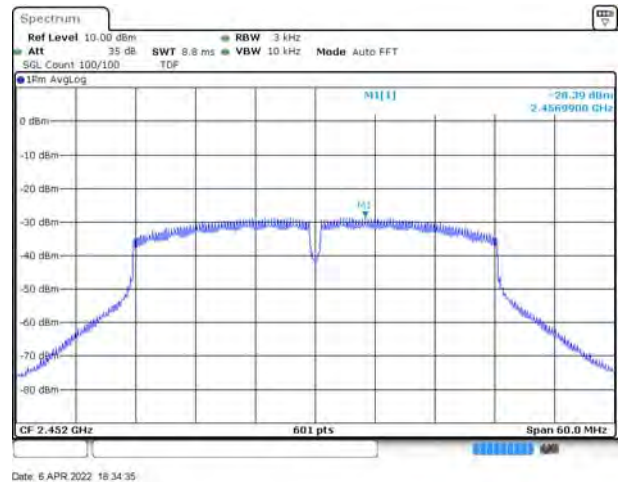

MIMO-Main Antenna

802.11n-20 MHz LOW CHANNEL

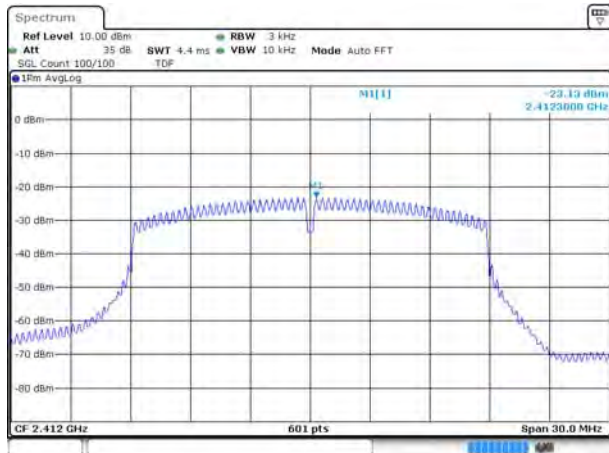

Date: 6 APR 2022 16:53:11

802.11 n-20 MHz MIDDLE CHANNEL

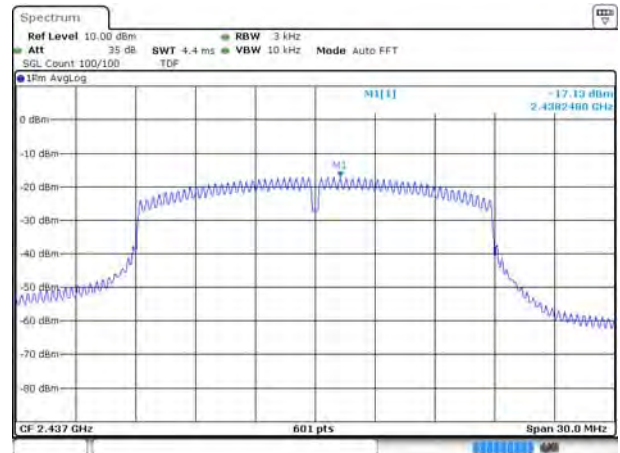

Date: 6 APR 2022 16:56:56

802.11n-20 MHz HIGH CHANNEL

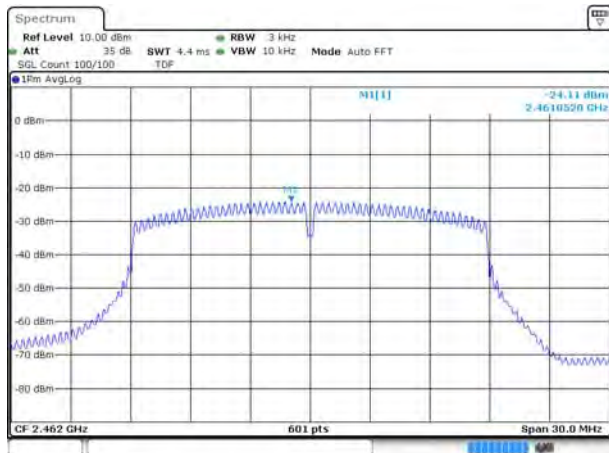

Date: 6 APR 2022 17:00:07

802.11n-40 MHz LOW CHANNEL

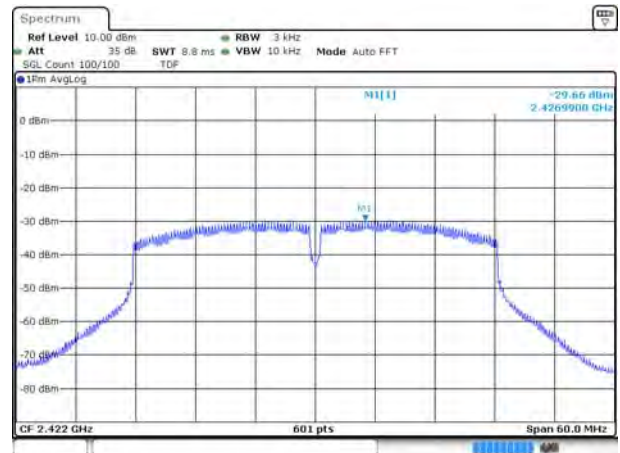

Date: 6 APR 2022 17:03:00

802.11n-40 MHz MIDDLE CHANNEL

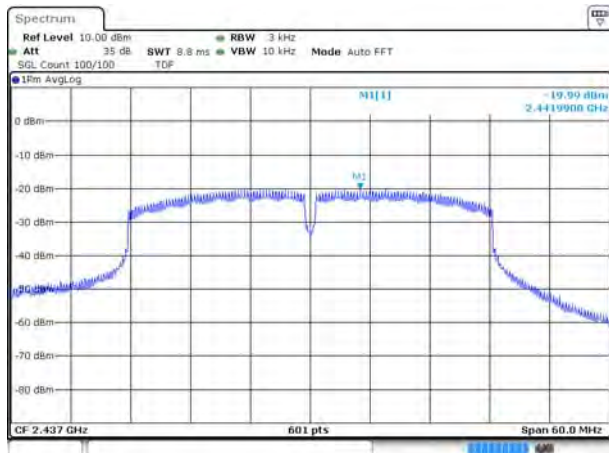

Date: 6 APR 2022 17:05:51

802.11n-40 MHz HIGH CHANNEL

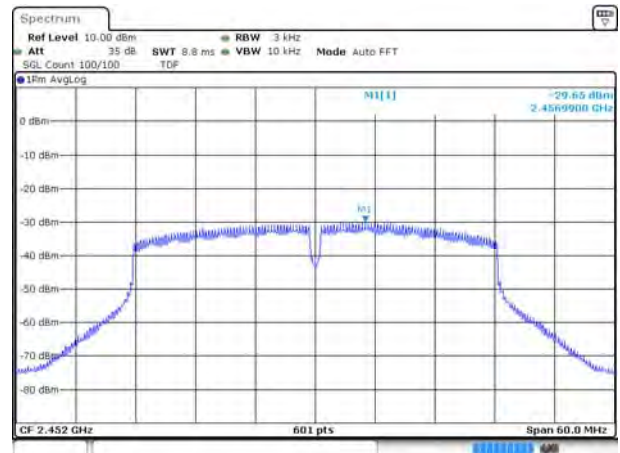

Date: 6 APR 2022 17:08:45

MIMO-Aux. Antenna

802.11n-20 MHz LOW CHANNEL

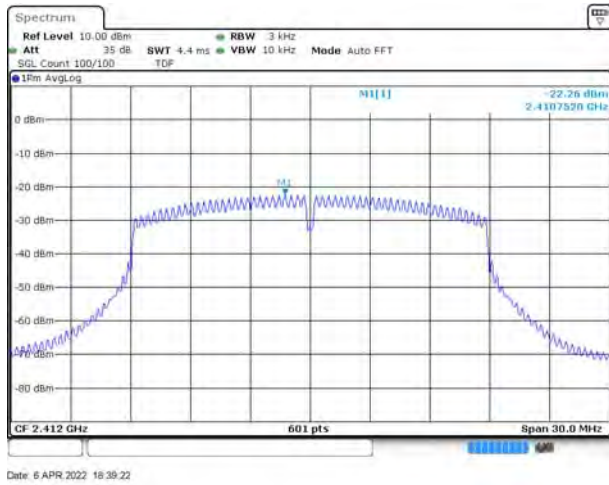

802.11 n-20 MHz MIDDLE CHANNEL

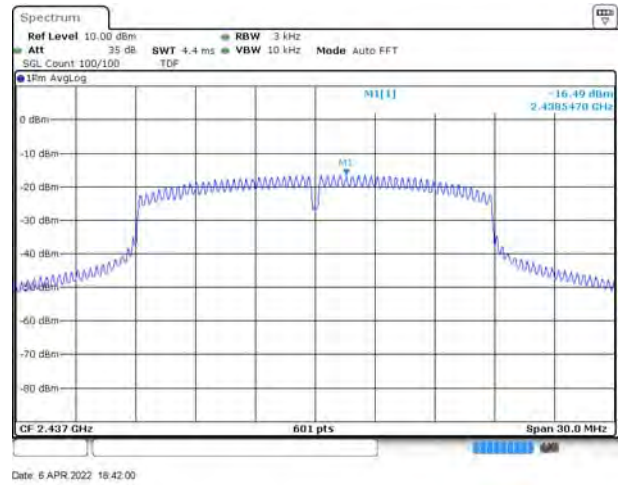

802.11n-20 MHz HIGH CHANNEL

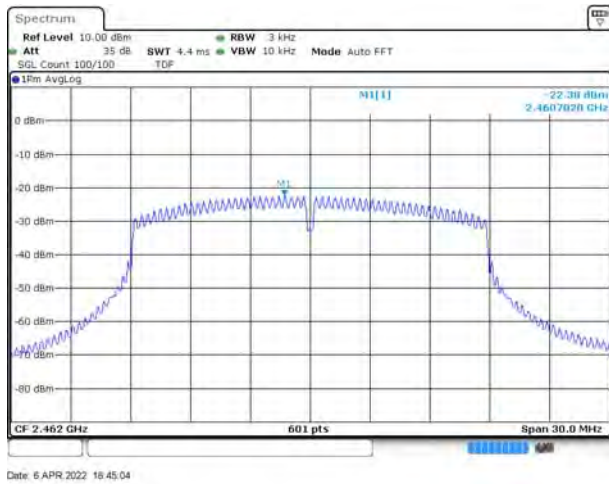

802.11n-40 MHz LOW CHANNEL

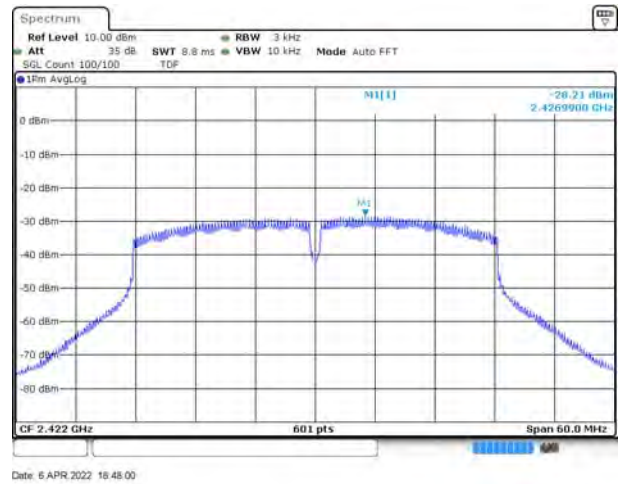

802.11n-40 MHz MIDDLE CHANNEL

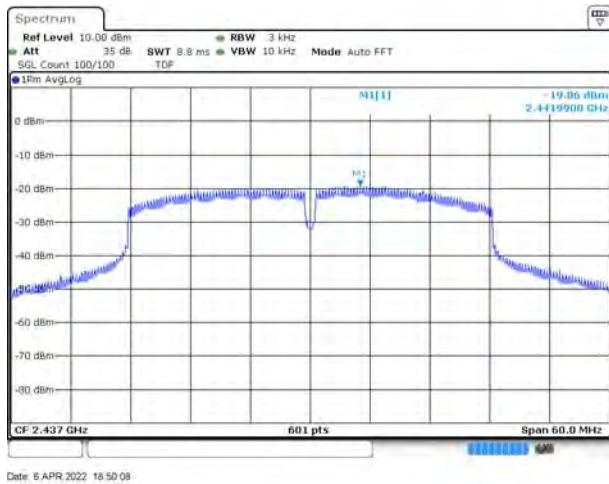

802.11n-40 MHz HIGH CHANNEL

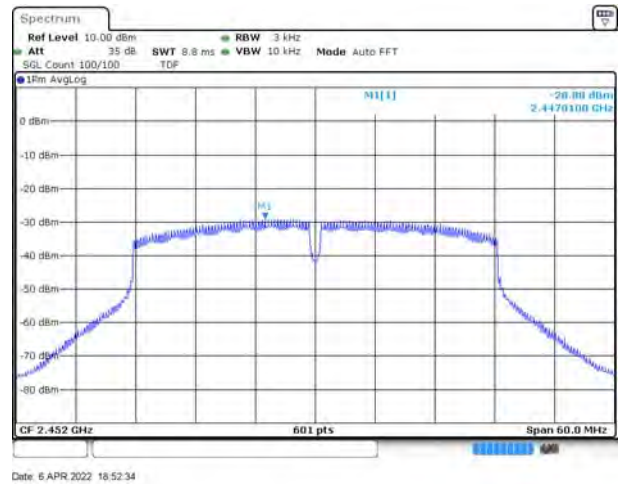

ANNEX B TEST SETUP PHOTOS

Please refer the document “BL-SZ2230807-AR.PDF”.

ANNEX C EUT EXTERNAL PHOTOS

Please refer the document “BL-SZ2230807-AW.PDF”.

ANNEX D EUT INTERNAL PHOTOS

Please refer the document “BL-SZ2230807-AI.PDF”.

Statement

1. The laboratory guarantees the scientificity, accuracy and impartiality of the test, and is responsible for all the information in the report, except the information provided by the customer. The customer is responsible for the impact of the information provided on the validity of the results.
2. The report without China inspection body and laboratory Mandatory Approval (CMA) mark has no effect of proving to the society.
3. For the report with CNAS mark or A2LA mark, the items marked with "☆" are not within the accredited scope.
4. This report is invalid if it is altered, without the signature of the testing and approval personnel, or without the "inspection and testing dedicated stamp" or test report stamp.
5. The test data and results are only valid for the tested samples provided by the customer.
6. This report shall not be partially reproduced without the written permission of the laboratory.
7. Any objection shall be raised to the laboratory within 30 days after receiving the report.

--END OF REPORT--