



Shenzhen CTA Testing Technology Co., Ltd.

Room 106, Building 1, Yibaolai Industrial Park, Qiaotou Community, Fuhai Street, Bao'an District, Shenzhen, China

FCC PART 15 SUBPART C TEST REPORT

FCC PART 15.231

Report Reference No.....: CTA22022200101

FCC ID.....: 2A5HD-BQ01

Compiled by

(position+printed name+signature)..: File administrators Kevin Liu

Supervised by

(position+printed name+signature)..: Project Engineer Kevin Liu

Approved by

(position+printed name+signature)..: RF Manager Eric Wang

Date of issue.....: Mar. 03, 2022

Testing Laboratory Name: Shenzhen CTA Testing Technology Co., Ltd.

Address.....: Room 106, Building 1, Yibaolai Industrial Park, Qiaotou Community, Fuhai Street, Bao'an District, Shenzhen, China

Applicant's name.....: Shenzhen Hongkang International Electronic Technology Co., Ltd.

Address: Room 202, Building 7, Zhenbao Industrial Zone, Jinglong Community, Longhua Street, Longhua District, Shenzhen

Test specification

Standard.....: FCC Part 15.231

Shenzhen CTA Testing Technology Co., Ltd. All rights reserved.

This publication may be reproduced in whole or in part for non-commercial purposes as long as the Shenzhen CTA Testing Technology Co., Ltd. is acknowledged as copyright owner and source of the material. Shenzhen CTA Testing Technology Co., Ltd. takes no responsibility for and will not assume liability for damages resulting from the reader's interpretation of the reproduced material due to its placement and context.

Test item description: **Wireless meat thermometer**

Trade Mark: N/A

Manufacturer: Shenzhen Hongkang International Electronic Technology Co., Ltd.

Model/Type reference.....: BQ01

Listed Models: BQ02, BQ08, BQ06, BQ50, HK-50A, HK-50B, HK-80A, HK-80B, HK-05A, HK-05B, HK-BQ01, HK-BQ02, HK-W01, HK-W02

Ratings: DC 3.3V From Battery

Modulation: ASK

Frequency.....: 433.8855MHz

Result.....: **PASS**



TEST REPORT

Equipment under Test : Wireless meat thermometer
Model /Type : BQ01,
Listed Models : BQ02, BQ08, BQ06, BQ50, HK-50A, HK-50B, HK-80A, HK-80B,
HK-05A, HK-05B, HK-BQ01, HK-BQ02, HK-W01, HK-W02

Model Declaration : PCB board, structure and internal of these model(s) are the same,
So no additional models were tested.

Applicant : **Shenzhen Hongkang International Electronic Technology Co., Ltd.**

Address : Room 202, Building 7, Zhenbao Industrial Zone, Jinglong Community,
Longhua Street, Longhua District, Shenzhen

Manufacturer : **Shenzhen Hongkang International Electronic Technology Co., Ltd.**

Address : Room 202, Building 7, Zhenbao Industrial Zone, Jinglong Community,
Longhua Street, Longhua District, Shenzhen

Test Result:	PASS
---------------------	-------------

The test report merely corresponds to the test sample.
It is not permitted to copy extracts of these test result without the written permission of the test laboratory.

Contents

1	<u>TEST STANDARDS</u>	4
2	<u>SUMMARY</u>	5
2.1	General Remarks	5
2.2	Product Description	5
2.3	Equipment Under Test	5
2.4	Short description of the Equipment under Test (EUT)	5
2.5	Block Diagram of Test Setup	5
2.6	Special Accessories	5
2.7	Related Submittal(s) / Grant (s)	6
2.8	Modifications	6
3	<u>TEST ENVIRONMENT</u>	7
3.1	Address of the test laboratory	7
3.2	Test Facility	7
3.3	Environmental conditions	7
3.4	Summary of measurement results	8
3.5	Statement of the measurement uncertainty	8
3.6	Equipments Used during the Test	9
4	<u>TEST CONDITIONS AND RESULTS</u>	10
4.1	AC Power Conducted Emission	10
4.2	Radiated Emission	11
4.3	20dB Bandwidth	15
4.4	Deactivation Time	16
4.5	Antenna Requirement	17
5	<u>TEST SETUP PHOTOS OF THE EUT</u>	18
6	<u>PHOTOS OF THE EUT</u>	19

1 TEST STANDARDS

The tests were performed according to following standards:

[FCC Rules Part 15.231](#): Periodic operation in the band 40.66-40.70 MHz and above 70 MHz.

[ANSI C63.10:2013](#) : American National Standard for Testing Unlicensed Wireless Devices

2 SUMMARY

2.1 General Remarks

Date of receipt of test sample	:	Feb. 20, 2022
Testing commenced on	:	Feb. 20, 2022
Testing concluded on	:	Mar. 03, 2022

2.2 Product Description

Product Name:	Wireless meat thermometer
Model/Type reference:	BQ01
Testing sample ID:	CTA220222001-1# (Engineer sample), CTA220222001-2#(Normal sample)
Power supply:	DC 3.3V From Battery
Modulation:	ASK
Operation frequency:	433.8855MHz
Channel number:	1
Antenna type:	Internal antenna
Antenna gain:	0 dBi

2.3 Equipment Under Test

Power supply system utilised

Power supply voltage	:	<input type="radio"/> 230V / 50 Hz	<input type="radio"/> 120V / 60Hz
		<input type="radio"/> 12 V DC	<input type="radio"/> 24 V DC
		<input checked="" type="radio"/> Other (specified in blank below)	

DC 3.3V From Battery

2.4 Short description of the Equipment under Test (EUT)

This is a Wireless meat thermometer.

For more details, refer to the user's manual of the EUT.

2.5 Block Diagram of Test Setup

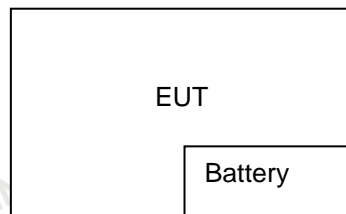

2.6 Special Accessories

Follow auxiliary equipment(s) test with EUT that provided by the manufacturer or laboratory is listed as follow:

Description	Manufacturer	Model	Technical Parameters	Certificate	Provided by
/	/	/	/	/	/
/	/	/	/	/	/

2.7 Related Submittal(s) / Grant (s)

This submittal(s) (test report) is intended for the device filing to comply with Section 15.231 of the FCC Part 15, Subpart C Rules.

2.8 Modifications

No modifications were implemented to meet testing criteria.

3 TEST ENVIRONMENT

3.1 Address of the test laboratory

Shenzhen CTA Testing Technology Co., Ltd.

Room 106, Building 1, Yibaolai Industrial Park, Qiaotou Community, Fuhai Street, Bao'an District, Shenzhen, China

3.2 Test Facility

The test facility is recognized, certified, or accredited by the following organizations:

FCC-Registration No.: 517856 Designation Number: CN1318

Shenzhen CTA Testing Technology Co., Ltd. has been listed on the US Federal Communications Commission list of test facilities recognized to perform electromagnetic emissions measurements.

Industry Canada Registration Number. Is: 27890 CAB identifier: CN0127

The Laboratory has been registered by Certification and Engineering Bureau of Industry Canada for radio equipment testing.

A2LA-Lab Cert. No.: 6534.01

Shenzhen CTA Testing Technology Co., Ltd. has been listed by American Association for Laboratory Accreditation to perform electromagnetic emission measurement.

The 3m-Semi anechoic test site fulfils CISPR 16-1-4 according to ANSI C63.10 and CISPR 16-1-4:2010.

3.3 Environmental conditions

During the measurement the environmental conditions were within the listed ranges:

Radiated Emission:

Temperature:	25 ° C
Humidity:	45 %
Atmospheric pressure:	950-1050mbar

Conducted testing:

Temperature:	25 ° C
Humidity:	44 %
Atmospheric pressure:	950-1050mbar

3.4 Summary of measurement results

FCC and IC Requirements		
FCC Part 15.207	Conducted Emission	N/A
FCC Part 15.231(a)(2)	Automatically Deactivate	PASS
FCC Part 15.231(b)	Electric Field Strength of Fundamental Emission	PASS
FCC Part 15.205 & 15.209 & 15.231(b)	Electric Field Strength of Spurious Emission	PASS
FCC Part 15.231(c)	-20dB bandwidth	PASS

Remark: The measurement uncertainty is not included in the test result.

3.5 Statement of the measurement uncertainty

The data and results referenced in this document are true and accurate. The reader is cautioned that there may be errors within the calibration limits of the equipment and facilities. The measurement uncertainty was calculated for all measurements listed in this test report acc. to TR-100028-01 "Electromagnetic compatibility and Radio spectrum Matters (ERM); Uncertainties in the measurement of mobile radio equipment characteristics; Part 1" and TR-100028-02 "Electromagnetic compatibility and Radio spectrum Matters (ERM); Uncertainties in the measurement of mobile radio equipment characteristics; Part 2" and is documented in the Shenzhen CTA Testing Technology Co., Ltd. quality system acc. to DIN EN ISO/IEC 17025. Furthermore, component and process variability of devices similar to that tested may result in additional deviation. The manufacturer has the sole responsibility of continued compliance of the device. Hereafter the best measurement capability for Shenzhen CTA Testing Technology Co., Ltd. :

Test	Range	Measurement Uncertainty	Notes
Radiated Emission	30~1000MHz	4.10 dB	(1)
Radiated Emission	1~18GHz	4.32 dB	(1)
Radiated Emission	18-40GHz	5.54 dB	(1)
Conducted Disturbance	0.15~30MHz	3.12 dB	(1)

- (1) This uncertainty represents an expanded uncertainty expressed at approximately the 95% confidence level using a coverage factor of k=2.

3.6 Equipments Used during the Test

Test Equipment	Manufacturer	Model No.	Equipment No.	Calibration Date	Calibration Due Date
LISN	R&S	ENV216	CTA-308	2021/08/06	2022/08/05
LISN	R&S	ENV216	CTA-314	2021/08/06	2022/08/05
EMI Test Receiver	R&S	ESPI	CTA-307	2021/08/06	2022/08/05
EMI Test Receiver	R&S	ESCI	CTA-306	2021/08/06	2022/08/05
Spectrum Analyzer	Agilent	N9020A	CTA-301	2021/08/06	2022/08/05
Spectrum Analyzer	R&S	FSP	CTA-337	2021/08/06	2022/08/05
Vector Signal generator	Agilent	N5182A	CTA-305	2021/08/06	2022/08/05
Analog Signal Generator	R&S	SML03	CTA-304	2021/08/06	2022/08/05
Universal Radio Communication	CMW500	R&S	CTA-302	2021/08/06	2022/08/05
Temperature and humidity meter	Chigo	ZG-7020	CTA-326	2021/08/06	2022/08/05
Ultra-Broadband Antenna	Schwarzbeck	VULB9163	CTA-310	2021/08/07	2022/08/06
Horn Antenna	Schwarzbeck	BBHA 9120D	CTA-309	2021/08/07	2022/08/06
Loop Antenna	Zhinan	ZN30900C	CTA-311	2021/08/07	2022/08/06
Horn Antenna	Beijing Hangwei Dayang	OBH100400	CTA-336	2021/08/06	2022/08/05
Amplifier	Schwarzbeck	BBV 9745	CTA-312	2021/08/06	2022/08/05
Amplifier	Taiwan chengyi	EMC051845B	CTA-313	2021/08/06	2022/08/05
Directional coupler	NARDA	4226-10	CTA-303	2021/08/06	2022/08/05
High-Pass Filter	XingBo	XBLBQ-GTA18	CTA-402	2021/08/06	2022/08/05
High-Pass Filter	XingBo	XBLBQ-GTA27	CTA-403	2021/08/06	2022/08/05
Automated filter bank	Tonscend	JS0806-F	CTA-404	2021/08/06	2022/08/05
Power Sensor	Agilent	U2021XA	CTA-405	2021/08/06	2022/08/05
Amplifier	Schwarzbeck	BBV9719	CTA-406	2021/08/06	2022/08/05

Note: The Cal.Interval was one year.

4 TEST CONDITIONS AND RESULTS

4.1 AC Power Conducted Emission

TEST CONFIGURATION

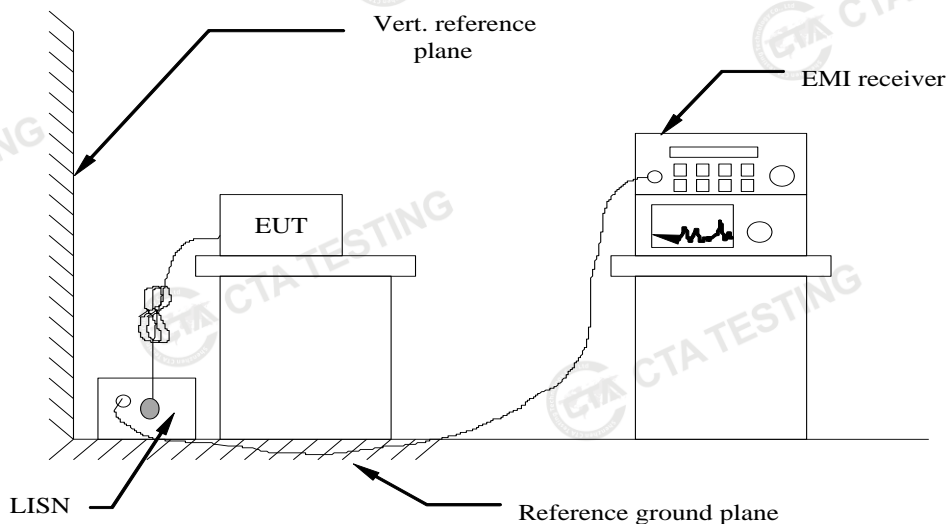

TEST PROCEDURE

- 1 The equipment was set up as per the test configuration to simulate typical actual usage per the user's manual. The EUT is a tabletop system, a wooden table with a height of 0.8 meters is used and is placed on the ground plane as per ANSI C63.10-2013.
- 2 Support equipment, if needed, was placed as per ANSI C63.10-2013
- 3 All I/O cables were positioned to simulate typical actual usage as per ANSI C63.10-2013
- 4 The EUT received DC 12V power from adapter, the adapter received AC120V/60Hz and AC 240V/60Hz power through a Line Impedance Stabilization Network (LISN) which supplied power source and was grounded to the ground plane.
- 5 All support equipments received AC power from a second LISN, if any.
- 6 The EUT test program was started. Emissions were measured on each current carrying line of the EUT using a spectrum Analyzer / Receiver connected to the LISN powering the EUT. The LISN has two monitoring points: Line 1 (Hot Side) and Line 2 (Neutral Side). Two scans were taken: one with Line 1 connected to Analyzer / Receiver and Line 2 connected to a 50 ohm load; the second scan had Line 1 connected to a 50 ohm load and Line 2 connected to the Analyzer / Receiver.
- 7 Analyzer / Receiver scanned from 150 KHz to 30MHz for emissions in each of the test modes.
- 8 During the above scans, the emissions were maximized by cable manipulation.

AC Power Conducted Emission Limit

For intentional device, according to § 15.207(a) AC Power Conducted Emission Limits is as following :

Frequency range (MHz)	Limit (dBuV)	
	Quasi-peak	Average
0.15-0.5	66 to 56*	56 to 46*
0.5-5	56	46
5-30	60	50

* Decreases with the logarithm of the frequency.

TEST RESULTS

The EUT is powered by the Battery, So this test item is not applicable for the EUT.

4.2 Radiated Emission

Limit

For intentional device, according to 15.209(a) the general requirement of field strength of radiated emission from intentional radiators at a distance of 3 meters shall not exceed the following table.

Frequency (MHz)	Distance (Meters)	Radiated (dBµV/m)	Radiated (µV/m)
0.009-0.49	3	$20\log(2400/F(KHz))+40\log(300/3)$	$2400/F(KHz)$
0.49-1.705	3	$20\log(24000/F(KHz))+ 40\log(30/3)$	$24000/F(KHz)$
1.705-30	3	$20\log(30)+ 40\log(30/3)$	30
30-88	3	40.0	100
88-216	3	43.5	150
216-960	3	46.0	200
Above 960	3	54.0	500

In addition to the provisions of 15.231(b), the field strength of emissions from intentional radiators operated under this section shall not exceed the following:

Funda-mental fre-quency (MHz)	Field strength of funda-mental (microvolts/ meter)	Field strength of spurious emissions (microvolts/meter)
40.66– 40.70.	2,250	225
70–130	1,250	125
130–174	¹ 1,250 to 3,750	¹ 125 to 375
174–260	3,750	375
260–470	¹ 3,750 to 12,500	¹ 375 to 1,250
Above 470	12,500	1,250

¹ Linear interpolations.

[Where F is the frequency in MHz, the formulas for calculating the maximum permitted fundamental field strengths are as follows: for the band 260-470 MHz, $20*\log(41.6667*433.890-7083.3333)=80.82\text{dBuV/m}$ The maximum permitted unwanted emission level is 20 dB below the maximum permitted fundamental level.]

TEST CONFIGURATION

(A) Radiated Emission Test Set-Up, Frequency Below 30MHz

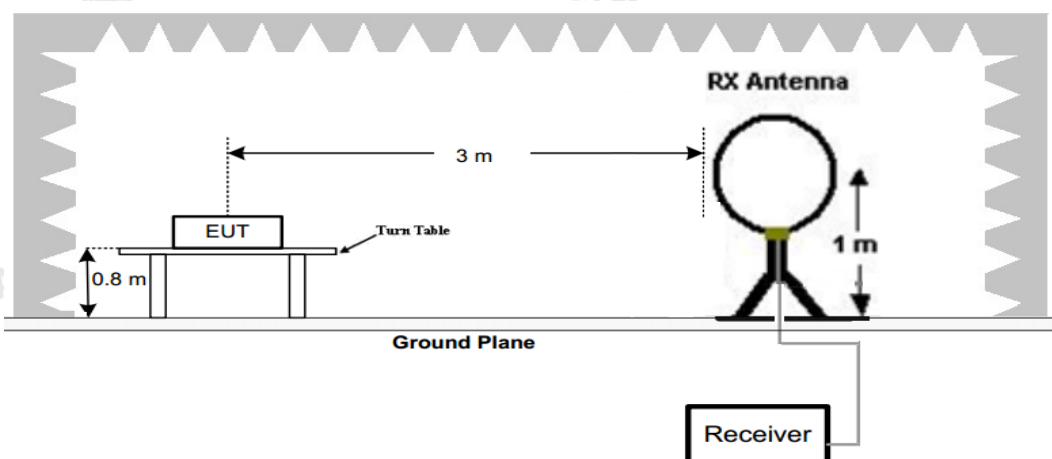

(B) Radiated Emission Test Set-Up, Frequency below 1000MHz

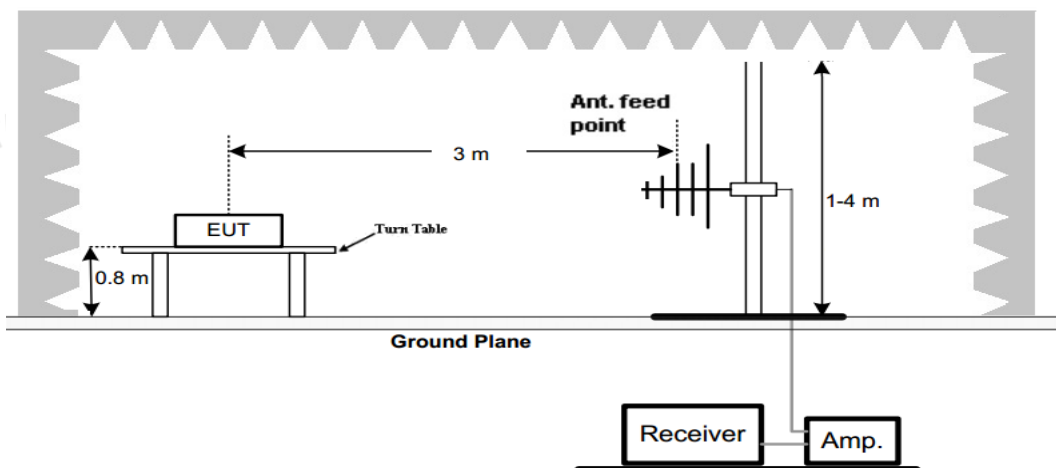

(C) Radiated Emission Test Set-Up, Frequency above 1000MHz

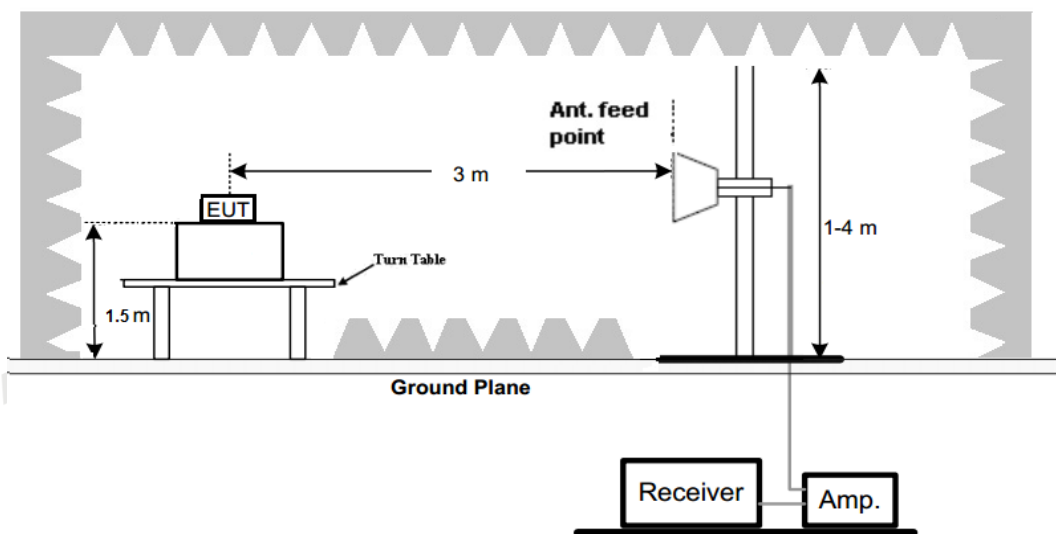

Test Procedure

1. Below 1GHz measurement the EUT is placed on a turntable which is 0.8m above ground plane, and above 1GHz measurement EUT was placed on a low permittivity and low loss tangent turn table which is 1.5m above ground plane.
2. Maximum procedure was performed by raising the receiving antenna from 1m to 4m and rotating the turn table from 0° to 360° to acquire the highest emissions from EUT
3. And also, each emission was to be maximized by changing the polarization of receiving antenna both horizontal and vertical.
4. Repeat above procedures until all frequency measurements have been completed.

TEST RESULTS

The emissions from 30MHz to 5GHz are measured peak and average level, below 1 GHz measured QP level, detailed test data please see below. Besides, we tested 3 directions and recorded the worst data.

Emission Styles	Frequency (MHz)	Reading (dBuV)	Factor (dB/m)	Level (dBuV/m)	Limit (dBuV/m)	Margin (dB)	Detector	Direction (H/V)
Fundamental	433.8855	94.04	-11.26	82.78	100.82	18.04	PK	H
Spurious	469.31	52.73	-12.41	40.32	46	5.68	PK	H
Harmonics	867.7710	72.38	-17.69	54.69	80.82	26.13	PK	H
Harmonics	1301.6565	47.04	5.29	52.33	74	21.67	PK	H
--	--	--	--	--	--	--	--	--
Fundamental	433.8855	90.49	-11.26	79.23	100.82	21.59	PK	V
Spurious	469.31	50.84	-12.41	38.43	46	7.57	PK	V
Harmonics	867.7710	71.84	-17.69	54.15	80.82	26.67	PK	V
Harmonics	1301.6565	46.90	5.29	52.19	74	21.81	PK	V
--	--	--	--	--	--	--	--	--

Emission Styles	Frequency (MHz)	PK Level (dBuV/m)	AV Factor (dB/m)	AV Level (dBuV/m)	Limit (dBuV/m)	Margin (dB)	Direction (H/V)
Fundamental	433.8855	82.78	-7.3	75.48	80.82	5.34	H
Harmonics	867.7710	54.69	-7.3	47.39	60.82	13.43	H
Harmonics	1301.6565	52.33	-7.3	45.03	54	8.97	H
--	--	--	--	--	--	--	--
Fundamental	433.8855	79.23	-7.3	71.93	80.82	8.89	V
Harmonics	867.7710	54.15	-7.3	46.85	60.82	13.97	V
Harmonics	1301.6565	52.19	-7.3	44.89	54	9.11	V
--	--	--	--	--	--	--	--

Note:

- Level (dBuV/m)= Reading (dBuV)+Factor(dB/m)
- AV Level (dBuV/m)= PK Level (dBuV/m)+ AV Factor(dB)
- In a transmit cycle 100ms period found burst 25pcs, the Duty Cycle can calculate as below:
- Duty Cycle= (0.370*9+1.200*16)/52.20=(3.33+19.20)/52.20=0.4316
- AV Factor=20*log(Duty Cycle)=20*log(0.4316)=-7.30

(The plot of Duty Cycle See the follow page)

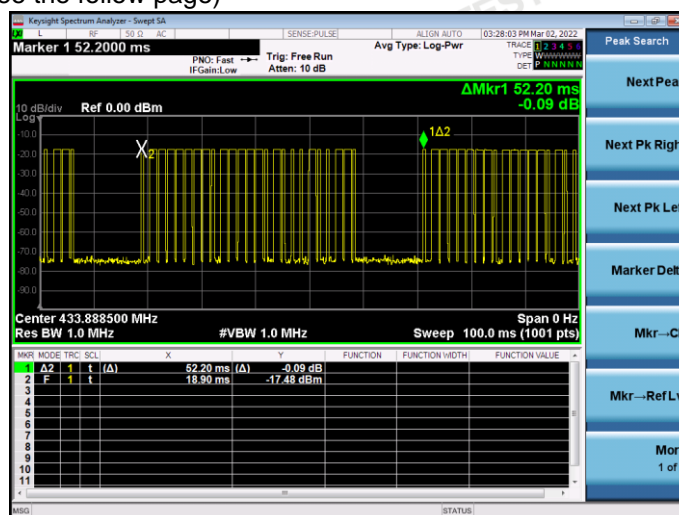

(Transmit cycle 52.20ms)

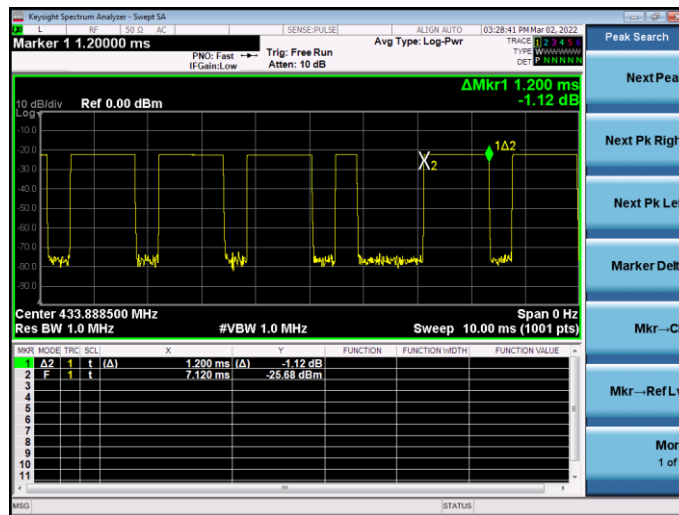

(Time per burst: 1.200ms*16pcs)



(Time per burst: 0.370ms*9pcs)

4.3 20dB Bandwidth

Limit

According to 47 CFR 15.231(c) The bandwidth of the emission shall be no wider than 0.25% of the centre frequency for devices operating above 70MHz and below 900MHz. Bandwidth is determined at the points 20dB down from the modulated carrier.

Test Configuration

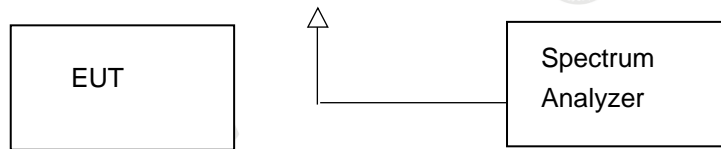

Test Procedure

The 20dB bandwidth and 99% bandwidth is measured with a spectrum analyzer connected via a receive antenna placed near the EUT while the EUT is operating in transmission mode.

The 20dB bandwidth is defined as the total spectrum the power of which is higher than peak power minus 20dB.

The occupied bandwidth (OBW), that is the frequency bandwidth such that, below its lower and above its upper frequency limits, the mean powers radiated are each equal to 0.5 percent of the total mean power radiated by a given emission.

Test Results

Modulation	Channel Frequency (MHz)	99% OBW (KHz)	20dB bandwidth (KHz)	Limit (KHz)	Result
ASK	433.8855	71.336	59.95	$0.25\% * 433.8855 = 1084.71$	Pass

Test plot as follows:

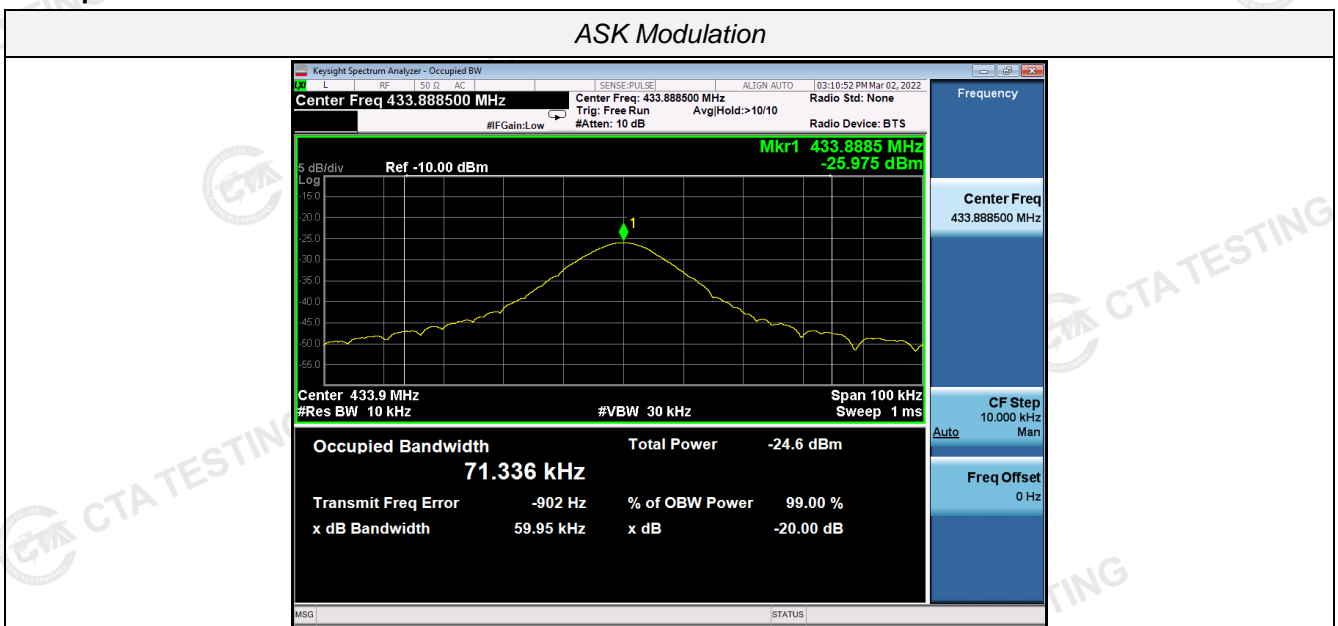

4.4 Deactivation Time

Limit

According to FCC §15.231(a)(2), A transmitter activated automatically shall cease transmission within 5 seconds after activation.

Test Configuration

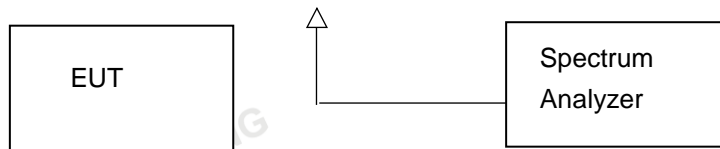

Test Procedure

1. The EUT was placed on a wooded table which is 0.8m height and close to receiver antenna of spectrum analyzer.
2. The spectrum analyzer resolution bandwidth was set to 1 MHz and video bandwidth was set to 1 MHz to encompass all significant spectral components during the test. The spectrum analyzer was operated in linear scale and zero span mode after tuning to the transmitter carrier frequency.

TEST RESULTS

Note: The transmitter was automatically activated, and the carrier frequency 433.8855MHz:

Frequency (MHz)	One transmission time (S)	Limit(S)	Result
433.8855	0.080	5	Pass

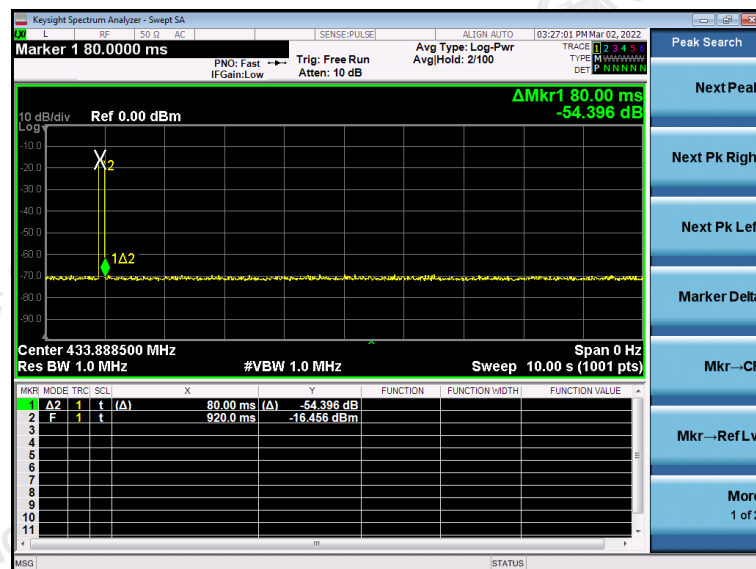

4.5 Antenna Requirement

Standard Applicable

According to FCC Part 15C 15.203

- a) An intentional radiator shall be de-signed to ensure that no antenna other than that furnished by the responsible party shall be used with the device.
- b) The manufacturer may design the unit so that a broken antenna can be replaced by the user, but the use of a standard antenna jack or electrical connector is prohibited.

Refer to statement below for compliance.

The manufacturer may design the unit so that the user can replace a broken antenna, but the use of a standard antenna jack or electrical connector is prohibited. Further, this requirement does not apply to intentional radiators that must be professionally installed.

Antenna Connected Construction

The antenna used in this product is an Internal Antenna, The directional gains of antenna used for transmitting is 0 dBi.

Remark:The antenna gain is provided by the customer , if the data provided by the customer is not accurate, Shenzhen CTA Testing Technology Co., Ltd. does not assume any responsibility.

5 Test Setup Photos of the EUT

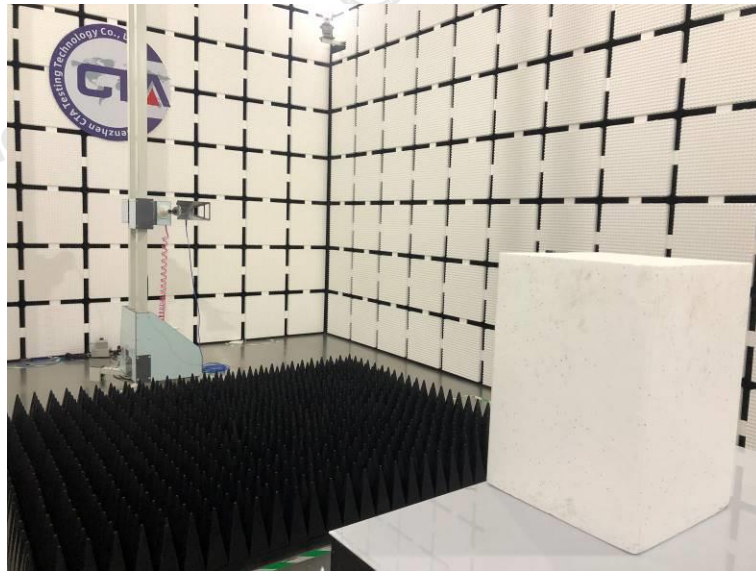
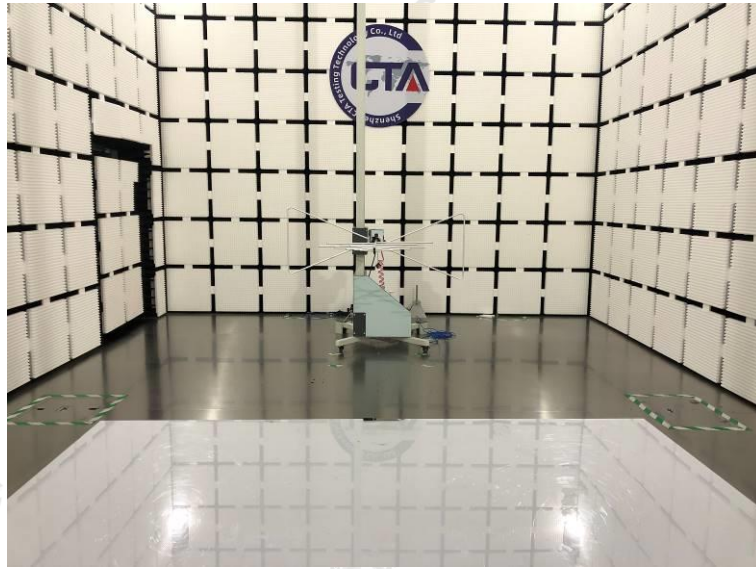

6 Photos of the EUT



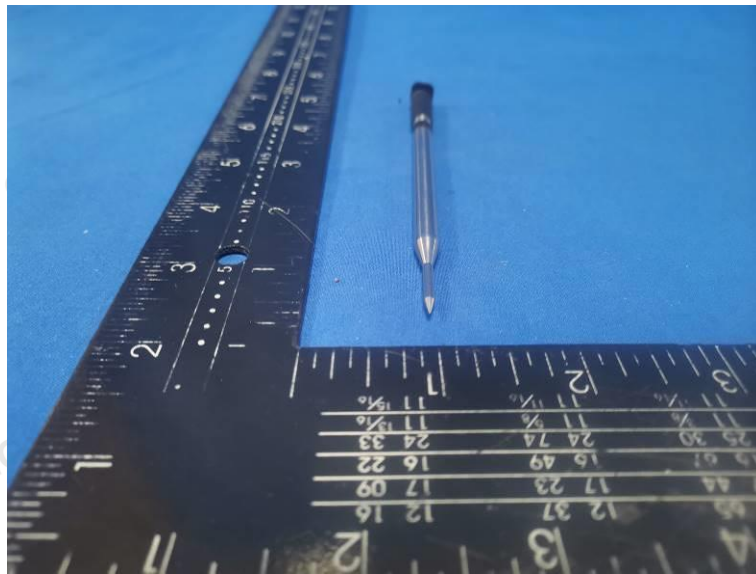
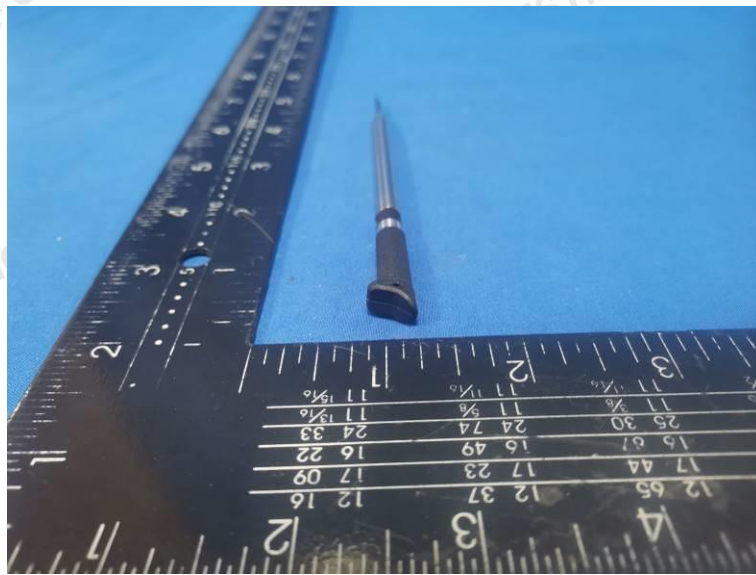
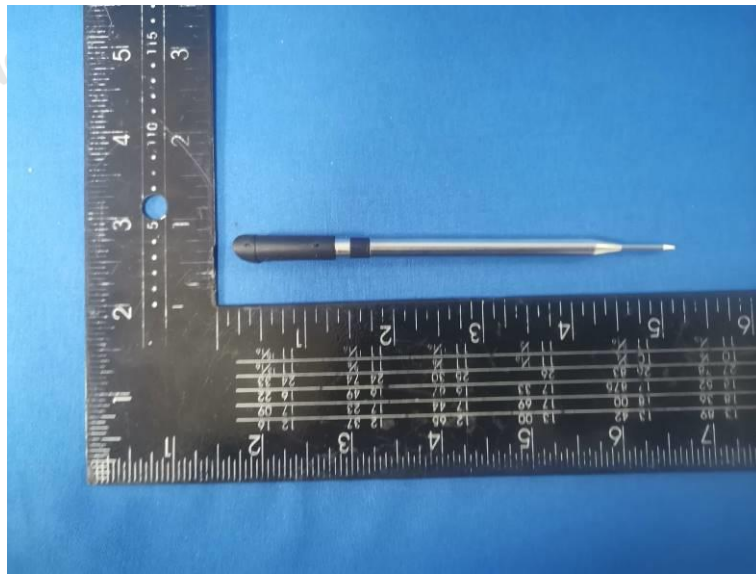

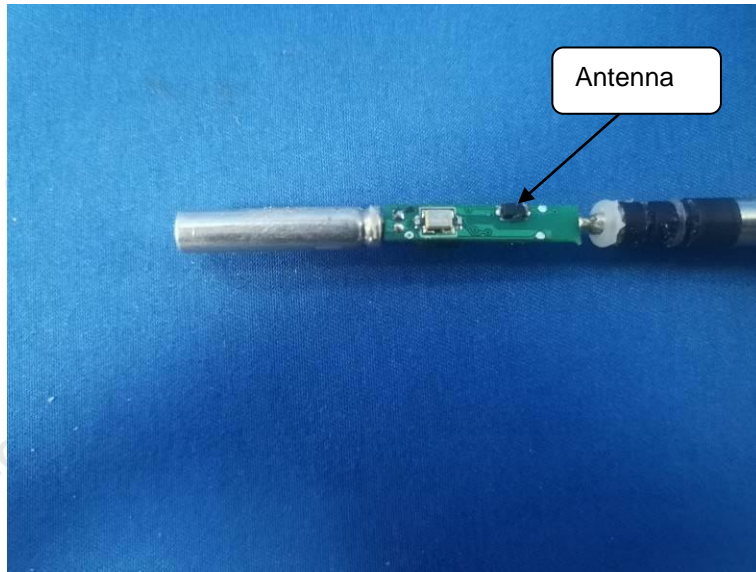

***** End of Report *****