

# Smart Cat Litter Box Instruction

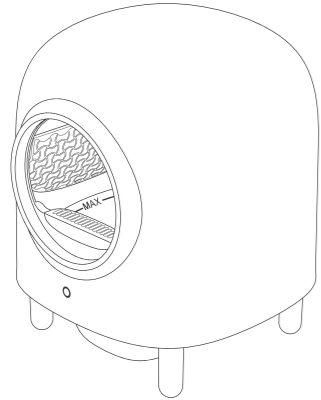

Please read the operation manual carefully and keep it properly before using the product

## Product List

Please carefully check the product list quantity

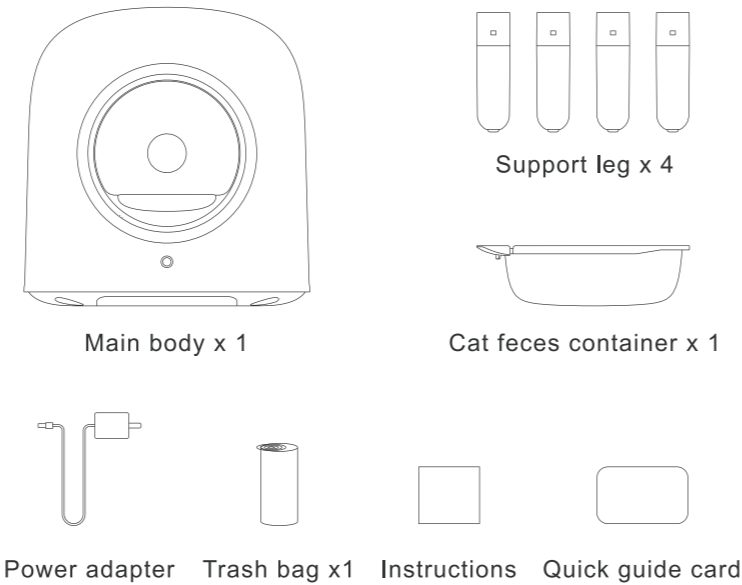

## Installation Instructions

1. Take the outer cover, take the ball compartment  
Take out the main body, remove the cover, open the lock ball and scribe, remove the ball compartment, and get the base.

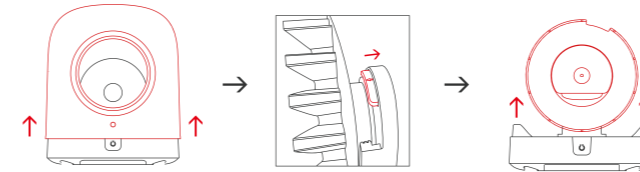

2. Put the base diagonally and install the support legs  
Place the base of the main body on the side and install 4 support legs, After the installation is complete.

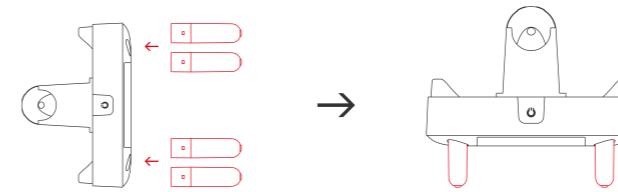

5. Power on and wait for device self-test  
Turn on the power and wait for the completion of the self-check operation of the device (the white light is always on after the self-check is completed).

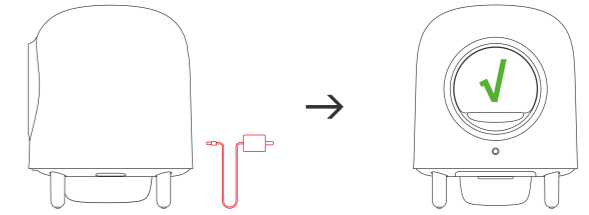

6. Add cat litter  
Add clumping cat litter from the hole. Do not add more cat litter than the MAX cat litter line. After adding the litter, click the button on the main body and wait for the end of the run to be used normally

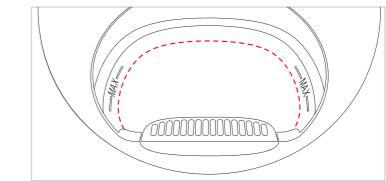

3. Install the ball compartment, install the outer cover  
Put the ball compartment back on the base, close the lock ball and scribe, and finally put on the outer cover.

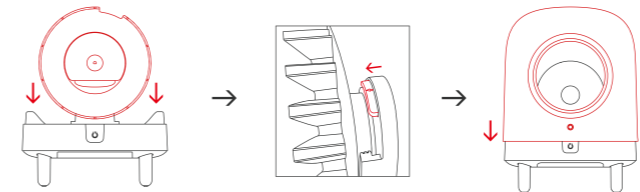

4. Install trash bag & deodorant box  
Take out the inner hoop of the cat feces container, install the deodorizing box (purchased separately), and return it after putting the garbage bag in the cat feces container to ensure that the garbage bag is not excessively upturned, then put it back into the main body

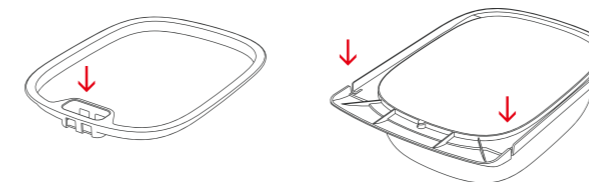

7. Distribution network  
Scan the code to download the APP, press and hold the host button, and enter the network configuration state after a long beep (please place the device in a WiFi coverage environment), open the APP, follow the APP instructions to add the device and connect to the network.



Scan code to download APP

### Distribution network precautions

1. The litter box only supports 2.4G WiFi, not 5G WiFi
2. The mobile phone needs to turn on Bluetooth when configuring the network
3. If the APP cannot find the device, please power off the device for 5 seconds and then restart it
4. Only one account can be added to a device, and the device can be shared with other users in the APP
5. If the power is interrupted during operation, it will automatically return to the horizontal position after power on

## Statement

Thank you for purchasing our smart cat litter box. We're committed to making your pet life better through the power of design. This instruction will help you better understand and use this product.

## User Notice

1. Please install and use this product according to the instructions
2. This device needs to be placed on a level ground
3. No items are allowed on the top of the device
4. Don't use in a high temperature and high humidity environment
5. Don't use non-clumping cat litter
6. Don't place foreign objects in the ball room
7. Don't force the cat into the ball room
8. The automatic mode of the device is not suitable for cats younger than 6 months
9. The base part is forbidden to wash

## Product Introduction

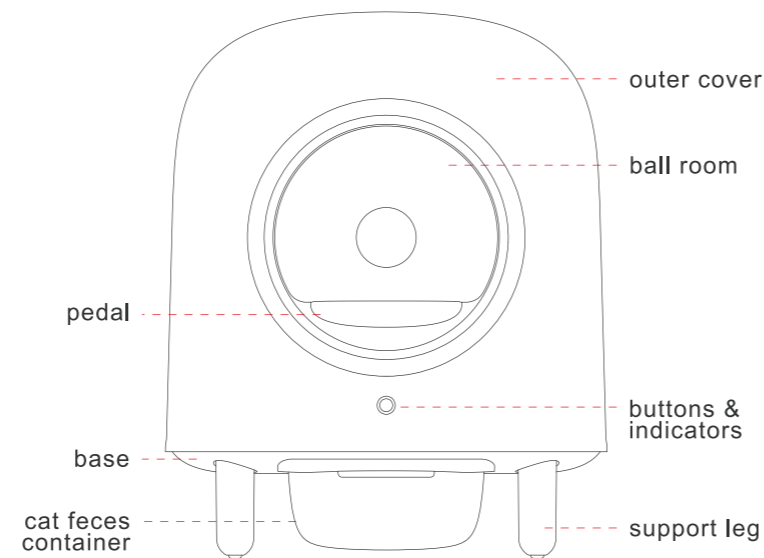

## Button and light description

main body button	single press	start/pause/continue	clean function
		pause/continue	empty litter function
	double press	start up	dumping cat litter function
	long press for 3 seconds	running status	cancel the running function
standby state		enter the distribution mode	

indicator light	white light	fast flashing	paired network mode or program upgrading
		slow flashing	cleaning mode or sand dumping mode is running
		breathing changes	turn on do not disturb
		always on	standby state
	red light	slow flashing	triggered the sensor
			the cover is not placed
	always on	cat feces container full	



## Function Description

- Automatic cleaning function**  
After the cat leaves the toilet, the machine starts cleaning 3 minutes later. If the cat enters during operation, the machine will stop and continues to operate after the cat leaves
- Device information push function**  
When the machine is connected to WiFi and added to the app the current status information of the machine will be pushed to the app in real time.
- Dumping cat litter function**  
Double click the host button or click the sand dumping button on the app. If the cat enters during operation, the equipment will stop and continue to run after the cat leaves
- Smart deodorizing function**  
Smart deodorization is always on by default under normal conditions. In the "mode" button of app, the "automatic deodorization" function can be turned off
- Do not disturb mode function**  
Click the "do not disturb mode" button in the app, and the equipment will enter the mode at the corresponding time every day without any operation

## Common problems and Solutions

- How old cats can use the device?**  
The automatic function of this product is applicable to cats over 4 months old and weighing more than 1kg. If the cat's weight or age does not meet the standard, do not use the automatic excrement removal function. You can choose to turn on the device in the do not disturb mode for 24 hours and manually turn on the excrement removal function
- What if the cat doesn't want to use the new litter box?**  
If the cat has strong vigilance, can place machine next to the old litter box for a period of time, and put some old litter with the smell of the cat into the new equipment. The familiar smell will also make the cat more easy to adapt
- Is it dangerous for cats to enter when the ball rotates?**  
If a cat enters the ball bin when it rotates, the monitoring sensor will be triggered immediately, the ball room will stop rotating immediately, and the equipment will continue to operate after the cat leaves the ball room for a period of time. Therefore, there is no need to worry that the cat will enter the running ball room
- What types of cat litter can I use?**  
This product supports most agglomerated cat litter (tofu sand, mixed sand, etc.)  
Do not use non agglomerated or poorly agglomerated sand (crystal sand, wood-based sand, etc.)
- How much cat litter should I add?**  
It's recommended to add about 4L cat litter for the first time. Do not exceed the max sand level line. Excess sand will be filtered into the cat feces container during operation
- When should I replenish cat litter?**  
It can be determined according to the specific use situation. It's recommended to supplement cat litter when the remaining half of the cat litter is used
- How often does it take to clean the cat feces container?**  
It can be determined according to the specific use situation (factors such as the number of cats)  
It's recommended to replace it once every 3~5 days in the case of one cat (the frequency needs to be increased in hot weather)
- How often does it take to clean the ball room?**  
It can be determined according to the specific use conditions (number of cats or defecation status of cats, etc.)  
it's recommended to wash once every 1~3 months if it's possible

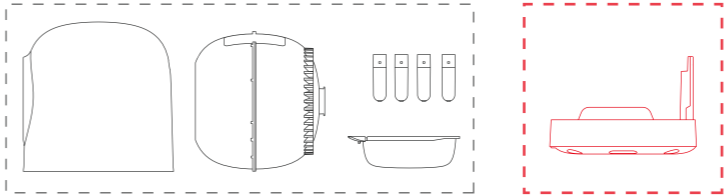

## Cleaning Instruction

- Remove residual litter**  
Double click the host button (or click the "sand dumping" button on the app) to start the sand dumping function (too much residual sand may trigger the prompt that the toilet bin is full. Shaking the toilet bin can reduce the risk of cat litter scattering)
- Disassembly and Cleaning**  
Take down the cat feces container, take down the cover, open the ball room scribe and take down the ball room  
  
Washable                      Non Washable
- Dry and Assemble**  
After the cleaning is completed and the machine is dried, install the ball room, cover and cat feces container in turn. If the red light flashes after the installation is powered on, check whether the cover is installed in place



## Quick troubleshooting

- Shortly after turn on, the "drip sound" of the equipment will sound for a short time and flash with the red light**  
Try to readjust the position of the cover.
- The machine stops suddenly during operation, and the red light flashes**  
The machine senses the entry of objects into and starts the pause program. After the delay, it will resume operation. (when the agglomerate is too large or the rolling speed is too fast, it may also trigger the stop)
- The red light of the machine is always on, and the cleaning program cannot be started**  
Check whether the trash box is full.
- During sand dumping, the machine stops and the red light is always on**  
If the amount of residual sand is too large, resulting in the trash box full, shake the cat feces container back and forth to smooth the residual sand or dump it twice (it needs to be started manually after stopping, so there is no need to worry about dumping the remaining cat litter automatically)

## Description of hazardous substances

Part	Hazardous substances					
	Pb	Hg	Cd	Cr(VI)	PBB	PBDE
Cover	○	○	○	○	○	○
PCBA	×	○	○	○	○	○
Wire	×	○	○	○	○	○
Metal	×	○	×	○	○	○
Adapter	×	○	×	○	○	○

○: Indicates that the content of the hazardous substance in all homogeneous materials of the component is below the limit specified in GB / T 26572.  
×: Indicates that the content of the hazardous substance in at least one homogeneous material of the component exceeds the limit specified in GB / T 26572.

## Product Parameters

Name	Smart Automatic cat litter box
Style No.	N1
Product Size	520 x 520 x 670 (mm)
N.W.	10KG
Rated voltage	12V~ 1A
Standard	GB4706.1-2005

FCC Statement  
This equipment has been tested and found to comply with the limits for a Class B digital device, pursuant to Part 15 of the FCC Rules. These limits are designed to provide reasonable protection against harmful interference in a residential installation. This equipment generates uses and can radiate radio frequency energy and, if not installed and used in accordance with the instructions, may cause harmful interference to radio communications. However, there is no guarantee that interference will not occur in a particular installation. If this equipment does cause harmful interference to radio or television reception, which can be determined by turning the equipment off and on, the user is encouraged to try to correct the interference by one or more of the following measures:  
-- Reorient or relocate the receiving antenna.  
-- Increase the separation between the equipment and receiver.  
-- Connect the equipment into an outlet on a circuit different from that to which the receiver is connected.  
-- Consult the dealer or an experienced radio/TV technician for help.

This device complies with part 15 of the FCC Rules. Operation is subject to the following two conditions:  
(1) This device may not cause harmful interference, and (2) this device must accept any interference received, including interference that may cause undesired operation.

Changes or modifications not expressly approved by the party responsible for compliance could void the user's authority to operate the equipment

Please feel free to contact our customer service via [service.amazon@hhocool.com](mailto:service.amazon@hhocool.com). We will get back to you within 24 hours.

尺寸：240mm x 480mm

风琴三折页后再对折

157g铜版纸不覆膜