

1. Antenna Description:

Antenna plate	Monopole Antenna
Antenna peak gain	2.3 dBi
Frequency range	2.402MHz~2.480MHz
Connect type	Direct Connect

2. Picture of antenna

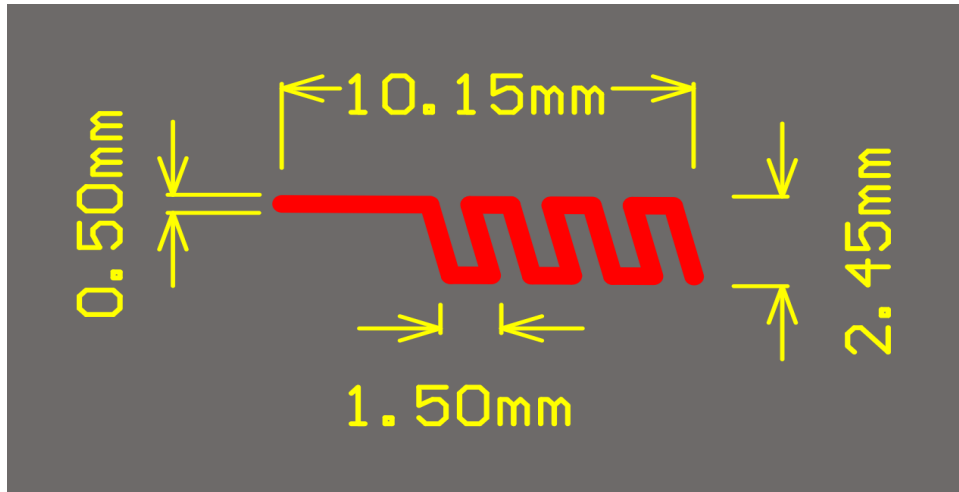

3. Antenna Radiation Pattern

Radiation pattern @2.402GHz

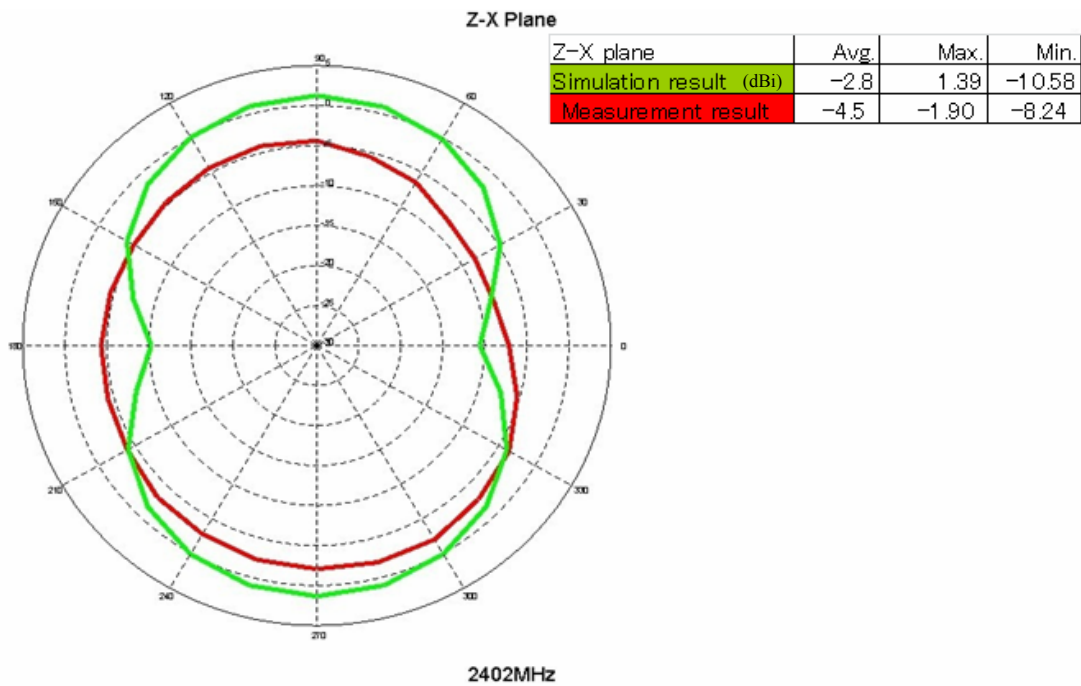

Z-Y Plane

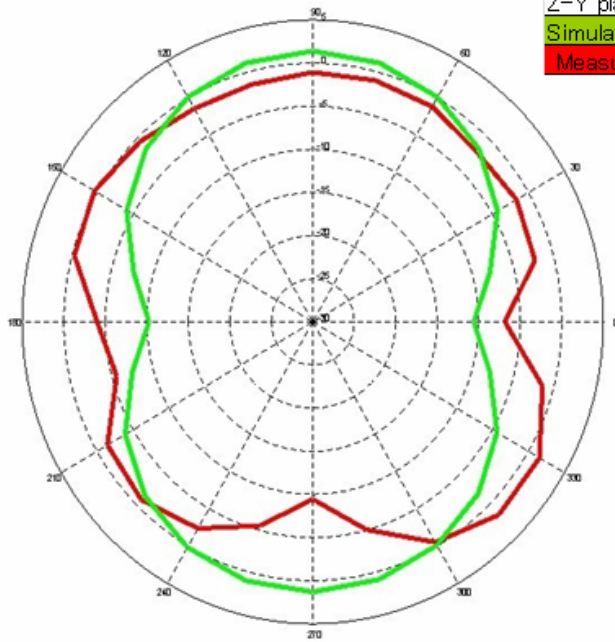

Z-Y plane	Avg.	Max.	Min.
Simulation result (dBi)	-2.8	1.45	-10.58
Measurement result	-2.1	1.7	-9.42

2402MHz

X-Y Plane

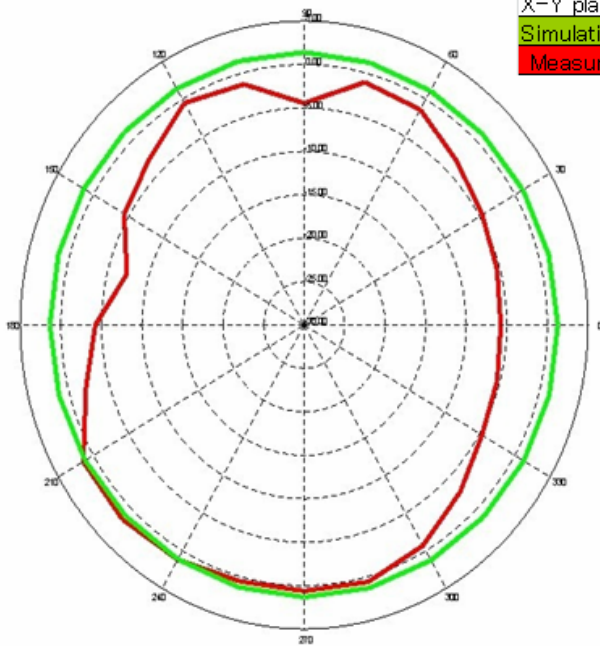

X-Y plane	Avg.	Max.	Min.
Simulation result (dBi)	1.3	1.5	1.15
Measurement result	-2.3	1.7	-7.34

2402MHz

Radiation pattern @2.441GHz

Z-X Plane

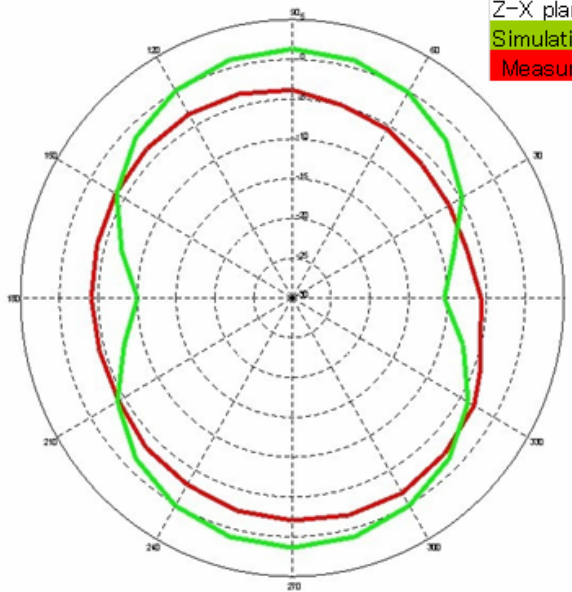

Z-X plane	Avg.	Max.	Min.
Simulation result (dBi)	-2.7	1.44	-10.39
Measurement result	-3.9	-1.65	-6.68

2441MHz

Z-Y Plane

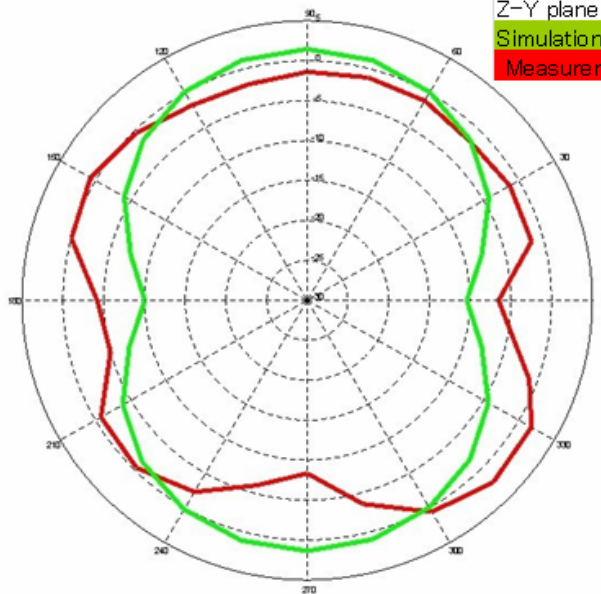

Z-Y plane	Avg.	Max.	Min.
Simulation result (dBi)	-1.7	1.5	-10.39
Measurement result	-1.8	2.3	-8.31

2441MHz

X-Y Plane

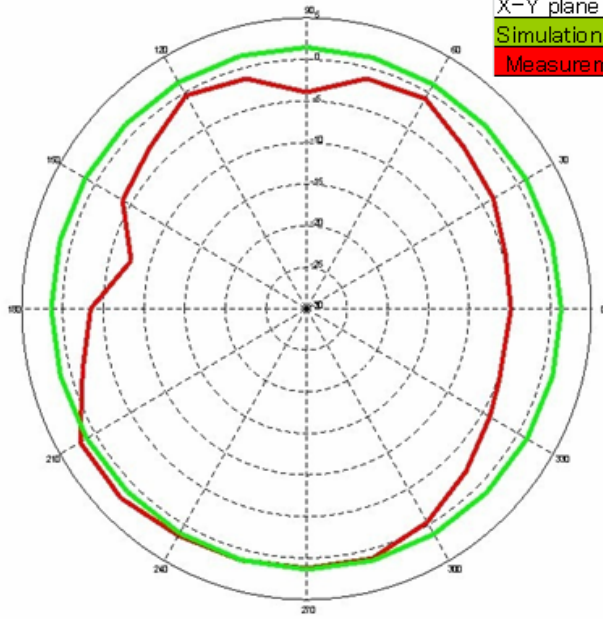

X-Y plane	Avg.	Max.	Min.
Simulation result (dBi)	1.4	1.55	1.17
Measurement result	-1.8	2.3	-7.64

2441MHz

Radiation pattern @2.480GHz

Z-X Plane

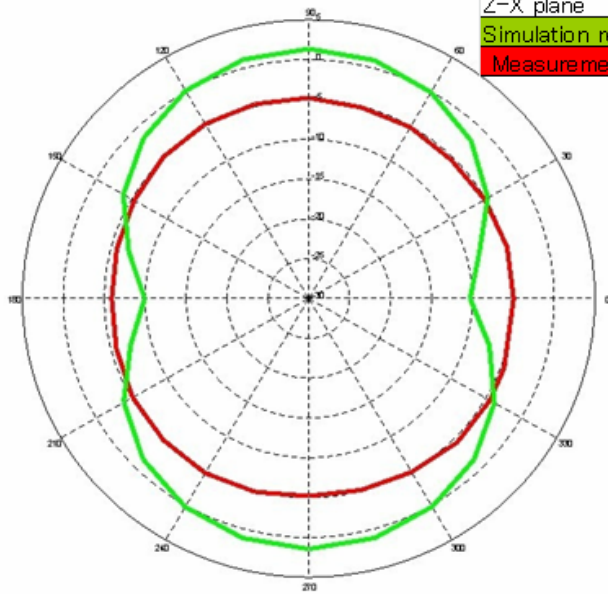

Z-X plane	Avg.	Max.	Min.
Simulation result (dBi)	-2.7	1.5	-10.25
Measurement result	-5.0	-4.35	-5.88

2480MHz

Z-Y Plane

Z-Y plane	Avg.	Max.	Min.
Simulation result (dBi)	-2.7	1.55	-10.25
Measurement result	-2.8	1.82	-6.16

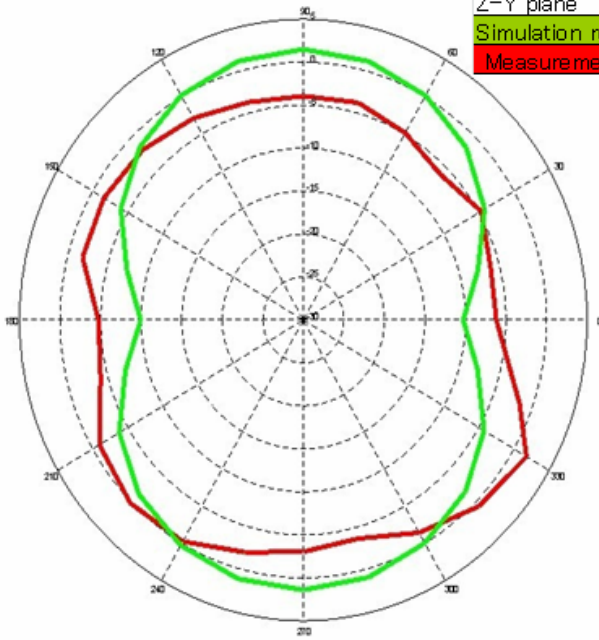

2480MHz

X-Y Plane

X-Y plane	Avg.	Max.	Min.
Simulation result (dBi)	1.4	1.61	1.22
Measurement result	-2.3	1.82	-8.38

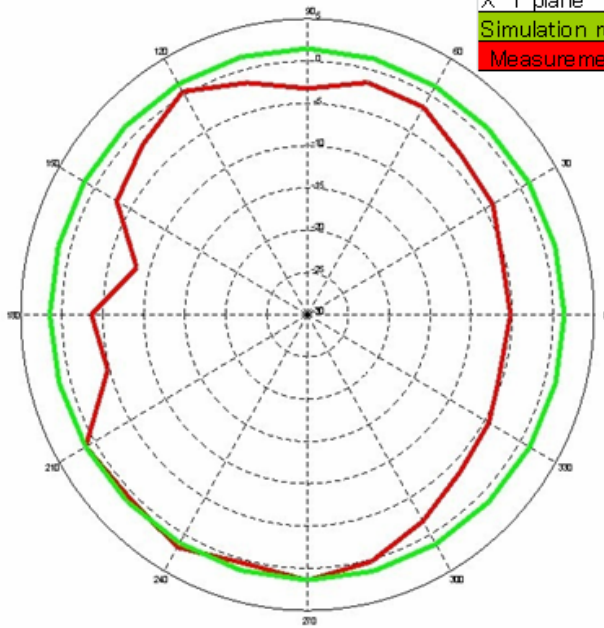

2480MHz