

S

T

S

L

A

B



## RADIO TEST REPORT

Report No.:STS2210055W02

Issued for

Chongqing Huiye lot Technology Co., Ltd.

No.4 Of No.6 Comprehensive Tax Avenue, Shapingba Districh,  
Chongqing, China

<b>Product Name:</b>	LCD Display
<b>Brand:</b>	 The brand logo for HUIYE, featuring a stylized red and black graphic above the word 'HUIYE' in a bold, black, sans-serif font.
<b>Model Number:</b>	B02U
<b>Series Model(s):</b>	B02C
<b>FCC ID:</b>	2A5B3-B02
<b>Test Standard:</b>	FCC Part 15.247

Any reproduction of this document must be done in full. No single part of this document may be reproduced without permission from STS, all test data presented in this report is only applicable to presented test sample.

Shenzhen STS Test Services Co., Ltd.  
A 1/F, Building B, Zhuoke Science Park, No.190 Chongqing Road, HepingShequ,  
Fuyong Sub-District, Bao'an District, Shenzhen, Guang Dong, China  
TEL: +86-755 3688 6288 FAX: +86-755 3688 6277 E-mail:sts@ststest.com





### TEST RESULT CERTIFICATION

**Applicant's Name**.....: Chongqing Huiye lot Technology Co., Ltd.  
 Address .....: No.4 Of No.6 Comprehensive Tax Avenue, Shapingba Districh, Chongqing, China  
**Manufacturer's Name** .....: Chongqing Huiye lot Technology Co., Ltd.  
 Address .....: No.4 Of No.6 Comprehensive Tax Avenue, Shapingba Districh, Chongqing, China

#### Product Description

Product Name.....: LCD Display  
 Brand .....:   
 Model Number .....: B02U  
 Series Model(s) .....: B02C  
**Test Standards**.....: FCC Part15.247  
 Test Procedure .....: ANSI C63.10-2013

This device described above has been tested by STS, the test results show that the equipment under test (EUT) is in compliance with the FCC requirements. And it is applicable only to the tested sample identified in the report.  
 This report shall not be reproduced except in full, without the written approval of STS, this document may be altered or revised by STS, personal only, and shall be noted in the revision of the document.

**Date of Test**.....:  
 Date of receipt of test item .....: 18 Oct. 2022  
 Date (s) of performance of tests .....: 18 Oct. 2022 ~ 25 Oct. 2022  
 Date of Issue.....: 25 Oct. 2022  
 Test Result.....: **Pass**

Testing Engineer : 

(Chris Chen)

Technical Manager : 

(Sean she)

Authorized Signatory : 

(Bovey Yang)





## Table of Contents

<b>1. SUMMARY OF TEST RESULTS</b>	<b>6</b>
1.1 TEST FACTORY	7
1.2 MEASUREMENT UNCERTAINTY	7
<b>2. GENERAL INFORMATION</b>	<b>8</b>
2.1 GENERAL DESCRIPTION OF THE EUT	8
2.2 DESCRIPTION OF THE TEST MODES	9
2.3 TEST SOFTWARE AND POWER LEVEL	9
2.4 BLOCK DIAGRAM SHOWING THE CONFIGURATION OF SYSTEM TESTED	10
2.5 DESCRIPTION OF NECESSARY ACCESSORIES AND SUPPORT UNITS	11
2.6 EQUIPMENTS LIST	12
<b>3. EMC EMISSION TEST</b>	<b>14</b>
3.1 CONDUCTED EMISSION MEASUREMENT	14
3.2 TEST PROCEDURE	15
3.3 TEST SETUP	15
3.4 EUT OPERATING CONDITIONS	15
3.5 TEST RESULTS	16
<b>4. RADIATED EMISSION MEASUREMENT</b>	<b>17</b>
4.1 RADIATED EMISSION LIMITS	17
4.2 TEST PROCEDURE	19
4.3 TEST SETUP	20
4.4 EUT OPERATING CONDITIONS	20
4.5 FIELD STRENGTH CALCULATION	20
4.6 TEST RESULTS	22
<b>5. CONDUCTED SPURIOUS &amp; BAND EDGE EMISSION</b>	<b>29</b>
5.1 LIMIT	29
5.2 TEST PROCEDURE	29
5.3 TEST SETUP	29
5.4 EUT OPERATION CONDITIONS	29
5.5 TEST RESULTS	29
<b>6. POWER SPECTRAL DENSITY TEST</b>	<b>30</b>
6.1 LIMIT	30
6.2 TEST PROCEDURE	30
6.3 TEST SETUP	30



## Table of Contents

6.4 EUT OPERATION CONDITIONS	30
6.5 TEST RESULTS	30
<b>7. BANDWIDTH TEST</b>	<b>31</b>
7.1 LIMIT	31
7.2 TEST PROCEDURE	31
7.3 TEST SETUP	31
7.4 EUT OPERATION CONDITIONS	31
7.5 TEST RESULTS	31
<b>8. PEAK OUTPUT POWER TEST</b>	<b>32</b>
8.1 LIMIT	32
8.2 TEST PROCEDURE	32
8.3 TEST SETUP	33
8.4 EUT OPERATION CONDITIONS	33
8.5 TEST RESULTS	33
<b>9. ANTENNA REQUIREMENT</b>	<b>34</b>
9.1 STANDARD REQUIREMENT	34
9.2 EUT ANTENNA	34
<b>APPENDIX 1-TEST DATA</b>	<b>35</b>
1. DUTY CYCLE	35
2. MAXIMUM AVERAGE CONDUCTED OUTPUT POWER	38
3. MAXIMUM PEAK CONDUCTED OUTPUT POWER	41
4. -6DB BANDWIDTH	44
5. MAXIMUM POWER SPECTRAL DENSITY LEVEL	47
6. BAND EDGE	50
7. CONDUCTED RF SPURIOUS EMISSION	53
<b>APPENDIX 2- EUT TEST PHOTO</b>	<b>57</b>



**Revision History**

Rev.	Issue Date	Report NO.	Effect Page	Contents
00	25 Oct. 2022	STS2210055W02	ALL	Initial Issue





## 1. SUMMARY OF TEST RESULTS

Test procedures according to the technical standards:  
KDB 558074 D01 15.247 Meas Guidance v05r02.

FCC Part 15.247, Subpart C			
Standard Section	Test Item	Judgment	Remark
15.207	Conducted Emission	N/A	--
15.247 (a)(2)	6dB Bandwidth	PASS	--
15.247 (b)(3)	Output Power	PASS	--
15.209	Radiated Spurious Emission	PASS	--
15.247 (d)	Conducted Spurious & Band Edge Emission	PASS	--
15.247 (e)	Power Spectral Density	PASS	--
15.205	Restricted bands of operation	PASS	--
Part 15.247(d)/ Part 15.209(a)	Band Edge Emission	PASS	--
15.203	Antenna Requirement	PASS	--

### NOTE:

- (1) 'N/A' denotes test is not applicable in this Test Report.
- (2) All tests are according to ANSI C63.10-2013.



### 1.1 TEST FACTORY

SHENZHEN STS TEST SERVICES CO., LTD

Add. : A 1/F, Building B, Zhuoke Science Park, No.190 Chongqing Road, HepingShequ, Fuyong Sub-District, Bao'an District, Shenzhen, Guang Dong, China

FCC test Firm Registration Number: 625569

IC test Firm Registration Number: 12108A

A2LA Certificate No.: 4338.01

### 1.2 MEASUREMENT UNCERTAINTY

The reported uncertainty of measurement  $y \pm U$ , where expanded uncertainty  $U$  is based on a standard uncertainty multiplied by a coverage factor of  $k=2$ , providing a level of confidence of approximately **95** %.

No.	Item	Uncertainty
1	RF output power, conducted	$\pm 0.87\text{dB}$
2	Unwanted Emissions, conducted	$\pm 2.895\text{dB}$
3	All emissions, radiated 9K-30MHz	$\pm 3.80\text{dB}$
4	All emissions, radiated 30M-1GHz	$\pm 4.09\text{dB}$
5	All emissions, radiated 1G-6GHz	$\pm 4.92\text{dB}$
6	All emissions, radiated >6G	$\pm 5.49\text{dB}$
7	Conducted Emission (9KHz-30MHz)	$\pm 2.73\text{dB}$



## 2. GENERAL INFORMATION

### 2.1 GENERAL DESCRIPTION OF THE EUT

Product Name	LCD Display																
Brand																	
Model Number	B02U																
Series Model(s)	B02C																
Model Difference	The difference between model B02U and B02C is that B02U does not install equipment materials on the data end, while B02C installs backup materials on the data end																
Product Description	<table border="1"><tr><td colspan="2">The EUT is a LCD Display</td></tr><tr><td>Operation Frequency:</td><td>2402~2480 MHz</td></tr><tr><td>Modulation Type:</td><td>GFSK</td></tr><tr><td>Radio Technology:</td><td>BLE</td></tr><tr><td>Bluetooth Configuration:</td><td>LE(Support 1M PHY)</td></tr><tr><td>Number Of Channel:</td><td>40</td></tr><tr><td>Antenna Type:</td><td>PCB</td></tr><tr><td>Antenna Gain (dBi)</td><td>-5dBi</td></tr></table>	The EUT is a LCD Display		Operation Frequency:	2402~2480 MHz	Modulation Type:	GFSK	Radio Technology:	BLE	Bluetooth Configuration:	LE(Support 1M PHY)	Number Of Channel:	40	Antenna Type:	PCB	Antenna Gain (dBi)	-5dBi
The EUT is a LCD Display																	
Operation Frequency:	2402~2480 MHz																
Modulation Type:	GFSK																
Radio Technology:	BLE																
Bluetooth Configuration:	LE(Support 1M PHY)																
Number Of Channel:	40																
Antenna Type:	PCB																
Antenna Gain (dBi)	-5dBi																
Channel List	Please refer to the Note 3.																
Rating	Input: DC12V~60V, 2A																
Hardware version number	B02_MB_PCB_V1.02																
Software version number	N/A																
Connecting I/O Port(s)	Please refer to the Note 1.																

Note:

1. For a more detailed features description, please refer to the manufacturer's specifications or the User Manual.
2. Note: The antenna information refer the manufacturer provide report, applicable only to the tested sample identified in the report. Due to the incorrect antenna information, a series of problems such as the accuracy of the test results will be borne by the customer.





3.

Channel List							
Channel	Frequency (MHz)	Channel	Frequency (MHz)	Channel	Frequency (MHz)	Channel	Frequency (MHz)
00	2402	10	2422	20	2442	30	2462
01	2404	11	2424	21	2444	31	2464
02	2406	12	2426	22	2446	32	2466
03	2408	13	2428	23	2448	33	2468
04	2410	14	2430	24	2450	34	2470
05	2412	15	2432	25	2452	35	2472
06	2414	16	2434	26	2454	36	2474
07	2416	17	2436	27	2456	37	2476
08	2418	18	2438	28	2458	38	2478
09	2420	19	2440	29	2460	39	2480

## 2.2 DESCRIPTION OF THE TEST MODES

For conducted test items and radiated spurious emissions

Each of these EUT operation mode(s) or test configuration mode(s) mentioned below was evaluated respectively.

Worst Mode	Description	Data/Modulation
Mode 1	TX CH00(2402MHz)	1 Mbps/GFSK
Mode 2	TX CH19(2440MHz)	1 Mbps/GFSK
Mode 3	TX CH39(2480MHz)	1 Mbps/GFSK

Note:

(1) We tested for all available U.S. voltage and frequencies (For 120V, 50/60Hz and 240V, 50/60Hz) for which the device is capable of operation, and the worst case of 120V/ 60Hz is shown in the report.

(2) The battery is fully-charged during the radiated and RF conducted test.

## 2.3 TEST SOFTWARE AND POWER LEVEL

During testing channel & power controlling software provided by the customer was used to control the operating channel as well as the output power level.

RF Function	Type	Mode Or Modulation type	ANT Gain(dBi)	Power Class	Software For Testing
BLE	BLE	GFSK	-5	0	MauiMETA_v8.1520.9



## 2.4 BLOCK DIAGRAM SHOWING THE CONFIGURATION OF SYSTEM TESTED

### Radiated Spurious Emission Test

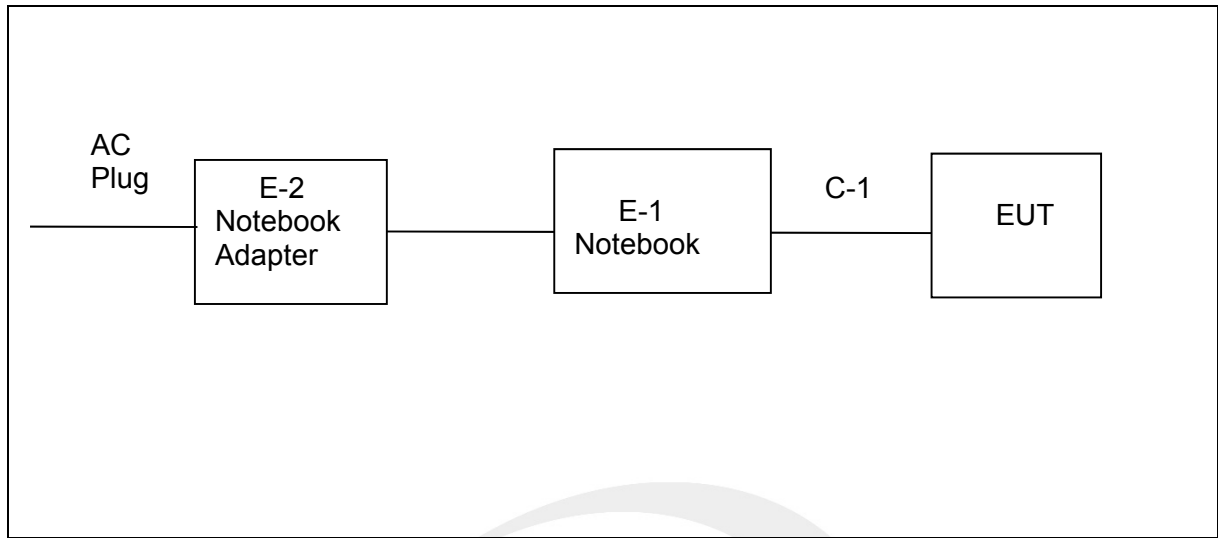



## 2.5 DESCRIPTION OF NECESSARY ACCESSORIES AND SUPPORT UNITS

The EUT has been tested as an independent unit together with other necessary accessories or support units. The following support units or accessories were used to form a representative test configuration during the tests.

### Necessary accessories

Item	Equipment	Mfr/Brand	Model/Type No.	Length	Note
N/A	N/A	N/A	N/A	N/A	N/A

### Support units

Item	Equipment	Mfr/Brand	Model/Type No.	Length	Note
E-1	Notebook	LENOVO	Think Pad E470	N/A	N/A
E-2	Notebook Adapter	LENOVO	ADLX45DLC3A	N/A	N/A
C-1	USB Cable	N/A	N/A	150cm	NO

#### Note:

- (1) For detachable type I/O cable should be specified the length in cm in 『Length』 column.
- (2) “YES” is means “with core”; “NO” is means “without core”.



2.6 EQUIPMENTS LIST

Radiation Test equipment

Kind of Equipment	Manufacturer	Type No.	Serial No.	Last calibration	Calibrated until
Temperature & Humidity	SW-108	SuWei	N/A	2022.03.02	2023.03.01
Pre-Amplifier(0.1M-3 GHz)	EM	EM330	060665	2022.07.04	2023.07.03
Pre-Amplifier (1G-18GHz)	SKET	LNPA-01018G-45	SK2018080901	2022.09.29	2023.09.28
Pre-mpifier(18G-40G)	SKET	LNPA_1840-50	SK2018101801	2022.07.23	2023.07.22
Positioning Controller	MF	MF-7802	MF-780208587	N/A	N/A
Signal Analyzer	R&S	FSV 40-N	101823	2022.09.29	2023.09.28
Switch Control Box	N/A	N/A	N/A	N/A	N/A
Filter Box	BALUN Technology	SU319E	BL-SZ1530051	N/A	N/A
Active loop Antenna	ZHINAN	ZN30900C	16035	2022.03.02	2023.03.01
Bilog Antenna	TESEQ	CBL6111D	34678	2022.09.30	2024.09.29
Horn Antenna	SCHWARZBECK	BBHA 9120D	02014	2021.10.11	2023.10.10
Horn Antenna	A-INFOMW	LB-180400-KF	J211020657	2021.09.28	2023.09.27
Antenna Mast	MF	MFA-440H	N/A	N/A	N/A
Turn Table	MF	SC100_1	60531	N/A	N/A
AC Power Source	APC	KDF-11010G	F214050035	N/A	N/A
DC Power Supply	Zhaoxin	RXN 605D	20R605D11010081	N/A	N/A
Test SW	EZ-EMC	Ver.STSLAB-03A1 RE			

Conduction Test equipment

Kind of Equipment	Manufacturer	Type No.	Serial No.	Last calibration	Calibrated until
Test Receiver	R&S	ESCI	101427	2022.09.29	2023.09.28
LISN	R&S	ENV216	101242	2022.09.28	2023.09.27
LISN	EMCO	3810/2NM	23625	2022.09.28	2023.09.27
Temperature & Humidity	HH660	Mieo	N/A	2022.09.30	2023.09.29
Test SW	EZ-EMC	Ver.STSLAB-03A1 CE			



## RF Connected Test

Kind of Equipment	Manufacturer	Type No.	Serial No.	Last calibration	Calibrated until
Signal Analyzer	Agilent	N9020A	MY51510623	2022.03.01	2023.02.28
Switch control box	MW	MW100-RFCB	N/A	N/A	N/A
Temperature & Humidity	HH660	Mieo	N/A	2022.09.30	2023.09.29
Test SW	MW	MTS 8310_2.0.0.0			





### 3. EMC EMISSION TEST

#### 3.1 CONDUCTED EMISSION MEASUREMENT

##### 3.1.1 POWER LINE CONDUCTED EMISSION LIMITS

The radio frequency voltage that is conducted back onto the AC power line on any frequency or frequencies, within the band 150 kHz to 30 MHz, shall not exceed the limits in the following table.

FREQUENCY (MHz)	Conducted Emission limit (dBuV)	
	Quasi-peak	Average
0.15 -0.5	66 - 56 *	56 - 46 *
0.50 -5.0	56.00	46.00
5.0 -30.0	60.00	50.00

Note:

- (1) The tighter limit applies at the band edges.
- (2) The limit of “ \* ” marked band means the limitation decreases linearly with the logarithm of the frequency in the range.

The following table is the setting of the receiver

Receiver Parameters	Setting
Attenuation	10 dB
Start Frequency	0.15 MHz
Stop Frequency	30 MHz
IF Bandwidth	9 kHz

### 3.2 TEST PROCEDURE

- a. The EUT is 0.8 m from the horizontal ground plane and 0.4 m from the vertical ground plane with EUT being connected to the power mains through a line impedance stabilization network (LISN). All other support equipments are powered from additional LISN(s). The LISN provides 50 Ohm/ 50uH of coupling impedance for the measuring instrument.
- b. Interconnecting cables that hang closer than 40 cm to the ground plane shall be folded back and forth in the center forming a bundle 30 to 40 cm long.
- c. I/O cables that are not connected to a peripheral shall be bundled in the center. The end of the cable may be terminated, if required, using the correct terminating impedance. The overall length shall not exceed 1 m.
- d. LISN is at least 80 cm from the nearest part of EUT chassis.
- e. For the actual test configuration, please refer to the related Item –EUT Test Photos.

### 3.3 TEST SETUP

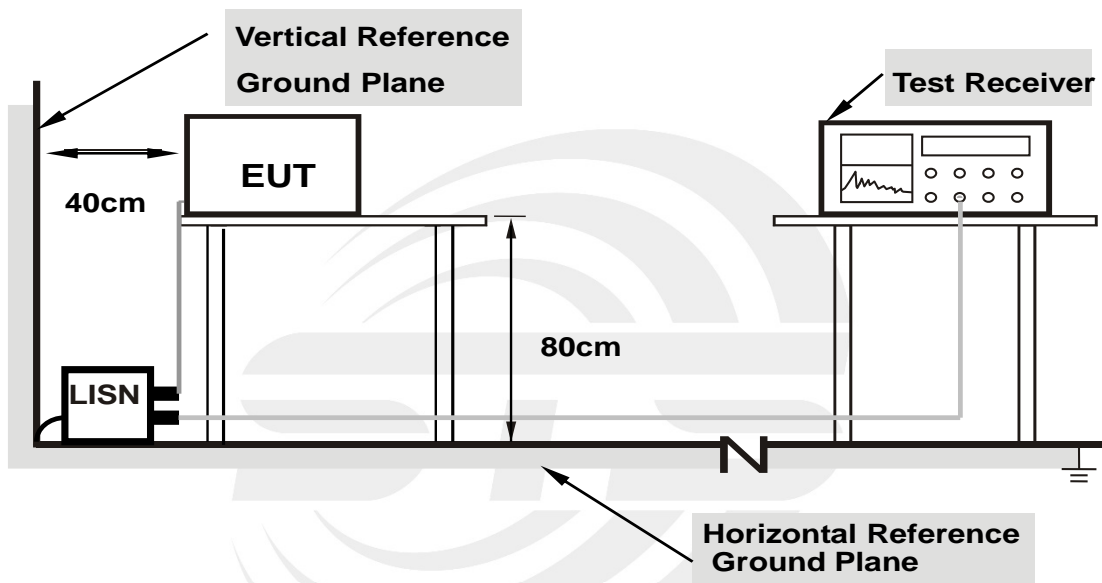

- Note: 1. Support units were connected to second LISN.**
- 2. Both of LISNs (AMN) are 80 cm from EUT and at least 80 cm from other units and other metal planes support units.**

### 3.4 EUT OPERATING CONDITIONS

The EUT was configured for testing in a typical fashion (as a customer would normally use it). The EUT has been programmed to continuously transmit during test. This operating condition was tested and used to collect the included data.



## 3.5 TEST RESULTS

Temperature:	--(C)	Relative Humidity:	--%RH
Test Voltage:	--	Phase:	L/N
Test Mode:	--		

NOTE: EUT is only power by DC Power, So it is not applicable for this test.







#### 4. RADIATED EMISSION MEASUREMENT

##### 4.1 RADIATED EMISSION LIMITS

In any 100 kHz bandwidth outside the operating frequency band. In case the emission fall within the Restricted band specified on Part15.205(a)&209(a) limit in the table and according to ANSI C63.10-2013 below has to be followed.

LIMITS OF RADIATED EMISSION MEASUREMENT (Frequency Range 9kHz-1000MHz)

Frequencies (MHz)	Field Strength (micorvolts/meter)	Measurement Distance (meters)
0.009~0.490	2400/F(KHz)	300
0.490~1.705	24000/F(KHz)	30
1.705~30.0	30	30
30~88	100	3
88~216	150	3
216~960	200	3
Above 960	500	3

LIMITS OF RADIATED EMISSION MEASUREMENT (Above 1000MHz)

FREQUENCY (MHz)	(dBuV/m) (at 3M)	
	PEAK	AVERAGE
Above 1000	74	54

Notes:

- (1) The limit for radiated test was performed according to FCC PART 15C.
- (2) The tighter limit applies at the band edges.
- (3) Emission level (dBuV/m)=20log Emission level (uV/m).

##### LIMITS OF RESTRICTED FREQUENCY BANDS

FREQUENCY (MHz)	FREQUENCY (MHz)	FREQUENCY (MHz)	FREQUENCY (GHz)
0.090-0.110	16.42-16.423	399.9-410	4.5-5.15
0.495-0.505	16.69475-16.69525	608-614	5.35-5.46
2.1735-2.1905	16.80425-16.80475	960-1240	7.25-7.75
4.125-4.128	25.5-25.67	1300-1427	8.025-8.5
4.17725-4.17775	37.5-38.25	1435-1626.5	9.0-9.2
4.20725-4.20775	73-74.6	1645.5-1646.5	9.3-9.5
6.215-6.218	74.8-75.2	1660-1710	10.6-12.7
6.26775-6.26825	108-121.94	1718.8-1722.2	13.25-13.4
6.31175-6.31225	123-138	2200-2300	14.47-14.5
8.291-8.294	149.9-150.05	2310-2390	15.35-16.2
8.362-8.366	156.52475-156.52525	2483.5-2500	17.7-21.4
8.37625-8.38675	156.7-156.9	2690-2900	22.01-23.12
8.41425-8.41475	162.0125-167.17	3260-3267	23.6-24.0
12.29-12.293	167.72-173.2	3332-3339	31.2-31.8
12.51975-12.52025	240-285	3345.8-3358	36.43-36.5
12.57675-12.57725	322-335.4	3600-4400	Above 38.6
13.36-13.41			



For Radiated Emission

Spectrum Parameter	Setting
Attenuation	Auto
Detector	Peak/QP/AV
Start Frequency	9 KHz/150KHz(Peak/QP/AV)
Stop Frequency	150KHz/30MHz(Peak/QP/AV)
RB / VB (emission in restricted band)	200Hz (From 9kHz to 0.15MHz)/ 9KHz (From 0.15MHz to 30MHz); 200Hz (From 9kHz to 0.15MHz)/ 9KHz (From 0.15MHz to 30MHz)

Spectrum Parameter	Setting
Attenuation	Auto
Detector	Peak/QP
Start Frequency	30 MHz(Peak/QP)
Stop Frequency	1000 MHz (Peak/QP)
RB / VB (emission in restricted band)	120 KHz / 300 KHz

Spectrum Parameter	Setting
Attenuation	Auto
Detector	Peak/AV
Start Frequency	1000 MHz(Peak/AV)
Stop Frequency	10th carrier hamonic(Peak/AV)
RB / VB (emission in restricted band)	1 MHz / 3 MHz(Peak) 1 MHz/1/T MHz(AVG)

For Restricted band

Spectrum Parameter	Setting
Detector	Peak/AV
Start/Stop Frequency	Lower Band Edge: 2310 to 2410 MHz Upper Band Edge: 2475 to 2500 MHz
RB / VB	1 MHz / 3 MHz(Peak) 1 MHz/1/T MHz(AVG)



Receiver Parameter	Setting
Start ~ Stop Frequency	9kHz~90kHz / RB 200Hz for PK & AV
Start ~ Stop Frequency	90kHz~110kHz / RB 200Hz for QP
Start ~ Stop Frequency	110kHz~490kHz / RB 200Hz for PK & AV
Start ~ Stop Frequency	490kHz~30MHz / RB 9kHz for QP
Start ~ Stop Frequency	30MHz~1000MHz / RB 120kHz for QP

#### 4.2 TEST PROCEDURE

- a. The measuring distance at 3 m shall be used for measurements at frequency 0.009MHz up to 1GHz, and above 1GHz.
- b. The EUT was placed on the top of a rotating table 0.8 m (above 1GHz is 1.5 m) above the ground at a 3 m anechoic chamber test site. The table was rotated 360 degree to determine the position of the highest radiation.
- c. The height of the equipment shall be 0.8 m (above 1GHz is 1.5 m); the height of the test antenna shall vary between 1 m to 4 m. Horizontal and vertical polarization of the antenna are set to make the measurement.
- d. The initial step in collecting conducted emission data is a spectrum analyzer peak detector mode pre-scanning the measurement frequency range. Significant peaks are then marked and QuasiPeak detector mode will be re-measured.
- e. If the Peak Mode measured value is compliance with and lower than Quasi Peak Mode Limit, the EUT shall be deemed to meet QP Limits and no additional QP Mode measurement was performed.
- f. For the actual test configuration, please refer to the related Item –EUT Test Photos.

Note:

Both horizontal and vertical antenna polarities were tested and performed pretest to three orthogonal axis. The worst case emissions were reported.

### 4.3 TEST SETUP

#### (A) Radiated Emission Test-Up Frequency Below 30MHz

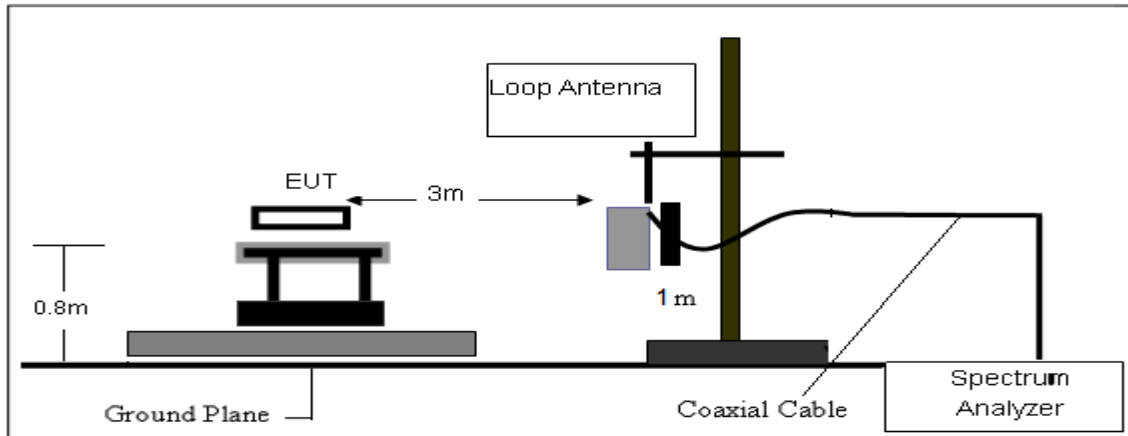

#### (B) Radiated Emission Test-Up Frequency 30MHz~1GHz

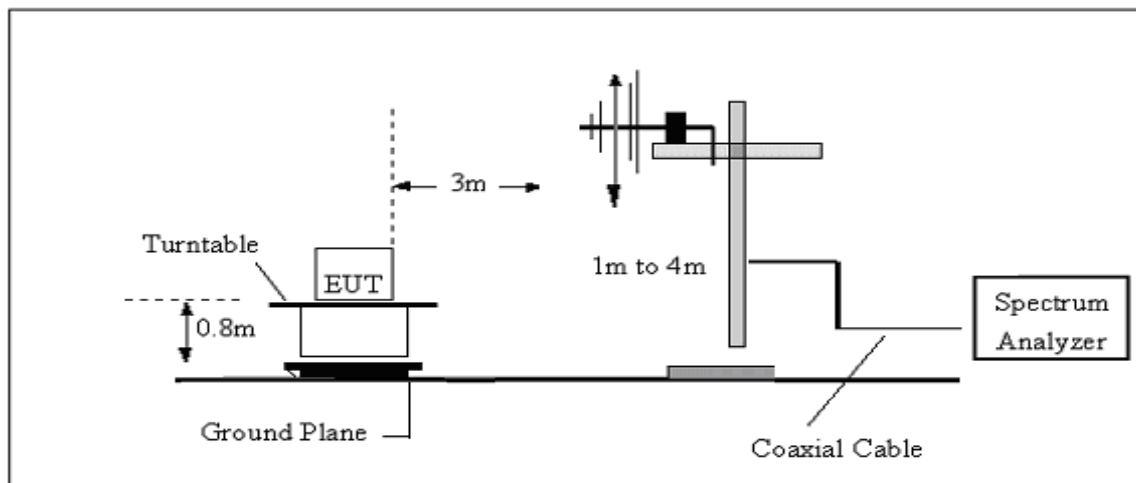

#### (C) Radiated Emission Test-Up Frequency Above 1GHz

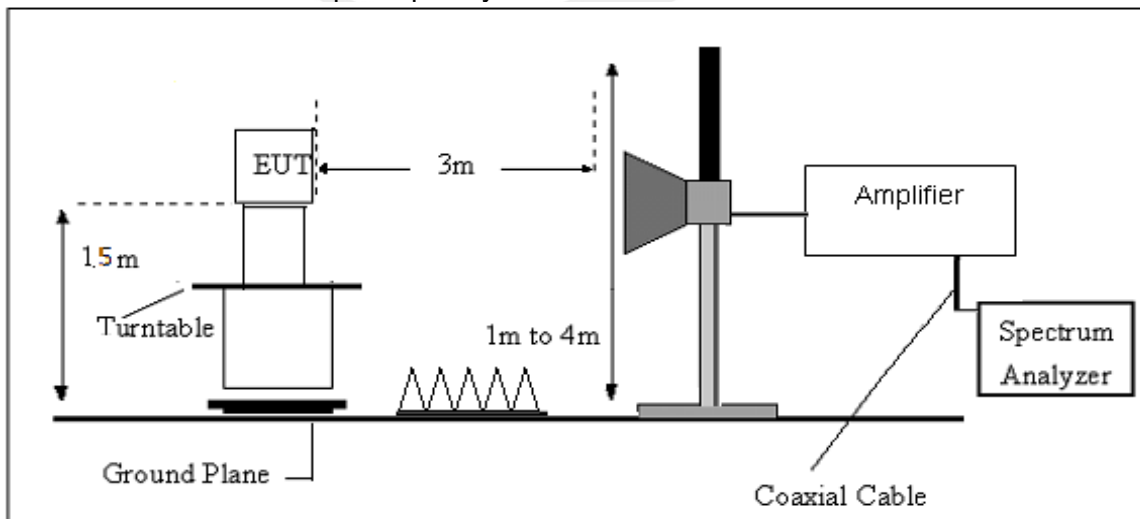

### 4.4 EUT OPERATING CONDITIONS

Please refer to section 3.4 of this report.

### 4.5 FIELD STRENGTH CALCULATION



The field strength is calculated by adding the Antenna Factor and Cable Factor and subtracting the Amplifier Gain and Duty Cycle Correction Factor (if any) from the measured reading. The basic equation with a sample calculation is as follows:

$$FS = RA + AF + CL - AG$$

Where

FS = Field Strength

CL = Cable Attenuation Factor (Cable Loss)

RA = Reading Amplitude

AG = Amplifier Gain

AF = Antenna Factor

For example

Frequency (MHz)	FS (dB $\mu$ V/m)	RA (dB $\mu$ V/m)	AF (dB)	CL (dB)	AG (dB)	Factor (dB)
300	40	58.1	12.2	1.6	31.9	-18.1

$$\text{Factor} = \text{AF} + \text{CL} - \text{AG}$$





#### 4.6 TEST RESULTS

(Between 9KHz – 30 MHz)

Temperature:	23.1(C)	Relative Humidity:	60%RH
Test Voltage:	DC 12V	Polarization:	--
Test Mode:	TX Mode		

Freq. (MHz)	Reading (dBuV/m)	Limit (dBuV/m)	Margin (dB)	State P/F
--	--	--	--	PASS
--	--	--	--	PASS

**Note:**

The amplitude of spurious emissions which are attenuated by more than 20dB below the permissible value has no need to be reported.

Distance extrapolation factor =  $40 \log(\text{specific distance}/\text{test distance})(\text{dB})$ ;

Limit line = specific limits(dBuV) + distance extrapolation factor.

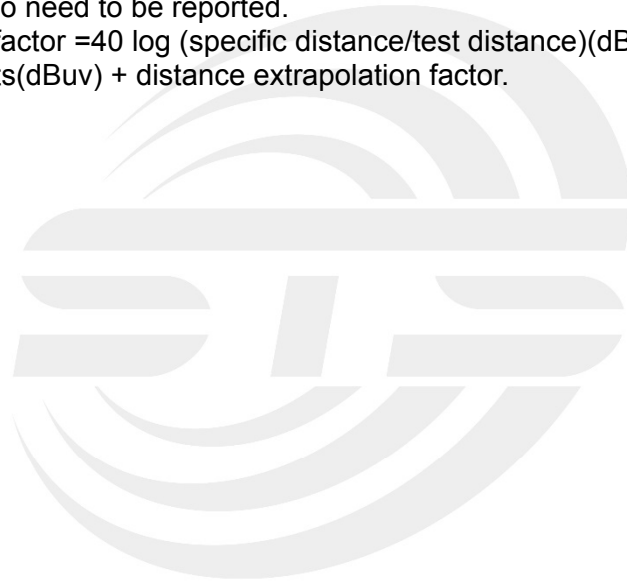



(30MHz -1000MHz)

Temperature:	23.1(C)	Relative Humidity:	60%RH
Test Voltage:	DC 12V	Phase:	Horizontal
Test Mode:	Mode 1/2/3 (Mode 3 worst mode)		

No.	Frequency (MHz)	Reading (dBuV)	Correct Factor(dB/m)	Result (dBuV/m)	Limit (dBuV/m)	Margin (dB)	Remark
1	44.5500	47.38	-20.43	26.95	40.00	-13.05	peak
2	167.7400	46.93	-19.58	27.35	43.50	-16.15	peak
3	484.9300	32.44	-8.44	24.00	46.00	-22.00	peak
4	741.9800	30.93	-2.12	28.81	46.00	-17.19	peak
5	837.0400	31.48	-0.46	31.02	46.00	-14.98	peak
6	980.6000	31.69	2.63	34.32	54.00	-19.68	peak

Remark:

- Margin = Result (Result =Reading + Factor )-Limit
- Factor= Antenna factor+Cable attenuation factor(cable loss)-Amplifier gain

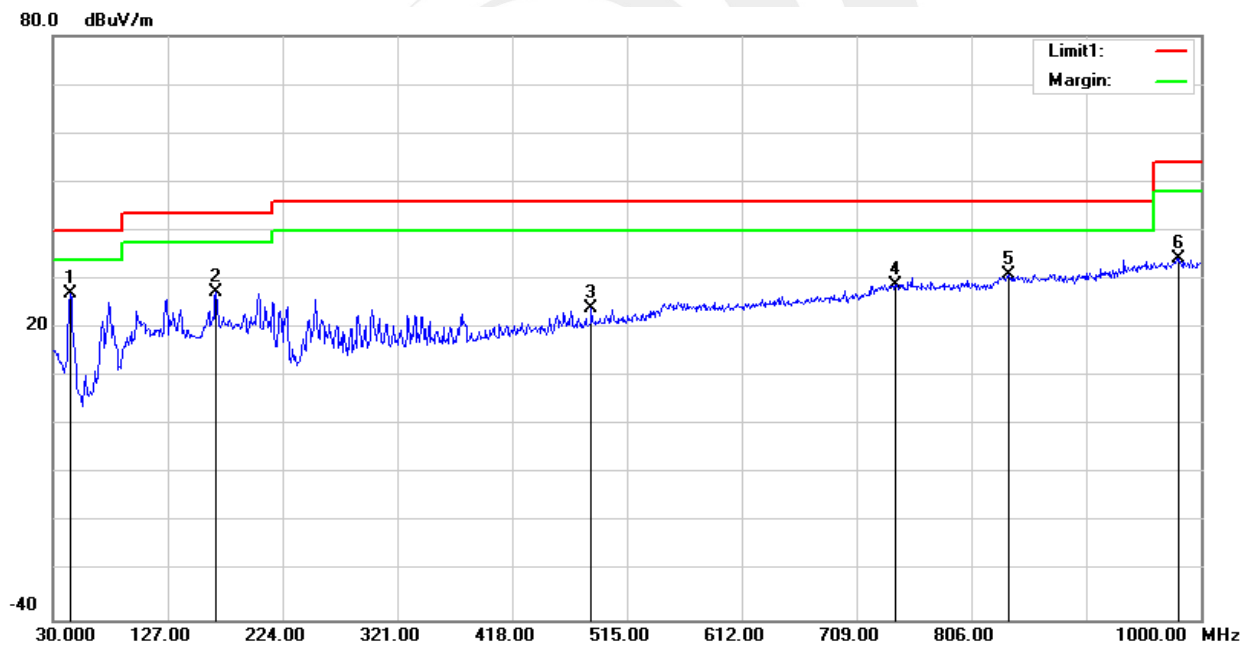



Temperature:	23.1(C)	Relative Humidity:	60%RH
Test Voltage:	DC 12V	Phase:	Vertical
Test Mode:	Mode 1/2/3 (Mode 3 worst mode)		

No.	Frequency (MHz)	Reading (dBUV)	Correct Factor(dB/m)	Result (dBUV/m)	Limit (dBUV/m)	Margin (dB)	Remark
1	44.5500	52.18	-20.43	31.75	40.00	-8.25	peak
2	125.0600	49.45	-18.22	31.23	43.50	-12.27	peak
3	450.0100	32.32	-9.67	22.65	46.00	-23.35	peak
4	745.8600	31.82	-2.14	29.68	46.00	-16.32	peak
5	841.8900	32.17	-0.42	31.75	46.00	-14.25	peak
6	984.4800	32.04	2.40	34.44	54.00	-19.56	peak

Remark:

- Margin = Result (Result =Reading + Factor)–Limit
- Factor= Antenna factor+Cable attenuation factor(cable loss)-Amplifier gain

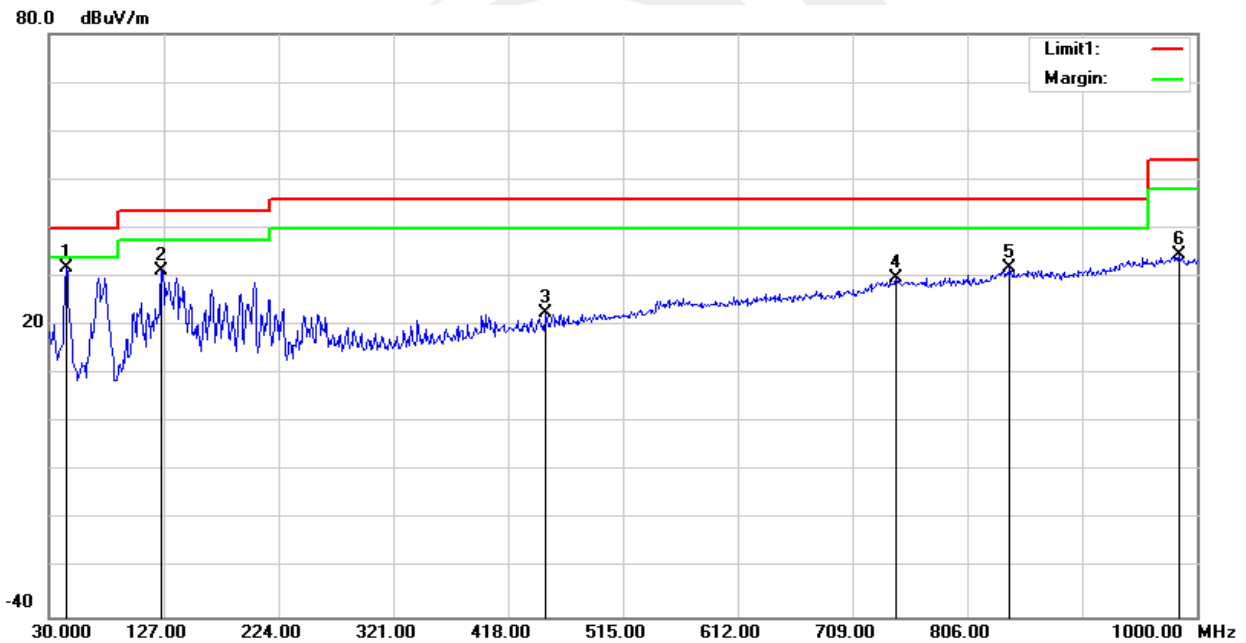





(1GHz-25GHz) Spurious emission Requirements

GFSK

Frequency (MHz)	Meter Reading (dBμV)	Amplifier (dB)	Loss (dB)	Antenna Factor (dB/m)	Corrected Factor (dB)	Emission Level (dBμV/m)	Limits (dBμV/m)	Margin (dB)	Detector Type	Comment
Low Channel (GFSK/2402 MHz)										
3264.75	61.63	44.70	6.70	28.20	-9.80	51.83	74.00	-22.17	PK	Vertical
3264.75	50.09	44.70	6.70	28.20	-9.80	40.29	54.00	-13.71	AV	Vertical
3264.71	61.64	44.70	6.70	28.20	-9.80	51.84	74.00	-22.16	PK	Horizontal
3264.71	51.11	44.70	6.70	28.20	-9.80	41.31	54.00	-12.69	AV	Horizontal
4804.49	58.89	44.20	9.04	31.60	-3.56	55.33	74.00	-18.67	PK	Vertical
4804.49	49.59	44.20	9.04	31.60	-3.56	46.03	54.00	-7.97	AV	Vertical
4804.50	58.32	44.20	9.04	31.60	-3.56	54.76	74.00	-19.24	PK	Horizontal
4804.50	49.59	44.20	9.04	31.60	-3.56	46.03	54.00	-7.97	AV	Horizontal
5359.64	48.80	44.20	9.86	32.00	-2.34	46.46	74.00	-27.54	PK	Vertical
5359.64	39.58	44.20	9.86	32.00	-2.34	37.24	54.00	-16.76	AV	Vertical
5359.82	47.23	44.20	9.86	32.00	-2.34	44.88	74.00	-29.12	PK	Horizontal
5359.82	38.30	44.20	9.86	32.00	-2.34	35.96	54.00	-18.04	AV	Horizontal
7205.83	53.62	43.50	11.40	35.50	3.40	57.02	74.00	-16.98	PK	Vertical
7205.83	44.61	43.50	11.40	35.50	3.40	48.01	54.00	-5.99	AV	Vertical
7205.95	53.99	43.50	11.40	35.50	3.40	57.39	74.00	-16.61	PK	Horizontal
7205.95	44.93	43.50	11.40	35.50	3.40	48.33	54.00	-5.67	AV	Horizontal
Middle Channel (GFSK/2440 MHz)										
3262.97	61.78	44.70	6.70	28.20	-9.80	51.98	74.00	-22.02	PK	Vertical
3262.97	50.98	44.70	6.70	28.20	-9.80	41.18	54.00	-12.82	AV	Vertical
3262.98	62.10	44.70	6.70	28.20	-9.80	52.30	74.00	-21.70	PK	Horizontal
3262.98	51.22	44.70	6.70	28.20	-9.80	41.42	54.00	-12.58	AV	Horizontal
4879.85	59.26	44.20	9.04	31.60	-3.56	55.70	74.00	-18.30	PK	Vertical
4879.85	49.36	44.20	9.04	31.60	-3.56	45.80	54.00	-8.20	AV	Vertical
4880.10	58.89	44.20	9.04	31.60	-3.56	55.33	74.00	-18.67	PK	Horizontal
4880.10	49.44	44.20	9.04	31.60	-3.56	45.88	54.00	-8.12	AV	Horizontal
5357.13	48.60	44.20	9.86	32.00	-2.34	46.25	74.00	-27.75	PK	Vertical
5357.13	40.36	44.20	9.86	32.00	-2.34	38.02	54.00	-15.98	AV	Vertical
5357.39	47.47	44.20	9.86	32.00	-2.34	45.13	74.00	-28.87	PK	Horizontal
5357.03	38.72	44.20	9.86	32.00	-2.34	36.38	54.00	-17.62	AV	Horizontal
7320.85	53.58	43.50	11.40	35.50	3.40	56.98	74.00	-17.02	PK	Vertical
7320.85	44.27	43.50	11.40	35.50	3.40	47.67	54.00	-6.33	AV	Vertical
7320.29	54.90	43.50	11.40	35.50	3.40	58.30	74.00	-15.70	PK	Horizontal
7320.29	43.83	43.50	11.40	35.50	3.40	47.23	54.00	-6.77	AV	Horizontal



High Channel (GFSK/2480 MHz)										
3264.83	61.53	44.70	6.70	28.20	-9.80	51.73	74.00	-22.27	PK	Vertical
3264.83	50.69	44.70	6.70	28.20	-9.80	40.89	54.00	-13.11	AV	Vertical
3264.72	61.14	44.70	6.70	28.20	-9.80	51.34	74.00	-22.66	PK	Horizontal
3264.72	50.59	44.70	6.70	28.20	-9.80	40.79	54.00	-13.21	AV	Horizontal
4960.29	59.47	44.20	9.04	31.60	-3.56	55.91	74.00	-18.09	PK	Vertical
4960.29	50.32	44.20	9.04	31.60	-3.56	46.76	54.00	-7.24	AV	Vertical
4960.56	59.37	44.20	9.04	31.60	-3.56	55.81	74.00	-18.19	PK	Horizontal
4960.56	49.91	44.20	9.04	31.60	-3.56	46.35	54.00	-7.65	AV	Horizontal
5359.65	49.36	44.20	9.86	32.00	-2.34	47.02	74.00	-26.98	PK	Vertical
5359.65	39.05	44.20	9.86	32.00	-2.34	36.71	54.00	-17.29	AV	Vertical
5359.71	48.30	44.20	9.86	32.00	-2.34	45.96	74.00	-28.04	PK	Horizontal
5359.71	38.31	44.20	9.86	32.00	-2.34	35.97	54.00	-18.03	AV	Horizontal
7439.92	53.55	43.50	11.40	35.50	3.40	56.95	74.00	-17.05	PK	Vertical
7439.92	44.82	43.50	11.40	35.50	3.40	48.22	54.00	-5.78	AV	Vertical
7439.85	54.26	43.50	11.40	35.50	3.40	57.66	74.00	-16.34	PK	Horizontal
7439.85	44.98	43.50	11.40	35.50	3.40	48.38	54.00	-5.62	AV	Horizontal

Note:

1) Factor = Antenna Factor + Cable Loss – Pre-amplifier.

Emission Level = Reading + Factor

2) The frequency emission of peak points that did not show above the forms are at least 20dB below the limit, the frequency emission is mainly from the environment noise.



4.6 TEST RESULTS (Restricted Bands Requirements)

**GFSK-Low**  
Horizontal

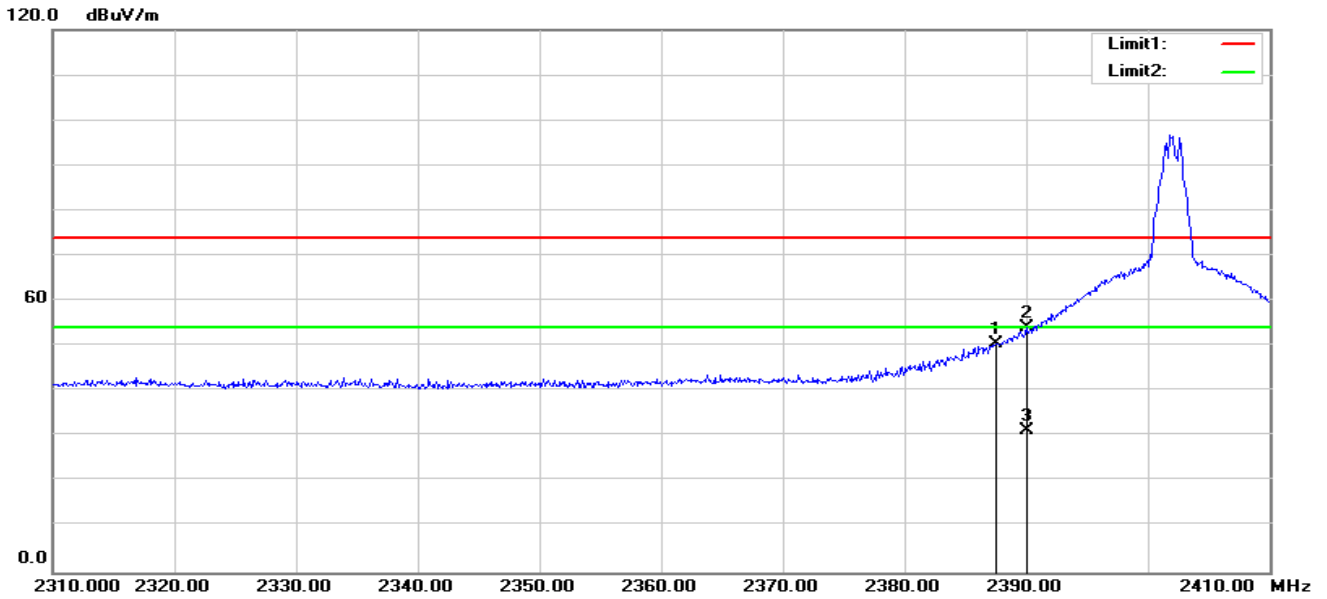

No.	Frequency (MHz)	Reading (dBuV)	Correct Factor(dB/m)	Result (dBuV/m)	Limit (dBuV/m)	Margin (dB)	Remark
1	2387.500	46.34	4.31	50.65	74.00	-23.35	peak
2	2390.000	49.91	4.34	54.25	74.00	-19.75	peak
3	2390.000	26.91	4.34	31.25	54.00	-22.75	AVG

Vertical

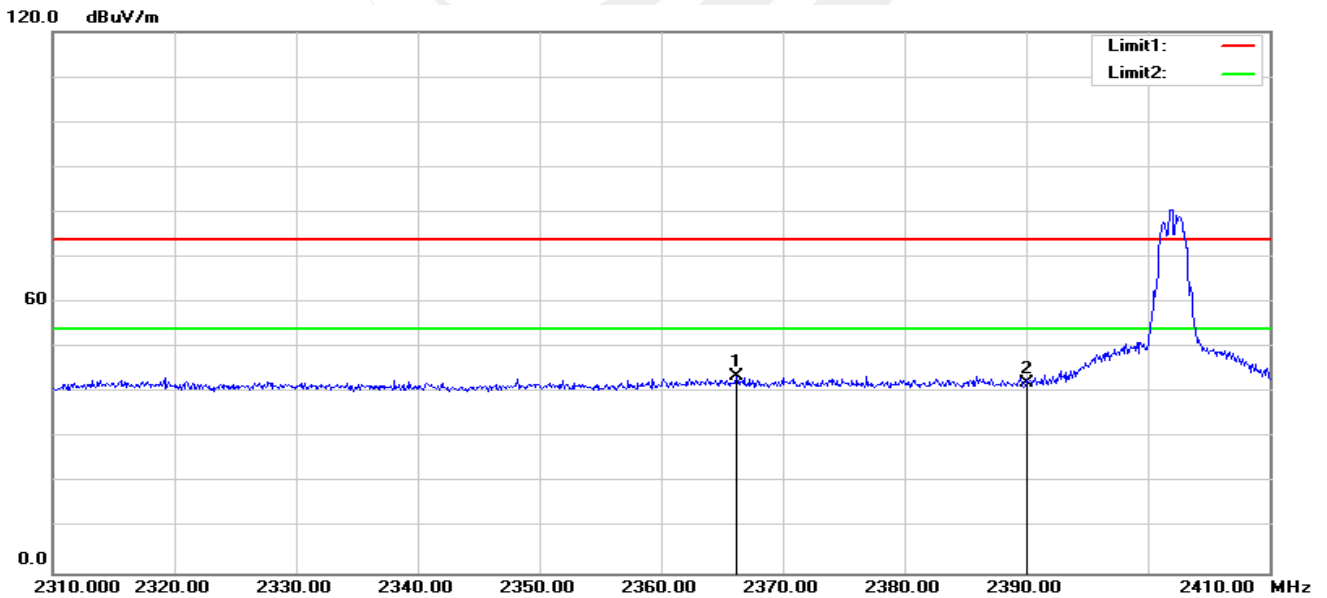

No.	Frequency (MHz)	Reading (dBuV)	Correct Factor(dB/m)	Result (dBuV/m)	Limit (dBuV/m)	Margin (dB)	Remark
1	2366.200	39.69	3.99	43.68	74.00	-30.32	peak
2	2390.000	37.81	4.34	42.15	74.00	-31.85	peak



**GFSK-High**  
Horizontal

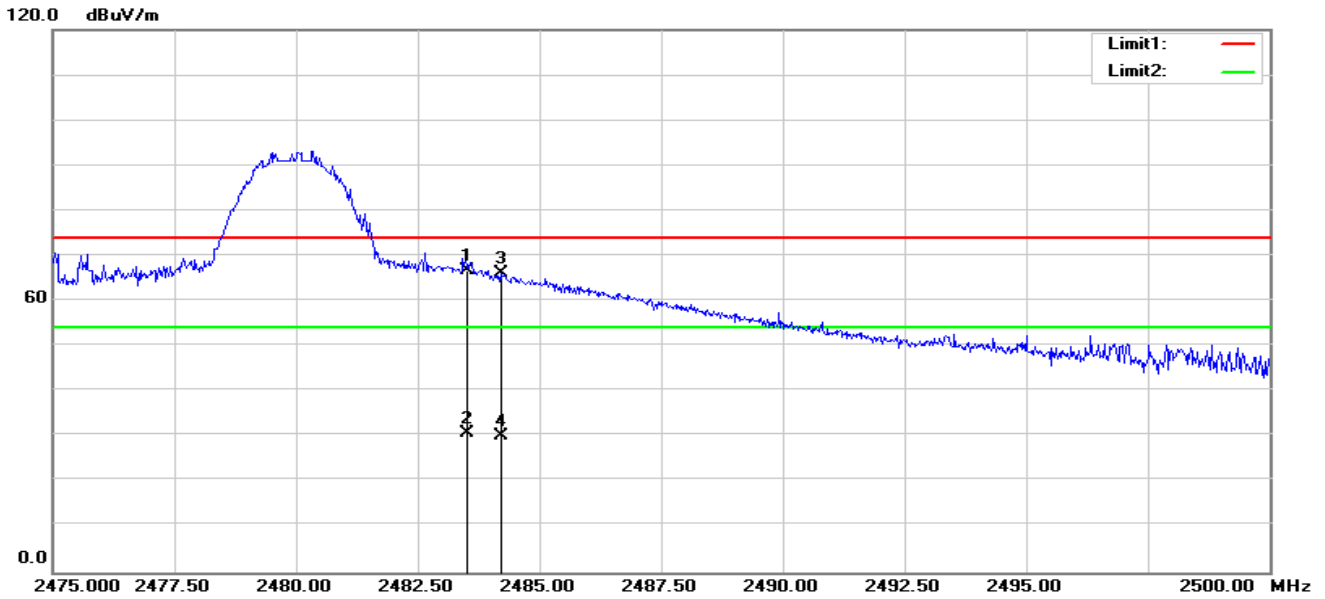

No.	Frequency (MHz)	Reading (dBuV)	Correct Factor(dB/m)	Result (dBuV/m)	Limit (dBuV/m)	Margin (dB)	Remark
1	2483.500	62.03	4.60	66.63	74.00	-7.37	peak
2	2483.500	26.16	4.60	30.76	54.00	-23.24	AVG
3	2484.200	61.45	4.61	66.06	74.00	-7.94	peak
4	2484.200	25.68	4.61	30.29	54.00	-23.71	AVG

Vertical

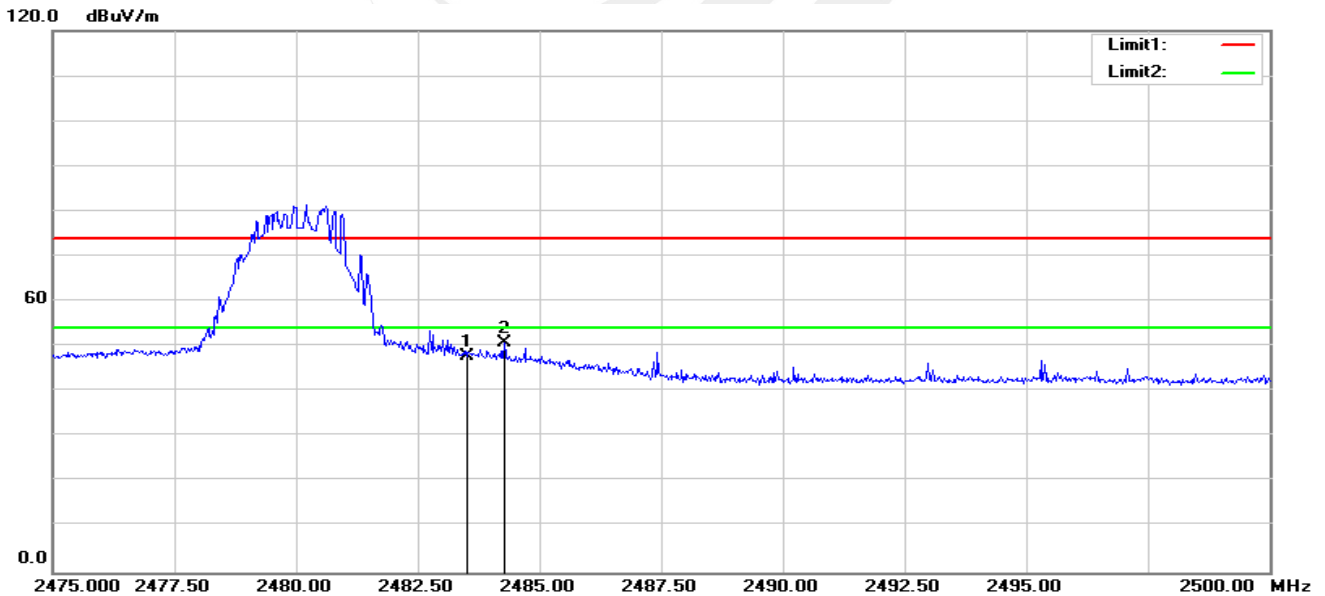

No.	Frequency (MHz)	Reading (dBuV)	Correct Factor(dB/m)	Result (dBuV/m)	Limit (dBuV/m)	Margin (dB)	Remark
1	2483.500	43.32	4.60	47.92	74.00	-26.08	peak
2	2484.275	46.24	4.61	50.85	74.00	-23.15	peak

## 5. CONDUCTED SPURIOUS & BAND EDGE EMISSION

### 5.1 LIMIT

According to FCC section 15.247(d), in any 100kHz bandwidth outside the frequency band in which the spread spectrum or digitally modulated intentional radiator is operating, the radio frequency power that is produced by the intentional radiator shall be at least 20dB below that in the 100kHz bandwidth within the band that contains the highest level of the desired power, based on either an RF conducted or a radiated measurement.

### 5.2 TEST PROCEDURE

Spectrum Parameter	Setting
Detector	Peak
Start/Stop Frequency	30 MHz to 10th carrier harmonic
RB / VB (emission in restricted band)	100 KHz/300 KHz
Trace-Mode:	Max hold

For Band edge

Spectrum Parameter	Setting
Detector	Peak
Start/Stop Frequency	Lower Band Edge: 2300 – 2407 MHz Upper Band Edge: 2475 – 2500 MHz
RB / VB (emission in restricted band)	100 KHz/300 KHz
Trace-Mode:	Max hold

### 5.3 TEST SETUP



The EUT is connected to the Spectrum Analyzer; the RF load attached to the EUT antenna terminals is 50 Ohm; the path loss as the factor is calibrated to correct the reading. Make the measurement with the spectrum analyzer's resolution bandwidth(RBW) = 100 kHz. In order to make an accurate measurement, set the span greater than RBW.

### 5.4 EUT OPERATION CONDITIONS

Please refer to section 3.4 of this report.

### 5.5 TEST RESULTS

Note: The test data please refer to APPENDIX 1.

## 6. POWER SPECTRAL DENSITY TEST

### 6.1 LIMIT

FCC Part 15.247, Subpart C				
Section	Test Item	Limit	Frequency Range (MHz)	Result
15.247(e)	Power Spectral Density	$\leq 8$ dBm (RBW $\geq 3$ KHz)	2400-2483.5	PASS

### 6.2 TEST PROCEDURE

1. Set analyzer center frequency to DTS channel center frequency.
2. Set the span to 1.5 times the DTS channel bandwidth.
3. Set the RBW to:  $100 \text{ kHz} \geq \text{RBW} \geq 3 \text{ kHz}$ .
4. Set the VBW  $\geq 3 \times \text{RBW}$ .
5. Detector = peak.
6. Sweep time = auto couple.
7. Trace mode = max hold.
8. Allow trace to fully stabilize.
9. Use the peak marker function to determine the maximum amplitude level.
10. If measured value exceeds limit, reduce RBW (no less than 3 kHz) and repeat.

### 6.3 TEST SETUP



### 6.4 EUT OPERATION CONDITIONS

Please refer to section 3.4 of this report.

### 6.5 TEST RESULTS

Note: The test data please refer to APPENDIX 1.

## 7. BANDWIDTH TEST

### 7.1 LIMIT

FCC Part 15.247,Subpart C				
Section	Test Item	Limit	Frequency Range (MHz)	Result
15.247(a)(2)	Bandwidth	$\geq 500\text{KHz}$ (6dB bandwidth)	2400-2483.5	PASS

### 7.2 TEST PROCEDURE

The automatic bandwidth measurement capability of an instrument may be employed using the X dB bandwidth mode with X set to 6 dB, if the functionality described above (i.e., RBW = 100 kHz, VBW $\geq$ 3RBW, peak detector with maximum hold) is implemented by the instrumentation function. When using this capability, care shall be taken so that the bandwidth measurement is not influenced by any intermediate power nulls in the fundamental emission that might be  $\geq 6$  dB.

### 7.3 TEST SETUP



### 7.4 EUT OPERATION CONDITIONS

Please refer to section 3.4 of this report.

### 7.5 TEST RESULTS

Note: The test data please refer to APPENDIX 1.



## 8. PEAK OUTPUT POWER TEST

### 8.1 LIMIT

FCC Part 15.247, Subpart C				
Section	Test Item	Limit	Frequency Range (MHz)	Result
15.247(b)(3)	Output Power	1 watt or 30dBm	2400-2483.5	PASS

### 8.2 TEST PROCEDURE

One of the following procedures may be used to determine the maximum peak conducted output power of a DTS EUT.

RBW  $\geq$  DTS bandwidth

The following procedure shall be used when an instrument with a resolution bandwidth that is greater than the DTS bandwidth is available to perform the measurement:

- Set the RBW  $\geq$  DTS bandwidth.
- Set VBW  $\geq$  [3  $\times$  RBW].
- Set span  $\geq$  [3  $\times$  RBW].
- Sweep time = auto couple.
- Detector = peak.
- Trace mode = max hold.
- Allow trace to fully stabilize.
- Use peak marker function to determine the peak amplitude level.

Integrated band power method:

The following procedure can be used when the maximum available RBW of the instrument is less than the

DTS bandwidth:

- Set the RBW = 1 MHz.
- Set the VBW  $\geq$  [3  $\times$  RBW].
- Set the span  $\geq$  [1.5  $\times$  DTS bandwidth].
- Detector = peak.
- Sweep time = auto couple.
- Trace mode = max hold.
- Allow trace to fully stabilize.
- Use the instrument's band/channel power measurement function with the band limits set equal to the DTS bandwidth edges (for some instruments, this may require a manual override to select the peak detector). If the instrument does not have a band power function, then sum the spectrum levels (in linear power units) at intervals equal to the RBW extending across the DTS channel bandwidth.

PKPM1 Peak power meter method:

The maximum peak conducted output power may be measured using a broadband peak RF power meter. The power meter shall have a video bandwidth that is greater than or equal to the DTS bandwidth and shall use a fast-responding diode detector.



### 8.3 TEST SETUP

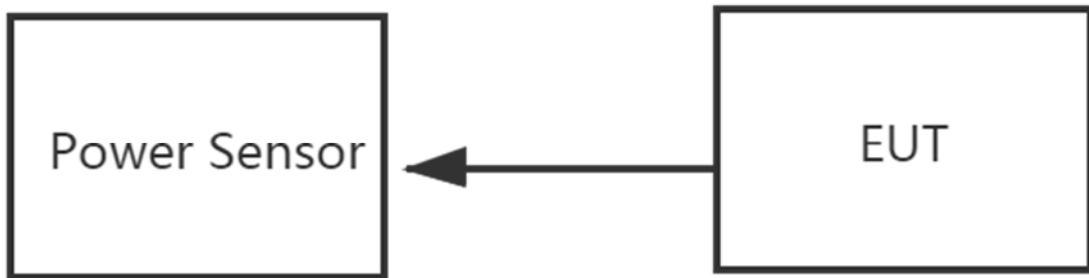

### 8.4 EUT OPERATION CONDITIONS

Please refer to section 3.4 of this report.

### 8.5 TEST RESULTS

Note: The test data please refer to APPENDIX 1.

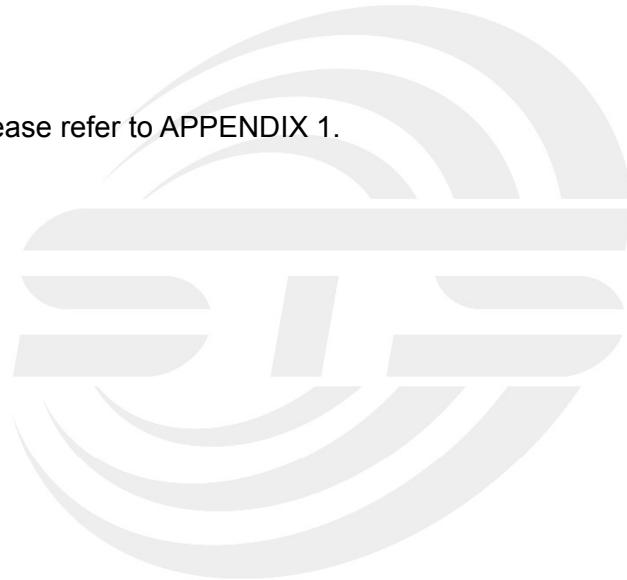



## 9. ANTENNA REQUIREMENT

### 9.1 STANDARD REQUIREMENT

15.203 requirement: For intentional device, according to 15.203: an intentional radiator shall be designed to ensure that no antenna other than that furnished by the responsible party shall be used with the device.

### 9.2 EUT ANTENNA

The EUT antenna is PCB Antenna. It comply with the standard requirement.





## APPENDIX 1-TEST DATA

## 1. DUTY CYCLE

Condition	Mode	Frequency (MHz)	Duty Cycle (%)	Correction Factor (dB)	1/T (kHz)
NVNT	BLE 1M	2402	60.29	2.2	2.65
NVNT	BLE 1M	2440	60.3	2.2	2.65
NVNT	BLE 1M	2480	60.38	2.19	2.65





Test Graphs

Duty Cycle NVNT BLE 1M 2402MHz

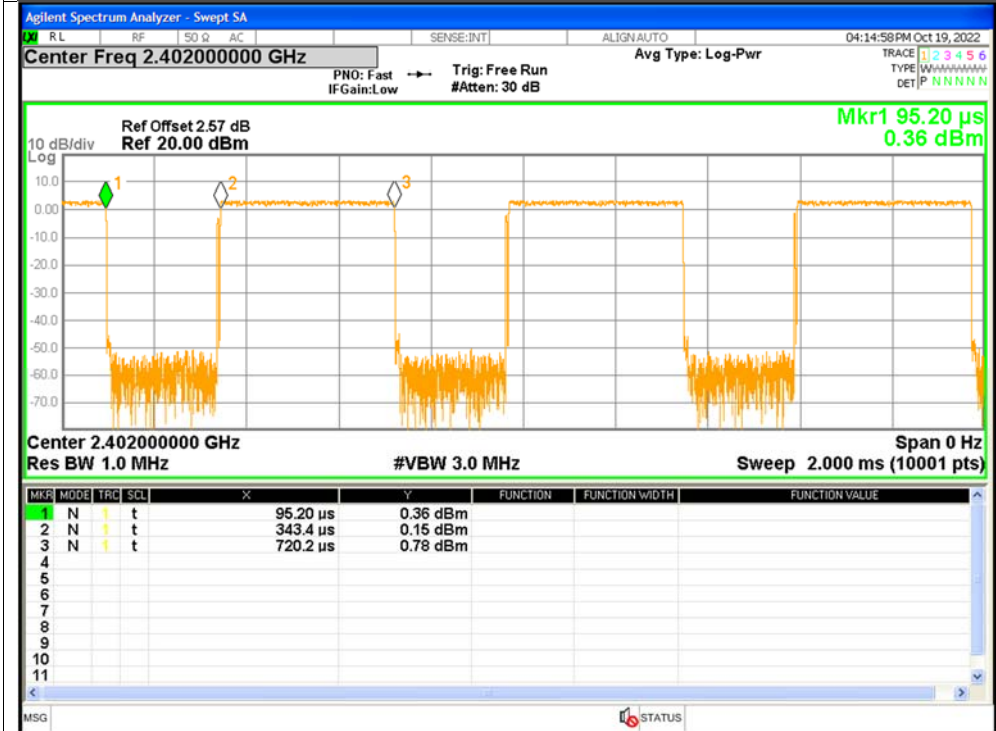

Duty Cycle NVNT BLE 1M 2440MHz

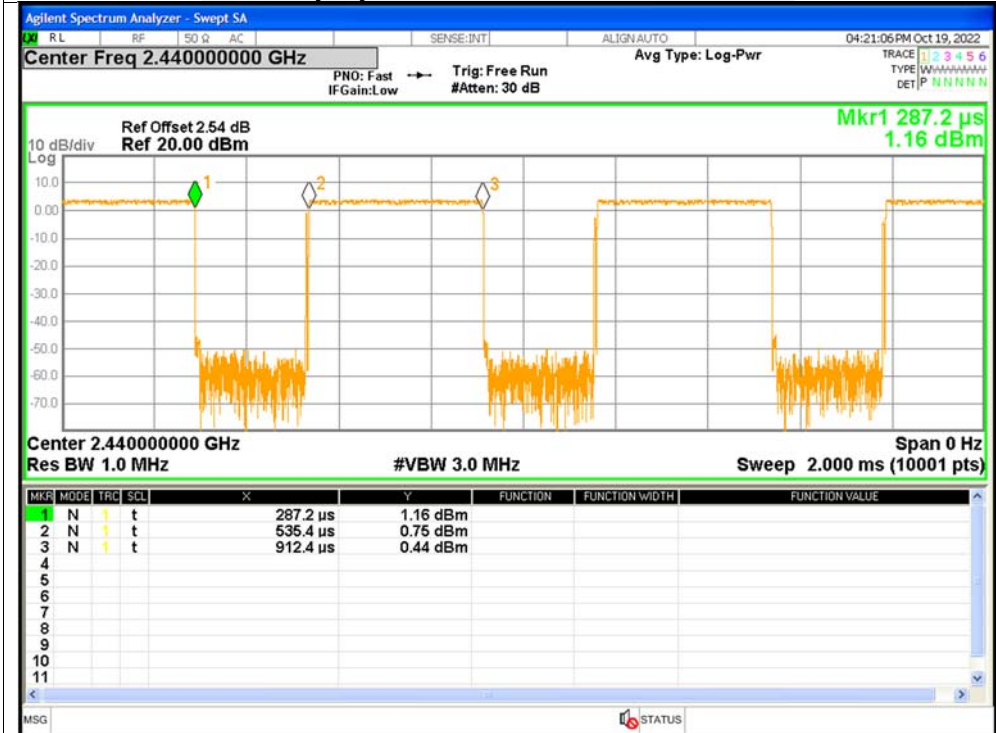

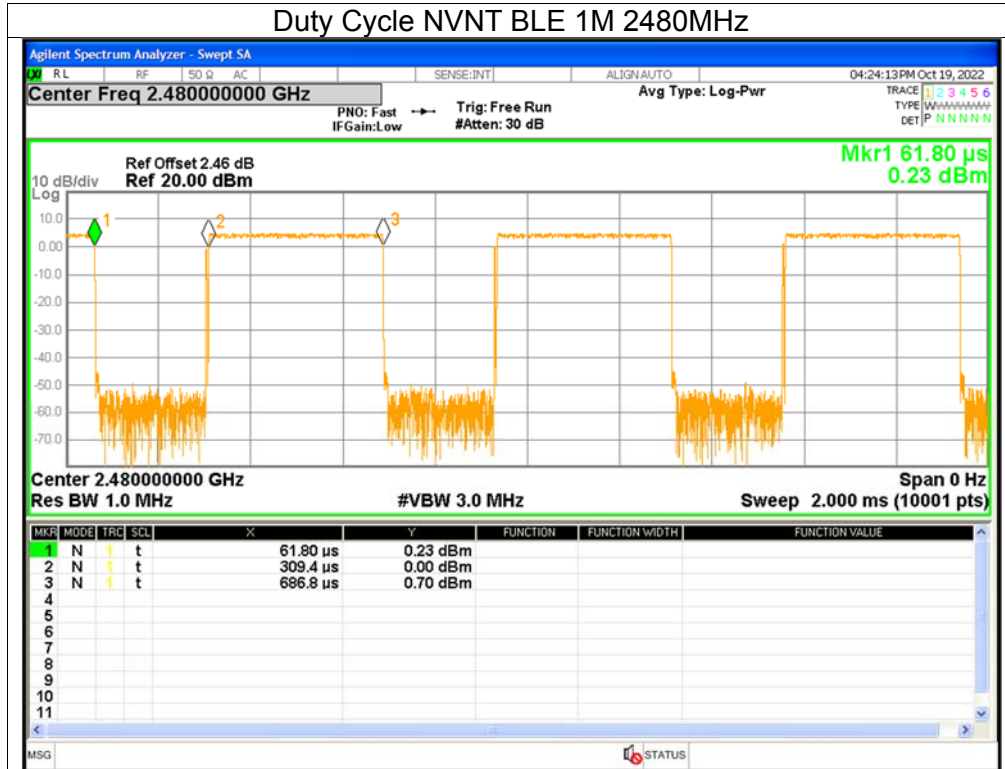



## 2. MAXIMUM AVERAGE CONDUCTED OUTPUT POWER

Condition	Mode	Frequency (MHz)	Conducted Power (dBm)	Duty Factor (dB)	Total Power (dBm)	Limit (dBm)	Verdict
NVNT	BLE 1M	2402	-2.86	2.2	-0.66	<=30	Pass
NVNT	BLE 1M	2440	-2.01	2.2	0.19	<=30	Pass
NVNT	BLE 1M	2480	-1.22	2.19	0.97	<=30	Pass





### Test Graphs

#### Average Power NVNT BLE 1M 2402MHz

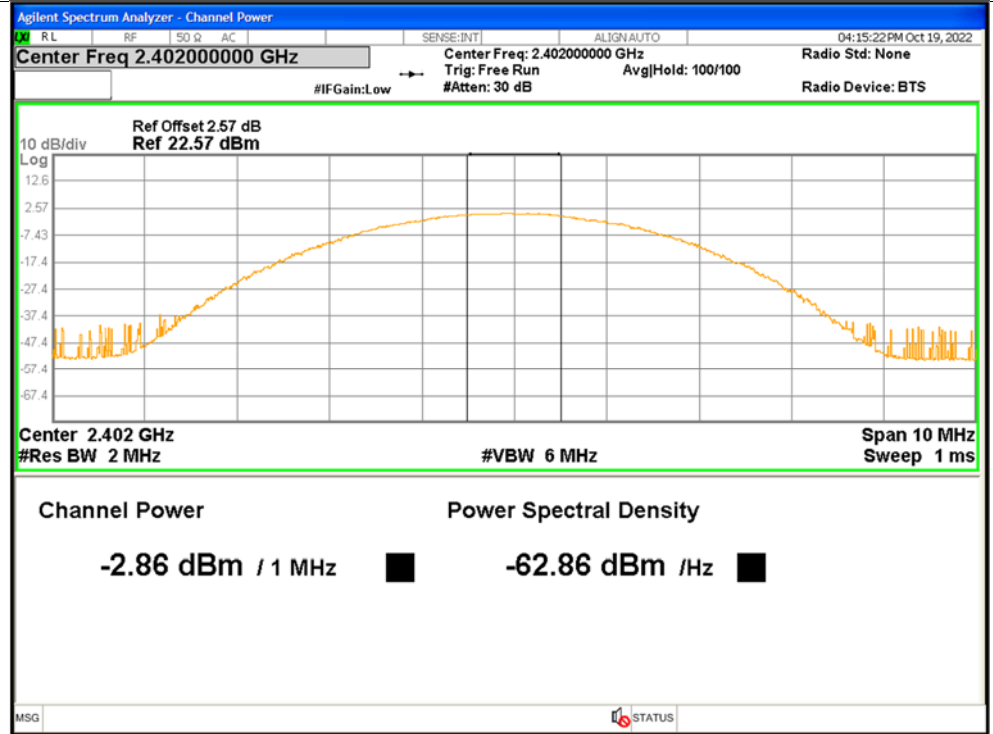

#### Average Power NVNT BLE 1M 2440MHz

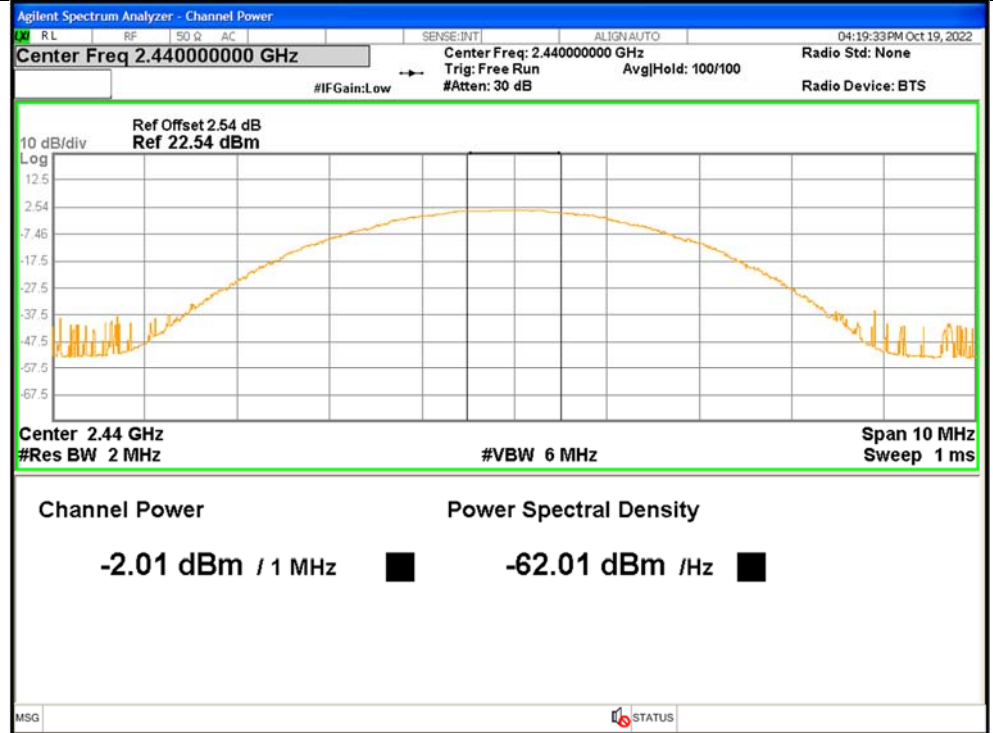

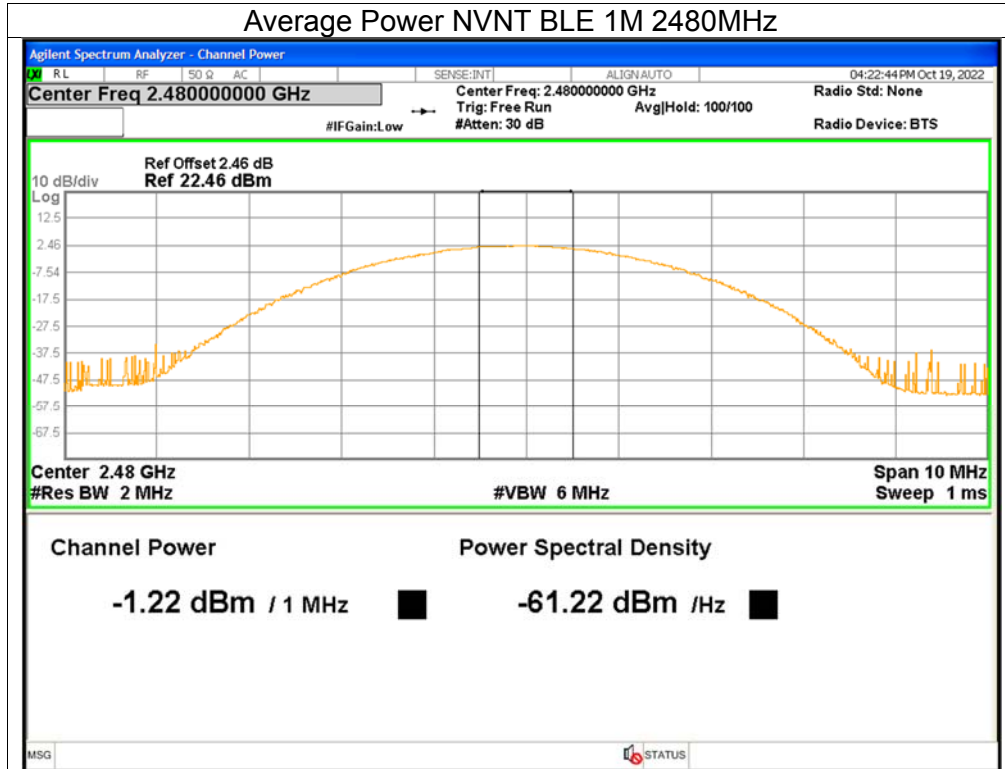





## 3. MAXIMUM PEAK CONDUCTED OUTPUT POWER

Condition	Mode	Frequency (MHz)	Conducted Power (dBm)	Limit (dBm)	Verdict
NVNT	BLE 1M	2402	3.37	<=30	Pass
NVNT	BLE 1M	2440	4.07	<=30	Pass
NVNT	BLE 1M	2480	5.01	<=30	Pass





### Test Graphs

#### Peak Power NVNT BLE 1M 2402MHz

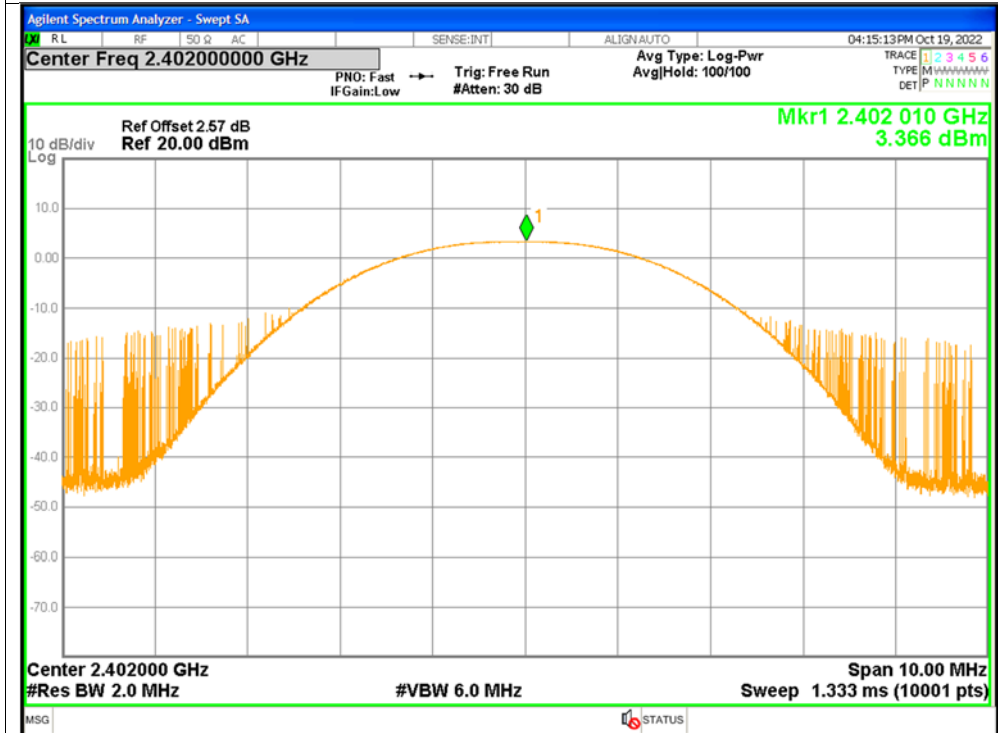

#### Peak Power NVNT BLE 1M 2440MHz

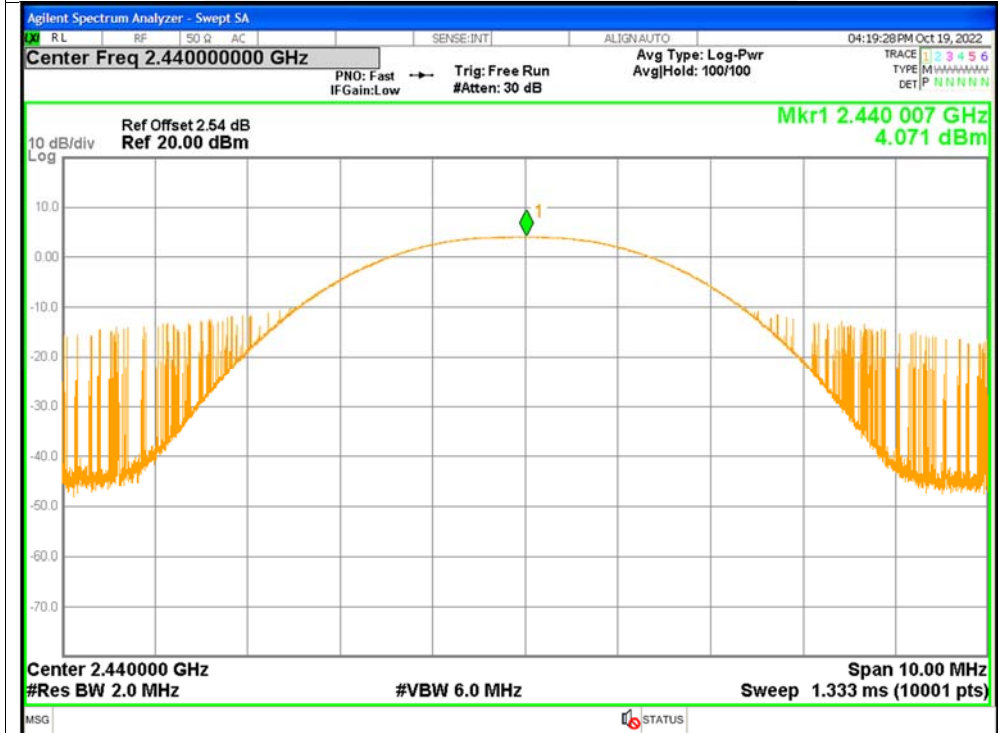

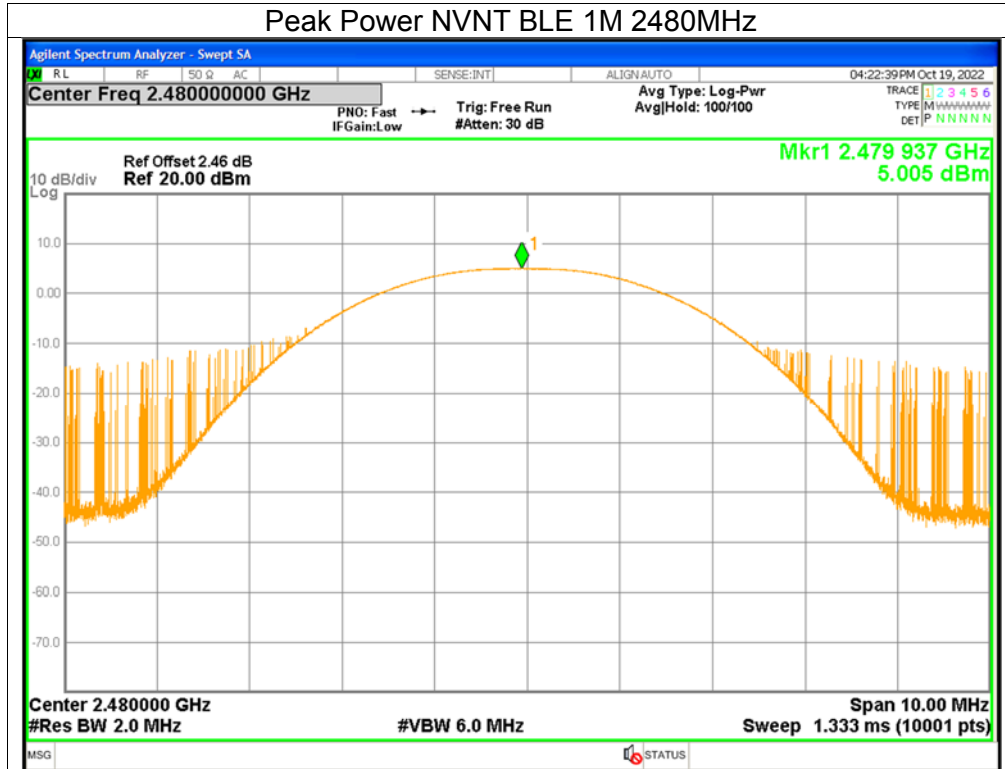



## 4. -6DB BANDWIDTH

Condition	Mode	Frequency (MHz)	-6 dB Bandwidth (MHz)	Limit -6 dB Bandwidth (MHz)	Verdict
NVNT	BLE 1M	2402	0.73	$\geq 0.5$	Pass
NVNT	BLE 1M	2440	0.72	$\geq 0.5$	Pass
NVNT	BLE 1M	2480	0.69	$\geq 0.5$	Pass





Test Graphs

-6dB Bandwidth NVNT BLE 1M 2402MHz

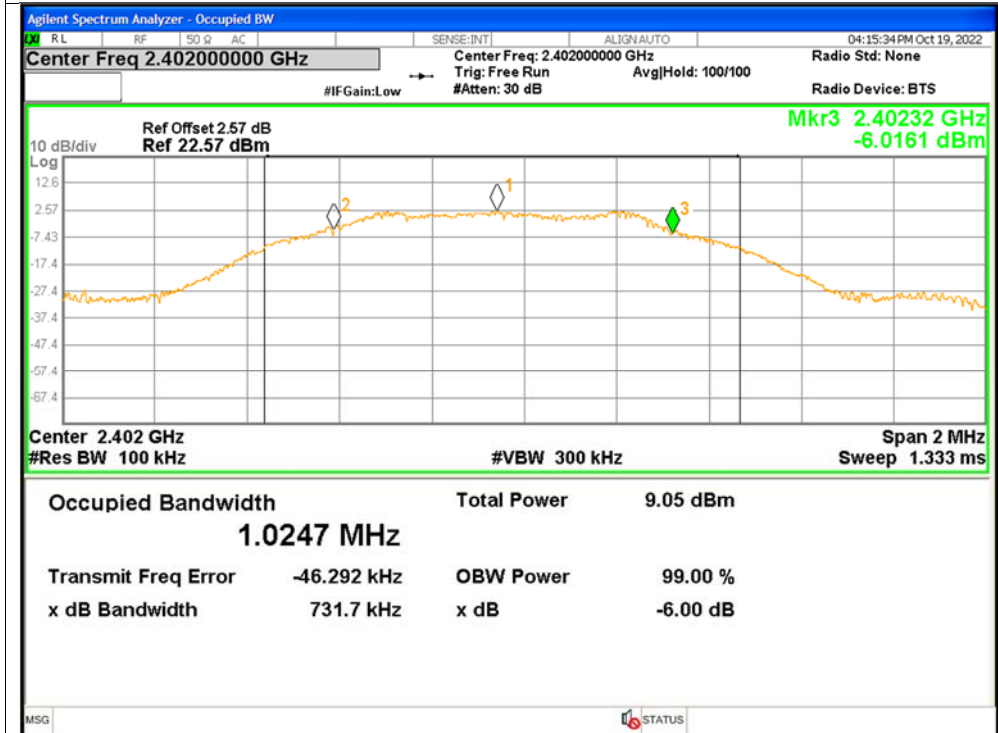

-6dB Bandwidth NVNT BLE 1M 2440MHz

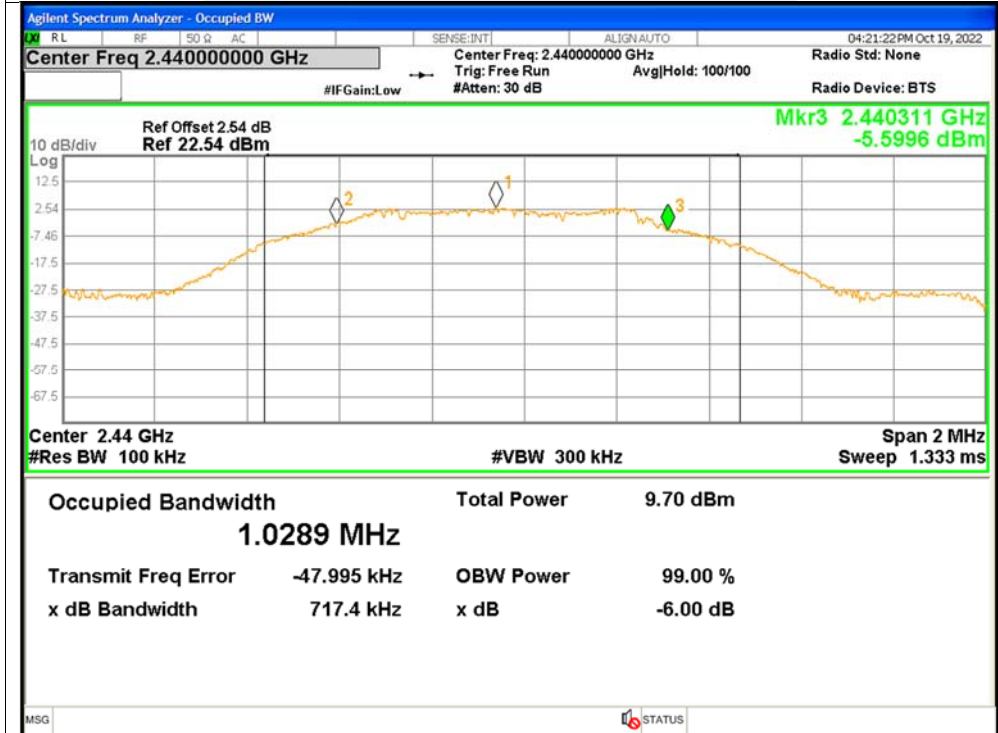

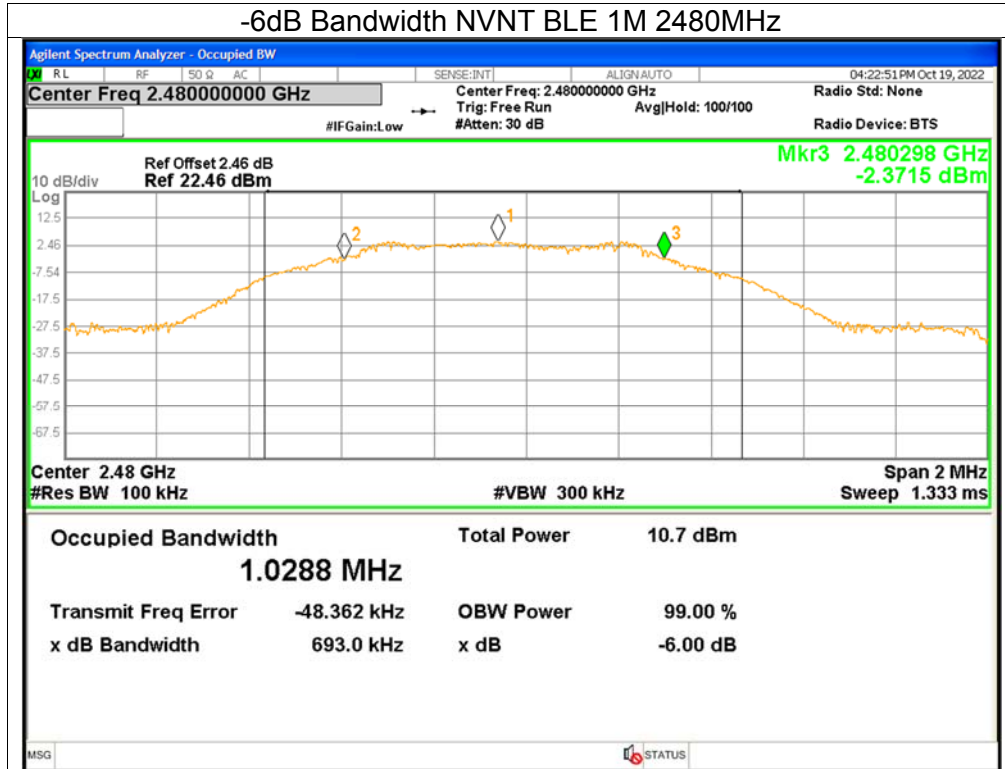



## 5. MAXIMUM POWER SPECTRAL DENSITY LEVEL

Condition	Mode	Frequency (MHz)	PSD (dBm/3kHz)	Limit (dBm/3kHz)	Verdict
NVNT	BLE 1M	2402	-11.98	$\leq 8$	Pass
NVNT	BLE 1M	2440	-11.3	$\leq 8$	Pass
NVNT	BLE 1M	2480	-10.42	$\leq 8$	Pass





Test Graphs

PSD NVNT BLE 1M 2402MHz

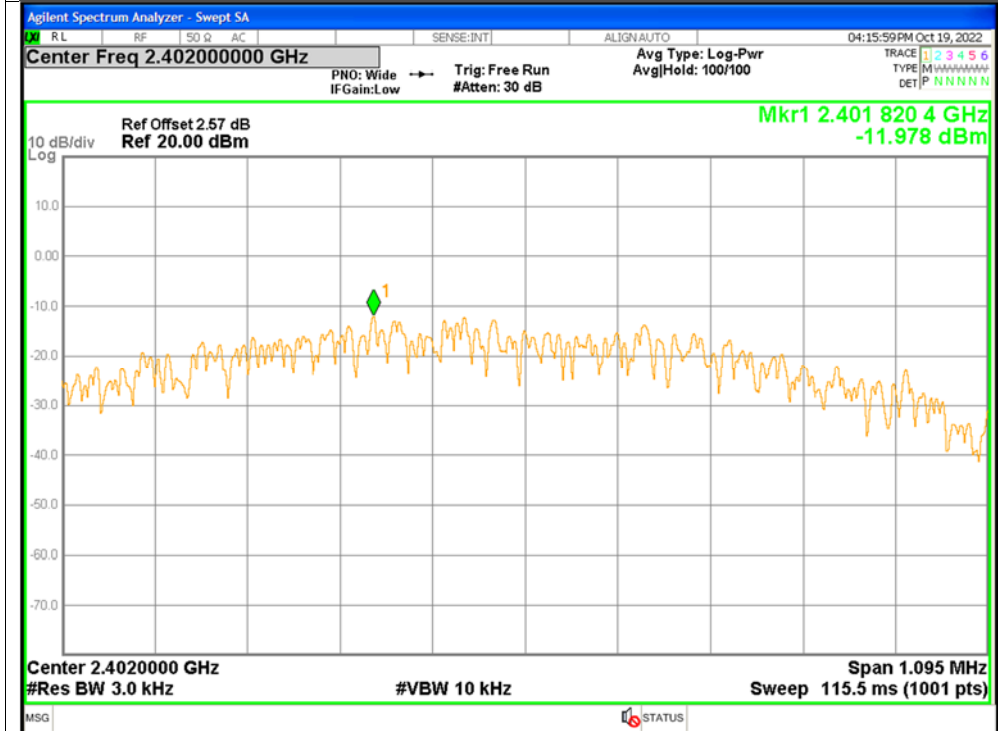

PSD NVNT BLE 1M 2440MHz

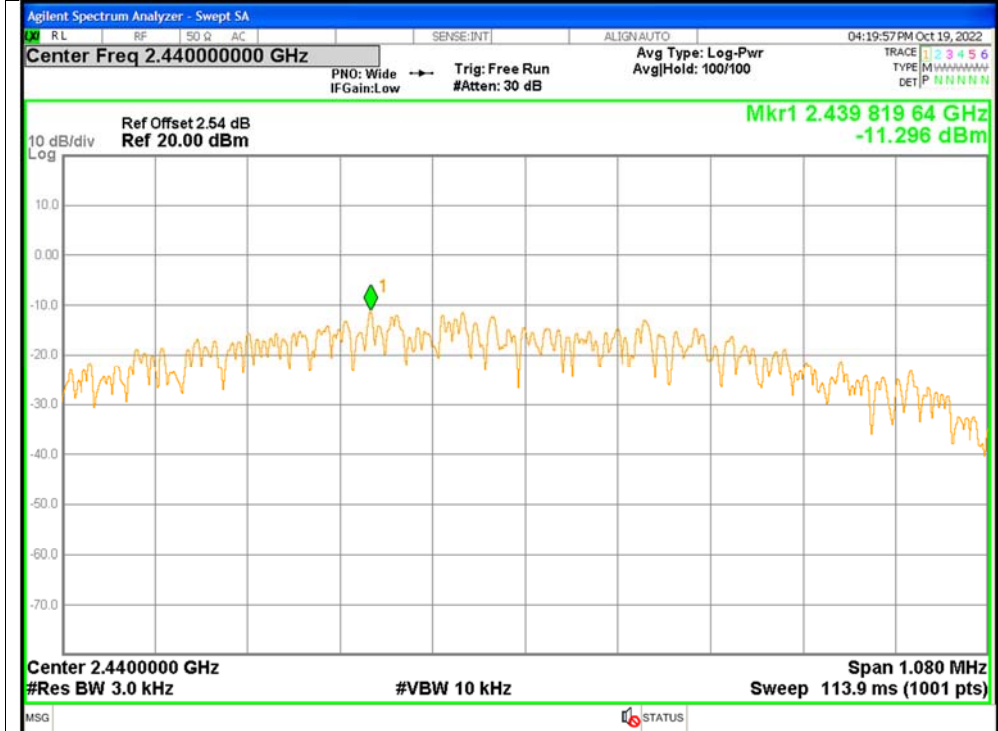



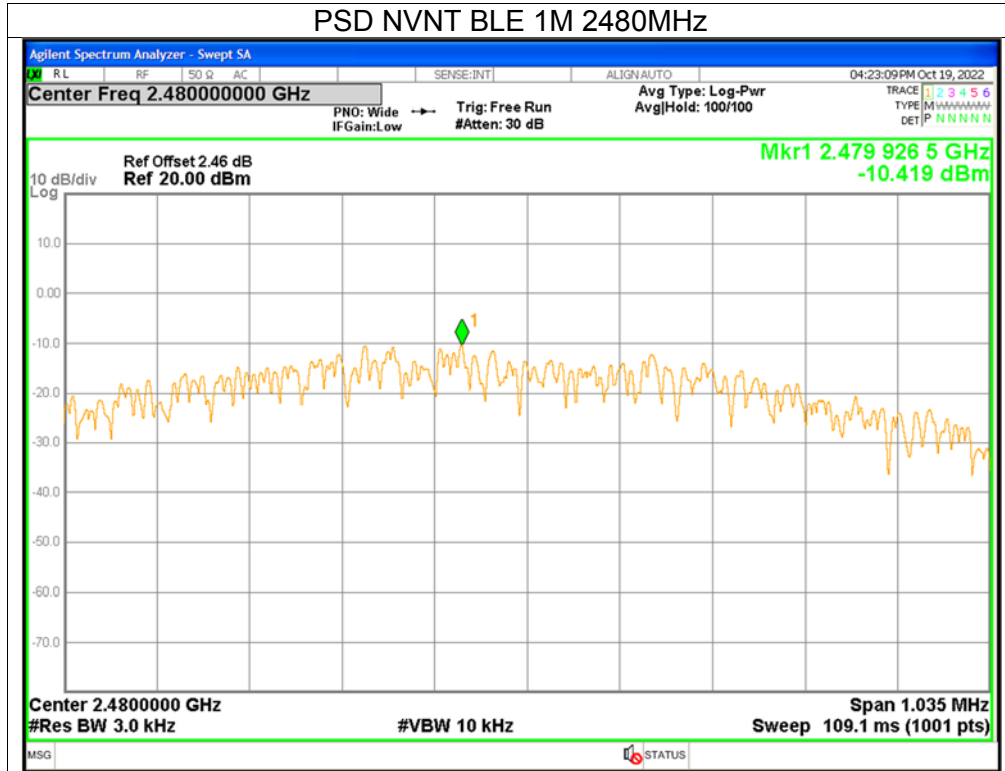



## 6. BAND EDGE

Condition	Mode	Frequency (MHz)	Max Value (dBc)	Limit (dBc)	Verdict
NVNT	BLE 1M	2402	-37.04	<=-20	Pass
NVNT	BLE 1M	2480	-43.07	<=-20	Pass





Test Graphs

Band Edge NVNT BLE 1M 2402MHz Ref

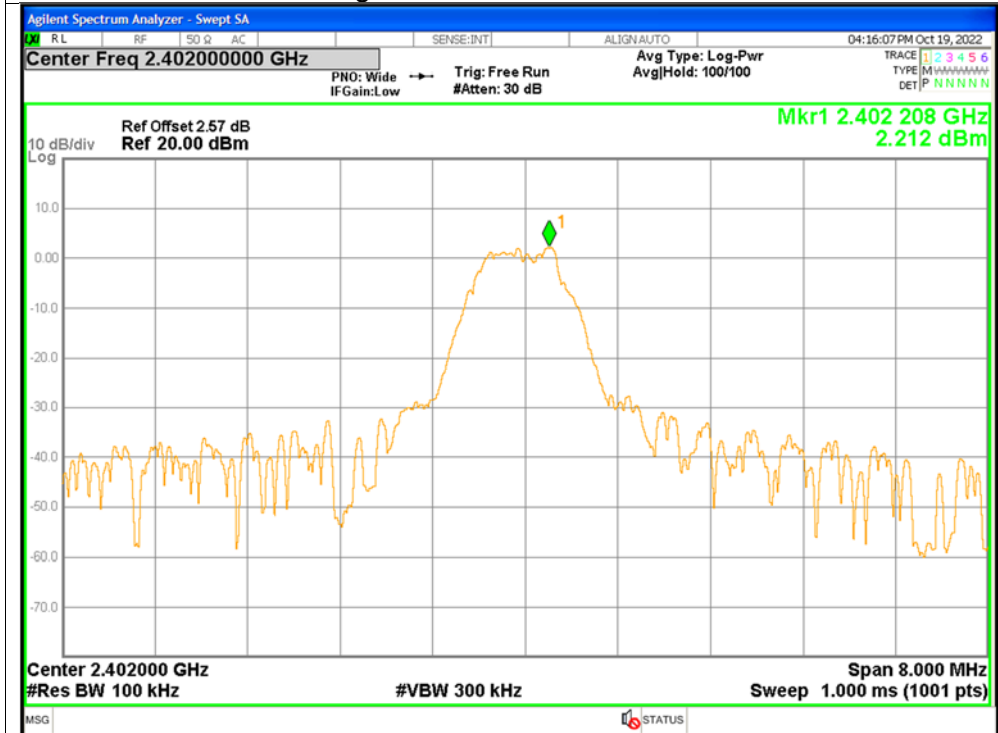

Band Edge NVNT BLE 1M 2402MHz Emission

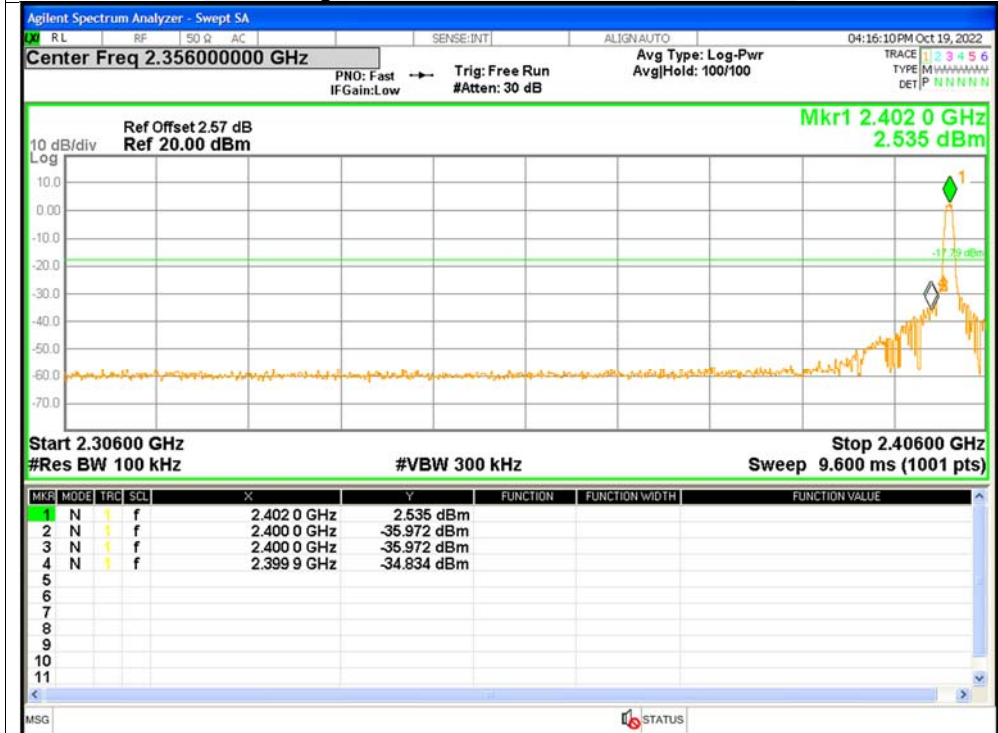



Band Edge NVNT BLE 1M 2480MHz Ref

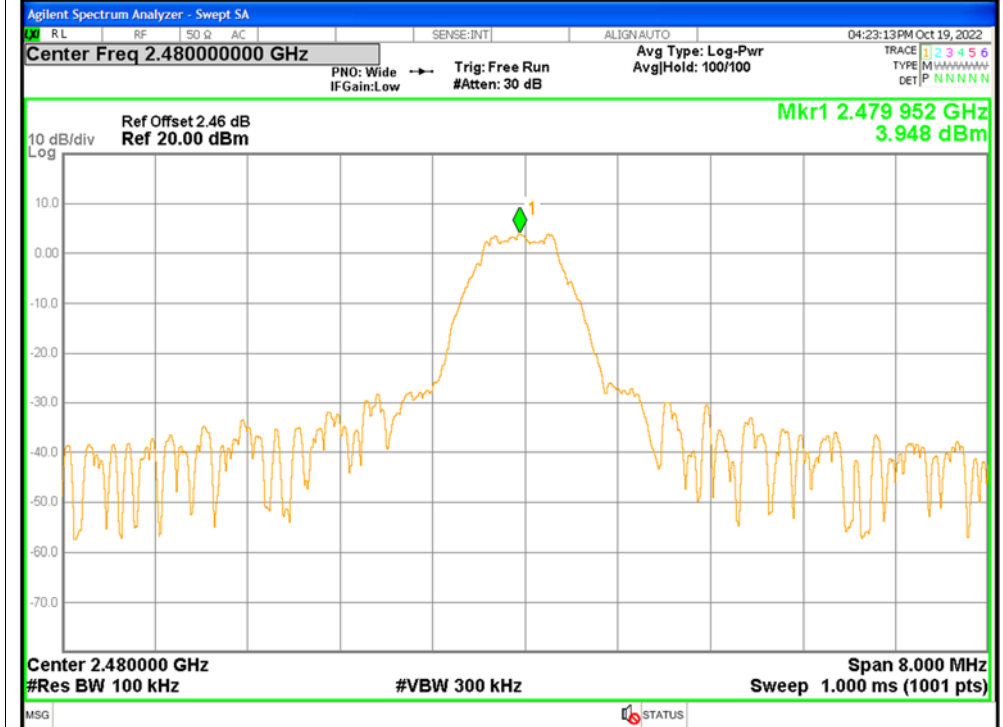

Band Edge NVNT BLE 1M 2480MHz Emission

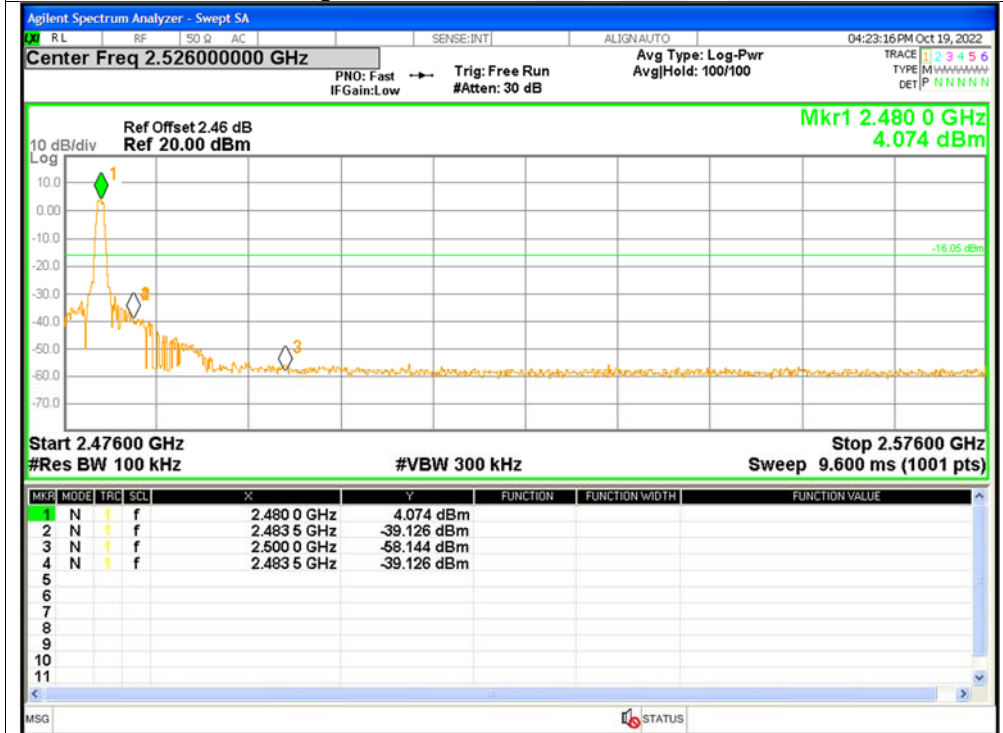



## 7. CONDUCTED RF SPURIOUS EMISSION

Condition	Mode	Frequency (MHz)	Max Value (dBc)	Limit (dBc)	Verdict
NVNT	BLE 1M	2402	-36.58	<=-20	Pass
NVNT	BLE 1M	2440	-48.61	<=-20	Pass
NVNT	BLE 1M	2480	-50.83	<=-20	Pass





Test Graphs

Tx. Spurious NVNT BLE 1M 2402MHz Ref

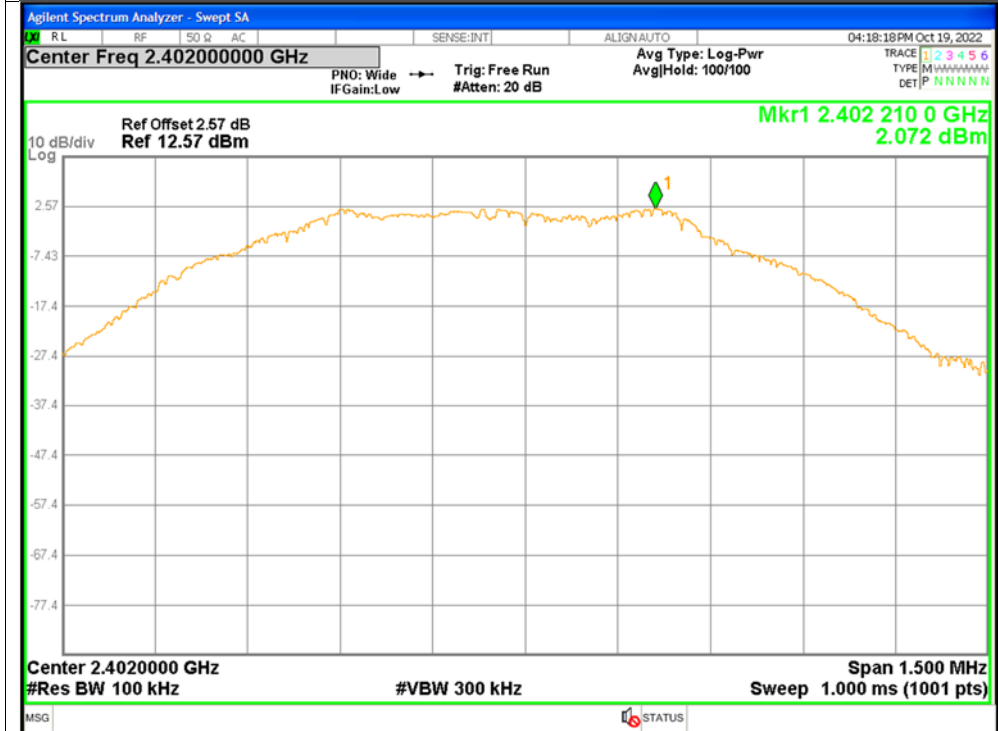

Tx. Spurious NVNT BLE 1M 2402MHz Emission

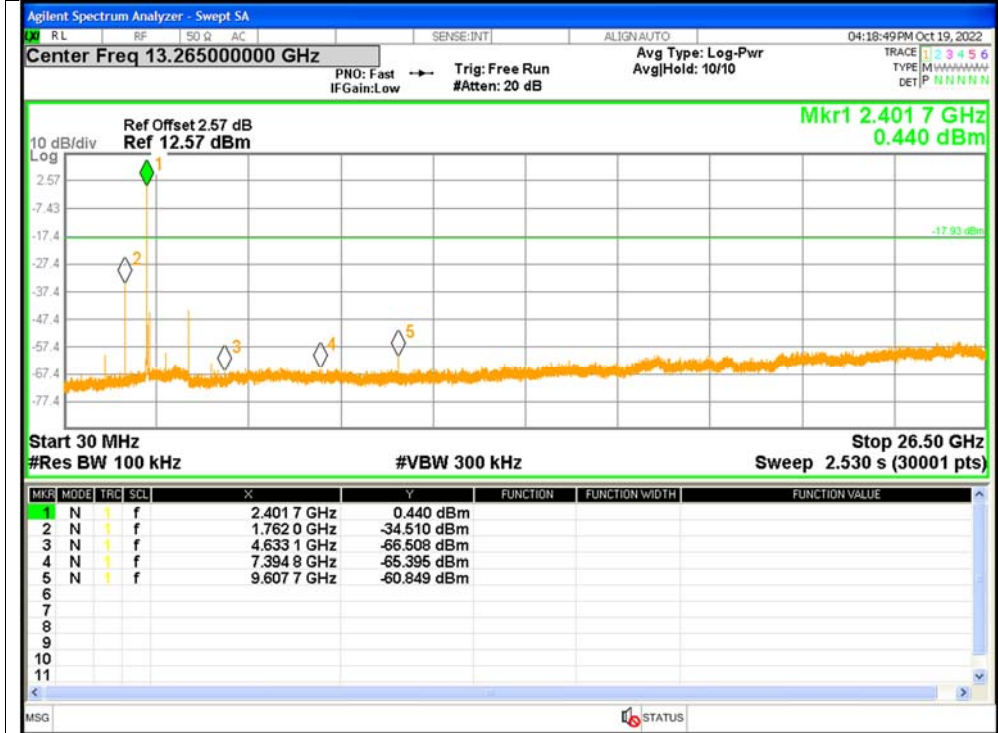



Tx. Spurious NVNT BLE 1M 2440MHz Ref

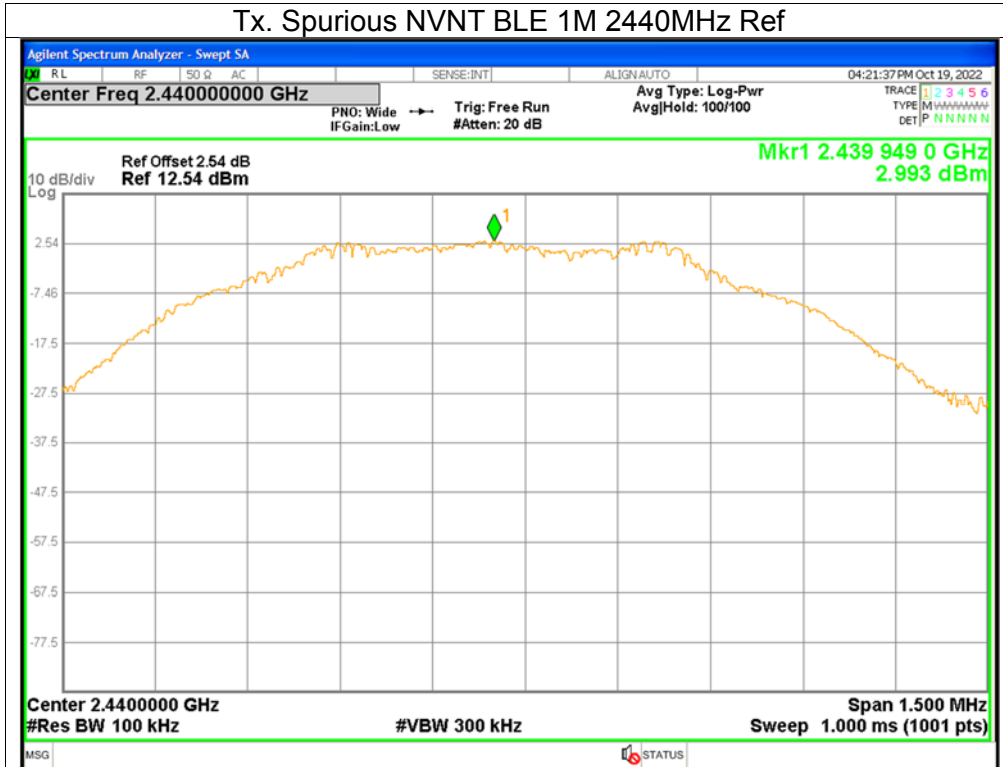

Tx. Spurious NVNT BLE 1M 2440MHz Emission

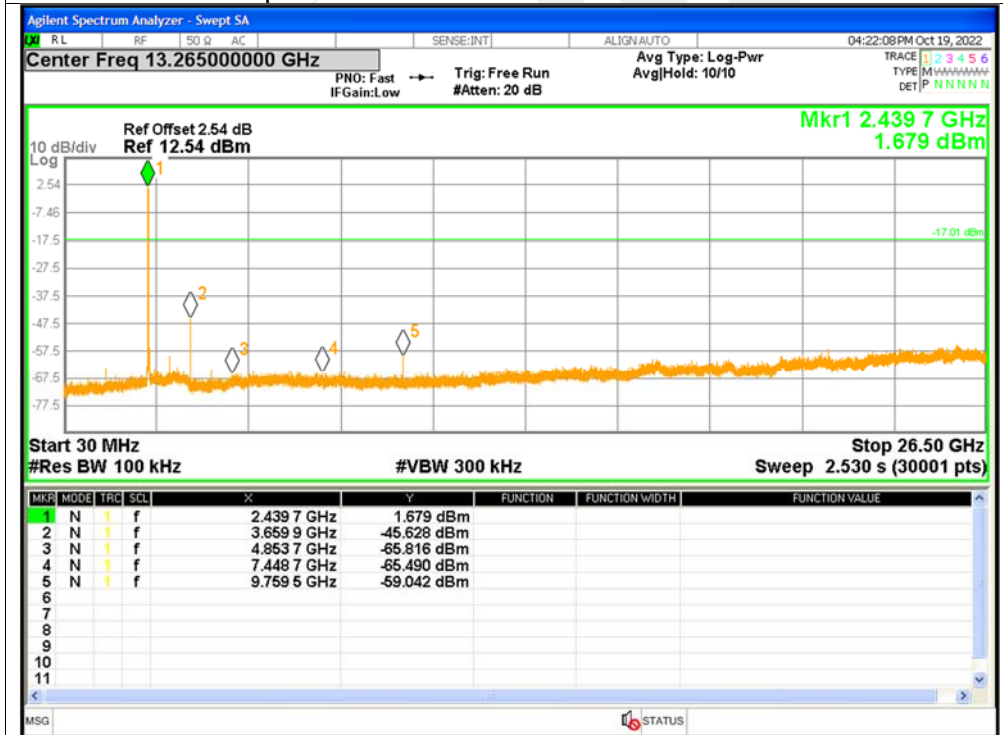



Tx. Spurious NVNT BLE 1M 2480MHz Ref

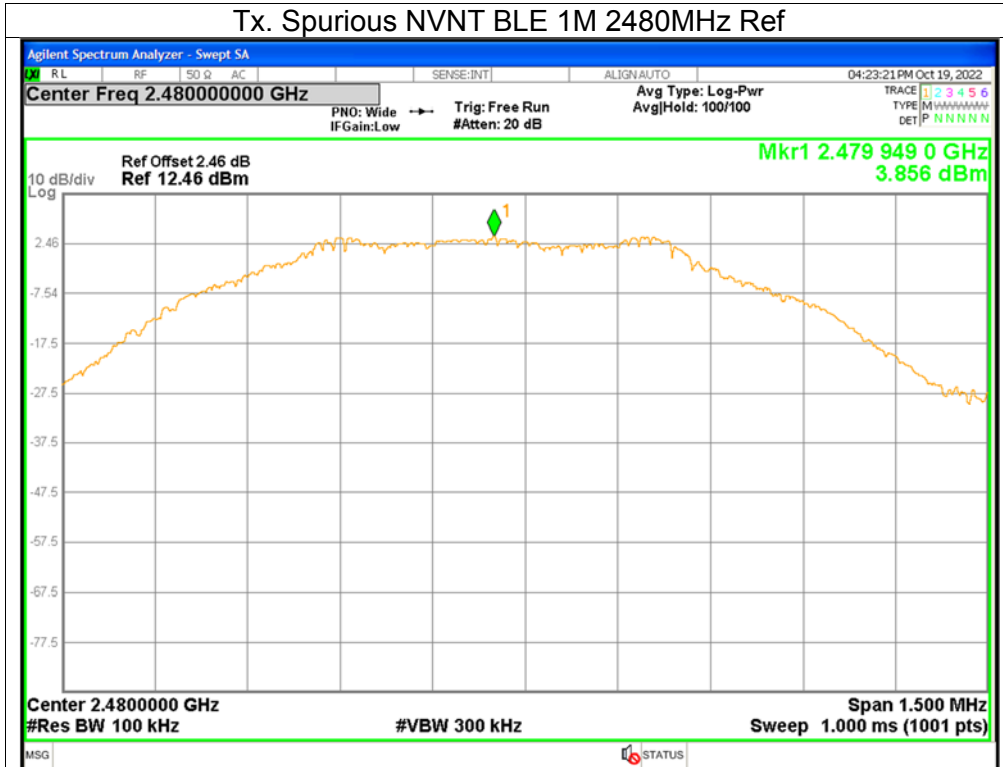

Tx. Spurious NVNT BLE 1M 2480MHz Emission

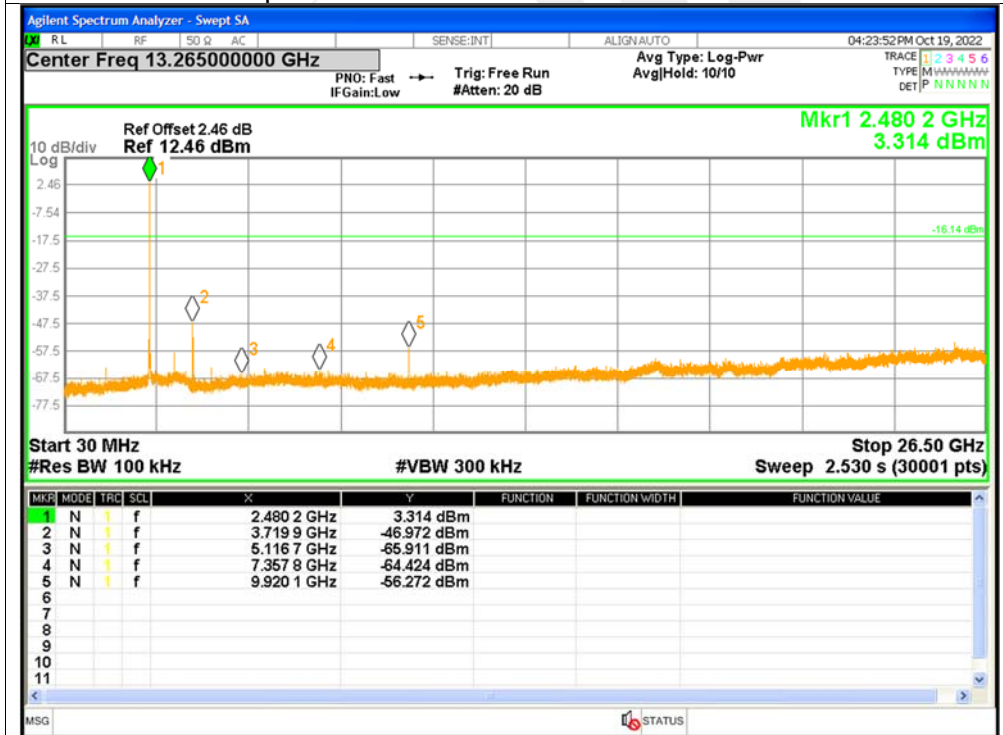





## APPENDIX 2- EUT TEST PHOTO

Note: See test photos in setup photo document for the actual connections between Product and support equipment.

\*\*\*\*\*END OF THE REPORT\*\*\*\*\*

