

User Guide



G&G P2022 Series Monochrome Laser Printer



It is recommended to carefully read this Guide before using the printer

Preface

Welcome to the G&G series products!

We heartily appreciate your using of G&G series products!

To protect your vital interests, please carefully read the following statements.

For more information, please visit our official website (www.ggimage.com).

Legal Notice

Trademark

G&G and G&G logos are registered trademarks of Zhuhai Ninestar Information Technology Co., LTD's affiliate.

Microsoft®, Windows®, Windows Server® and Windows Vista® are trademarks registered by Microsoft Corporation in the United States or other countries/regions.

Apple, AirPrint and Mac are trademarks of Apple Inc, registered in the U.S. and other countries. Use of the Works with Apple badge means that an accessory has been designed to work specifically with the technology identified in the badge and has been certified by the developer to meet Apple performance standards.

Mopria®, the Mopria® Logo, and the Mopria Alliance™ word mark and logo are registered and/or unregistered trademarks and service marks of Mopria Alliance, Inc. in the United States and other countries. Unauthorized use is strictly prohibited.

Wi-Fi® and Wi-Fi Protected Setup™ are registered trademarks of the Wi-Fi Alliance.

The ownership to the names of the software in this User Guide belongs to their respective owned companies in accordance with corresponding license agreement, and they are referred for instructions only.

All other product and brand names herein may be the registered trademarks, trademarks or service marks of their respective owners, and they are referred for instructions only.

Copyright

The copyright of this User Guide is owned by Zhuhai Ninestar Information Technology Co., Ltd.

It is prohibited to copy, translate, modify and transmit this User Guide by any means or forms without the prior written consent of Zhuhai Ninestar Information Technology Co., Ltd.

Version: V1.0

Disclaimer

For a better user experience, Zhuhai Ninestar Information Technology Co., Ltd reserves the right to make changes to the User Guide. The information contained herein is subject to change without notice.

Users are responsible for any damages arising from failing to follow this User Guide. Meanwhile, except the express warranty made in the product maintenance manual or service commitment, Zhuhai Ninestar Information Technology Co., Ltd does not make any express or implied warranty or guarantee to this User Guide (including composing or words).

Using this product to copy, print, scan certain documents or images or make other forms of operations may be prohibited by the local laws. If you are uncertain about the legality of using this product for certain documents or images, you should consult your legal advisor in advance.

Safety Precautions

Disconnect the power supply

The product should be placed close to or easily accessible to power sockets, so as to allow easy disconnection of power supply!

Laser Safety

The laser radiation is harmful to the human body. Since laser components are completely sealed in the printer, laser radiation will not leak. To avoid laser radiation, please do not randomly disassemble the printer!

The printer follows the provisions of Class 1 laser products under CFR standard.



The printer has a Class III B laser diode, which has no laser radiation leakage among laser components.

The laser components shall comply with the requirements of: U.S. Code of Federal Regulations, 21 CFR 1040, IEC 60825-1

The following label is attached to the laser components inside the printer:











or

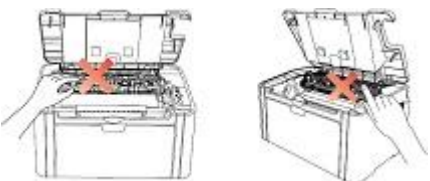

Safety Warning

Please note the following safety warnings before using the printer:

 Warning	
 There is a high-voltage electrode inside the printer. Before cleaning the printer, make sure the power is turned off!	
 Plugging and unplugging the power cord plug with a wet hand may result in an electric shock.	
 The fuser unit is hot during and after printing. Touching the fuser unit (the shaded area as shown) may cause burns!	
 The fuser unit bears a high temperature warning label. Please do not remove or damage this label.	

Precautions

Precautions before Using the Printer:

1. Read and understand all instructions;
2. Familiarize yourself with the basic principles associated with operating electrical appliances;
3. Comply with all warnings and instructions marked on the equipment or specified in the manual supplied with the equipment;
4. If the operating instructions conflict with the safety information, please refer back to the safety information, as you may have misunderstood the operating instructions. If you cannot resolve the conflicts, please call the Customer Service Hotline or contact a service representative for help;
5. Before cleaning the equipment, remove the power cord from the AC power supply outlet. Do not use liquid or aerosol cleaners;
6. Please make sure that the equipment is put on a stable desktop surface to avoid serious damage caused by the falling of the equipment;
7. Do not put the equipment near a radiator, an air conditioner, or a ventilation pipe;
8. Do not place any articles on top of the power cord. Do not put the equipment in a place where its power cord will be stepped on by people;
9. Outlets and extension cords must not be overloaded. This may reduce performance and could result in fire or electric shock;
10. Do not allow pets to chew on the AC power cord or the computer interface cable;
11. Do not allow sharp objects piercing equipment slot, so as to avoid contact with the high-voltage device, which otherwise may result in fire or electric shock. Take care not to spill liquids onto the equipment;
12. Do not disassemble the equipment so as to avoid the risk of electric shock. Necessary repairs may only be carried out by professional maintenance personnel.
Opening or removing the cover could result in an electric shock or other potential hazards. Incorrect disassembly and assembly could also result in an electric shock during future use;
13. If any one of the following occurs, disconnect the equipment from the computer and pull out the power cord from the AC wall socket and contact a qualified member of the service personnel for maintenance:
 - Liquid has been spilled into the equipment.
 - The equipment has been exposed to rain or water.
 - The equipment falls, or the cover is damaged.
 - Significant changes in the equipment's performance.
14. Only adjust the control mentioned in the instructions. Incorrect adjustment of other controls may result in damage and mean that professional maintenance personnel need to spend more time fixing it;
15. Do not use the equipment in a thunderstorm so as to avoid the risk of an electric shock. If possible, pull out the AC power cord during a thunderstorm;
16. If you continuously print multiple pages, the surface of the tray will become very hot. Take care not to touch this surface, and keep children away from this surface;
17. The signal wire of the device connected with the printer can not be connected to the outdoors;
18. Please ensure timely ventilation in case of a prolonged use or printing huge amounts of documents in a poorly ventilated room;
19. In standby status, the product will automatically enter into the power saving (sleep) mode if it does not receive any job order for a while (such as 1 minute); and it can realize zero power consumption only if it has not been connected with any external input power supply;
20. As the Class 1 equipment, the product must be connected to the power supply outlet with protective grounding line when using;

-
21. This product should be placed according to the shipping marks on the product package box during delivery;
22. This product is a kind of low-voltage equipment. When using this product below the specified voltage range, please refer to the product precautions or call G&G Aftersales Service Centre, if the toner comes off the printed contents, or the equipment starts slowly;
23. This product is sold as a complete machine. The consumers can go to G&G Aftersales Service Centre to purchase parts they need. If the product sold is inconsistent with the package list, please go to the specified Aftersales Service Centre to solve the problem;
24. Install this product in a place with the temperature between 10°C to 32.5°C, and the relative humidity between 20% to 80%;
25. For security and other reasons the printer may switch to intermittent printing after a certain amount of continuous printing.
26. This device contains licence-exempt transmitter(s)/receiver(s) that comply with Innovation, Science and Economic Development Canada's licence-exempt RSS(s). Operation is subject to the following two conditions:
- (1) This device may not cause interference.
 - (2) This device must accept any interference, including interference that may cause undesired operation of the device.
27. Radiation Exposure Statement:
- This equipment complies with Canada and FCC radiation exposure limits set forth for uncontrolled environments. This equipment should be installed and operated with a minimum distance of 20cm between the radiator and your body.
- This transmitter must not be co-located or operating in conjunction with any other antenna or transmitter.
28. This equipment has been tested and found to comply with the limits for a Class B digital device, pursuant to Part 15 of the FCC Rules. These limits are designed to provide reasonable protection against harmful interference in a residential installation. This equipment generates, uses and can radiate radio frequency energy and, if not installed and used in accordance with the instructions, may cause harmful interference to radio communications. However, there is no guarantee that interference will not occur in a particular installation.
- If this equipment does cause harmful interference to radio or television reception, which can be determined by turning the equipment off and on, the user is encouraged to try to correct the interference by one or more of the following measures:
- Reorient or relocate the receiving antenna.
 - Increase the separation between the equipment and receiver.
 - Connect the equipment into an outlet on a circuit different from that to which the receiver is connected.
 - Consult the dealer or an experienced radio/TV technician for help.
29. This device complies with Part 15 of the FCC Rules. Operation is subject to the following two conditions:
- (1) this device may not cause harmful interference, and
 - (2) this device must accept any interference received, including interference that may cause undesired operation.
30. Warning: Changes or modifications to this unit not expressly approved by the party responsible for compliance could void the user's authority to operate the equipment.
31. The power consumption of the product is less than 3.00w in networked standby if all wired network ports

are connected and all wireless network ports are activated;

32. To maintain compliance with the RF exposure guidelines, place the product at least 20cm from nearby persons.

33. Please keep this User Guide properly.

Regulatory Information



This symbol indicates that, at the end of your product's life, it must not be discarded as domestic waste. Instead, you should dispose of your used equipment at a designated collection point for the recycling of waste electrical and electronic equipment. Ref: EU Directive 2002/96/EC on Waste Electrical and Electronic Equipment (WEEE). Please contact your distributor / supplier for further information.



This product is suitable for indoor use only.

European Community (EC) directives conformity

This product complies with the protection requirements of EC directives 2014/30/EU and 2014/35/EU on the approximation and harmonization of the laws of the Member States relating to electromagnetic compatibility and safety of electrical equipment designed for use within certain voltage limits.



Radio Equipment directive 2014/53/EU only for models ending with suffix "W".

The manufacturer of this product is: Zhuhai Ninestar Information Technology Co., Ltd., Building 02,06 and 08, No.888 Shengping Avenue, Pingsha Town, Zhuhai City, Guangdong Province, 519000 PR China.

A declaration of conformity to the requirements of the Directives is available upon request from the Authorized Representative.

This product satisfies the Class B limits of EN 55032 / EN 55035 and safety requirements of EN 62368-1.



This printer is fully compliant with the ROHS Directive 2009/95/EC and the requirements of the revised Directive 2011/65/EU for managing toxic and hazardous substances.

Table of Contents





Preface	I
Legal Notice.....	I
Safety Precautions.....	II
Precautions.....	IV
Regulatory Information.....	VI
Table of Contents.....	VII
1. Before Using the Printer	1
1.1. Packing List.....	1
1.2. Components of the Printer.....	2
1.3. Laser Toner Cartridge	3
2. Paper and Print Media	4
2.1. Paper Specification	4
2.2. Special Paper.....	5
2.3. Loading Paper.....	6
2.3.1. Loading into the Automatic Feeder Tray.....	6
2.4. Nonprinting Area	7
2.5. Guidelines for Paper Use	8
3. Driver installation and uninstallation	9
3.1. How to install Windows printer driver.....	9
3.1.1. One-click Installation (For Windows and macOS)	9
3.1.2. More setup methods	24
3.2. Uninstall Driver.....	39
3.2.1. Method to uninstall driver under Windows.....	39
3.2.2. Method to uninstall driver under macOS	39
4. Wired Network Settings (For wired network printer models)	40
4.1. Set IP Address	40
4.2. Install the Printer to Network	41
4.3. Setting Network Products.....	42
4.3.1. View or Change Network Settings.....	42
4.3.2. Set or Change Web Server Login Password	42
4.3.3. Restore to Factory Settings.....	42
5. Wireless network setup (applicable to Wi-Fi models)	43
5.1. Basic structure mode.....	43
5.1.1. Wireless network setup tools.....	43
5.1.2. Wi-Fi Protected Setup (WPS) setup	49
5.1.3. How to disable the Wi-Fi network connected.....	49
5.2. Wi-Fi hotspot mode	50
5.2.1. Preliminary preparations	50
5.2.2. Wi-Fi Hot Connection	50
5.2.3. Wi-Fi Hotspot Configuration	50
5.3. Wireless network setup FAQs	50
6. Mobile Print (for models with Wi-Fi function only)	52
6.1. "G&G SmartPro" APP	52
6.1.1. Operating systems supported	52

6.1.2. How to download G&G SmartPro APP	52
6.1.3. How to use this "G&G SmartPro" APP	52
6.2. Mopria mobile print.....	53
6.3. AirPrint mobile print.....	53
7. Print	54
7.1. Print Function	54
7.2. Opening Help Document	55
7.3. Manual Duplex	56
7.4. Cancel Print Job.....	59
8. Control Panel	60
8.1. Control Panel Overview for P2022 Series	60
8.1.1. Functions of Buttons on the Control Panel	60
8.1.2. Function of LED Indicators on the Control Panel.....	61
9. Routine Maintenance	64
9.1. Cleaning the Printer.....	64
9.2. Maintenance of Laser Toner Cartridge	65
9.2.1. Use and Maintenance of Laser Toner Cartridge.....	65
9.2.2. Service Life of Laser Toner Cartridge.....	66
9.2.3. Replace Laser Toner Cartridge	66
10. Troubleshooting	69
10.1. Clearing Jammed Paper.....	69
10.1.1. Paper Jam in the Feed Port	69
10.1.2. Paper Jam inside the Printer	70
10.2. Common Troubleshooting	72
10.2.1. Common Trouble	72
10.2.2. Image Defects.....	74
11. Product Specification	77
11.1. P2022 Series Specification.....	77
11.1.1. Specification Overview.....	77
11.1.2. Printing Specification.....	78

1. Before Using the Printer

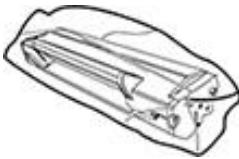
1.1. Packing List

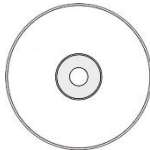
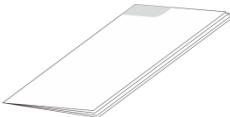
When you open the package, make sure that the following parts are included in the carton:

P2022 Series	Name	Quantity
	Printer	1
	Laser Toner Cartridge	1
	USB Interface Cable	1
	Power Cord	1
	CD-ROM	1
	Quick Setup Guide	1
	G&G Warranty	1

 **Note:** • The G&G Warranty may not be attached in some regions.

1.2. Components of the Printer

| Front View

Serial No. P2022 Series

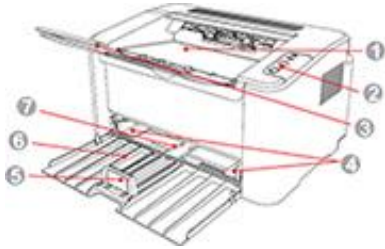

-
- | | |
|---|-----------------------|
| 1 | Output Bin |
| 2 | Control Panel |
| 3 | Output Tray |
| 4 | Automatic Feed Guide |
| 5 | Paper Stop |
| 6 | Feeder Tray |
| 7 | Automatic Feeder Tray |
-

| Rear View



Note: • The rear view of the printer may vary depending on the models and functions.

Serial No. P2022 Series



-
- | | |
|---|-------------------|
| 1 | Network Interface |
| 2 | USB Interface |
| 3 | Power Switch |
| 4 | Power Interface |
-

1.3. Laser Toner Cartridge

| Service Life of the Laser Toner Cartridge

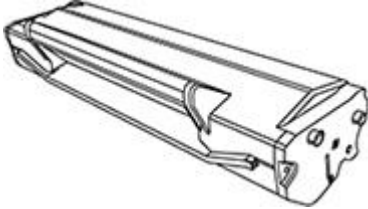
Series Name	P2022 Series
Diagram	
Type	Average Print Volume
Laser Toner Cartridge with Standard Capacity	About 1600 Pages (The above data is based on ISO/IEC 19752 standard)
Laser Toner Cartridge with High Capacity	N/A

 **Note:**• The model is subject to increase without notice.

- Consumables capacity may vary depending on the types used.
 - The Company does not recommend using consumables other than that of the original G&G consumables.
 - Any damages caused by using non-G&G original consumables are not covered by the Warranty.
-

2. Paper and Print Media

2.1. Paper Specification

P2022 Series Automatic Feeder Tray	Media Type	Plain, thin, special paper (transparency, cardstock, label, envelope, thick, etc.).
	Media Size	A4, A5, JIS B5, ISO B5, A6, Letter, Legal, Executive, Folio, Oficio, Statement, Japanese Postcard, Monarch Env, DL Env, C5 Env, C6, Env, No.10 Env, ZL, Big 16K, Big 32K, 16K, 32K, B6, Yougata4, Postcard, Younaga3, Nagagata3, Yougata 2, custom, etc.
	Media Weight	60~163g/m ²
	Maximum Capacity of the Tray	150 pages 80g/m ²



- Note:**
- It is recommended to use the standard paper for the printer.
 - Extensive use of special paper may affect the service life of the printer.
 - The print media that does not meet the guidelines set out in this User Guide may result in poor print quality, increased paper jam and excessive wear of the printer.
 - Properties such as weight, composition, texture and humidity are important factors affecting the printer performance and output quality.
 - Please note the following matters when selecting the print media:
 1. Desired print effect: The print media selected should meet the requirement of the print tasks.
 2. Surface smoothness: The smoothness of the print media may affect the sharpness of the print outcome.
 3. Some print media may meet all the use guidelines contained herein, but they still can not bring satisfactory effect. This may be due to incorrect operation, inappropriate temperature and humidity, or other factors beyond the control of G&G. Before purchasing large quantities of print media, make sure that the print media meets the specifications specified in this User Guide.
 4. Using print media that does not meet these specifications may cause damage to the printer.
-

2.2. Special Paper

This printer supports using the special paper for printing. Special paper includes: label, envelope, transparency, thick, cardstock, etc.

-
-  **Note:** • When using special paper or print media, be sure to select matched print type and size in the print settings so as to get the best print effect.
- When using special media to print, it is recommended to load one piece of paper at one time. For P2022 series, load one piece of special paper into the automatic feeder tray at one time.
-

| Please observe the following standards:

Types of Print Media	Correct Practices	Incorrect Practices
Label	Use labels with no exposed lining paper only. Labels shall be put flat when using. Use labels of full sheet only. There is no guarantee that all the labels in the market can meet corresponding requirements.	Use wrinkled, blistering or damaged labels.
Envelope	Envelopes should be loaded evenly.	Use wrinkled, nicked, stuck or damaged envelopes. Use envelopes with clips, snaps, Windows, or coated linings. Use envelopes with self-adhesive stickers or other synthetic materials.
Transparency	Use only transparencies approved for use in laser printers.	Use transparent print media that is not suitable for laser printers.
Thick, Cardstock	Use only heavy paper that is approved for use in laser printers and meets the weight specifications of this printer.	Use paper whose weight exceeds the recommended media specifications of this printer.

2.3. Loading Paper

2.3.1. Loading into the Automatic Feeder Tray

a) Open the feeder tray.

P2022 Series

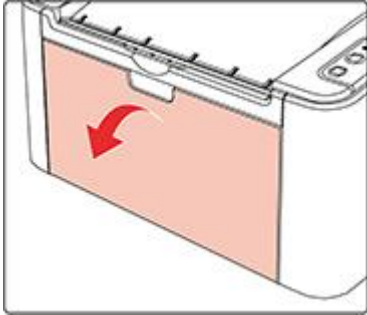

b) Slide the automatic feed guides to match both sides of the paper.

P2022 Series

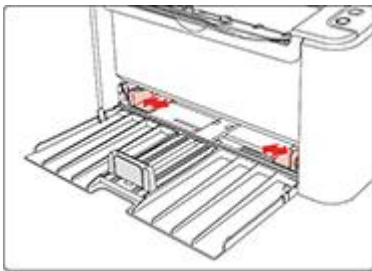

c) Raise the output tray to avoid the paper from slipping and falling.

P2022 Series

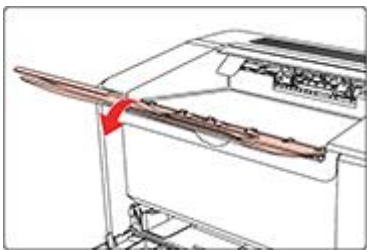

d) Load the paper into the automatic feeder tray with the print-side up.

P2022 Series

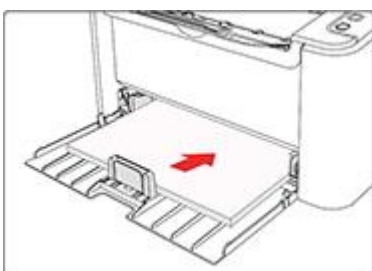

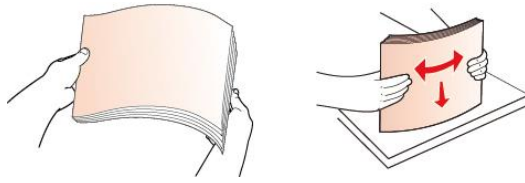

 **Note:** • Before loading paper, please unfold the stacked paper to avoid a paper jam or feed error, and then load the paper into the tray print-side up.

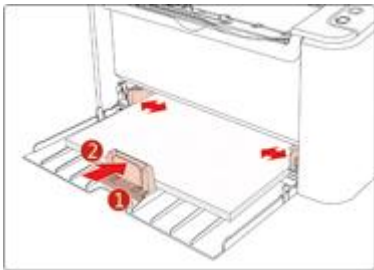

e) Adjust the paper stop to keep the paper in position. To ensure normal paper feeding, adjust the bottom paper stop ① into the slot to keep it from slipping out, and then adjust the blue stop ② to match the paper size.

P2022 Series



 **Note:** • If the paper loaded into the automatic feeder tray at one time exceeds 150 pages, paper will jam or cannot be fed in.

- When using the printed paper, please make the side to be printed (the blank side) up.
- When printing on A5 paper, it is recommended that the paper is fed in landscape orientation, which can extend the service life of the laser toner cartridge.

2.4. Nonprinting Area

The shaded section indicates the nonprinting area.

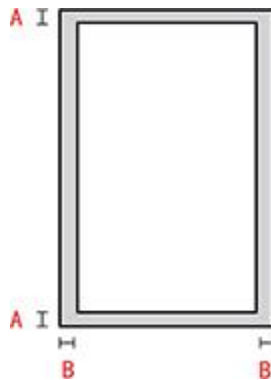

Usage	Paper Size	Top and Bottom Margins (A)	Left and Right Margins (B)
Printing	A4	5 mm (0.197 inch)	5 mm (0.197 inch)
	Letter	5 mm (0.197 inch)	5 mm (0.197 inch)

2.5. Guidelines for Paper Use

- Paper or manuscript with rough texture, concave and convex, oil stain and good smoothness has poor printing performance.
- Please make sure that there is no dust, fluff, etc. on the paper.
- Paper shall be put on a flat surface and stored under a cool and dry environment.

3. Driver installation and uninstallation

3.1. How to install Windows printer driver

This device supplies driver setup applications for Windows and macOS. We recommend One-click installation, which helps you install the driver automatically in a faster and easier way. Should you encounter trouble when using the One-click installation, you may try more setup methods.

 **Note:** • Driver installation interface may differ because of different models and functions, so the schematic diagram is only for your reference.

3.1.1. One-click Installation (For Windows and macOS)

One-click installation provides three methods of installation: connect the printer via USB cable, connect the printer via wired network, and connect the printer via wireless network. You can choose one of them according to your habit.

3.1.1.1. Connect printer via Wi-Fi

Before installing printer driver, please check if your printer is connected to the Wi-Fi properly. If not, please follow [Section 3.1.1.1.1](#) for installation; and if yes, please follow [Section 3.1.1.1.2](#) for installation.

 **Note:** • You can print "Network configuration page" to confirm printer network connection status to see if printer is connected with network (Please see [Section 8.1.1.3](#) for how to print).

3.1.1.1.1. Printer not connected to Wi-Fi

3.1.1.1.1.1. Configure Wi-Fi and install driver via USB cable

In this section, setup will be introduced in "PC connected to router via Wi-Fi" and "PC connected to router via cable".

 **Note:** • Printer Wi-Fi configuration only supports 2.4 GHz networks.

I. Connect computer to router via Wi-Fi

1. Computer is already connected to router via Wi-Fi.
2. Connect the printer to computer via USB cable, then power the printer on.
3. Place the attached installation CD in the computer CD-ROM:

For Windows:

- Windows XP system: automatically run the installation procedure.
- Windows 7/Vista/Server 2008 system: Pop up "Autoplay" interface, click "Setup.exe" to run the installation procedure.
- Windows 8 system: When the "DVD RW driver" window pops up from the right top corner of computer desktop, click anywhere in the pop-up window, then click "Setup.exe" to run the installation procedure.
- Windows 10/11 system: When the "DVD RW driver" window pops up from the right top corner of computer desktop, click anywhere in the window, then click "Setup.exe" to run the installation procedure.



Note:• Some computers may be unable to auto play the CD because of system configuration. Please double click "Computer" icon, find "DVD RW driver", then double click "DVD RW driver" to run the installation procedure.

For macOS:

- Double-click on "XXX Series_Mac_Driver" - "Install Tool". (The XXX in XXX Series refers to product model.)
- 4. Read and agree to the terms contained in the End User License Agreement and the Privacy Policy, click the "Next" button in the lower right corner of the interface to enter the driver installation interface.
- 5. For Windows, follow Step 6. For macOS, enter PC password before proceeding to Step 6.
- 6. Click on "One-click installation" button under Wi-Fi to install the driver.

Welcome to the product, please install the driver by follow steps

- 1 Power on
- 2 Select the way of connection

If the button displays "Disconnected", please click on  to see the video, it will show you how to connect



Way 1: Connect with USB

One-click installation

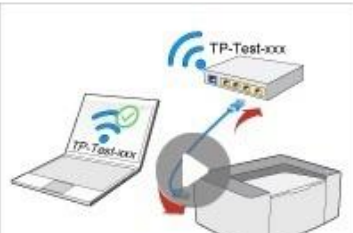

Way 2: Connect with wireline network

Disconnected



Way 3: Connect with Wi-Fi

One-click installation

Tips: If the one-click installation does not satisfy your usage scenario, you can try  [manual installation](#)

[User Guide](#)



Note:• You can put your mouse cursor in the "One-click installation" button to check the popup information in order to confirm if the current printer is the one you need to install through IP address before you click the button.

- You can check the printer IP address through "Network configuration page" (Please see [Section 8.1.1.3](#) for how to print)

-
- If the Install Tool finds only one printer, it will proceed to network configuration and driver installation automatically when you click on "One-click installation" under Wi-Fi. (For macOS, authorization is required before printer Wi-Fi can be configured.)



- If the Install Tool finds more than one printer, a printer list will pop up when you click on "One-click installation" under Wi-Fi. You need to select "Configure printer Wi-Fi and install via USB cable", check USB printer, and click on "OK", so the Tool can proceed to network configuration and driver installation automatically. (For macOS, authorization is required before printer Wi-Fi can be configured.)

Please select the printer you would like to install

Configure and install Wi-Fi via USB

Printer Name	Port
<input checked="" type="checkbox"/> X X X Series	USB001

Wireless network printer

Printer Name	IP Address	Host name
<input checked="" type="checkbox"/> X X X Series PCL6 0001	10.10.148.150	X X X -02D22B

Install the printer from the list with a hostname 

Tips: If your printer is not in the list, please check the printer network status and see if it is in the same network as the current PC

 **Note:** When the printer IP address changes under printer driver installed with host ID, you can also directly print without re-installing the driver. If you need to install the printer driver with the host ID, please check the option "Install the printer in the list with host ID".

7. After the installation, click "Print & Test Page" button. If your printer prints the test page successfully, it means that you have installed the driver correctly.

II. Connect computer to router via network cable

1. Connect computer to router via network cable.
2. Connect the printer to computer via USB cable, then power the printer on.
3. Place the attached installation CD in the computer CD-ROM:

For Windows:

- Windows XP system: automatically run the installation procedure.
- Windows 7/Vista/Server 2008 system: Pop up "Autoplay" interface, click "Setup.exe" to run the installation procedure.
- Windows 8 system: When the "DVD RW driver" window pops up from the right top corner of computer desktop, click anywhere in the pop-up window, then click "Setup.exe" to run the installation procedure.
- Windows 10/11 system: When the "DVD RW driver" window pops up from the right top corner of computer desktop, click anywhere in the window, then click "Setup.exe" to run the installation procedure.

 **Note:** Some computers may be unable to auto play the CD because of system configuration. Please double click "Computer" icon, find "DVD RW driver", then double click "DVD RW driver" to run the installation procedure.

For macOS:

- Double-click on “XXX Series_Mac_Driver” – “Install Tool”. (The XXX in XXX Series refers to product model.)
- 4. Read and agree to the terms contained in the End User License Agreement and the Privacy Policy, click the “Next” button in the lower right corner of the interface to enter the driver installation interface.
- 5. For Windows, follow Step 6. For macOS, enter PC password before proceeding to Step 6.
- 6. Click on “One-click installation” button under Wi-Fi to install the driver.

Welcome to the product, please install the driver by follow steps

- 1** Power on
- 2** Select the way of connection

If the button displays "Disconnected", please click on  to see the video, it will show you how to connect



Way 1: Connect with USB

One-click installation



Way 2: Connect with wireline network

Disconnected



Way 3: Connect with Wi-Fi

One-click installation

Tips: If the one-click installation does not satisfy your usage scenario, you can try  [manual installation](#)

[User Guide](#)

 **Note:** • You can put your mouse cursor in the "One-click installation" button to check the popup information in order to confirm if the current printer is the one you need to install through IP address before you click the button.

- You can check the printer IP address through "Network configuration page" (Please see [Section 8.1.1.3](#) for how to print).

- If the Install Tool finds only one printer, a wireless network configuration dialogue will pop up when you click on "One-click installation" under Wi-Fi. Enter the SSID and password for the network you desire, click on "OK", and the setup will start. The setup may take a while, depending on your PC configuration. Please wait.

1. Please click on "Printing wireless network information page" to get the network name and encryption method. Please skip this step if you already know the network name and encryption method.

[Printing wireless network information page](#)

2. Please enter wireless network user name and password.

Network Name(SSID):

Encryption method:

Password:

Show password:

[Back](#) [OK](#)

- If your software has searched more than one printers, the printer list interface will pop up. You need to configure the current printer which is connected via USB cable to wireless network and install driver. Please select "Configure the print via USB and install" on the printer list interface and check the USB printer option. Click the "Confirm" button, and the wireless network configuration interface will pop up. Input the wireless SSID and password that you need, then click "Confirm" button, and enter into installation process. The process may need some time, and the duration is related to your computer configuration, please wait patiently.

Please select the printer you would like to install

Configure and install Wi-Fi via USB

Printer Name	Port
<input checked="" type="checkbox"/> X X X Series	USB001

Wireless network printer

Printer Name	IP Address	Host name
<input checked="" type="checkbox"/> X X X Series PCL6 0001	10.10.148.150	X X X -02D22B

Install the printer from the list with a hostname 

Refresh

Tips: If your printer is not in the list, please check the printer network status and see if it is in the same network as the current PC

Back

OK

1. Please click on "Printing wireless network information page" to get the network name and encryption method. Please skip this step if you already know the network name and encryption method.

Printing wireless network information page

2. Please enter wireless network user name and password.

Network Name(SSID):

Test-AP2

Encryption method:

WPA/WPA2

Password:

••••••••

Show password:

Back

OK

 **Note:** When the printer IP address changes under printer driver installed with host ID, you can also directly print without re-installing the driver. If you need to install the printer driver with

the host ID, please check the option "Install the printer in the list with host ID".

7. After the installation, click "Print & Test Page" button. If your printer prints the test page successfully, it means that you have installed the driver correctly.

3.1.1.1.1.2. Connect computer to printer via Wi-Fi direct and install the driver

Connect the computer to printer via a direct Wi-Fi connection. It is applicable to wireless network without infrastructure mode, but it still needs scenario of temporary use of printer via wireless network. You can directly connect the computer that has wireless function to the printer to realize printing function.

1. Turn the power of printer and computer on.
2. Connect computer to the Wi-Fi Direct network of the printer (please refer to [Section 5.2.2](#) for setup method).
3. Place the attached installation CD in the computer CD-ROM:

For Windows:

- Windows XP system: automatically run the installation procedure.
- Windows 7/Vista/Server 2008 system: Pop up "Autoplay" interface, click "Setup.exe" to run the installation procedure.
- Windows 8 system: When the "DVD RW driver" window pops up from the right top corner of computer desktop, click anywhere in the pop-up window, then click "Setup.exe" to run the installation procedure.
- Windows 10/11 system: When the "DVD RW driver" window pops up from the right top corner of computer desktop, click anywhere in the window, then click "Setup.exe" to run the installation procedure.

 **Note:** • Some computers may be unable to auto play the CD because of system configuration. Please double click "Computer" icon, find "DVD RW driver", then double click "DVD RW driver" to run the installation procedure.

For macOS:

- Double-click on "XXX Series_Mac_Driver" - "Install Tool". (The XXX in XXX Series refers to product model.)
4. Read and agree to the terms contained in the End User License Agreement and the Privacy Policy, click the "Next" button in the lower right corner of the interface to enter the driver installation interface.
 5. For Windows, follow Step 6. For macOS, enter PC password before proceeding to Step 6.
 6. The setup will start when you click on "One-click installation" under Wi-Fi. The setup may take a while, depending on your PC configuration. Please wait.

Welcome to the product, please install the driver by follow steps

- 1 Power on
- 2 Select the way of connection

If the button displays "Disconnected", please click on  to see the video, it will show you how to connect



Way 1: Connect with USB

Disconnected



Way 2: Connect with wireline network

Disconnected



Way 3: Connect with Wi-Fi

One-click installation

Tips: If the one-click installation does not satisfy your usage scenario, you can try  [manual installation](#)

[User Guide](#)

Tips:

Installing the driver software will take some time. Please be patient.

Please do not turn off the computer or run other operations that may affect normal installation.

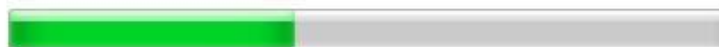

7. After the installation, click "Print & Test Page" button. If your printer prints the test page successfully, it means that you have installed the driver correctly.

3.1.1.1.2. The printer is already connected to wireless network

1. The printer is already connected to wireless network, you can print the "Network configuration page" to check.(See [Section 8.1.1.3](#) to for how to print).

2. Connect the computer to printer network.

3. Place the attached installation CD in the computer CD-ROM:

For Windows:

- Windows XP system: automatically run the installation procedure.
- Windows 7/Vista/Server 2008 system: Pop up "Autoplay" interface, click "Setup.exe" to run the installation procedure.
- Windows 8 system: When the "DVD RW driver" window pops up from the right top corner of computer desktop, click anywhere in the pop-up window, then click "Setup.exe" to run the installation procedure.
- Windows 10/11 system: When the "DVD RW driver" window pops up from the right top corner of computer desktop, click anywhere in the window, then click "Setup.exe" to run the installation procedure.

 **Note:** • Some computers may be unable to auto play the CD because of system configuration. Please double click "Computer" icon, find "DVD RW driver", then double click "DVD RW driver" to run the installation procedure.

For macOS:



- Double-click on "XXX Series_Mac_Driver" - "Install Tool". (The XXX in XXX Series refers to product model.)
4. Read and agree to the terms contained in the End User License Agreement and the Privacy Policy, click the "Next" button in the lower right corner of the interface to enter the driver installation interface.
5. For Windows, follow Step 6. For macOS, enter PC password before proceeding to Step 6.
6. Click on "One-click installation" button under Wi-Fi to install the driver.

Welcome to the Pantum product ,please install the driver by follow steps

1 Power on

2 Select the way of connection

If the button dispalys "Disconnected". please click on  to see the video, it will show you how to connect

 <p>Way 1: Connect with USB</p> <p>Disconnected</p>	 <p>Way 2: Connect with wireline network</p> <p>Disconnected</p>	 <p>Way 3: Connect with Wi-Fi</p> <p>One-click installation</p>
---	--	---

Tips: If the one-click installation does not satisfy your usage scenario, you can try  [manual installation](#)

[User Guide](#)



Note:• You can put your mouse cursor in the "One-click installation" button to check the popup information in order to confirm if the current printer is the one you need to install through IP address before you click the button.

- You can check the printer IP address through "Network configuration page" (Please see [Section 8.1.1.3](#) for how to print)

• If the Install Tool finds only one printer, the setup will start when you click on "One-click installation" under Wi-Fi. The setup may take a while, depending on your PC configuration. Please wait.

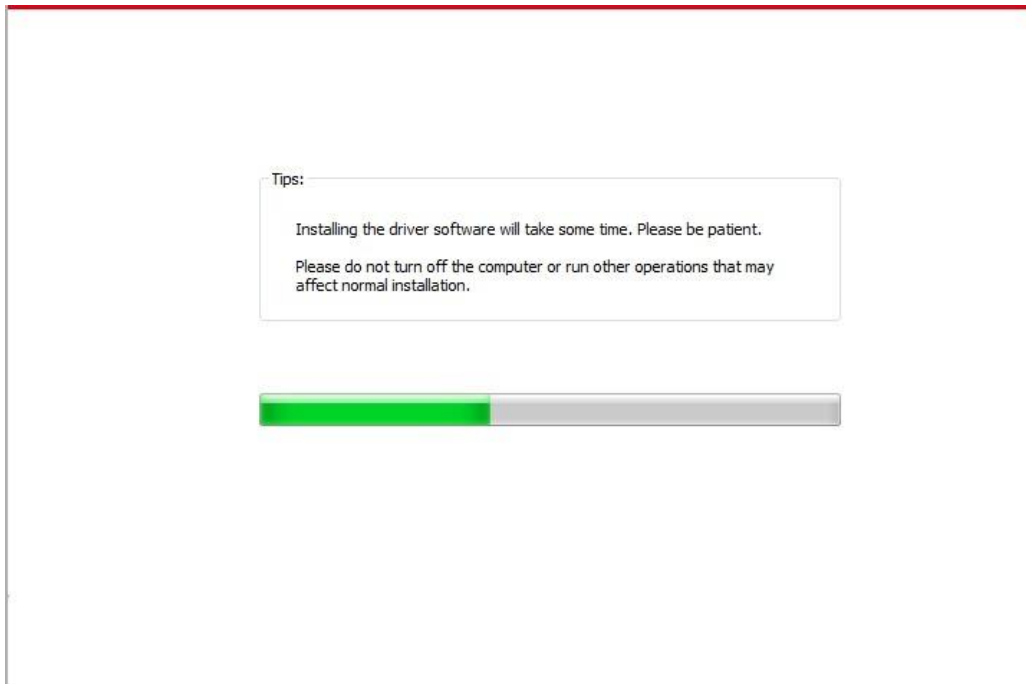

• If the Install Tool finds more than one printer, a printer list will pop up. Please select the printer you desire based on the IP Address of the wireless network for your printer or the Host Name.

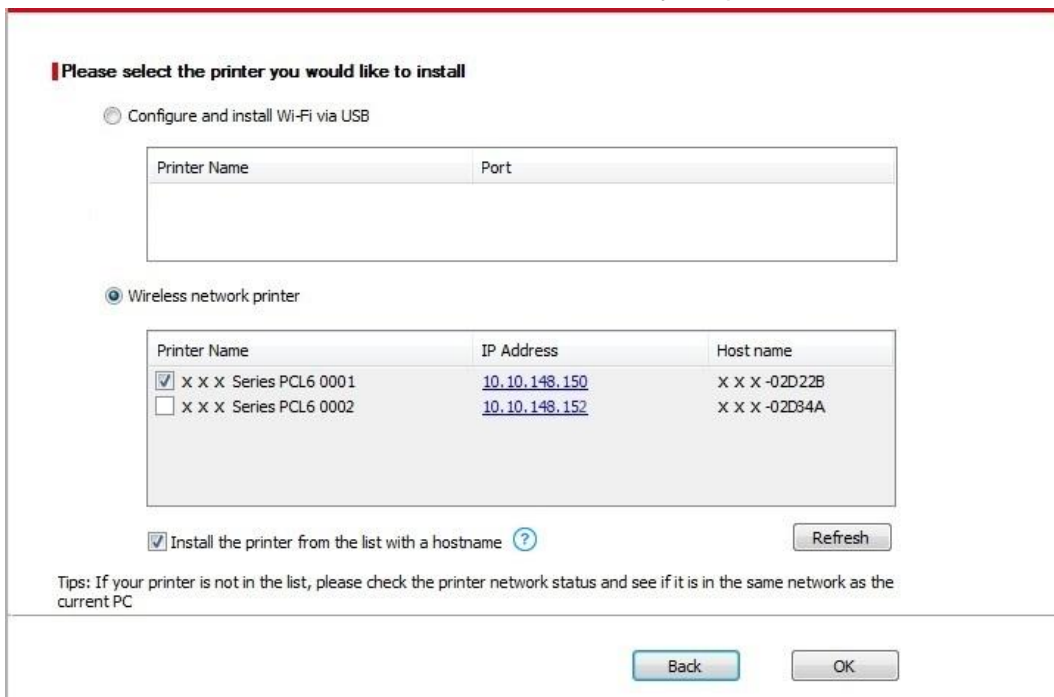



Note: • If the printer you need is not shown in the list, please click "Refresh" button to search again. If it is not found, please check if the printer and computer are in the same network. (Please see [Section 5.3](#) for how to check).

- When the printer IP address changes under printer driver installed with host ID, you can also directly print without re-installing the driver. If you need to install the printer driver with the host ID, please check the option "Install the printer in the list with host ID".

7. After the installation, click "Print & Test Page" button. If your printer prints the test page successfully, it means that you have installed the driver correctly.

3.1.1.2. Connect printer via USB cable

1. Connect the printer to computer via USB cable, power the printer and computer on.

2. Place the attached installation CD in the computer CD-ROM:

For Windows:

- Windows XP system: automatically run the installation procedure.
- Windows 7/Vista/Server 2008 system: Pop up "Autoplay" interface, click "Setup.exe" to run the installation procedure.
- Windows 8 system: When the "DVD RW driver" window pops up from the right top corner of computer desktop, click anywhere in the pop-up window, then click "Setup.exe" to run the installation procedure.
- Windows 10/11 system: When the "DVD RW driver" window pops up from the right top corner of computer desktop, click anywhere in the window, then click "Setup.exe" to run the installation procedure.



Note: • Some computers may be unable to auto play the CD because of system configuration. Please double click "Computer" icon, find "DVD RW driver", then double click "DVD RW driver" to run the installation procedure.

For macOS:

- Double-click on "XXX Series_Mac_Driver" - "Install Tool". (The XXX in XXX Series refers to product model.)
3. Read and agree to the terms contained in the End User License Agreement and the Privacy Policy, click the "Next" button in the lower right corner of the interface to enter the driver installation interface.
4. For Windows, follow Step 5. For macOS, enter PC password before proceeding to Step 5.

5. The setup will start when you click on "One-click installation" under USB. The setup may take a while, depending on your PC configuration. Please wait.

Welcome to the product ,please install the driver by follow steps

- 1** Power on
- 2** Select the way of connection

If the button dispalys "Disconnected", please click on  to see the video, it will show you how to connect



Way 1: Connect with USB

One-dick installation



Way 2: Connect with wireline network

Disconnected



Way 3: Connect with Wi-Fi

Disconnected

Tips: If the one-dick installation does not satisfy your usage scenario, you can try  [manual installation](#)

[User Guide](#)

Tips:

Installing the driver software will take some time. Please be patient.

Please do not turn off the computer or run other operations that may affect normal installation.



6. After the installation, click "Print &Test Page" button. If your printer prints the test page successfully, it means that you have installed the driver correctly.

3.1.1.3. Connect printer via wired network (**Not available for current model now**)

1. Turn the power of printer and computer on.
2. Connect the computer to wired network.
3. Connect network cable to the network interface of printer, to make sure the printer is connected to computer network (please refer to [Section 4](#) for network setup).
4. Place the attached installation CD in the computer CD-ROM:

For Windows:

- Windows XP system: automatically run the installation procedure.
- Windows 7/Vista/Server 2008 system: Pop up "Autoplay" interface, click "Setup.exe" to run the installation procedure.
- Windows 8 system: When the "DVD RW driver" window pops up from the right top corner of computer desktop, click anywhere in the pop-up window, then click "Setup.exe" to run the installation procedure.
- Windows 10/11 system: When the "DVD RW driver" window pops up from the right top corner of computer desktop, click anywhere in the window, then click "Setup.exe" to run the installation procedure.

 **Note:** Some computers may be unable to auto play the CD because of system configuration. Please double click "Computer" icon, find "DVD RW driver", then double click "DVD RW driver" to run the installation procedure.

For macOS:

- Double-click on "XXX Series_Mac_Driver" - "Install Tool". (The XXX in XXX Series refers to product model.)
5. Read and agree to the terms contained in the End User License Agreement and the Privacy Policy, click the "Next" button in the lower right corner of the interface to enter the driver installation interface.
 6. For Windows, follow Step 7. For macOS, enter PC password before proceeding to Step 7.
 7. Click on "One-click installation" button under Wired Network to install the driver.

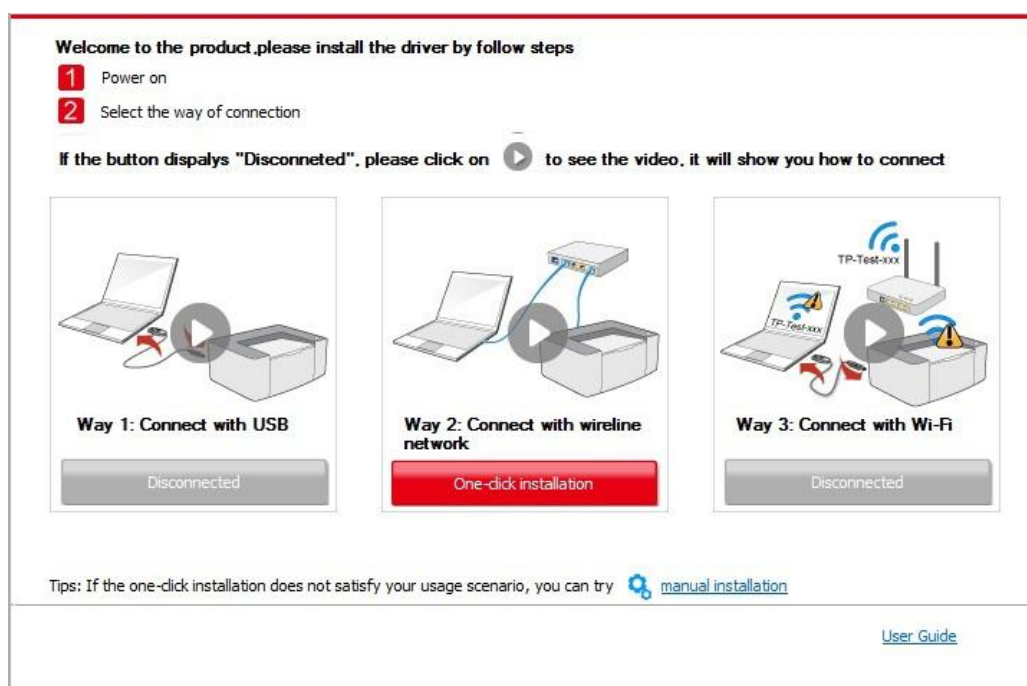



Note:• You can put your mouse cursor in the "One-click installation" button to check the popup information in order to confirm if the current printer is the one you need to install through IP address before you click the button.

- You can check the printer IP address through "Network configuration page" (Please see [Section 8.1.1.3](#) for how to print)

- If the Install Tool finds only one printer, the setup will start when you click on "One-click installation" under Wired Network. The setup may take a while, depending on your PC configuration. Please wait.

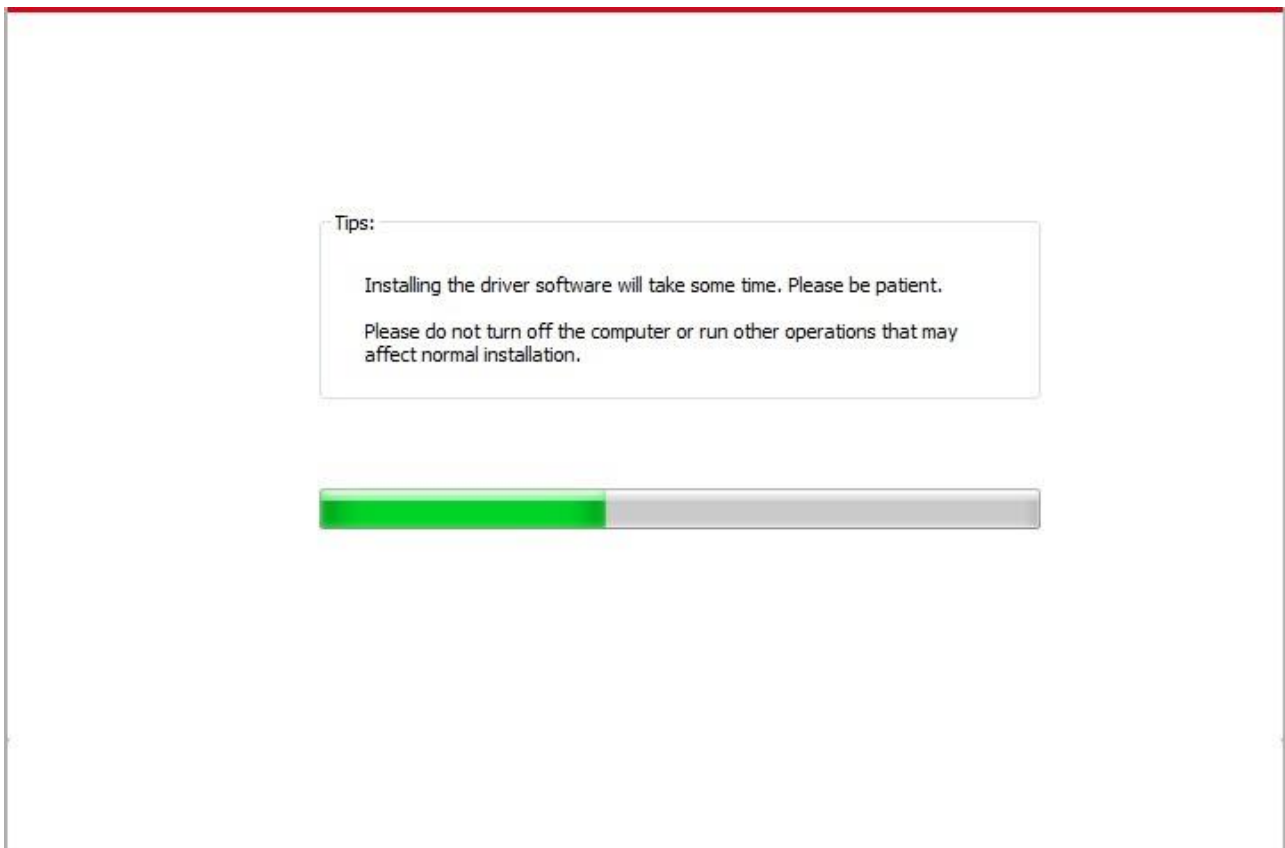

- If the Install Tool finds more than one printer, a printer list will pop up when you click on "One-click installation" under Wired Network. Please select the printer you desire based on the IP Address of the wired network for your printer or the Host Name.

Please select the printer you would like to install

Configure and install Wi-Fi via USB

Printer Name	Port

Wireline network printer

Printer Name	IP Address	Host name
<input checked="" type="checkbox"/> X X X Series PCL6 0001	10.10.148.119	X X X -04B2E7
<input type="checkbox"/> X X X Series PCL6 0002	10.10.148.155	X X X -04B304

Install the printer from the list with a hostname 

Tips: If your printer is not in the list, please check the printer network status and see if it is in the same network as the current PC



Note: If the printer you need is not shown in the list, please click "Refresh" button to search again. If it is not found, please check if the printer and computer are in the same network. (Please see [Section 5.3](#) for how to check).

- When the printer IP address changes under printer driver installed with host ID , you can also directly print without re-installing the driver. If you need to install the printer driver with the host ID, please check the option "Install the printer in the list with host ID".

8. After the installation, click "Print & Test Page" button. If your printer prints the test page successfully, it means that you have installed the driver correctly.

3.1.2. More setup methods

3.1.2.1. More setup methods for Windows

- Before installing the drive, you need to learn about printer model by printing printer information page out and check the product name (please refer to [Section 8.1.1.3](#) for printing methods).

3.1.2.1.1. Installation via USB connection

1. Connect the printer to computer via USB cable, power the printer and computer on.
2. Place the attached installation CD in the computer CD-ROM:
 - Windows XP system: automatically run the installation procedure.
 - Windows 7/Vista/Server 2008 system: Pop up "Autoplay" interface, click "Setup.exe" to run the installation procedure.
 - Windows 8 system: When the " DVD RW driver" window pops up from the right top corner of computer desktop, click anywhere in the pop-up window, then click "Setup.exe" to run the installation procedure.

- Windows 10/11 system: When the "DVD RW driver" window pops up from the right top corner of computer desktop, click anywhere in the window, then click "Setup.exe" to run the installation procedure.

 **Note:** Some computers may be unable to auto play the CD because of system configuration. Please double click "Computer" icon, find "DVD RW driver", then double click "DVD RW driver" to run the installation procedure.

3. Read and agree to the terms contained in the End User License Agreement and the Privacy Policy, click the "Next" button in the lower right corner of the interface to enter the driver installation interface.
4. Click on "More setup methods" at the bottom of the setup interface for access.
5. Please select installation language and printer model.
6. Select "Connect via USB" and click on "Install".

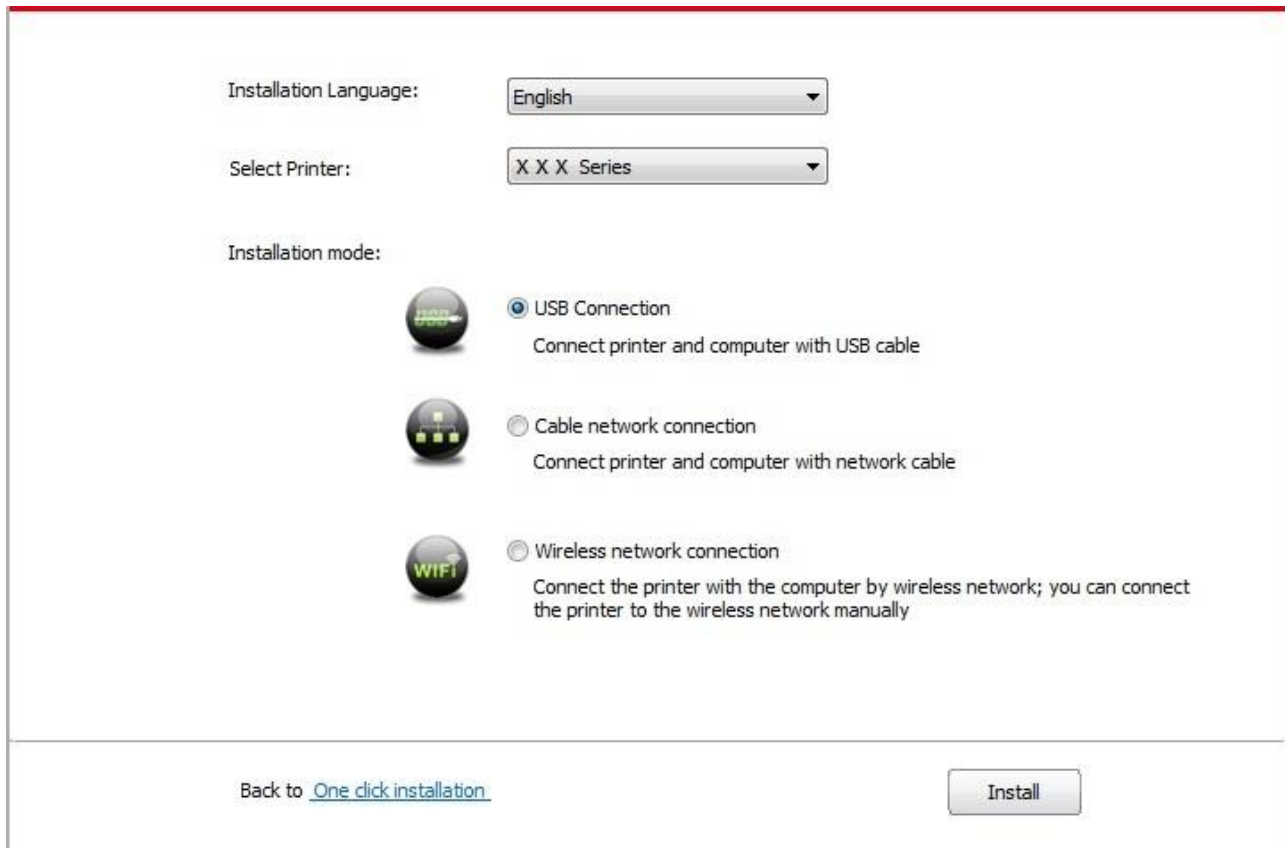

Installation Language: English

Select Printer: X X X Series

Installation mode:

- USB Connection
Connect printer and computer with USB cable
- Cable network connection
Connect printer and computer with network cable
- Wireless network connection
Connect the printer with the computer by wireless network; you can connect the printer to the wireless network manually

Back to [One click installation](#) Install

7. The software installs the driver automatically and the installation process may need some time. The duration is related to your computer configuration, please wait patiently.
8. After the installation, click "Print & Test Page" button. If your printer prints the test page successfully, it means that you have installed the driver correctly.

3.1.2.1.2. Installation via wired network connection (applicable to wired network models)

1. Turn the power of printer and computer on.
2. Connect the computer to wired network.
3. Connect network cable to the network interface of printer, to make sure the printer is connected to computer network (please refer to [Section 4](#) for network setup).

4. Place the attached installation CD in the computer CD-ROM:

- Windows XP system: automatically run the installation procedure.
- Windows 7/Vista/Server 2008 system: Pop up "Autoplay" interface, click "Setup.exe" to run the installation procedure.
- Windows 8 system: When the "DVD RW driver" window pops up from the right top corner of computer desktop, click anywhere in the pop-up window, then click "Setup.exe" to run the installation procedure.
- Windows 10/11 system: When the "DVD RW driver" window pops up from the right top corner of computer desktop, click anywhere in the window, then click "Setup.exe" to run the installation procedure.

 **Note:** • Some computers may be unable to auto play the CD because of system configuration. Please double click "Computer" icon, find "DVD RW driver", then double click "DVD RW driver" to run the installation procedure.

5. Read and agree to the terms contained in the End User License Agreement and the Privacy Policy, click the "Next" button in the lower right corner of the interface to enter the driver installation interface.

6. Click on "More setup methods" at the bottom of the setup interface for access.

7. Please select installation language and printer model.

8. Select "Wireline network connection" and click on "Install".

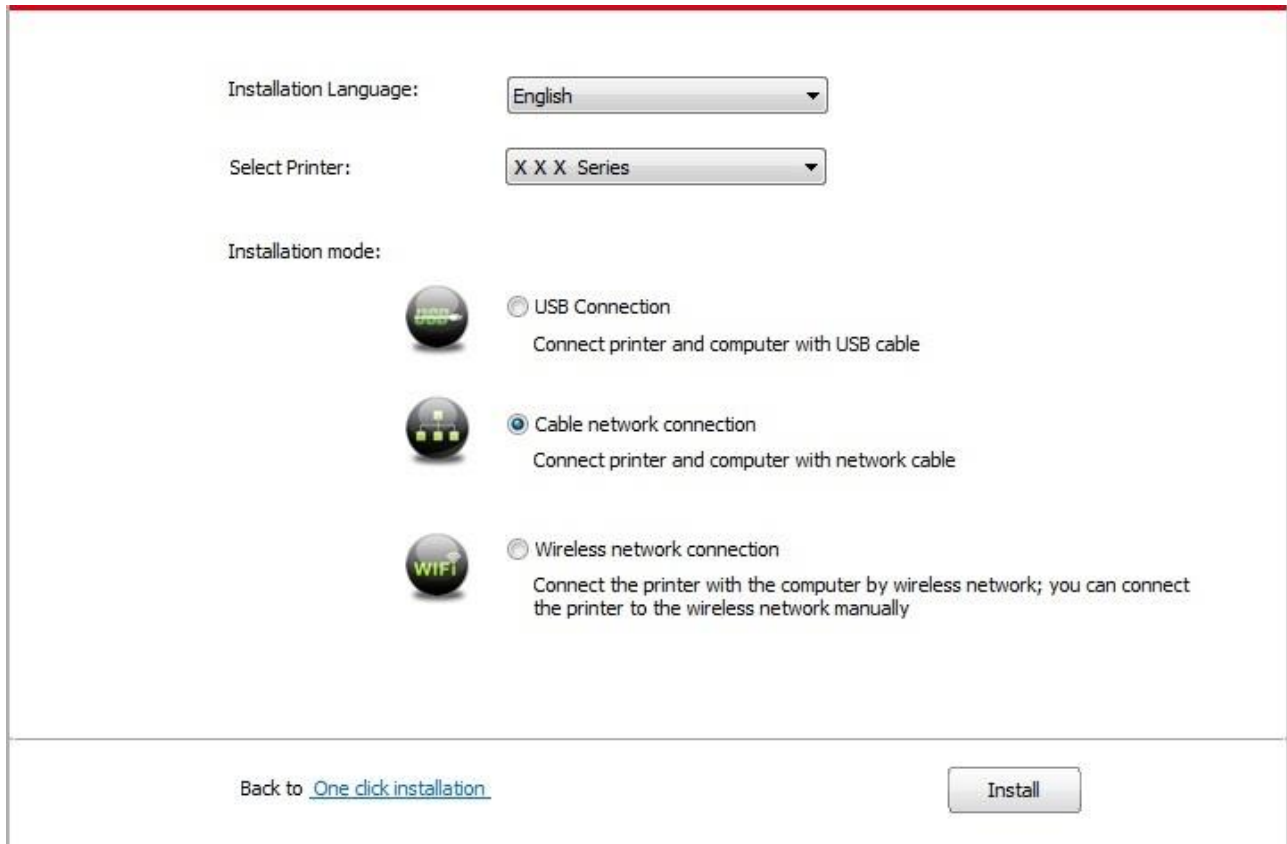

The screenshot displays a printer installation configuration window. It features three main sections: 'Installation Language' with a dropdown menu set to 'English'; 'Select Printer' with a dropdown menu set to 'X X X Series'; and 'Installation mode' with three radio button options. The 'Cable network connection' option is selected. At the bottom, there is a link 'Back to [One click installation](#)' and an 'Install' button.

9. The installation software will search the printer automatically and the searching process may need some time.

10. After finishing searching, select the printer that needs to be connected and click "Next".

Detected Printer

Printer Name	IP Address	Host name
<input checked="" type="checkbox"/> X X X Series PCL6 0001	10.10.148.140	X X X -779BBB

Install the printer from the list with a hostname

Add the IP address or hostname manually



Note: If the printer you need to connect is not in the list of printers searched, please click "Refresh" to search again.

- When the printer IP address changes under printer driver installed with host ID , you can also directly print without re-installing the driver. If you need to install the printer driver with the host ID, please check the option "Install the printer in the list with host ID".
- If IP address or host name is added manually, you need to know the IP address of the printer connected or host name. If they are not made clear, please print the "NetConf Pg" and view "IP Address" and "Host name" (Please refer to [Section 8.1.1.3](#)).

11. The software installs the driver automatically and the installation process may need some time. The duration is related to your computer configuration, please wait patiently.

12. After the installation, click "Print & Test Page" button. If your printer prints the test page successfully, it means that you have installed the driver correctly.

3.1.2.1.3. Installation by wireless network connection mode (applicable to Wi-Fi models)

Wireless network connection type is divided into basic structure mode and Wi-Fi Direct mode (please refer to [Section 5](#) for details).

3.1.2.1.3.1. Installation in basic structure mode

1. Connect computer to access point (wireless router).
2. Connect the printer to computer via USB cable, then power the printer on.
3. Place the attached installation CD in the computer CD-ROM:
 - Windows XP system: automatically run the installation procedure.
 - Windows 7/Vista/Server 2008 system: Pop up "Autoplay" interface, click "Setup.exe" to run the installation procedure.

-
- Windows 8 system: When the "DVD RW driver" window pops up from the right top corner of computer desktop, click anywhere in the pop-up window, then click "Setup.exe" to run the installation procedure.
 - Windows 10/11 system: When the "DVD RW driver" window pops up from the right top corner of computer desktop, click anywhere in the window, then click "Setup.exe" to run the installation procedure.

 **Note:** Some computers may be unable to auto play the CD because of system configuration. Please double click "Computer" icon, find "DVD RW driver", then double click "DVD RW driver" to run the installation procedure.

4. Read and agree to the terms contained in the End User License Agreement and the Privacy Policy, click the "Next" button in the lower right corner of the interface to enter the driver installation interface.
5. Click on "More setup methods" at the bottom of the setup interface for access.
6. Please select installation language and printer model.
7. Select "Wireless network connection" and click on "Install".

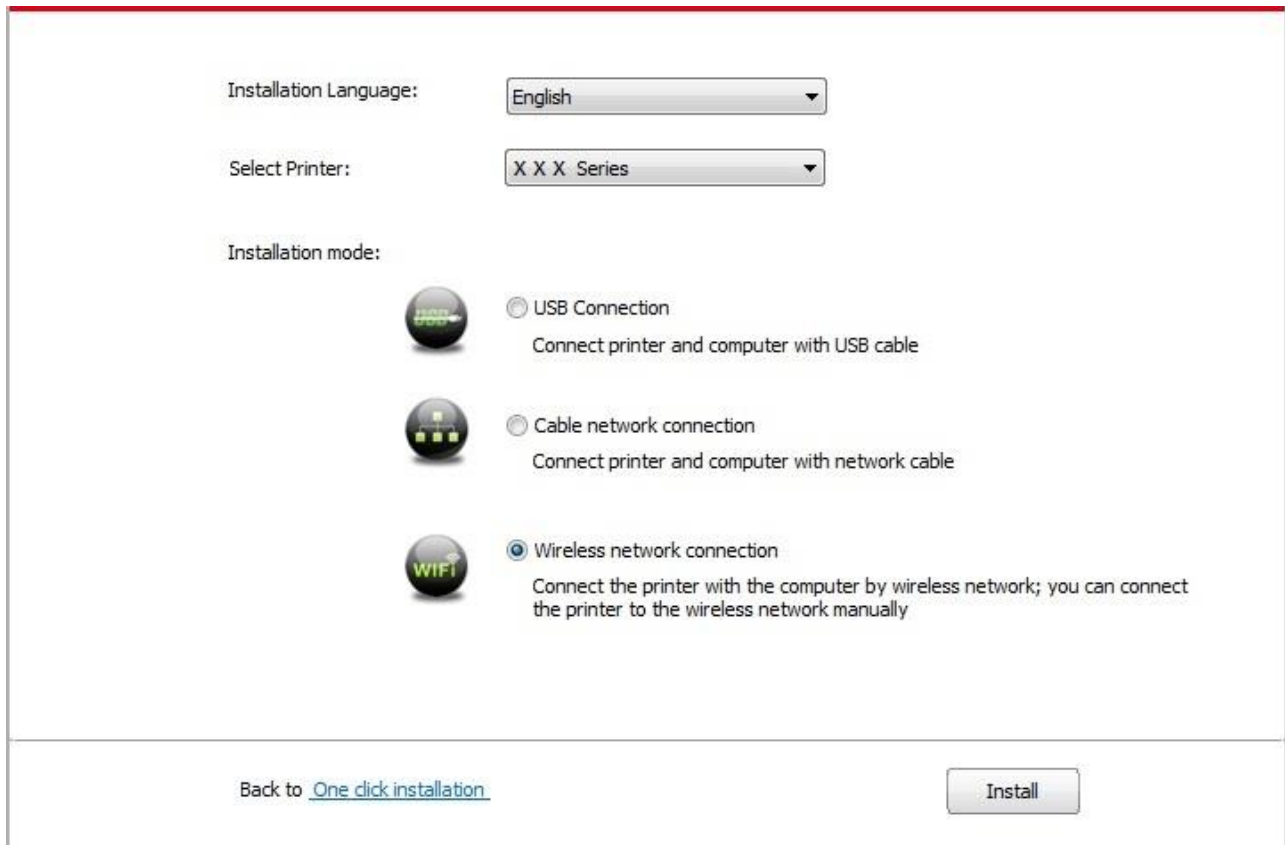

Installation Language: English

Select Printer: X X X Series

Installation mode:

- USB Connection
Connect printer and computer with USB cable
- Cable network connection
Connect printer and computer with network cable
- Wireless network connection
Connect the printer with the computer by wireless network; you can connect the printer to the wireless network manually

[Back to One click installation](#)

8. Select “Yes, I want to configurate the printer's wireless network” on the wireless setup window popped out, and operate according to the prompts to set up the printer to wireless network (please refer to [Section 5.1.1](#) for setup method).

The installation program will determine whether wireless network of the printer is to be configured based on your choice in this step;

- if you need to configure or change wireless network of the printer, please select “yes” after the printer connects USB;
- if not, please select “no”.

Yes, I want to configurate the printer's wireless network.

No, the printer has been connected to wireless network.

Previous Next Exit

9. The installation software will search the printer automatically after wireless network is configured successfully. The search process may need some time.

10. Select the printer needs to be connected and click “Next”.

Detected Printer

Printer Name	IP Address	Host name
<input checked="" type="checkbox"/> X X X Series PCL6 0001	10.10.148.140	X X X -779BBB

Install the printer from the list with a hostname

Add the IP address or hostname manually

Previous Next Exit



Note:• If the printer you need to connect is not in the list of printers searched, please click “Refresh” to search again.

- When the printer IP address changes under printer driver installed with host ID , you can also directly print without re-installing the driver. If you need to install the printer driver with the host ID, please check the option "Install the printer in the list with host ID".
 - If IP address or host name is added manually, you need to know the IP address of the printer connected or host name. If they are not made clear, please print the “NetConf Pg” and view “IP Address” and “Host name” (Please refer to [Section 8.1.1.3](#)).
-

11. The software installs the driver automatically and the installation process may need some time. The duration is related to your computer configuration, please wait patiently.
12. After the installation, click "Print &Test Page" button. If your printer prints the test page successfully, it means that you have installed the driver correctly.

3.1.2.1.3.2. Installation in Wi-Fi Direct mode

1. Turn the power of printer and computer on.
2. Connect computer to the Wi-Fi Direct network of the printer (please refer to [Section 5.2.2](#) for setup method).
3. Place the attached installation CD in the computer CD-ROM:
 - Windows XP system: automatically run the installation procedure.
 - Windows 7/Vista/Server 2008 system: Pop up "Autoplay" interface, click “Setup.exe” to run the installation procedure.
 - Windows 8 system: When the " DVD RW driver" window pops up from the right top corner of computer desktop, click anywhere in the pop-up window, then click "Setup.exe" to run the installation procedure.
 - Windows 10/11 system: When the "DVD RW driver" window pops up from the right top corner of computer desktop, click anywhere in the window, then click "Setup.exe" to run the installation procedure.



Note:• Some computers may be unable to auto play the CD because of system configuration. Please double click "Computer" icon, find "DVD RW driver", then double click "DVD RW driver" to run the installation procedure.

4. Read and agree to the terms contained in the End User License Agreement and the Privacy Policy, click the “Next” button in the lower right corner of the interface to enter the driver installation interface.
5. Click on “More setup methods” at the bottom of the setup interface for access.
6. Please select installation language and printer model.
7. Select "Wireless network connection" and click on "Install".

Installation Language:

Select Printer:

Installation mode:

- USB Connection
Connect printer and computer with USB cable
- Cable network connection
Connect printer and computer with network cable
- Wireless network connection
Connect the printer with the computer by wireless network; you can connect the printer to the wireless network manually

[Back to One click installation](#)

8. Select “No, the printer has been connected to wireless network” on the wireless setup window popping out, and then click “Next”.

The installation program will determine whether wireless network of the printer is to be configured based on your choice in this step;

- if you need to configure or change wireless network of the printer, please select “yes” after the printer connects USB;
- if not, please select “no”.

Yes, I want to configurate the printer's wireless network.

No, the printer has been connected to wireless network.

- The installation software will search the printer automatically and the searching process may need some time.
- Select the printer needs to be connected and click "Next".

Detected Printer

Printer Name	IP Address	Host name
<input checked="" type="checkbox"/> X X X Series PCL6 0001	10.10.148.140	X X X -779BBB

Install the printer from the list with a hostname

Add the IP address or hostname manually

 **Note:** If the printer you need to connect is not in the list of printers searched, please click "Refresh" to search again.

- When the printer IP address changes under printer driver installed with host ID , you can also directly print without re-installing the driver. If you need to install the printer driver with the host ID, please check the option "Install the printer in the list with host ID".
- If IP address or host name is added manually, you need to know the IP address of the printer connected or host name. If they are not made clear, please print the "NetConf Pg" and view "IP Address" and "Host name" (Please refer to [Section 8.1.1.3](#)).

- The software installs the driver automatically and the installation process may need some time. The duration is related to your computer configuration, please wait patiently.
- After the installation, click "Print & Test Page" button. If your printer prints the test page successfully, it means that you have installed the driver correctly.

3.1.2.2. More setup methods for macOS

3.1.2.2.1. Install via USB cable

macOS 10.14 is taken as the example in the following operation. The information on your computer screen may differ because of multiple operating systems.

- Turn the power of printer and computer on.
- Insert the setup CD supplied in the CD-ROM of the PC, and double-click on "XXX Series_Mac_Driver" – "Install Tool". (The XXX in XXX Series refers to product model.)

3. Read and agree to the terms contained in the End User License Agreement and the Privacy Policy, click the “Next” button in the lower right corner of the interface to enter the driver installation interface.

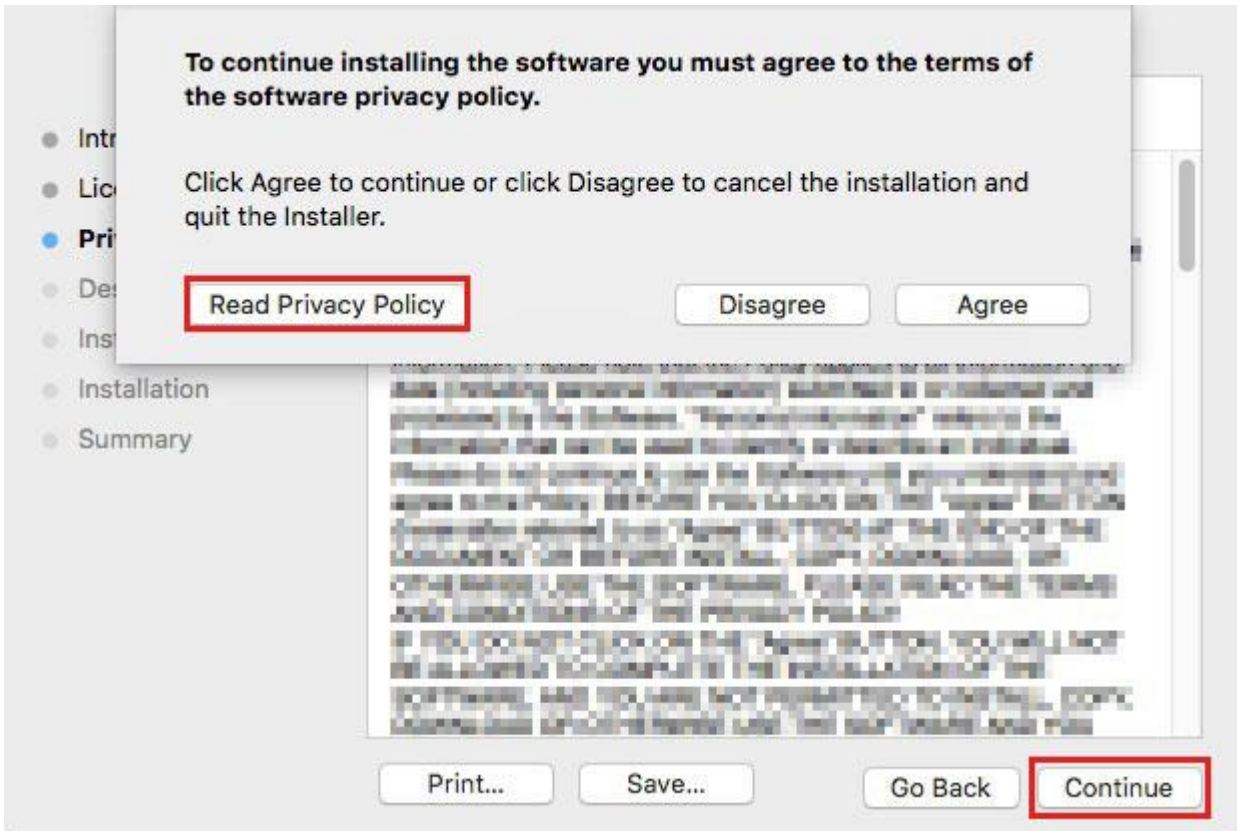

4. Enter the password of the PC, and click on “Install Software”.

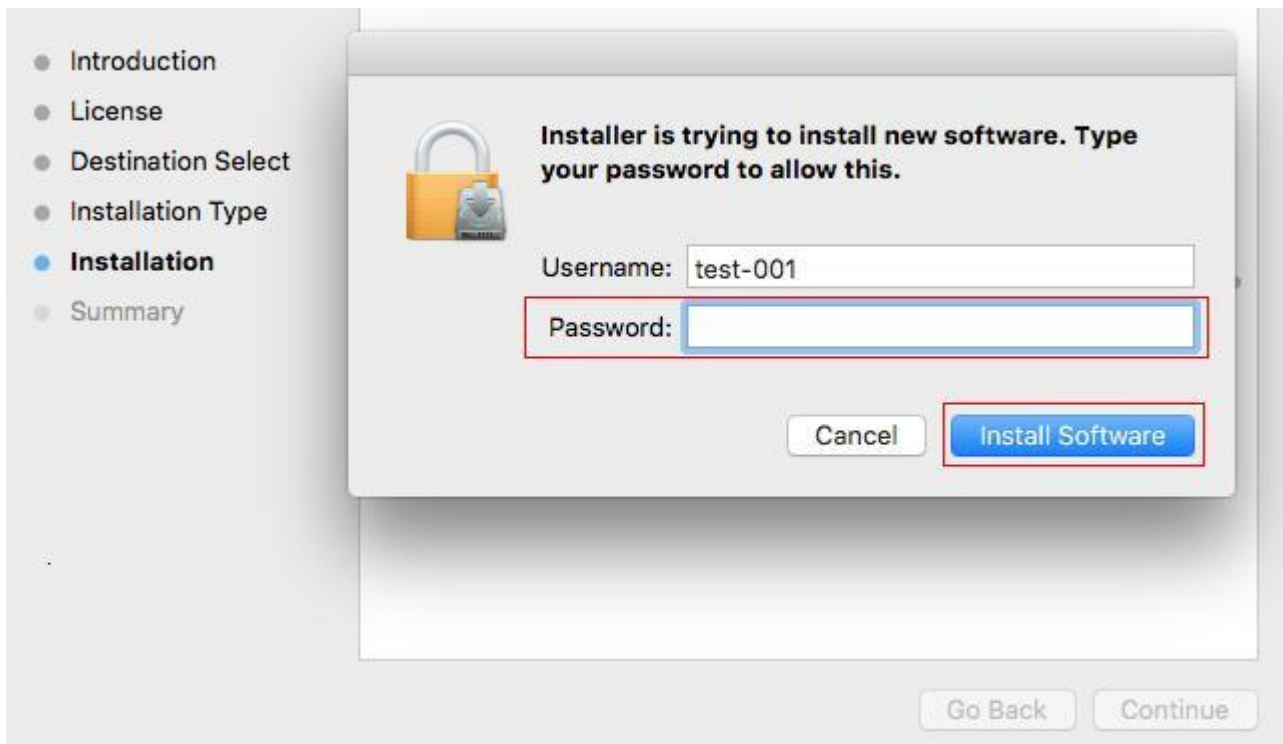

5. Click on “More setup methods” at the bottom of the setup interface for access.

6. Select a USB printer from the search results.

Please select the printer you would like to install

USB printer

Printer Name	Serial number
<input checked="" type="checkbox"/> xxx series	AA2A000000

Web printer

Printer Name	IP Address	Host name

Refresh

Host name or IP address

[Off-line installation](#)

Back

Install

7. Click on "Install" on the lower right.
8. The software installs the driver automatically and the installation process may need some time. The duration is related to your computer configuration, please wait patiently.
9. After the installation, click "Print & Test Page" button. If your printer prints the test page successfully, it means that you have installed the driver correctly.

3.1.2.2.2. Install as a network printer

1. Turn the power of printer and computer on.
2. Connect the PC to the network.
3. Make sure the printer is connected to the same network as the PC (See [Section 4](#) or [5](#) to learn how to configure the network).
4. Insert the setup CD supplied in the CD-ROM of the PC, and double-click on "XXX Series_Mac_Driver" – "Install Tool". (The XXX in XXX Series refers to product model.)
5. Read and agree to the terms contained in the End User License Agreement and the Privacy Policy, click the "Next" button in the lower right corner of the interface to enter the driver installation interface.
6. Enter the password of the PC, and click on "Install Software".

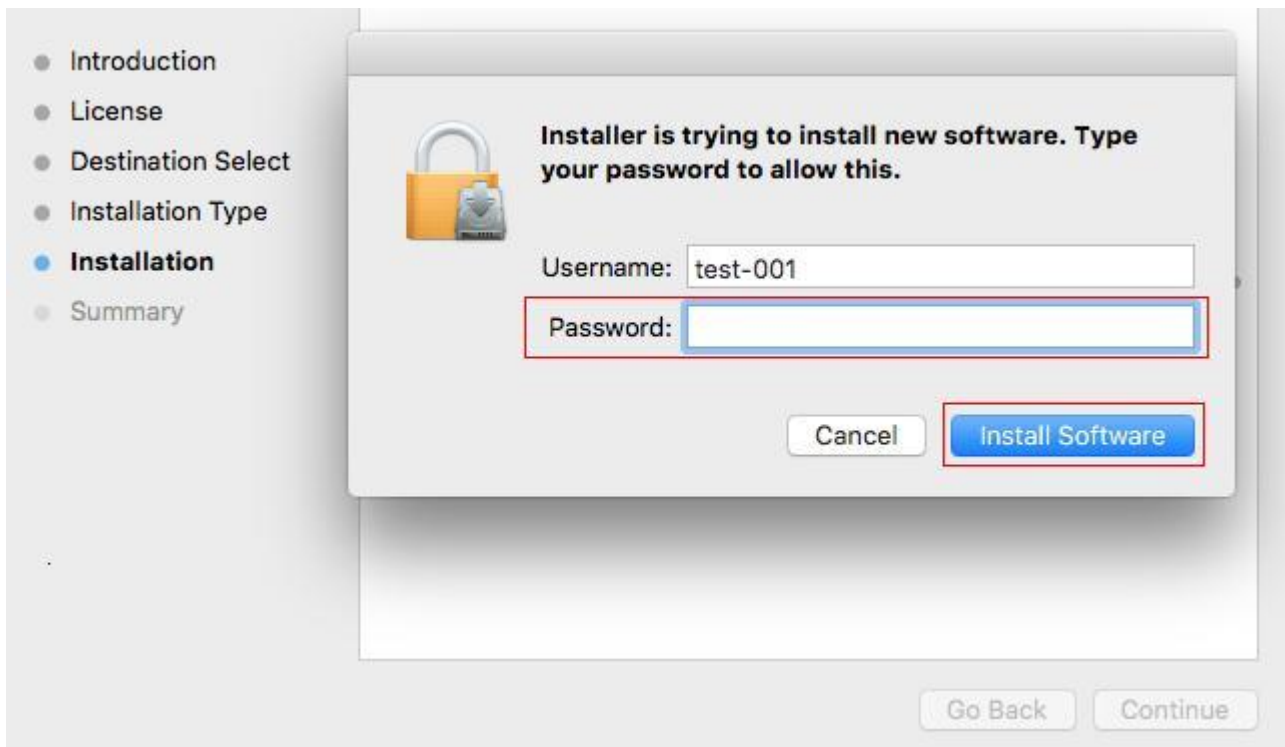

7. Click on “More setup methods” at the bottom of the setup interface for access.
8. Select a network printer from the search results.
9. Click on “Install” on the lower right.

Please select the printer you would like to install

USB printer

Printer Name	Serial number
--------------	---------------

Web printer

Printer Name	IP Address	Host name
<input checked="" type="checkbox"/> xxx Series A4B5D3	10.10.134.93	xxx-A4B5D3
<input type="checkbox"/> xxx Series A4B5D3	10.10.134.55	xxx-A4B5D3

Host name or IP address

[Off-line installation](#)

 **Note:** If the printer you need to connect is not in the list of printers searched, please click “Refresh” to search again.

-
- When the printer IP address changes under printer driver installed with host ID , you can also directly print without re-installing the driver. If you need to install the printer driver with the host ID, please check the option "Install the printer in the list with host ID".
 - If IP address or host name is added manually, you need to know the IP address of the printer connected or host name. If they are not made clear, please print the "NetConf Pg" and view "IP Address" and "Host name" (Please refer to [Section 8.1.1.3](#)).
-

10. The software installs the driver automatically and the installation process may need some time. The duration is related to your computer configuration, please wait patiently.

11. After the installation, click "Print & Test Page" button. If your printer prints the test page successfully, it means that you have installed the driver correctly.

3.1.2.2.3. Install via Host Name or IP Address

1. Turn the power of printer and computer on.
2. Connect the PC to the network.
3. Make sure the printer is connected to the same network as the PC (See [Section 4](#) or [5](#) to learn how to configure the network).
4. Insert the setup CD supplied in the CD-ROM of the PC, and double-click on "XXX Series_Mac_Driver" – "Install Tool". (The XXX in XXX Series refers to product model.)
5. Read and agree to the terms contained in the End User License Agreement and the Privacy Policy, click the "Next" button in the lower right corner of the interface to enter the driver installation interface.
6. Enter the password of the PC, and click on "Install Software".

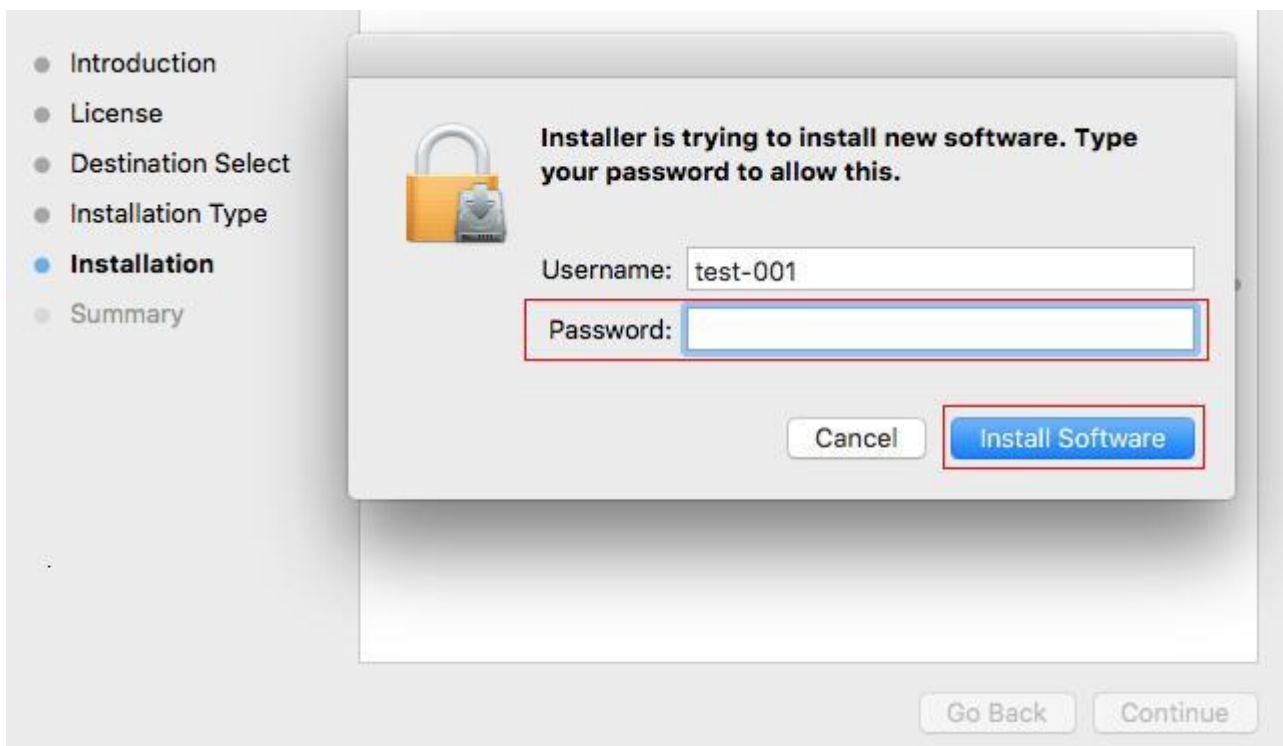

7. Click on "More setup methods" at the bottom of the setup interface for access.

8. Select Host Name or IP Address, and enter the Host Name or IP address of the printer you wish to add.

9. Click on “Install” on the lower right.

Please select the printer you would like to install

USB printer

Printer Name	Serial number	

Web printer

Printer Name	IP Address	Host name	

Host name or IP address

Valid and complete host name or address.

[Off-line installation](#)

 **Note:** • If the printer you need to connect is not in the list of printers searched, please click “Refresh” to search again.

- When the printer IP address changes under printer driver installed with host ID , you can also directly print without re-installing the driver. If you need to install the printer driver with the host ID, please check the option "Install the printer in the list with host ID".
- If IP address or host name is added manually, you need to know the IP address of the printer connected or host name. If they are not made clear, please print the “NetConf Pg” and view “IP Address” and “Host name” (Please refer to [Section 8.1.1.3](#)).

10. The software installs the driver automatically and the installation process may need some time. The duration is related to your computer configuration, please wait patiently.

11. After the installation, click "Print & Test Page" button. If your printer prints the test page successfully, it means that you have installed the driver correctly.

3.1.2.2.4. Off-line Install

1. Turn the power of printer and computer on.
2. Insert the setup CD supplied in the CD-ROM of the PC, and double-click on "XXX Series_Mac_Driver" – "Install Tool". (The XXX in XXX Series refers to product model.)
3. Read and agree to the terms contained in the End User License Agreement and the Privacy Policy, click the “Next” button in the lower right corner of the interface to enter the driver installation interface.
4. Enter the password of the PC, and click on “Install Software”.

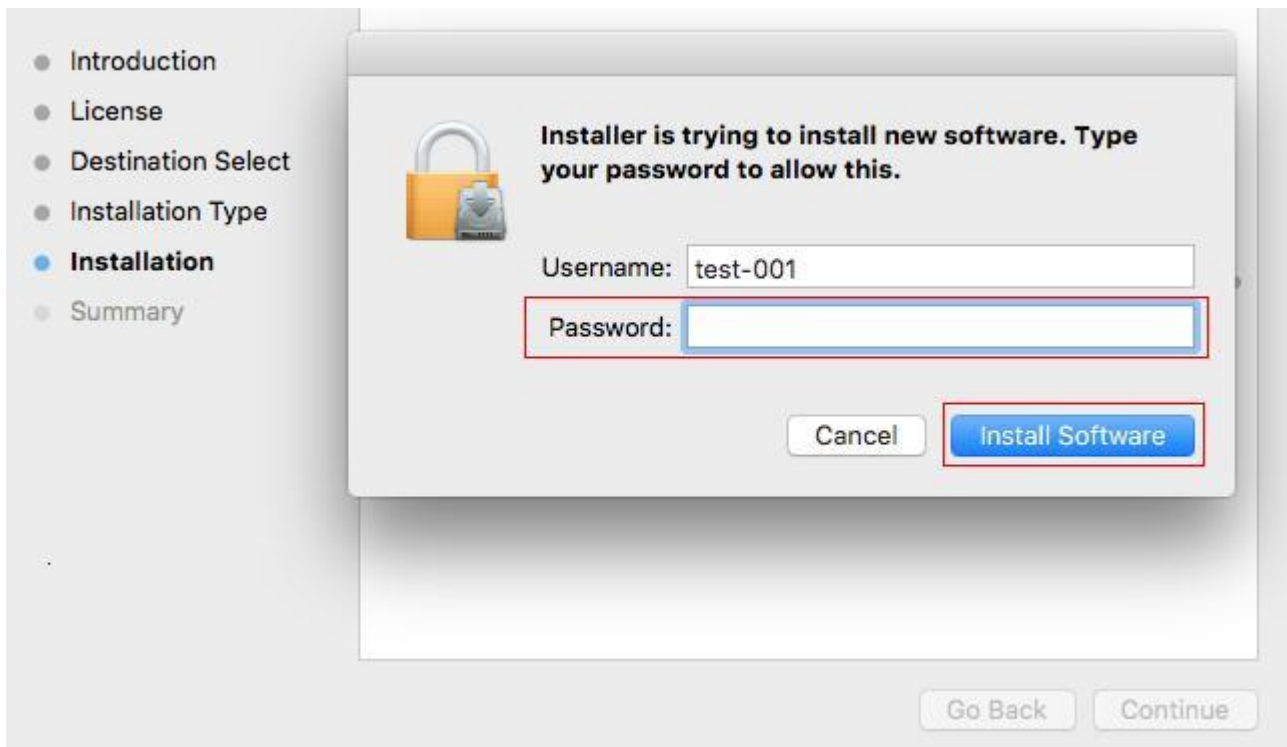

5. Click on "More setup methods" at the bottom of the setup interface for access.
6. Click on "Off-line installation" on the lower left.

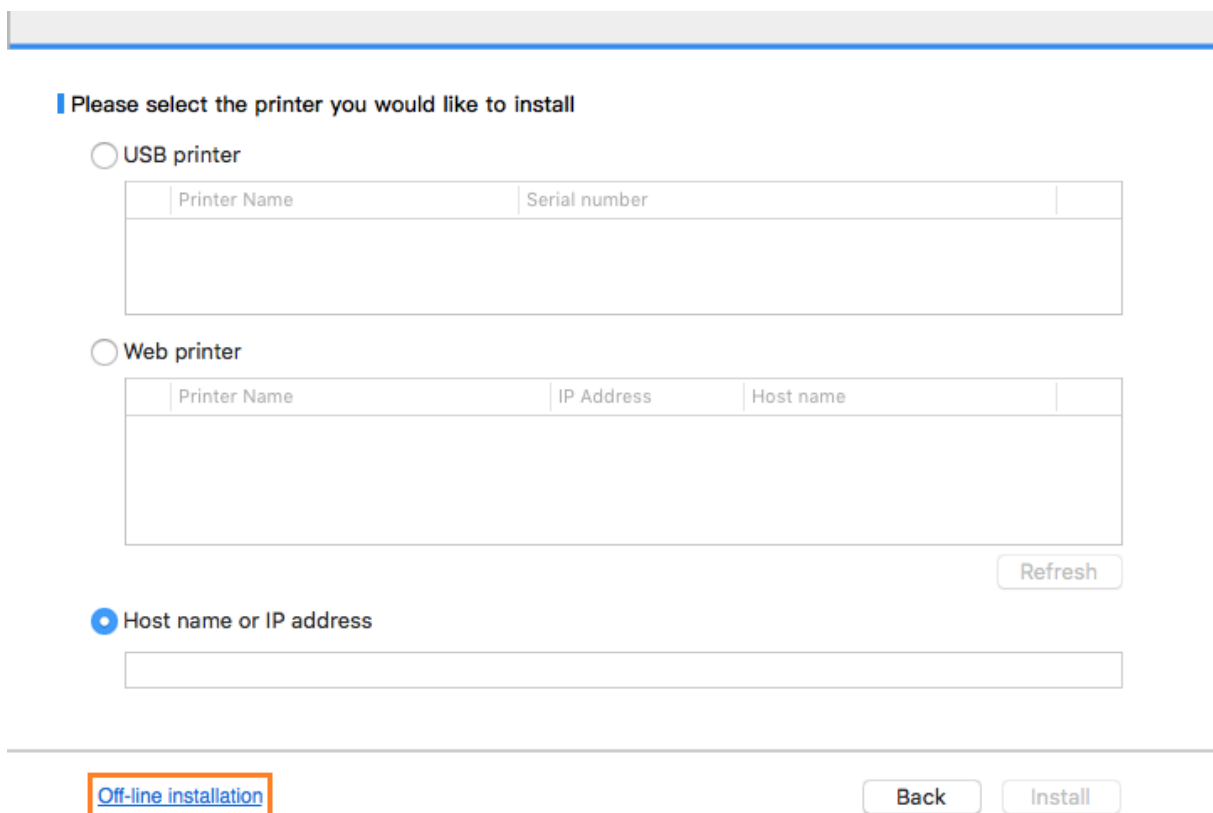

7. The software installs the driver automatically and the installation process may need some time. The duration is related to your computer configuration, please wait patiently.

8. Install complete. Please finish printer adding as guided or refer to [Section 3.1.2.2.4.1](#).

3.1.2.2.4.1. Add printer to macOS system

I. Add up the printer via USB

1. Connect the printer to computer with USB cable and then turn power on.
2. Enter the “System Preferences” – “Printers & Scanners” of computer.
3. Click  button to select “Add Printer or Scanner”.
4. Select printer and then select the corresponding printer mode from the “Use” menu popping out.
5. Click “Add”.

II. Add up the printer via wireline connection (applicable to wired network models)

1. Turn the power of printer and computer on.
2. Connect the computer to wired network.
3. Connect the network cable to the network interface of printer, and make sure the printer is connected to the computer network (Please refer to [Section 4](#) for network setup).
4. Enter the “System Preferences” – “Printers & Scanners” of computer.
5. Click  button to select “Add Printer or Scanner”.
6. Select printer and then select the corresponding printer mode from the “Use” menu popping out.
7. Click “Add”.

III. Add up the printer via wireless connection (applicable to Wi-Fi models)

1. Turn the power of printer and computer on.
2. Make sure the wireless network connection between computer and printer is set up.



Note: • In case of basic structure mode, connect wireless network printer to the access point (wireless router). Please refer to [Section 5.1](#) for connection method.
• In case of Wi-Fi Direct mode, connect wireless client to wireless network printer directly. Please refer to [Section 5.2](#) for connection methods.

3. Enter the “System Preferences” – “Printers & Scanners” of computer.
4. Click  button to select “Add Printer or Scanner”.
5. Select printer and then select the corresponding printer mode from the “Use” menu popping out.
6. Click “Add”.

3.2. Uninstall Driver

3.2.1. Method to uninstall driver under Windows

Windows 7 is taken as the example in the following operation. The information on your computer screen may differ because of multiple operating systems.

1. Click the Start menu of computer and then click All programs.
2. Click Printer, and then Click XXX Series.
XXX Series where XXX represents product model.
3. Click uninstall to delete the driver according to instructions on uninstall window.
4. Restart computer after finishing unloading.

3.2.2. Method to uninstall driver under macOS

macOS10.14 is taken as the example in the following operation. The information on your computer screen may differ because of multiple operating systems.

1. Click "Go" - "Applications" - "Printer" - "Utilities" - "Un-install Tool".
2. Delete the driver as instructed in the pop-up Uninstall window.
3. Uninstall complete.

4. Wired Network Settings (For wired network printer models)

You may need to set some network parameters on the printer. These parameters can be set from the embedded Web server.



Note: • Due to printer upgrades, some functions may be different, depending on the model you purchased. If you have any questions, please contact G&G Customer Service.

4.1. Set IP Address

The IP address of the printer may be automatically obtained through DHCP function or set manually.

| Automatic Setting

DHCP automatic setting function is enabled by default on the printer.

1. Connect the printer to the network through a network cable and complete the startup preparation work.
2. The printer will automatically obtain the IP address assigned by the server. The IP address obtained automatically can be used after a few minutes.



Note: • If DHCP cannot automatically obtain the IP address, the printer will automatically use the default IP address: 169.254.xx.xx.

- Due to the features of DHCP, the IP address of the printer automatically assigned by the network may vary if the printer has not been used for a long time or the network access point changes, which could result in unsuccessful connection to the printer. It is recommended that the IP address automatically assigned by the network is bound to the Mac address of the printer while the DHCP function is enabled.
-

| Manual Setting

Type the IP address in the Web browser's address bar to open the embedded Web server.

1. Click Settings in the navigation bar to open the Settings page;
2. Select Network Settings - IPV4 Settings;
3. Set IP Address Assignment Mode (Manual), IP Address and Subnet Mask. Other items are optional;
4. Click Apply to save the settings.



Note: • You can use the embedded Web server to change the IP Address Assignment Mode into Automatic or Manual.

4.2. Install the Printer to Network

In this setting, the printer is directly connected to the network and can be set to allow all computers on the network to print directly on the printer.

1. Before starting the printer, first connect the network cable to the network port of the printer to establish direct connection to the network.
2. Start the printer and wait until the status indicator on the control panel displays Ready status, as shown below.



3. Insert the printer CD into the computer. If the software installer does not start, browse to the "setup.exe" file on the CD, and double-click to run the file.
4. Follow the operation instructions of the installer.
5. Continue to complete the installation.



Note: • When the installer prompts you to select a printer, you can select the appropriate printer name from the Detected Printer;

- If the printer name does not appear in the Detected Printer, please click Refresh and search for printers on the network;
 - If you know the IP address of the printer to be connected, you can select Specify an IP Address for Installation to enter the IP address for installation.
-

4.3. Setting Network Products

4.3.1. View or Change Network Settings

You can use the embedded Web server to view or change IP settings.

1. Long press the "Cancel/Continue" button on the control panel to print Demo information page, and view the IP address of the printer. Demo page can be printed by long pressing the button on the control panel (as shown in the figure below) in the idle status.
2. Type the IP address in the Web browser's address bar to access the embedded Web server.
3. Click Settings tab to obtain network information. Change the settings as needed.

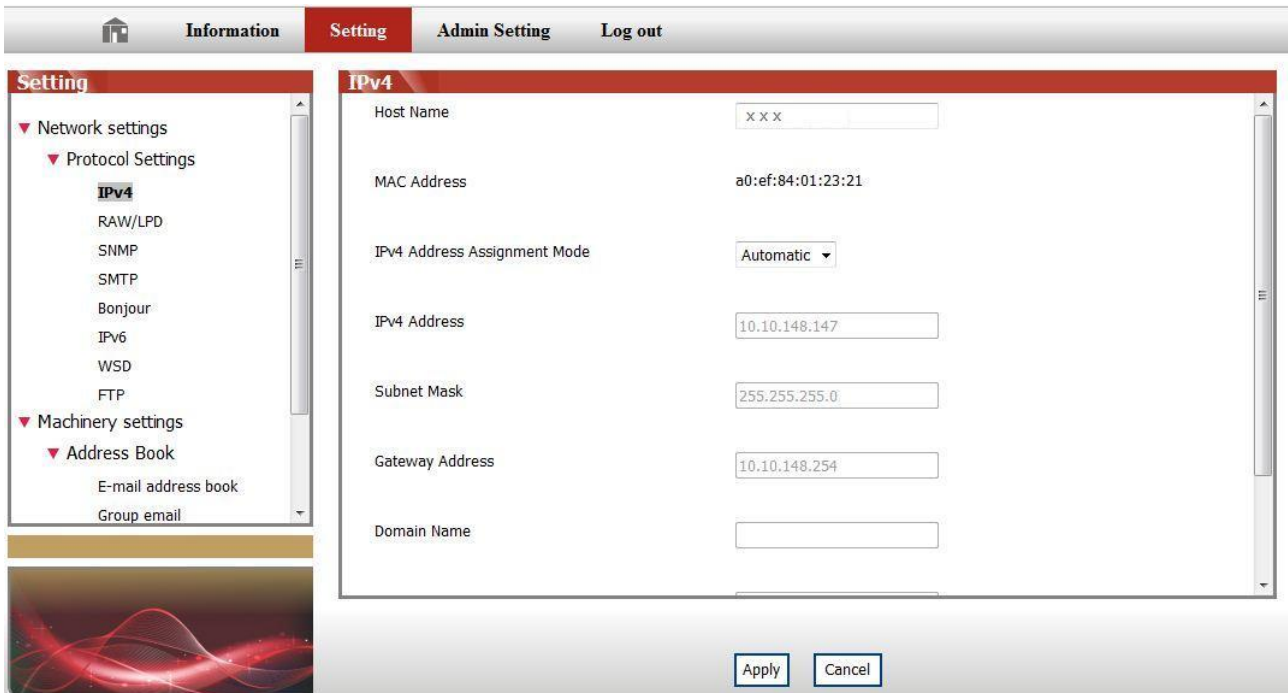

The screenshot displays the printer's embedded Web server interface. At the top, there are navigation tabs: Information, Setting (selected), Admin Setting, and Log out. The main content area is divided into two panels. The left panel, titled 'Setting', contains a tree view with 'Network settings' expanded to show 'Protocol Settings', which includes 'IPv4' (selected), RAW/LPD, SNMP, SMTP, Bonjour, IPv6, WSD, and FTP. Below this are 'Machinery settings' and 'Address Book' (with sub-items 'E-mail address book' and 'Group email'). The right panel, titled 'IPv4', contains the following settings: Host Name (input field with 'x x x'), MAC Address (a0:ef:84:01:23:21), IPv4 Address Assignment Mode (Automatic dropdown), IPv4 Address (10.10.148.147), Subnet Mask (255.255.255.0), Gateway Address (10.10.148.254), and Domain Name (empty input field). At the bottom right of the IPv4 panel are 'Apply' and 'Cancel' buttons.

4.3.2. Set or Change Web Server Login Password

Use the embedded Web server to set a network password or change the existing password.



Note: The default username is "admin", and the initial password is "000000".

1. To open the embedded Web server, please log in first.
2. Click "User Management" tab.
3. Type the new password in the Password box and Confirm Password box.
4. At the bottom of the window, click Apply button to save the settings.

4.3.3. Restore to Factory Settings

If you want to reset all parameter settings of the printer, you can restore to the factory settings by long pressing "Cancel/Continue" button when the printer is powered off to power on it and holding for 10 seconds until the printer enters Ready status to finish the resetting work.

5. Wireless network setup (applicable to Wi-Fi models)

Depending on model, the printer with Wi-Fi printing function supports the two types of wireless network connection of both infrastructure connection mode and Soft-AP, while there is usually only one connection between computer and printer at a time. If you have problems during wireless network setup, please refer to [Chapter 5.3](#) Wireless Network Setup Frequently Asked Questions.

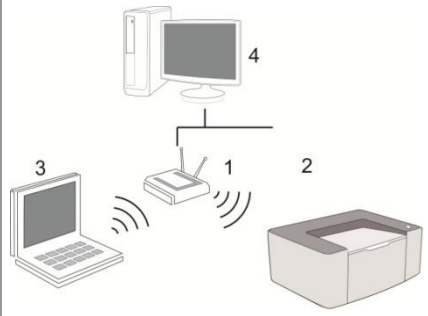
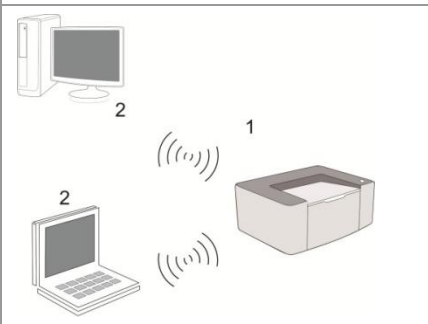
	<p>Basic structure mode: connecting to a wireless device via router</p> <ol style="list-style-type: none">1. Access point (wireless router)2. Wireless network printer3. Computer connecting to access point via wireless network4. Computer connecting to access point via network cable
	<p>Soft-AP</p> <p>The wireless computer is directly connected to the wireless device.</p>

5.1. Basic structure mode

You can connect a computer to your printer via access point (wireless router) as the medium. Access point (wireless router) connection is divided into wireless network setup and Wi-Fi Protected Setup (WPS).

Important: Before wireless network installation, you must learn about the service set identifier (SSID) and password of your access point in order to use them during wireless network setup. If they cannot be determined, please consult your network administrator or access point (wireless router) manufacturer.

5.1.1. Wireless network setup tools

If your computer has been installed with a driver and had been connected to wireless network, but the wireless network was changed, you can set it again with wireless network setup tools.

5.1.1.1. Preliminary preparations

1. Access point (wireless router).
2. A computer that has been connected to network.
3. A printer that has wireless network function.

5.1.1.2. Setup methods of wireless network setup tools

1. Take the wireless network setup tool in computer.

1) **Windows system:** Click the "Start menu" – "All programs" – "G&G" – Product name – "Wireless network setup tool".

2) **macOS system:** click "Go" - "Applications" - "G&G" - "Utilities" - "Wireless Network Configuration Tool" on the computer Finder menu bar.

2. Use USB cable to connect and configure. Select "Yes, I have a USB cable that can be used for installation" in the following interface. Click "Next".

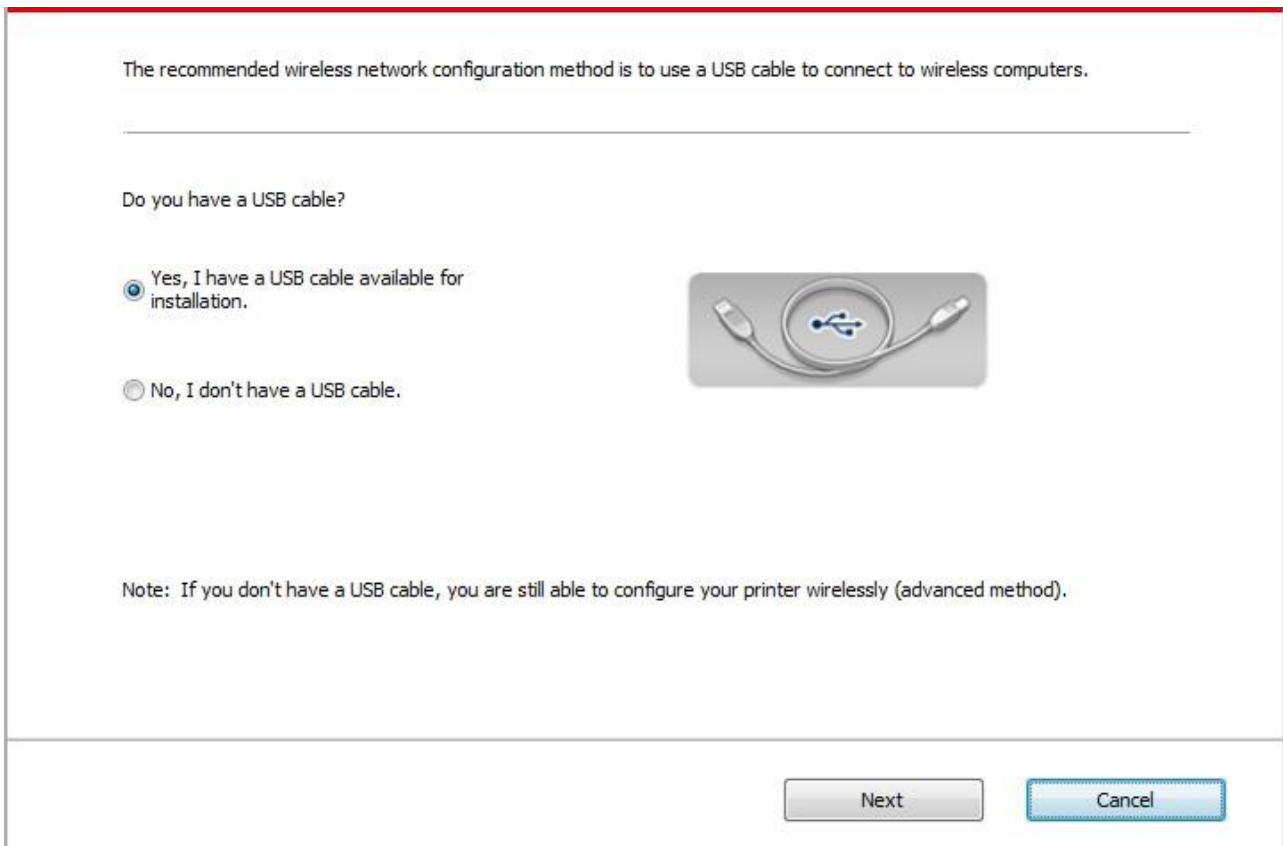

2.1 The computer has been connected to wireless network.

1) The currently wireless network currently connected to computer is selected as wireless network configuration tool by default. Complete configuration according to interface prompt.

Your computer's wireless network settings or wireless access point has been detected.

The wireless network name (wireless access point/router name) was detected:

SSID: Test-AP2

Are you going to use these settings to connect to the wireless network?

Yes

No

 **Note:** • The SSID you selected should be consistent with the SSID of access point (wireless router) connected to your computer.

2) Please tick “No” to configure other wireless network needed to connect to. Complete configuration according to interface prompt.

Please select the corresponding network name (SSID) from the following list, or manually enter the SSID and password if necessary, and then click "Next" to configure.

Network Name	Encryption method	Signal Strength
Test-AP2	WPA/WPA2	100%
Test-AP3	WPA/WPA2	100%

Network Name (SSID):

Encryption method:

Password:
 Show password



Note: • Encryption method:

1) None: There is no encryption method used.

2) WPA/WPA2: it is the pre-shared key (PSK) of Wi-Fi protected access which connects wireless device and access point via TKIP or AES encryption (WPS-Personal). The working length of WPA/WPA2 is within the PSK of 8-63 characters.

• The display password is not ticked by default; if it is ticked, all passwords input can be seen in clear text.

• Some models can automatically match the encryption method, no manual selection is required.

2.2 The computer is not connected to wireless network Input the SSID (case sensitive) and password of access point (wireless router) in the interface below. Complete configuration according to interface prompt.

1. Please click on "Print wireless network information page" to get the network name and encryption method. Please skip this step if you already know the network name and encryption method.

Printing wireless network information page

2. Please enter wireless network user name and password.

Network Name (SSID):

Encryption method:

None

Back Next Cancel



Note: • If you do not know the SSID of access point (wireless router), please click "Print Wireless Network Information Page" to view the SSID of the needed access point (wireless router).

• If the printer cannot be used normally after wireless network setup is finished, please install the drive again.

3. Use WPS connection .

Select "No, I don't have a USB cable" in the interface below and then click "Next".

The recommended wireless network configuration method is to use a USB cable to connect to wireless computers.

Do you have a USB cable?

Yes, I have a USB cable available for installation.

No, I don't have a USB cable.



Note: If you don't have a USB cable, you are still able to configure your printer wirelessly (advanced method).

1) Use WPS method to perform steps below to start wireless network on printer. (Please refer to [Chapter 5.1.2](#) for detailed WPS configuration)

Use WPS method to perform steps below to start wireless network on printer.

1. Hold Wi-Fi button on printer for 2s.
2. Set the access point to WPS mode.
For details, see the guide provided with the access point.
3. After all of the above are done, please click "Next".

If you encounter any problems in the configuration process, place the printer closer to the location of the Wireless Access Point for the time being.

2) Judge if the printer is successfully connected according to the status of Wi-Fi indicator on printer. If configuration failed, please click "Previous" to configure again; if configuration succeeded, please click "Done" to complete configuration.

Check the Wi-Fi light on the the printer. What is the status shown by the Wi-Fi light?

 If the light is off, configuration is unsuccessful. Please click "Back" to reconfigure.

 If the light is on, configuration is successful.

Note: If the light is blinking, the printer is being configured. Please wait.



Note: • If the printer cannot be used normally after wireless network setup is finished, please install the drive again.

5.1.2. Wi-Fi Protected Setup (WPS) setup

If the access point (wireless router) supports Wi-Fi Protected Setup (WPS), the Wi-Fi key on the control panel of printer and WPS key on access point (wireless router) can be pressed in order to connect the printer to wireless network.

5.1.2.1. Preliminary preparations

1. The access point (wireless router) supports Wi-Fi Protected Setup (WPS).
2. A printer that has wireless network function.

5.1.2.2. Wi-Fi Protected Setup (WPS) method

1. Turn on the power of printer and access point (wireless router).
2. Make sure the printer is in ready state.



Note: • If the printer is in sleep mode, it can be woken up by pressing any key on the control panel of printer.

3. Press the “Wi-Fi key” on the control panel of printer for more than 2s until the blue Wi-Fi indicator of printer blinks, and then release pressing.
4. Press the WPS key on access point (wireless router) within 2min and then release it.
5. When the access point (wireless router) and printer start to connect, the blue Wi-Fi indicator of printer starts to blink. The blue Wi-Fi indicator of printer will be normally on after successful connection.

If the connection is not established after more than 2min, the printer will return to its ready state, the Wi-Fi indicator will be off and Wi-Fi Protected Setup (WPS) connection will fail. If it is needed to connect again, please repeat steps 3-4 above.



Note: • After successful Wi-Fi Protected Setup (WPS) connection, please install a driver if you want to print via wireless network.

5.1.3. How to disable the Wi-Fi network connected

Please complete the wireless network connection in infrastructure mode according to above steps. If connected, the Wi-Fi indicator on the status control panel will be always on; now if you want to disconnect it, please press and hold this key for more than 2 seconds (the Wi-Fi indicator will be off).

5.2. Wi-Fi hotspot mode

You can establish a connection between a wireless network-enabled computer and a wireless network-enabled printer without using an access point (wireless route).

5.2.1. Preliminary preparations

1. Printer with Wi-Fi hotspot function.
2. Computer with wireless network function.

5.2.2. Wi-Fi Hot Connection

Before connecting the printer hotspot, enable the Wi-Fi hotspot function of the printer by tapping the "Wi-Fi" button on the printer panel.

 **Note:** Tap the "Wi-Fi" button on the printer panel, and the printer will automatically print the "Mobile device Wi-Fi connection guide page" for Wi-Fi connection of a mobile device.

5.2.3. Wi-Fi Hotspot Configuration

When the wireless hotspot of printer is active, the user can connect to it directly by searching. The wireless hotspot is enabled by default, and the default password is "12345678". The printer-specific SSID and password can be obtained from Wi-Fi Configuration Information Page, which can be printed out by selecting Print Wi-Fi Configuration. After establishing the connection, the configuration can be completed according to the Web configuration method.

5.3. Wireless network setup FAQs

1. The printer is not found.

- If the power of computer, access point (wireless router) or printer is turned on.
- If the computer is connected to printer with USB cable.
- If the printer supports wireless network connection.

2. SSID cannot be found when network is connected

- Inspect if the power switch of access point (wireless router) is turned on.
- The printer cannot find the SSID of the access point (wireless router) you need to connect, please check the SSID of access point and try to connect again.
- Every time when the setup of access point (wireless router) is changed, you must set up the wireless network of printer again.

3. Connection failure

- Please inspect if the safe mode and password of access point (wireless router) and printer is correct.
- Inspect the wireless receiving around printer. Signal receiving may be affected if the router is away from the printer or there is an obstacle between them.
- Turn the power of access point (wireless router) and printer off and then restart them and set up.

4. The following aspects should be inspected if the printer has problems while they are used in network:

- Inspect if the firewall software blocks communication. If the computer and printer are connected in the same network but they cannot be searched, the communication might be blocked by firewall software. Please refer to the user guide of firewall software to turn firewall off and then try to search the printer again.

-
- Inspect if the IP address assignment of printer is correct. You can inspect IP address by printing the network setup information page of printer out.
 - Please refer to the following steps to check if printer and computer are in the same network:
 - 1) Select "Command prompt" as shown below.
 - a. Windows 8/10 system: Select "Search" button in the Start Menu and input "Command prompt" in search bar, then press the "Enter" button in the keyboard.
 - b. Windows 7/Vista/XP system: click "Start" menu-"All procedures"-"Attachment"-"Command prompt".
 - 2) Input ping and your printer IP address in popup window, and press "Enter" button.
For example: ping XXX.XXX.XXX.XXX("XXX.XXX.XXX.XXX" is printer IP address)
 - 3) If RTT is indicated in the window, that is to say your printer and computer are in the same network. If RTT is not indicated in the window, please refer to [Chapter 5](#) to re-configure the printer wireless network.



Note: • Please refer to the user guide or consult the manufacturer for information related to access point (wireless router).

6. Mobile Print (for models with Wi-Fi function only)

6.1. "G&G SmartPro" APP

G&G SmartPro APP is a free application with mobile printing, scanning and faxing functions, allowing you to print or fax photos, files, pages and scan photos or files directly from mobile terminal. Your printer may not support all of above mentioned functions, so please select relevant function of G&G SmartPro APP for use according to your printer type. Please be sure the application has been installed and connected to wireless network properly before use.

6.1.1. Operating systems supported

"G&G SmartPro App" is suitable for Android 5.1-10.0 and iOS 9.0-14.0 system versions.

6.1.2. How to download G&G SmartPro APP

How to download it for Android mobile device:

1. You can download it from its official website https://www.ggimage.com/ggprinter_app
2. You can use Google Play Store > Apps > to search G&G SmartPro > Download and install.

How to download it for iOS mobile device:

Click the App Store icon > Search interface > input "G&G" or "G&G SmartPro" in the search bar > Download and install on the interface of iOS device to download.

6.1.3. How to use this "G&G SmartPro" APP

6.1.3.1. For Android Devices

6.1.3.1.1. Preliminary preparations

1. A printer that has wireless network function.
2. Android mobile device.

6.1.3.1.2. Operation steps

1. Turn on printer power.
2. For an Android mobile device, tap the "G&G" icon on the main screen to enter the first interface of "G&G".
3. Select the connection method according to your habit to connect the printer.
4. Select the function you want and then do relevant settings to meet your functional demands.



- Note:**
- If failure of operation, please check if your Android mobile device has access to the wireless network into which your printer is connected.
 - If the Android device cannot detect any printer, please inspect if power of the printer is turned on and if the printer is turned on.
 - For more details, please refer to the mobile print user guide attached.
-

6.1.3.2. For iOS Devices

6.1.3.2.1. Preliminary preparations

1. A printer that has wireless network function.
2. iOS mobile device.

6.1.3.2.2. Operation steps

1. Turn on printer power.
2. For an iOS mobile device, tap the “G&G” icon on the main screen to enter the first interface of “G&G”.
3. Select the connection method according to your habit to connect the printer.
4. Select the function you need and set it up to meet your function needs.



- Note:**
- If printing fails, please inspect if the iOS device is connected to the wireless network where the printer is connected to.
 - If the iOS mobile device did not detect any printer, check whether the printer is powered on and the printer is turned on.
 - For more details, please refer to the mobile print user guide attached.
-

6.2. Mopria mobile print

Mopria mobile print is currently not supported.







6.3. AirPrint mobile print

AirPrint mobile print is currently not supported.

7. Print

7.1. Print Function

The print function can be achieved through the settings of various properties in the Printing Preferences, and some of the functions are as follows.

Functions	Diagram
Manual Duplex	
Collate	
Reverse Print	
N-in-1	
Poster Print (for Windows system only)	
Zoom Print	
Custom Size	

 **Note:** • You can select the 2 x 2 Poster Print in N-in-1 to enable the poster printing function.
• You can open the Printing Preferences and click Help button to view the specific function explanation. For information about how to open the help document, see [Section 7.2](#).

7.2. Opening Help Document

You can open the Printing Preferences and click Help button (for Windows system only). The help document contains the user guide where you can find the information on print settings.

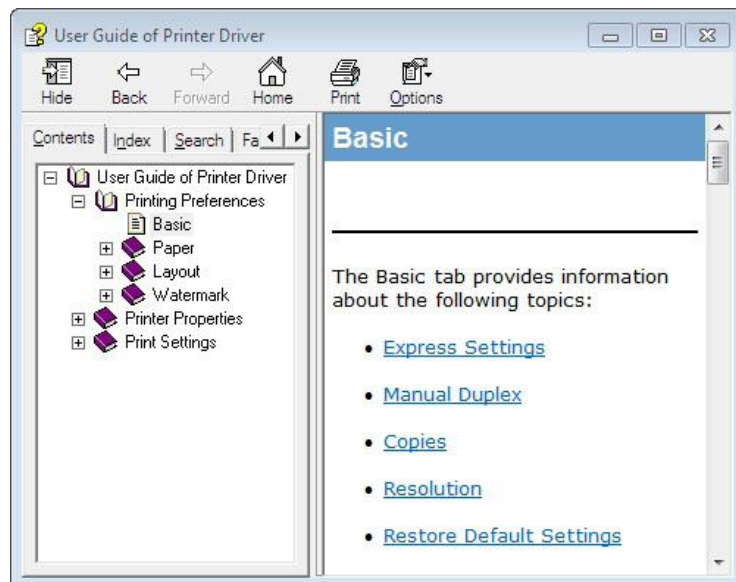
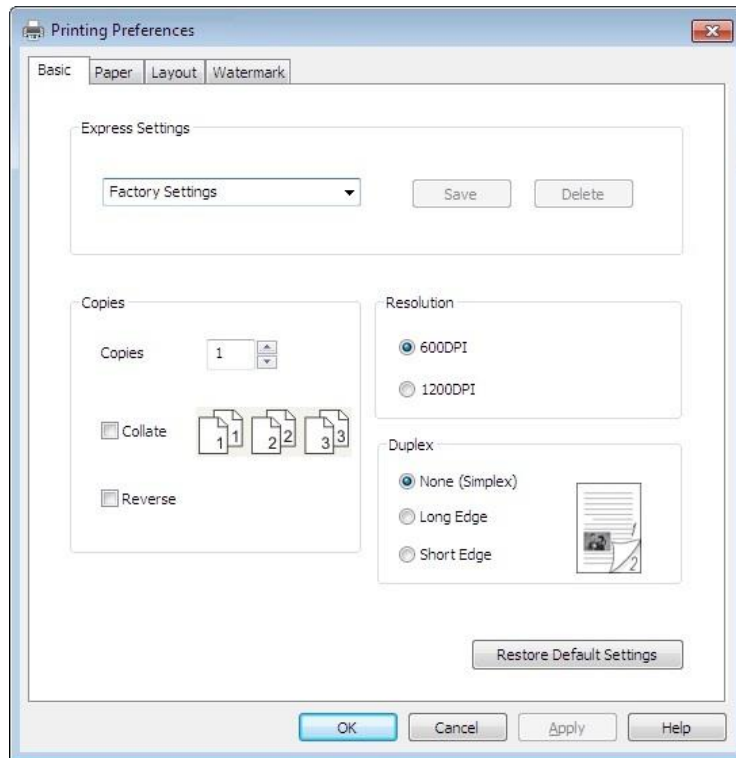

7.3. Manual Duplex

1. The printer driver supports manual duplex.

 **Note:** If the paper is thin, it may wrinkle.

- If the paper is curled, make it flat and put it back into the manual feeder tray or automatic feeder tray.
 - If the manual duplex function causes a paper jam, see [Section 10.1](#) for handling it.
-

2. Ensure that certain amount of paper is loaded into the automatic feeder tray before printing.

 **Note:** For loading paper, see [Section 2.2](#).

- For the type of media that can be printed with the automatic feeder tray, see [Chapter 2.1](#). It is recommended to use the standard paper.
 - Some paper media are not suitable for the duplex printing. Trying the duplex printing with it may damage the printer. When Paper Type is Thick or Transparency, please do not try Duplex Printing. If 2 x 2 Poster Print is checked in the Printing Preferences dialog box, Manual Duplex will not be supported.
 - Paper will get jammed or cannot be fed in when the automatic feeder tray is loaded with more than 150 sheets.
-

3. Printing steps are as follows (for Windows system only) :

a) Open the document to be printed from the application (such as Notepad), and select Print from the File menu

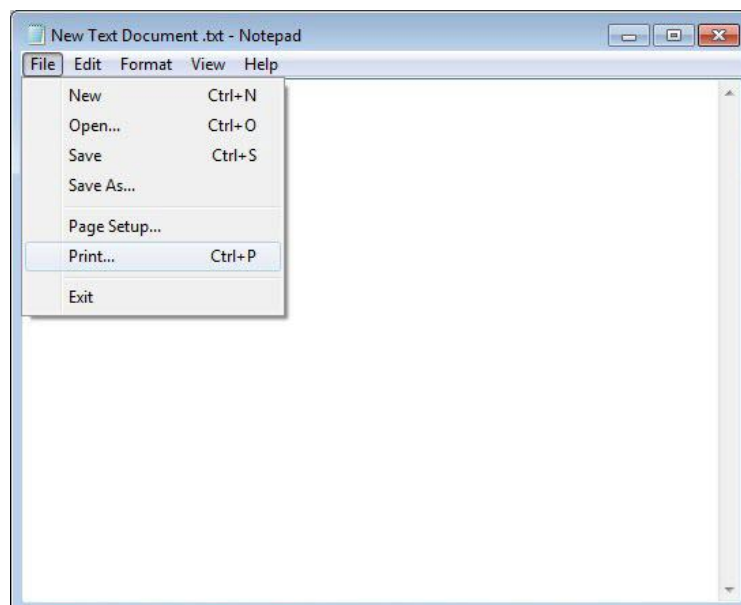

b) Select G&G printer

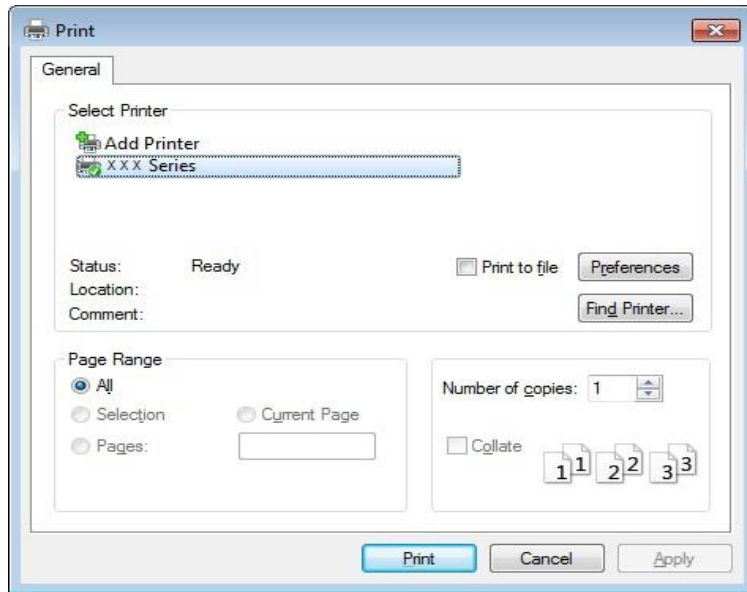

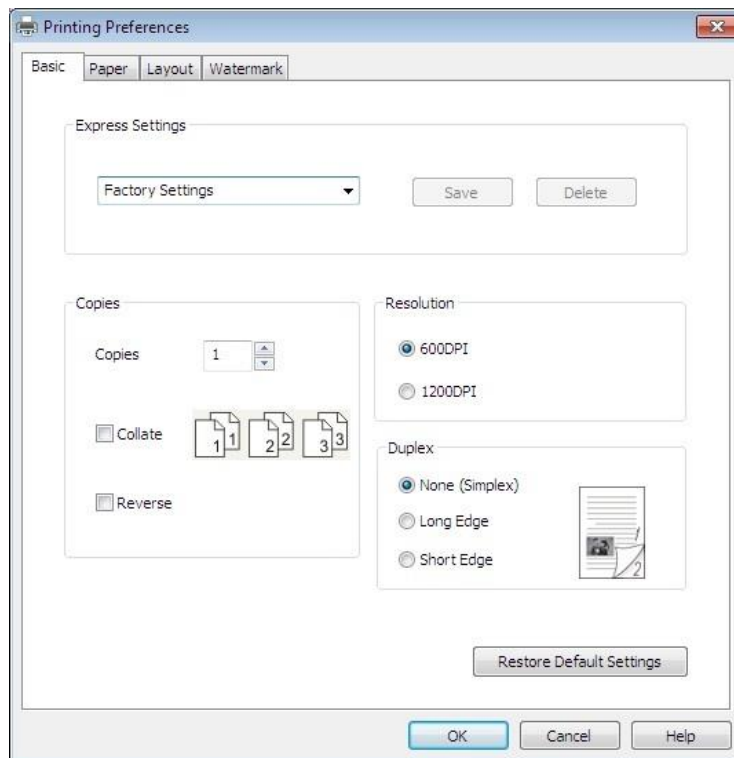

Click Preferences to set up for printing.

c) Check Manual Duplex in the Basic tab and click OK after completing the settings

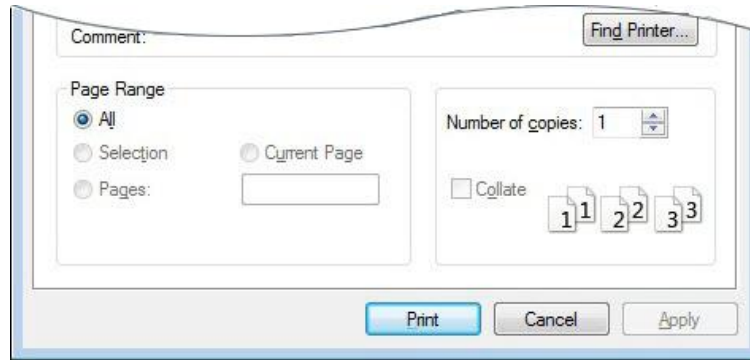

d) Click Print.



 **Note:** It is recommended to raise the output tray to prevent the paper from sliding out of it. If you choose not to raise the output tray, we recommend that you immediately remove the printed paper output from the printer.

e) Send the print job after choosing Manual Duplex, then the following prompt window will appear, telling you the next specific operations. Interfaces are different depending on the models.



f) After turning over the paper according to the prompt, press Continue button of the printer to go on printing the other side.

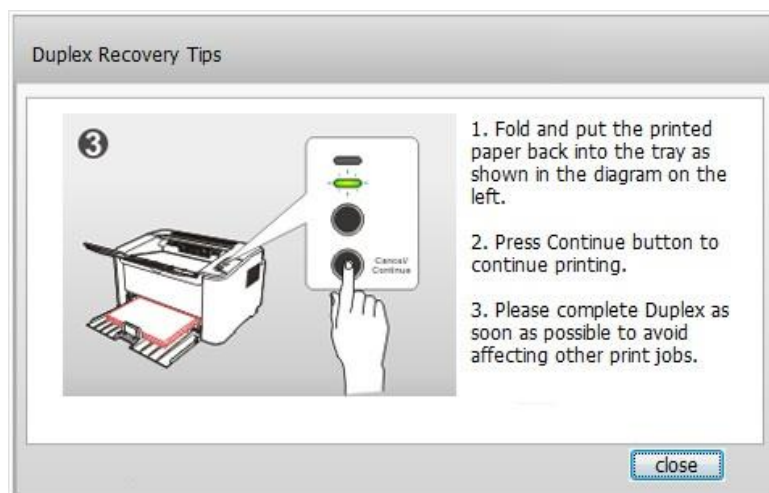

g) You can click Close button to close this prompt window, and it will not appear until the next Manual Duplex job comes in.

7.4. Cancel Print Job

Press and hold the Cancel/Continue button on the control panel to cancel the job you want to cancel during the printing process.

8. Control Panel

8.1. Control Panel Overview for P2022 Series

The printer control panel layout includes 2 buttons and 2 multi-colored LED indicators as shown below. The diagram on the left shows the control panel of the printer with USB+Wi-Fi interface, while the one on the right displays the control panel of the printer with USB interface only:

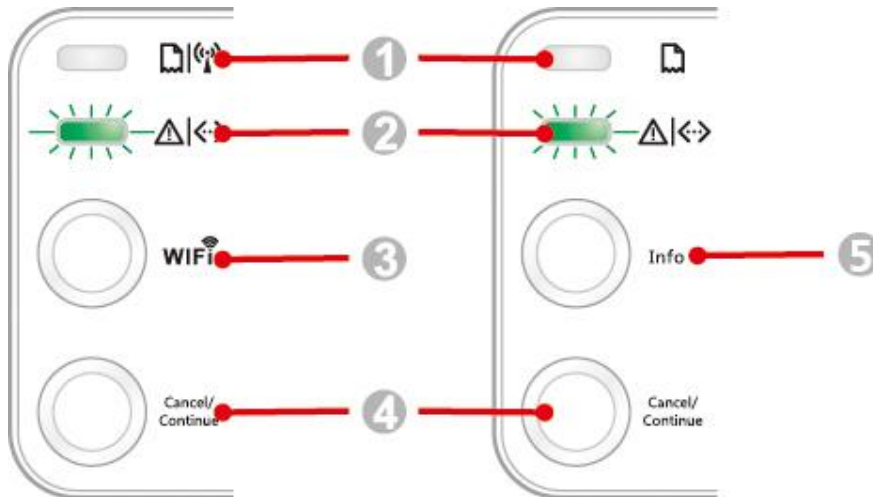

Serial No.	Name
1	Multi-colored LED1 indicator
2	Multi-colored LED2 indicator
3	Wi-Fi search button
4	Cancel/Continue button
5	Information button

8.1.1. Functions of Buttons on the Control Panel

8.1.1.1. Operation Function of Wi-Fi Search Button

If there is no Wi-Fi connection, short-press this button to launch Wi-Fi connection and search Wi-Fi Hotspot AP; stop searching if it fails to find any Access Point (AP) within 2 minutes.

If there is no Wi-Fi connection, press and hold this button to launch WPS connection, and meanwhile press the WPS button on the wireless router within 2 minutes; stop WPS connection if Wi-Fi connection cannot be established within 2 minutes.

If there is Wi-Fi connection while no Wi-Fi print job, press and hold this button to disconnect Wi-Fi connection.

If there is Wi-Fi connection and Wi-Fi print job, wait until the job is completed and then press and hold this button to disconnect the Wi-Fi connection.

During Wi-Fi connection or WPS searching, you can long press it to cancel the connection or searching.

8.1.1.2. Operation Function of Cancel/Continue Button

If the printer is in sleep mode, press or press and hold this button can wake it up.

Press and hold this button during printing can cancel the current print job.

When the printer is in ready mode, press and hold this button can print the test page.







8.1.1.3. Operation Function of Information Button

When the printer is in ready mode, press and hold this button can print the test page.

8.1.2. Function of LED Indicators on the Control Panel









8.1.2.1. LED1 Status Indication

The meanings of the status indication of LED1 are as follows:

Serial No.	Paper/Wi-Fi Multi-colored LED1 Status Indication	Status Description (For printers with USB+W-iFi interface)	Status Description (For printers with USB interface)
1		No Wi-Fi connection, no paper error, sleep mode LED1 off	No Wi-Fi connection, no paper error, sleep mode LED1 off
2		Searching W-iFi, no indication of paper error LED1 with green light flashing slowly	N/A
3		Connecting Wi-Fi..., no indication of paper error LED1 with green light flashing quickly	N/A
4		Successful Wi-Fi connection, no paper error LED1 with green light staying on	N/A
5		Paper Jam Error LED1 with red light staying on	Paper Jam Error LED1 with red light staying on
6		Paper shortage in printing, or failed in feeding LED1 with red light flashing quickly	Paper shortage in printing, or failed in feeding LED1 with red light flashing quickly



8.1.2.2. LED2 Status Indication

The meanings of the status indication of LED2 are as follows:

Serial No.	Data/Cartridge Multi-colored LED2 Status Indication	Status Description (For printers with USB+Wi-Fi interface and the ones with USB interface only)
1		Starting and warming up the printer, waking up and warming up the printer, and warming up the printer by opening and closing its cover. LED2 with green light flashing slowly
2		The printer is ready LED2 with green light staying on
3		Sleep LED2 with green light on and flashing slowly
4		Printing Multi-colored LED2 with green light flashing quickly
5		Alarming for toner low LED2 with orange light on and flashing quickly
6		Cartridge error (not installed, mismatch, expired) LED2 with orange light staying on
7		Serious printer error (heating roller abnormalities, laser motor abnormalities, communication error, opened cover, etc.) LED2 with red light staying on
8		A job is cancelled via the panel LED2 with light flashing quickly

8.1.2.3. Indication of LED1 and LED2 Combination Status

You can refer to the indicator combination list for information on the working status of the printer. Some of the LED1 and LED2 combined indications are as follows:

Serial No.	Status		Status Description
	Paper/Wi-Fi (Multi-colored LED1)	Data/Cartridge (Multi-colored LED2)	
1			Paper jam, the printer is ready LED1 with red light staying on, LED2 off
2			Paper jam during printing LED1 with red light staying on, multi-colored LED2 off
3			Paper jam, alarming for toner low LED1 with red light staying on, LED2 off
4			Paper jam, cartridge error (not installed, mismatch, expired) LED1 with red light staying on, LED2 off
5			Paper jam, serious printer error (heating roller abnormalities, laser motor abnormalities, communication error, opened cover, etc.) LED1 off, LED2 with red light staying on
6			Paper jam, a job is cancelled via the panel LED1 off, LED2 with green light flashing quickly
7			Paper shortage in printing, or failed in feeding, only showing paper errors LED1 with red light flashing quickly, LED2 off
8			Paper shortage in printing, or failed in feeding, alarming for toner low LED1 with red light flashing quickly, LED2 off
9			Paper shortage in printing, or failed in feeding, cartridge error (not installed, mismatch, expired) LED1 off, LED2 with orange light staying on
10			Paper shortage in printing, or failed in feeding, and meanwhile, serious printer error (heat roller abnormalities, laser motor abnormalities, communication error, opened cover, etc.) LED1 off, LED2 with red light staying on
11			A job is being cancelled via the panel because of paper shortage in printing or failure in feeding LED1 with green light off, LED2 with green light flashing quickly

9. Routine Maintenance

9.1. Cleaning the Printer

 **Note:** Please use mild detergents.

Please clean the printer in accordance with the following steps:

1. Turn off the main power switch and unplug the power cord and USB cable.

P2022 Series

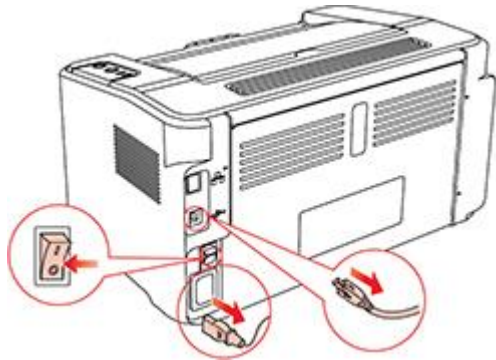

2. Use a soft cloth to wipe the outside of the printer clean.

P2022 Series

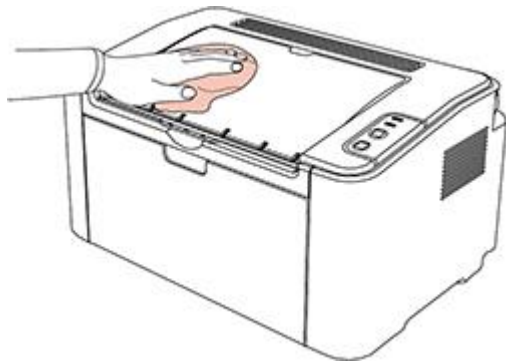

3. Open the upper cover and take out the laser toner cartridge.

P2022 Series

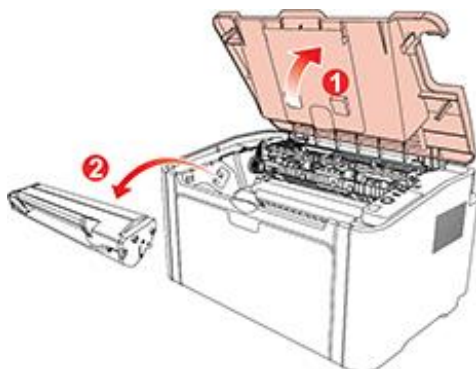

 **Note:**• When removing the laser toner cartridge, put the cartridge in a protective bag or wrap it with thick paper to avoid direct light damaging the photosensitive drum.

4. Clean the inside of the printer by using a dry and lint-free cloth to gently wipe the shaded area as shown in the figure below.

P2022 Series

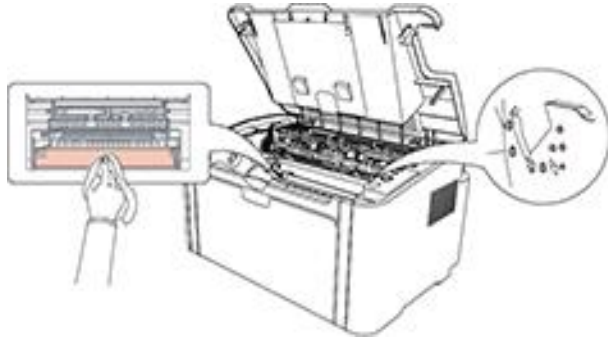

9.2. Maintenance of Laser Toner Cartridge

9.2.1. Use and Maintenance of Laser Toner Cartridge

For better print quality, please use the original G&G laser toner cartridge.

 **Note:**when using the laser toner cartridge, please pay attention to the following:

- Unless used immediately, otherwise, do not remove the laser toner cartridge from the package.
Do not attempt to refill the laser toner cartridge without authorization. Otherwise, the resulting damage is not included in the printer warranty.
 - Please store the laser toner cartridge under a cool and dry environment.
 - Toner inside the laser toner cartridge is combustible. Please do not put the laser toner cartridge near any source of ignition, so as to avoid causing a fire.
 - When removing or disassembling the laser toner cartridge, please pay attention to the toner leakage problem. In case of the toner leakage resulting in that the toner contacts with your skin or splashes into your eyes and mouth, please immediately wash with clear water, and consult a doctor immediately if you feel unwell.
 - When placing the laser toner cartridge, please keep it away from the area reachable by children.
-

9.2.2. Service Life of Laser Toner Cartridge

Service life of the laser toner cartridge depends on the amount of toner that print jobs require. When the printer LED indicator shows the status in the following figure, it indicates that the laser toner cartridge life has expired and needs to be replaced.



9.2.3. Replace Laser Toner Cartridge

 **Note:** before replacing the laser toner cartridge, please pay attention to the following:

- The laser toner cartridge surface may contain toner. Please remove it carefully to avoid spilling.
 - Put the removed laser toner cartridge on a piece of paper to avoid the toner from accidentally spilling.
 - After removing the protective cover, please immediately install the laser toner cartridge into the printer, so as to avoid photosensitive drum damage caused by exposing to too much direct sunlight or indoor light.
 - While installing the laser toner cartridge, do not touch the surface of the photosensitive drum so as not to scratch it.
-

Replacement steps are as follows:

1. Open the upper cover, and remove the empty laser toner cartridge along the guides.

P2022 Series

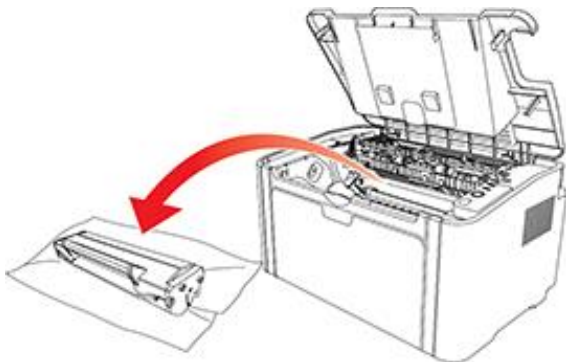

2. Open the package of a new laser toner cartridge, hold the handle of the cartridge and gently shake around 5-6 times, so as to make the toner evenly distributed inside the cartridge.

P2022 Series

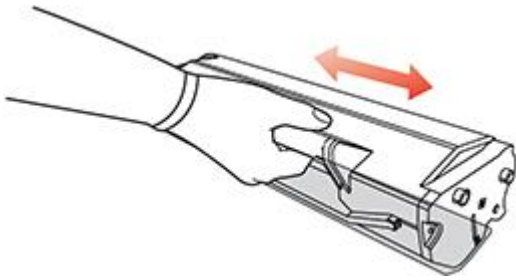

3. Remove the protective cover, and put the laser toner cartridge into the printer along the guides

P2022 Series

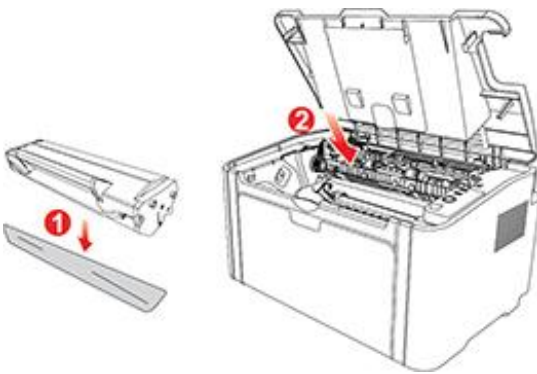

 **Note:** • Check whether there is any seal on it before installing the laser toner cartridge into the printer; if there is any, please tear off the seal and then install the cartridge.

P2022 Series

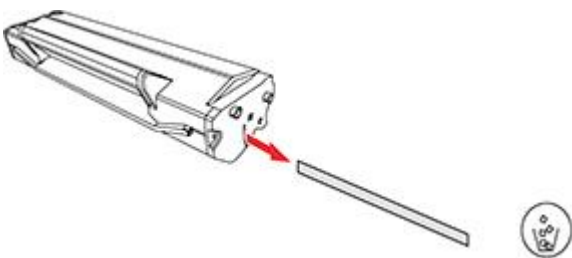

4. Close the upper cover tightly

P2022 Series

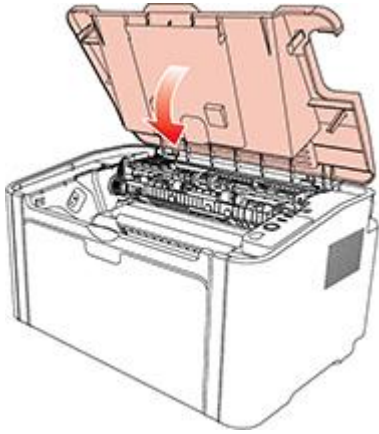

10. Troubleshooting

Please read this section carefully. It can help you solve common trouble in the printing process. If the problems appeared cannot be solved, please contact G&G Aftersales Service Center.

Prior to handling common trouble, first check that:

- The power cord is connected correctly and the printer is powered on.
- All of the protective parts are removed.
- The laser toner cartridge is correctly installed.
- The output bin is fully closed.
- The paper is correctly loaded into the tray.
- The interface cable is correctly connected between the printer and the computer.
- The correct printer driver is selected and installed properly.
- The computer port is properly configured and is connected to the proper printer port.

10.1. Clearing Jammed Paper

-  **Note:** Remove the jammed paper in accordance with the following steps, close the upper cover and tidy the paper in the tray, then the printer will automatically resume printing. If the printer cannot automatically start printing, please press the button on the control panel.
- If the printer still does not start printing, please check whether all the jammed paper inside the printer are cleared.
 - If you cannot remove the jammed paper yourself, please contact your local G&G authorized repair center or send the printer to the nearest G&G authorized service center for repair.
-

10.1.1. Paper Jam in the Feed Port

If the output bin is open, please close it first.

Gently pull the jammed paper straight out.

P2022 Series



If the paper does not move while being pulled, or there is no paper in this area, please check the inside of the printer.

10.1.2. Paper Jam inside the Printer

1. Open the upper cover.

P2022 Series

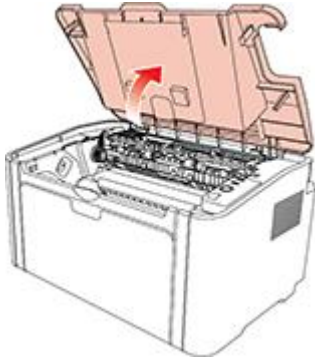

2. Open the upper fuser guide to decrease the pressure of compression spring.

P2022 Series

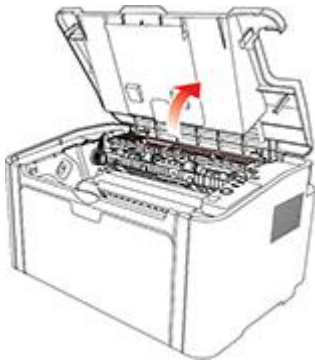

3. Pull the jammed paper out of the fuser unit.

P2022 Series

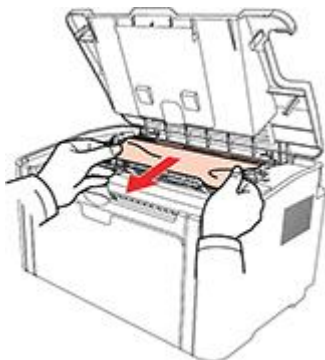

If no jammed paper is found, please go to the next step.

4. Remove the laser toner cartridge along the guides

P2022 Series

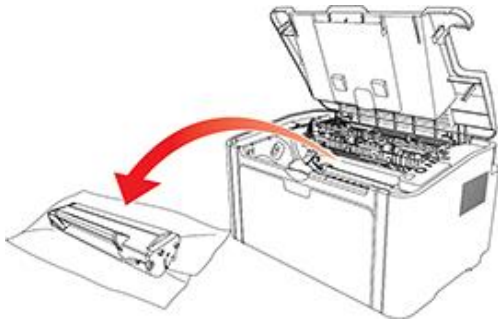

5. Slowly pull the jammed paper out along the paper output orientation.

P2022 Series



6. After removing the jammed paper, insert the laser toner cartridge into the printer along the guides until you hear a click assuring you that the cartridge is fully inserted.

P2022 Series

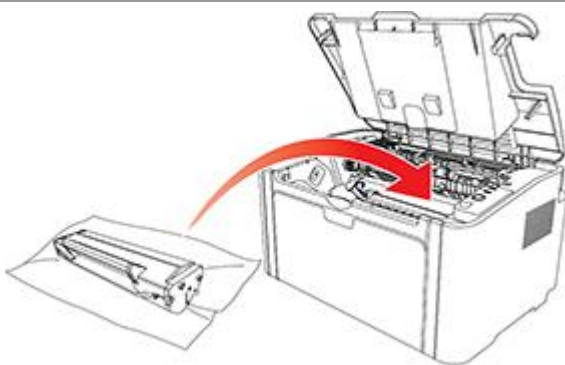

7. Put the paper in the tray neatly, and do not carry out the next print until the indicator resumes print-ready status.

P2022 Series

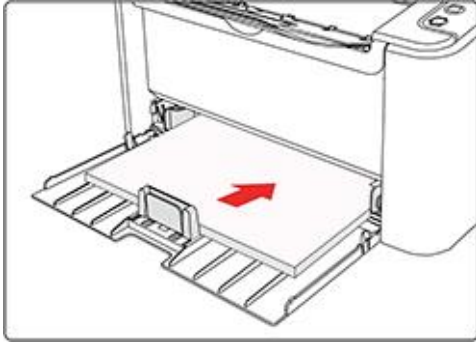

10.2. Common Troubleshooting

10.2.1. Common Trouble



Trouble	Cause	Solution
Printer Problems		
The printer does not work	The cable between the computer and the printer is not connected properly.	Disconnect and then reconnect the printer cable.
	Error in specifying the print port.	Check the printer settings to ensure that the print job is sent to the correct port. If the computer has more than one port, make sure that the printer is connected to the correct port.
	The printer is offline, and Use Printer Offline is checked.	Make sure that the printer is in the normal online status.
	The printer does not recover from an internal error, such as a paper jam, paper empty, etc.	
Problems in toner cartridge		
The toner cartridge chip can not be recognized	The toner cartridge chip is dirty.	Please clean the surface of the toner cartridge chip.
	The contact spring or copper pillar of the toner cartridge chip is dirty.	Please clean the contact spring or the copper pillar.
Problems in Handling Paper		
Paper feed failure	The print media is loaded incorrectly.	Please correctly load the print media. If you use special print media for printing, please print with the manual feeder tray.
	The print media is beyond the usage specification range.	Please use the print media within the specification range.
	The feed roller is dirty.	Clean the feed roller.

Paper Jam	<p>There is too much paper in the tray.</p> <p>The print media is beyond the usage specification range.</p> <p>There is foreign matter in the feed channel.</p> <p>The feed roller is dirty.</p> <p>Internal parts failure.</p>	<p>Remove excess paper from the tray. If you print on special print media, please use the manual feeder tray.</p> <p>Make sure to use the paper that meets specifications. If you print on special print media, please use the manual feeder tray.</p> <p>Clean the feed channel.</p> <p>Clean the feed roller.</p>
Print with multipage fed in	<p>Excessive static electricity on the print media.</p> <p>The print media is damp and sticks together.</p> <p>Internal parts failure.</p>	<p>Separate the print media to eliminate some static electricity. It is suggested that you use the recommended print media.</p> <p>Separate the print media or use better and dry print media.</p>
The vapor comes out around the paper discharge area	<p>The heat generated during the toner fusing causes the paper to vapor (This happens even more often when you use dampened paper under low ambient temperature)</p>	<p>Vapor is not an abnormality in this case, but still you can use newly unpacked paper to avoid generation of vapor. Also, keep your paper from the damp.</p> <p>Power off the printer and unplug the power cord when there is a smell of burning. Then consult G&G support center. It may causes the fire or the electric shock if you continue to use the printer under this situation.</p>



Note: • If the problem persists, please contact the customer service center. See the Guarantees certificate for contact details.

10.2.2. Image Defects

Trouble	Cause	Solution
 <p>The printout is whitish or light</p>	<ul style="list-style-type: none"> • Toner is low. • The print media does not meet usage specification, such as the media is damp or too rough. • The resolution in the print program is set too low. • The laser toner cartridge is damaged. 	<ul style="list-style-type: none"> • Please properly use the print media within the specification range. • Setup the print resolution in the program.
 <p>Toner spots</p>	<ul style="list-style-type: none"> • The laser toner cartridge is dirty or leaks toner. • The laser toner cartridge is damaged. • The print media that does not meet usage specification, such as the media is damp or too rough. • The feed channel is dirty. 	<ul style="list-style-type: none"> • Please use the print media within the specification range. • Clean the feed channel.
 <p>White spots</p>	<ul style="list-style-type: none"> • The print media that does not meet usage specification, such as the media is damp or too rough. • The feed channel is dirty. • The internal part of the laser toner cartridge is damaged. • The reflective glass of the laser inside the printer is dirty. 	<ul style="list-style-type: none"> • Please use the print media within the specification range. • Clean the feed channel. • Clean the reflective glass of the laser.
 <p>Toner comes off</p>	<ul style="list-style-type: none"> • The print media that does not meet usage specification, such as the media is damp or too rough. • The inside of the printer is dirty. • The laser toner cartridge is damaged. • The internal part of the printer is damaged. 	<ul style="list-style-type: none"> • Please use the print media within the specification range. If you use special print media, please print with the manual feeder tray. • Clean the inside of the printer.
 <p>Black vertical stripes</p>	<ul style="list-style-type: none"> • The laser toner cartridge is dirty. • The internal part of the laser toner cartridge is damaged. • The reflective glass of the laser inside the printer is dirty. • The feed channel is dirty. 	<ul style="list-style-type: none"> • Clean the reflective glass of the laser at the back of the printer. • Clean the feed channel at the back of the printer.



Black background
(gray background)

- The print media that does not meet usage specification, such as the media is damp or too rough.
- The laser toner cartridge is dirty.
- The internal part of the laser toner cartridge is damaged.
- The feed channel is dirty.
- The transfer voltage inside the printer is abnormal.
- Please use the print media within the specification range.
- Clean the feed channel inside the printer.

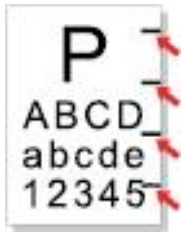

Cyclical traces
appear

- The laser toner cartridge is dirty.
- The internal part of the laser toner cartridge is damaged.
- The fuser component is damaged.
- Clean the laser toner cartridge or replace it with a new one.
- Please contact G&G Customer Service to repair and replace the fuser component.



Skewed pages

- The print media is loaded incorrectly.
- The feed channel of the printer is dirty.
- Ensure correct loading of the print media.
- Clean the feed channel inside the printer.

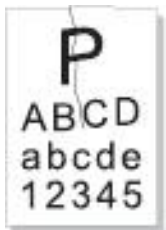

Wrinkled paper

- The print media is loaded incorrectly.
- The print media does not meet the usage specification.
- The feed channel inside the printer is dirty.
- The fuser component of the printer is damaged.
- Ensure correct loading of the print media.
- Please use the print media within the specification range for printing.
- Clean the feed channel inside the printer.



The back of the
printout is dirty

- The laser toner cartridge is dirty.
- The transfer roller inside the printer is dirty.
- The transfer voltage inside the printer is abnormal.
- Clean the laser toner cartridge or replace it with a new one.
- Clean the internal transfer components of the printer.



Whole page dark

- The laser toner cartridge is installed incorrectly.
- The internal part of the laser toner cartridge is damaged.
- Abnormal charge inside the printer; the laser toner cartridge is not charged.
- Ensure to install the cartridge correctly.



The toner does not adhere to the paper

- The print media that does not meet usage specification, such as the media is damp or too rough.
- The inside of the printer is dirty.
- The laser toner cartridge is damaged.
- The internal part of the printer is damaged.
- Please use the print media within the specification range. If you use special print media, please print with the manual feeder tray.
- Clean the inside of the printer.

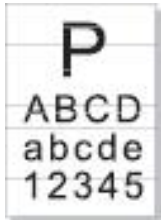

Horizontal stripes

- The laser toner cartridge is incorrectly installed.
- The laser toner cartridge might be damaged.
- The internal part of the printer is damaged.
- Ensure to install the cartridge correctly.



Note: • The faults above can be mitigated by cleaning or replacing the cartridge. If the problem persists, please contact the customer service center. See the Three Guarantees certificate for contact details.

11. Product Specification

11.1. P2022 Series Specification



Note: • Specification values are slightly different for different models of printers with different functions. These values are based on the initial data. For more information about the latest specification, please visit: www.ggimage.com.

11.1.1. Specification Overview

Processor	600MHz	
Memory	128MB	
Power Supply Model: P2022/P2022-OP221/OP221/ P2022W/P2022W-OP221W/OP221W	220V Model: AC 220-240V, 50/60Hz, 3.0A 100V Model: AC 100-127V, 50/60Hz, 6.0A 110V Model: AC 110-127V, 50/60Hz, 6.0A (Note: For the power supply and voltage that is suitable for this printer, please refer to the nameplate on the back of the printer. Please strictly use the power supply for the printer according to its specification.)	
Networked standby power consumption	Wi-Fi models < 3.0W Non Wi-Fi models < 2.0W	
Default automatic shutdown time	10 hours	
Communication interface	Hi-Speed USB 2.0; Wi-Fi 802.11b/g/n	
Operation environment	Best print quality	10-32 °C
	Humidity range for operation	20 to 80% RH
Product Size (W*D*H)	about 337mm*220mm*178mm	
Weight (excluding the laser toner cartridge)	about 4.0kg (excluding the attached laser toner cartridge)	
Control Panel	LED	

11.1.2. Printing Specification

Print Speed	A4	22ppm
	Letter	23ppm
First Page Print Time		7.8s
Print Language		GDI
Maximum print size		Legal (216mm*355.6mm)
Paper Input Capacity	Standard Tray	150 pieces (80g/m ²)
Paper Output Capacity	Print-side down	100 pieces (80g/m ²)
Print Media	Media Type	Plain paper, thin paper, thick paper, transparent film, card paper, label paper, envelope
	Media size	A4, A5, JIS B5, ISO B5, A6, Letter, Legal, Executive, Folio, Oficio, Statement, Japanese Postcard, Monarch Env, DL Env, C5 Env, C6 Env, No.10 Env, ZL, Big 16K, Big 32K, 16K, 32K, B6, Yougata4, Postcard, Younaga3, Nagagata3, Yougata2
	Media weight	60~163g/m ²



FAKULTÄT FÜR