



**REMOTE
CONTROLLED**



**3D FLIPS
& ROLLS**



**VARIABLE
SPEED
SETTINGS**



**ONE KEY
RETURN**

1. Important Safety Precautions

When using your Sonic the Hedgehog™ Sky Racer Drone basic safety precautions should always be followed, including the following:

1. Do not allow children or the infirm to operate your drone without adult supervision. For safety purposes, only allow experienced pilots aged 14 and up fly your drone.
2. To avoid choking hazards, keep all small parts and pieces away from children.
3. Your drone is not a toy. Make sure that it is properly assembled before use, and operated safely.
4. Keep your drone away from obstacles, crowds, power lines, trees, and bodies of water while it is in flight. Always fly your drone in a wide open spacious environment. Avoid flying your drone directly above people or animals. Maintain a 7 ft. (2m) distance from the aircraft when taking off and landing.
5. Only use your drone in a dry environment. Your drone is composed of sophisticated electronic components and parts. To avoid damage to your drone, please keep your drone away from water and moisture. Use a soft dry cloth to wipe the surface of your drone and keep it clean.
6. Beginner and novice level pilots should practice flying with experienced pilots until suitably experienced in flight.
7. To ensure safety, only use the included parts when using your drones.
8. Make sure to keep your ears and eyes protected when using your drone. When your drone's blades are spinning, make sure to keep people and objects at a distance from rotating parts.
9. Keep your drone away from excessive heat or flames, especially while charging the battery.
10. Please recycle or dispose of your drone properly based on the laws and rules of your municipality. Contact local recycling facilities and/or the manufacturer of your drone for further information.

2. IMPORTANT NOTE: FAA REGISTRATION

Owners of a drone that weighs more than 0.55 lbs. (250 g) and less than 55 lbs. (25 kg) must register their UAS online at the FAA website, <https://www.faa.gov/uas/registration>.

After receiving the certificate of registration, a unique FAA registration number will be provided and it must be marked on the Drone by any means, such as permanent marker, label, engraving or other means, as long as the number is readily accessible and maintained in a condition that is readable and legible upon close visual inspection.

Drone Safety Tips:

Register your drone.

Fly your drone at or below 400 feet.

Keep your drone within your line of sight.

Be aware of FAA Airspace Restrictions.

Respect privacy.

Never fly near other aircraft, especially near airports.

Never fly over groups of people, public events, or stadiums full of people.

Never fly near emergencies such as fires or hurricane recovery efforts.

Never fly under the influence of drugs or alcohol.

3. Introduction

Thank you for purchasing the Sonic the Hedgehog™ Sky Racer Drone, item DRC188. The included remote controlled aircraft is designed specifically for outdoor flying. In order to get the best possible results, please read this user's manual carefully before using. In addition, be sure to keep this manual in a safe place for future reference.

4. Package Contents

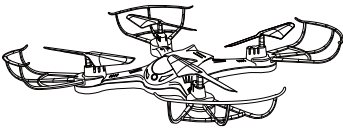

DRC188
Sky Racer Drone

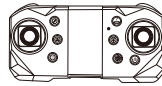

Joystick Controller



USB Charger

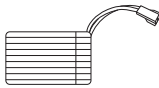

Rechargeable Lithium-ion Battery



Screws and
screw driver



Twist and Lock Legs

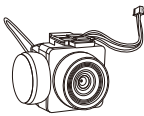

Camera

5. A Quick Look at Your Remote Control

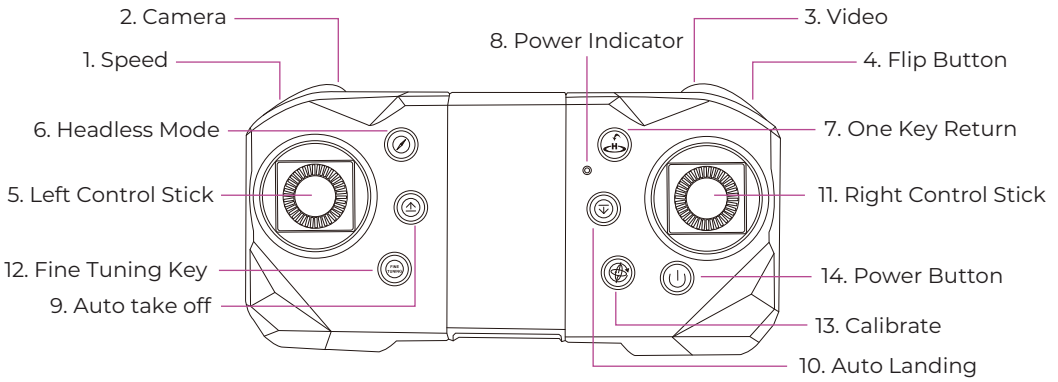

#	Name	Function / Effect
1	Speed	Adjust how fast the drone accelerates in response to movement of the control sticks.
2	Camera	Press for take photos.
3	Video	Press for take video, press again to quit video.
4	Flip Button	Press for 3D flips and rolls.
5	Left Control Stick	Moves your drone up and down, or turns your drone left and right.
6	Headless Mode	Press to enter or exit headless mode.
7	One Key Return	Press for one key return function.
8	Power Indicator	When blinking intermittently, the remote needs to be synchronized with the drone. Once the remote is synchronized with your drone, it will blink more rapidly.
9	Auto take off	Press for auto taking off one height and hove there.
10	Auto Landing	Press for auto landing until the motor stop.
11	Right Control Stick	Moves your drone forward & backward, or shifts your drone to the left and right.
12	Fine Tuning Key	Stabilizes the drone while it is turning left or right, or tilting forward or backwards.
13	Calibrate	When they drone continue to flying to one direction without control the joystick, put the drone on the ground again and press this button to calibrate the gyroscope to let it fly stable.
14	Power Button	Long Press to power on or power off your drone.

6. Inserting Batteries Into Your Remote Control

Use a screwdriver (included) to open up the battery compartment located on the rear of your remote control.

Insert 3 AA 1.5V batteries (not included), making sure that the batteries are inserted with the correct polarity (+,-) as displayed in the battery compartment.

Once the batteries are inserted, put the battery compartment cover back on the battery compartment, and use a screwdriver to close it securely.

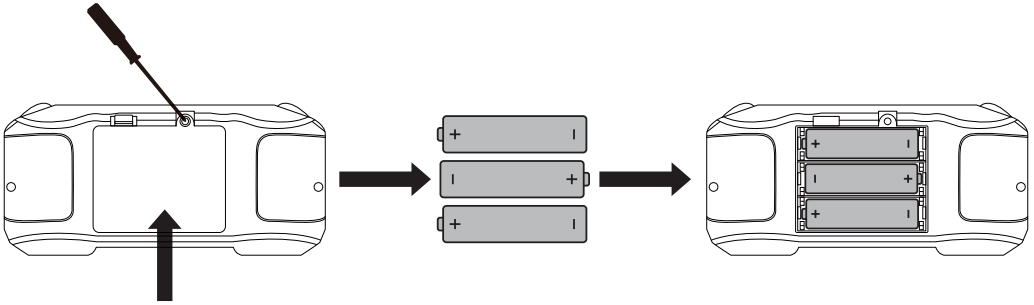

- Do not mix rechargeable and non-rechargeable batteries.
- Do not mix old and new batteries or different types of batteries.
- Remove exhausted batteries and dispose of them based on the rules of your local municipality.
- Remove the batteries from your remote control if it will not be in use for an extended period of time.

7. Charging Your Drone's Battery

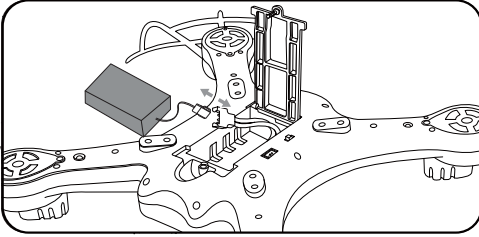

Open the drone's battery compartment and remove the battery.

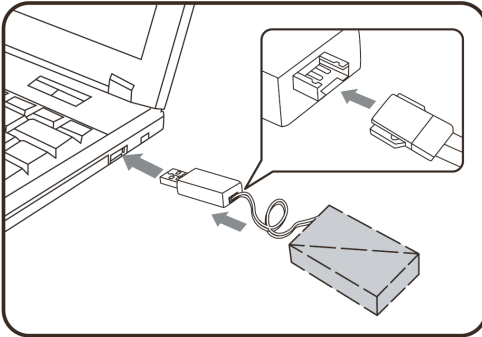

Connect the battery to the included charger. Then plug the charger into a USB charging adapter (not included). For best results, use a 5V, 1-2A charger to charge the battery.

The charger has an LED light indicator. While charging, the LED light on the charger will be red. This light will be off once charging is complete.

Once fully charged, connect the battery's cable to the cable in the battery compartment. Then put the battery back in the battery compartment and close the cover.

WARNING:

1. The charging plug can overheat if overcharged. If this occurs unplug the charger immediately to avoid damaging the battery.
2. Do not leave the battery unattended when charging.
3. Do not use other chargers other than the one supplied.
4. Wait at least 30 minutes after using your drone before charging the battery. The battery's temperature can become elevated during use and charging it immediately could damage the battery.
5. Remove the drone's battery when the drone is not in use. Store it in a cool dry place.
6. Do not leave the battery exposed to excessive heat, flame or fire.
7. Do not short circuit the battery. Do not leave the battery in contact with any metal parts.
8. Cancer and reproductive Harm-www.P65Warnings.ca.gov

8. Installing Landing Legs/Landing Guards

Install the landing legs (included) to the bottom of your drone.

There are sockets at the bottom of the drone to attach the landing legs. Insert the landing legs as shown in the illustration below. To secure the landing legs with the screws

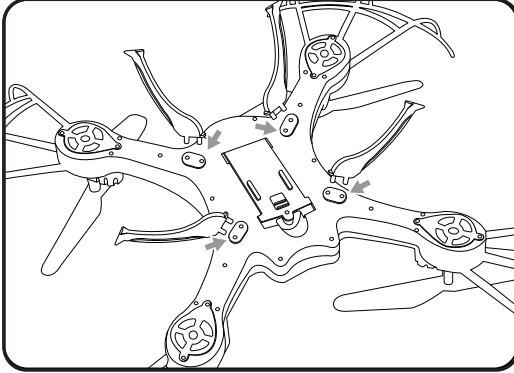

9. Installing Camera

Install the camera (included) to the bottom of your drone.

Step1: Insert the camera as shown in the illustration below.

Step2: Insert the cable to the port of bottom of drone as shown in the illustration below.

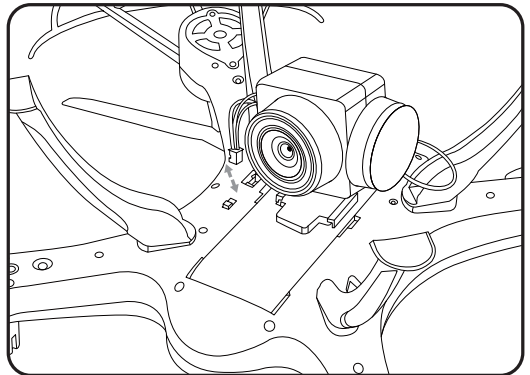
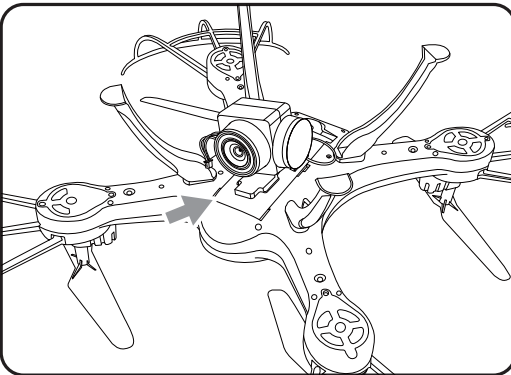

10. Synchronizing Your Remote and Drone

To power on your drone, make sure that the battery is inserted and fully charged. Slide the power switch located at the rear of the drone to the 'on' position to turn your drone on. Follow the steps below in order to synchronize your drone and remote control for flight.

Press the power button on your remote control, Push the throttle stick all the way up, and then pull it all the way down, next, push the remote control stick to top again. The indicator lights on your remote and drone will flash when powered on and then stop flashing and shine steadily when both are synchronized.

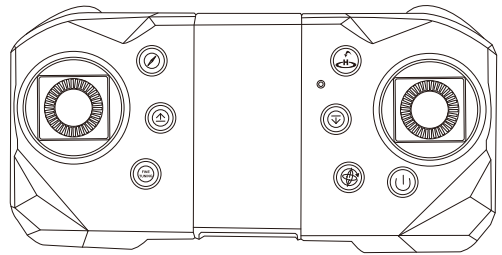

11. Connect your camera

App name: XXXX

Download the APP from Google store or App store by search the name of APP
Find the wifi signal,(wifi name:xxxx) from your smart phone, connect it and click
“Start”on App homepage.







You can record video or take photo also by click the button on the APP or you can use
the Remote control to take photo or record video

12. Flying Your Drone

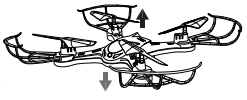
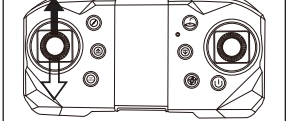
Pre-Flight Preparation

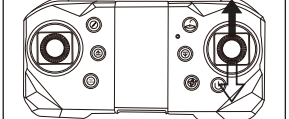
If you have never used a drone before and you are not an experienced pilot, make sure to read these instructions carefully before flying. Get familiar with all of the controls. If necessary, read through these instructions many times and practice handling the remote control until you feel completely comfortable and ready.

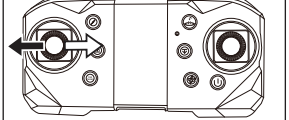
1. Place your drone in a clear, open field. Make sure that it is resting on a secure, flat surface.
2. Practice using the throttle stick and the directional control stick (see below).
3. By simulating the use of the remote and both sticks, you will grow more comfortable with the natural motions required during flight and you will learn to react more rapidly to unexpected circumstances.

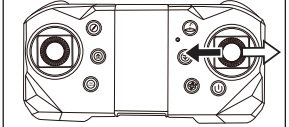
<p>Ascend & Descend</p>	<p>Push the throttle stick upwards and the drone will ascend.</p> <p>Pull the throttle stick downwards and the drone will descend.</p>		
<p>Forward & Backward</p>	<p>Push the directional control stick upwards and the drone will tilt downwards, causing it to move forward. Push the directional control stick downwards and the drone will tilt upwards, causing it to move backwards.</p>		
<p>Turn</p>	<p>Slide the throttle stick to the left to turn the nose of the drone, turning it to the left. Slide the throttle stick to the right and the nose of the drone will turn to the right.</p>		
<p>Slide Left & Slide Right</p>	<p>Slide the directional control stick to the left and the entire body of the drone will slide to the left.</p> <p>Slide the directional control stick to the right and the entire body of the drone will slide to the right.</p>		

13. Speed Adjustment

Your drone has three speed settings (Low, Medium, High). Press the Speed button on the top left side of your remote control to adjust the speed at which your drone flies.

14. 3-D Flips

Your drone can perform 3-D flips using the flip button and the directional control stick.

To perform a flip, make sure your drone is at least 3 meters above ground, then press the flip button while pushing the directional control stick in one direction. The drone will flip

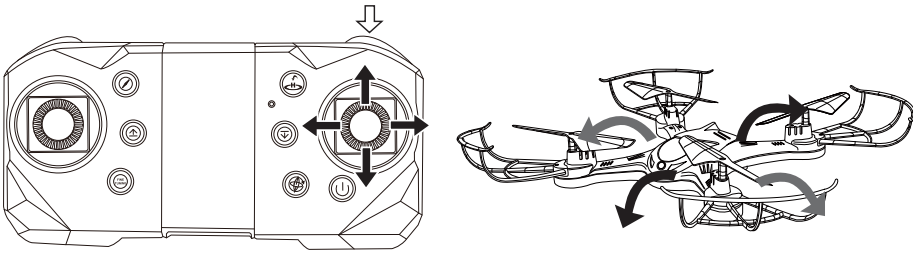

15. Fine-Tuning

If your drone seems to be flying uncontrollably or in a disoriented way. Press and hold the Fine-Tuning button until you hear a beep, then push the directional lever in the opposite direction that your drone is flying in until the drone holds still. This will help calibrate the drone so that it will fly correctly.

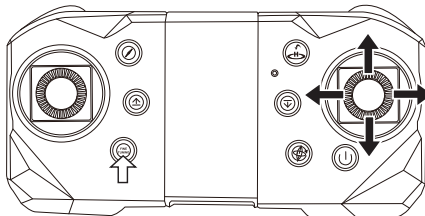

16. One Key Return

One Key Return allows your drone to return to its take-off coordinates with the push of a button. To activate, press the One Key Return button and use the left control stick to adjust the altitude of your drone. Once your aircraft is within visible and controllable range, push the directional lever in any direction to exit return mode.

17. Headless Mode

Headless mode allows you to fly your drone without worrying about the drone's orientation. Regardless of which way the drone is facing, this function ensures that the drone will always follow controls from your perspective all the time.

To enter Headless mode, after your drone takes off, stand in front of your drone and press the Headless mode button on your remote control. The lights on your drone will blink slowly. **press the Headless mode button on your remote control. You should hear a beep to indicate that headless mode is enabled, and the drone's indicator light will slowly blink. To quit headless mode, press the headless mode button again, and once again you will hear a beep to indicate that headless mode is disabled.**

18. Propeller Blade Installation

If you need to replace the propeller blades (extras not included), use a screwdriver and twist counterclockwise to remove the screw holding the propeller blade. Place the propeller blade in the correct blade position "A"/"B" that corresponds with the illustrations below. Twist the screw down in a clockwise direction to secure the propeller blades.

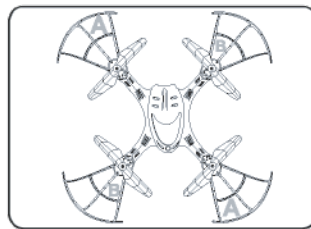
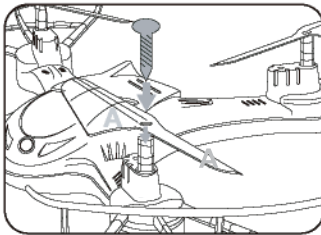

FCC Compliance Statement

Changes or modifications not expressly approved by the party responsible for compliance could void the user's authority to operate the equipment.

This device complies with Part 15 of the FCC Rules. Operation is subject to the following two conditions: (1) this device may not cause harmful interference, and (2) this device must accept any interference received, including interference that may cause undesired operation.

This equipment has been tested and found to comply with the limits for a Class B digital device, pursuant to Part 15 of the FCC Rules. These limits are designed to provide reasonable protection against harmful interference in a residential installation. This equipment generates, uses and can radiate radio frequency energy and, if not installed and used in accordance with the instructions, may cause harmful interference to radio communications. However, there is no guarantee that interference will not occur in a particular installation.

If this equipment does cause harmful interference to radio or television reception, which can be determined by turning the equipment off and on, the user is encouraged to try to correct the interference by one or more of the following measures:

- Reorient or relocate the receiving antenna.
- Increase the separation between the equipment and receiver.
- Connect the equipment into an outlet on a circuit different from that to which the receiver is connected.
- Consult the dealer or an experienced radio/TV technician for help.

CSI One Year Warranty

This warranty covers the original consumer purchaser only and is not transferable.

This warranty covers products that fail to function properly UNDER NORMAL USAGE, due to defects in material or workmanship. Your product will be repaired or replaced at no charge for parts or labor for a period of one year.

What Is Not Covered by Warranty

Damages or malfunctions not resulting from defects in material or workmanship and damages or malfunctions from other than normal use, including but limited to, repair by unauthorized parties, tampering, modification or accident.

To Obtain Warranty Service and Troubleshooting Information:

Call 1-800-592-9541 for 24/7 Support

To receive Warranty service along with the name and address of an authorized product service center, the original consumer purchaser must contact us for problem determination and service procedures. Proof of purchase in the form of a bill of sale or receipted invoice, evidencing that the product is within the applicable Warranty period(s), MUST be presented in order to obtain the requested service. It is your responsibility to properly package and send any defective products along with a dated copy of proof of purchase, a written explanation of the problem, and a valid return address to the authorized service center at your expense. Do not include any other items or accessories with the defective product. Any products received by the authorized service center that are not covered by warranty will be returned unrepaired.



2023 CSI
Edison, NJ 08817
Tech Support
800 592 9541

©SEGA. All rights reserved. SEGA is registered in the U.S. Patent and Trademark Office. SEGA and SONIC THE HEDGEHOG are either registered trademarks or trademarks of SEGA CORPORATION.