

# Automatic Pet Feeder

## Video Type Operation Guide



# Safety Instruction

- 1.Children need to be used in the company of adults;
- 2.Do not use the feeder with pets that cannot reach the food tray or have any physical disabilities.
- 3.Do not immerse the base part in water at any time, because this will damage the control panel and other electronic components.
- 4.Do not place any foreign objects in the pet feeder.
- 5.Do not use canned, wet food.
- 6.Do not disassemble the device in a manner over than the instructions in this user guide.
- 7.Do not modify the pet feeder.
- 8.If the equipment is malfunctioning or damaged, please do not try to repair the pet feeder by yourself, contact the seller immediately and solve it
- 9.Always unplug the power plug when not in use and before cleaning.
- 10.If the power plug gets wet, turn off the power to the outlet. Don't try to unplug the power plug.

# Notice

- 1.Do not allow pets to chew or swallow any part. If you are worried about the power cord, please purchase a wire guide (hard plastic protector) at hardware store to protect the power cord.
- 2.Do not install or store pet feeders in places where they will be exposed to weather or temperatures below -10° C~40°C .
- 3.Use alkaline Size D battery for power supply. Do not use rechargeable batteries.
- 4.Check the battery regularly. Before leaving for a long time be sure to replace the battery with a new one.
- 5.Do not lift pet feeders with lids, food buckets and food bowl. carry or move with both hands and the base should keeping the device in an upright position.
- 6.Only support dry food, the size range is 2-12 mm in diameter. Larger foods will get stuck at the food outlet.
- 7.Please read and follow all important instructions listed on the pet feeder and packaging.

# Product Image

### Front View

- 1.Food Tank Lid
- 2.Food Tank
- 3.Control Panel
- 4.Food Outlet
- 5.Body
- 6.Food Bowl
- 7.Camera

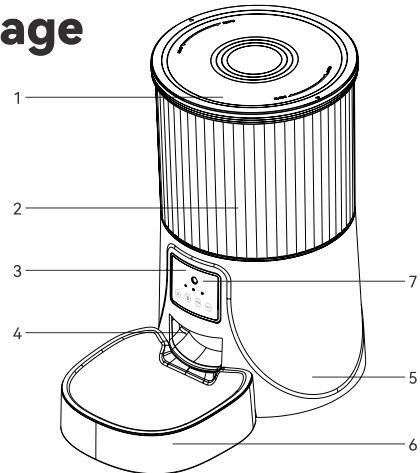

### Bottom View

- 8.Speaker
- 9.Battery Compartment
- 10.DC Interface

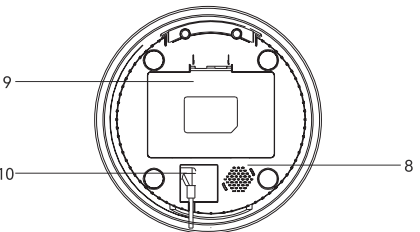

# Button Description

- 📹 Recording: Press and hold for 1 second to start recording with a beep, when hear two beeps to end recording.The feeder only support up to 10 seconds recording.  
Delete recording: Long press for 1 second to make a beep, release the recording button for 1 second , and end the recording when you hear two beeps.  
(In fact, a short period of blank recording is to replace recording)
- 🔒 Lock/unlock: long press for 6 seconds and the red indicator light flashes 2 times to lock the machine, long press again for 6 seconds and the red indicator light flashes 2 times to unlock.  
In the locked state, you can press and hold the SET button to restore the factory settings.
- 🍽 Manual feeding: short press to serve 1 portion, there are recordings and 2 recordings are played at the same time.
- 🔄 Reset: Press and hold for 7 seconds to make a "ding dong" sound, and the device will automatically restart after restoring the factory settings (the red light flashes quickly for 7 to 10 seconds and then goes out, the blue light is always on for 10 to 15 seconds and then flashes).

### Indicator light (blue light)

- 1.Flashing: waiting for the distribution network
- 2.Steady on: The network connection is successful
- 3.Power on, WiFi quick connection/AP mode switch: always on for 6 seconds

### Indicator light (red light)

- 1.Flashing: abnormal detection of limit switch (motor does not rotate)
- 2.Lock/unlock: Flashing twice
- 3.Power on, WiFi quick connection/AP mode switch: always on for 6 seconds

# Cleaning and Maintenance

- Please clean the feeder regularly to keep your pet's health.  
When it starts to get dirty and a lot of loose food in the food trough, you can remove the food cover to clean it.  
Use a soft damp cloth to clean the base of the feeder and the control panel. Do not get wet this part, and do not to clean it with running water.  
Do not put the product in the dishwasher, otherwise it will be permanently damaged!

# Packing List

- After opening the product package, please confirm whether the machine is in good condition.  
Please check the list to confirm whether the accessories are complete.  
The Feeder\*1  
Adapter\*1  
Power Cord\*1  
Product Manual\*1

# Specification

- Food Tank Capacity:4L  
Power supply: DC 5V/1A power adapter; 3pcs alkaline Size D Battery  
Power adapter: AC110~240V input, DC5V output  
G.W:1.75KG  
Size: 18.4\*18.4\*31.9cm

# Warranty

- We provide a 1-year warranty for this device. If you have any questions, please contact the seller. We will get back to you as soon as possible.

# FCC WARNING

- This device complies with part 15 of the FCC Rules. Operation is subject to the follow ing two conditions : (1) this device may not cause harmful interference, and (2) this device must accept any interference received,inc luding interference that may cause undesired operation.  
Any changes or modifications not expressly approved by the party responsible for compliance could void the user's authority to operate the equipment.  
NOTE:This equipment has been tested and found to comply with the limits for a Class B digital device, pursuant to Part 15 of the FCC Rules. These limits are designed to provide reasonable protection against harmful interference in a residential installation. This equipment generates, uses and can radiate radio frequency energy and, if not installed and used in accordance with the instructions, may cause harmful interference to radio communications. However, there is no guarantee that interference will not occur in a particular installation. If this equipment does cause harmful interference to radio or televis ion reception, which can be determined by turning the equipment off and on, the user is encouraged to try to correct the interference by one or more of the following measures:  
-- Reorient or relocate the receiving antenna.  
-- Increase the separation between the equipment and receiver.  
-- Connect the equipment into an outlet on a circuit different from that to which the receiver is connected.  
-- Consult the dealer or an experienced radio/TV technic ian for help.  
To maintain compliance with FCC's RF Exposure guidelines, This equipment should be installed and operated with minimum distance between 20cm the radiator your body: Use only the supplied antenna.

Please Read the Manual Carefully Before Using the Product

# Instructions

## 01 | Installation

- Remove the feeder from the box.
- Place the feeder in the suitable location.
- Combine the food tray with the base of the feeder.

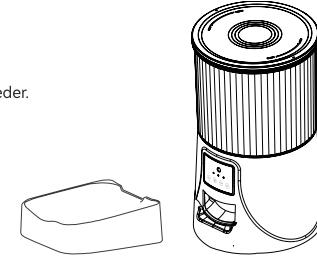

## 02 | Connect the power supply

- Plug the 5V/1A power adapter into the wall socket and connect the device.
- Open the battery compartment at the bottom of the feeder and install 3 pcs Size D Battery (not necessary) to prevent power failure. The LED light is on to indicate that the feeder is powered on.

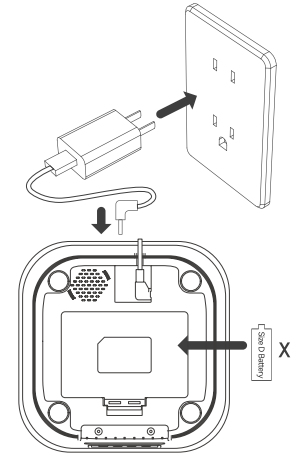

Note:

- Does not including battery.
- Before turning on the power, make sure that all parts are clean and completely dry.

## 03 | Put pet food in food tank

- Fill the food tank with dry pet food. Close the lid and it will snap into place due to gravity.

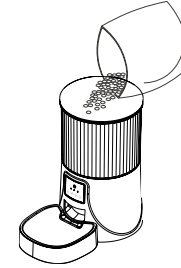

Note:

- Do not use canned, wet or damp pet food.
- The recommended pet food size range is 2-12 mm.

## 04 | Recording

- Press and hold the recording button for 1 seconds until you hear a beep and start recording, and hear two beeps to end the recording. The feeder support up to 10 seconds recording, and you can repeat this process to change your recording.



Note:

- It will play only when it is pressed when there is a recording.
- when the feeding time it will play the recording twice.

## 05 | Lock/Unlock

- Long press for 6 seconds the red indicator light flashes 2 times to lock the button, and long press again for 6 seconds the red indicator light flashes 2 times to unlock the button.
- In the locked state, you can press and hold the SET button to restore the factory settings



Note:

- Pressing the recording and feeding buttons in the locked state does not work, and it must be unlocked for normal use.
- The operation of the APP is not affected when it is locked.

## 06 | Feeding

- Manual feeding: short press to serve 1 portion, and will play the recording 2 times at the same time.

Note:

The feeding plan will not be affected.



## 07 | Reset

- Press and hold for 7 seconds to make a "ding dong" sound, and the device will automatically restart after restoring the factory settings (the red light flashes quickly for 7 to 10 seconds and then goes out, and the blue light stays on for 10 to 15 seconds before flashing).



# Smart Life APP specific operations



1. Scan the QR code to download the exclusive APP, register an account and log in



2. Enter the main interface of the APP and add a device



3. Manually Add-Small Appliances-IPC Pet Feeder



4. Confirm the device indicator is flashing, then next step



5. Enter the WIFI password. Note that the name and password do not contain Chinese characters and special symbols, and 5GWIFI is not supported.



6. Keep the QR code facing the feeder camera at a distance of 10-15cm

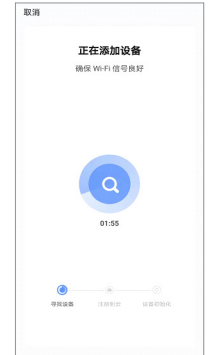

7. Wait for the device to connect to the network

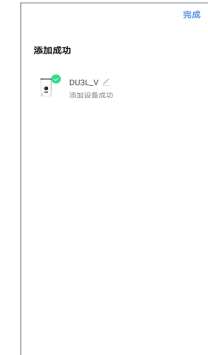

8. The addition is successful, you can give a name to the feeder

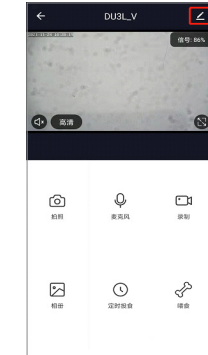

9. Choose to feed regularly and set up a feeding plan



10. Add timing, set feeding time and number of meals



11. Select the time, repeat the selection to every day, and select the number of servings per meal



12. Click the mark in the upper right corner of step 9 to enter the device settings

# Troubleshooting

## Problem solution

- Q: Cannot be configured
- A: WiFi name and password do not use Chinese, no more than 12 digits, please use a combination of numbers and letters, 5GWIFI signal is not supported, please use 2.4GWIFI signal.
- Some software conflicts in the phone also cause the connection to fail. Please restart the phone, close the non-system software started with the phone, turn on the phone's Bluetooth and location, and try to reconnect.

- Q: The feeder is inaccurate or unable to feed
- A: Please check whether there is too much food in the food pan and whether the food passage is blocked, and clean the food outlet and food passage. When using battery power, please check whether the battery is dead or leaking

- Q: The feeder is offline
- A: Please check the distance between the feeder and the router at home, not more than 10 meters, and try not to divide the wall in between. According to the WiFi characteristics, the WiFi signal of the partition wall will drop sharply, causing the connection to be unstable and offline.

- Q: No response after boot
- A: First check whether the power is plugged in and whether the switch is turned on. If they are all plugged in, please check whether the power adapter and power cord are damaged, and contact customer service.

## Hotspot distribution network (optional)

- The specific steps are as follows:
- Open the Smart Life APP, select Add Device-Manual Add-Small Home Appliances-Pet Feeder (Wi-Fi)-Enter WiFi Password Next-Wi-Fi Quick Connect in the upper right corner is changed to "Hot Spot Network (Compatible Mode)" Next step-then connect to the WiFi signal of SmartLife-XXXX.
  - After connecting, return to the previous interface, and then enter the network configuration interface to wait for the connection.