

Automatic Pet Feeder

Smart Type Operation Guide



Please Read the Manual Carefully
Before Using the Product

Safety Instruction

- 1.Children need to be used in the company of adults;
- 2.Do not use the feeder for pets who cannot reach the food tray or have physical disabilities.
- 3.Do not immerse the base part in water, which will damage electronic components such as control panel.
- 4.Do not place any foreign objects in the pet feeder.
- 5.Do not put canned, wet or wet food in the feeder.
- 6.Do not disassemble the equipment by yourself.
- 7.Do not modify the pet feeder.
- 8.If the equipment has faults or damaged accessories, do not try to repair the pet feeder by yourself. Contact the seller immediately and solve it.
- 9.Be sure to unplug the power plug when not using the product or cleaning the product.
- 10.If the power plug of the equipment is damp, please turn off the power of the socket and do not try to unplug the power plug.

Notice

- 1.Do not let your pet chew or swallow any accessories. If you are worried about the power cord, please buy wire conduit (hard plastic protector) and protect the power cord at the hardware store.
- 2.Do not install or put the pet feeder in an exposed place. The temperature should be within the range of 0 °C~40 °C.
- 3.Please use alkaline Size D battery for power supply. Do not use rechargeable batteries.
- 4.Check the battery regularly. If you travel or travel for a long time, be sure to replace the battery.
- 5.Do not lift the pet feeder directly with the cover, food bucket and food tray. Hold the base with both hands to lift and carry, while keeping the device in an upright position.
- 6.Only applicable to dry food with a diameter of 3-13mm. Larger foods may get stuck or block the Food Outlet.
- 7.Please carefully read and follow all important instructions listed on the pet feeder and package.

Open The Box

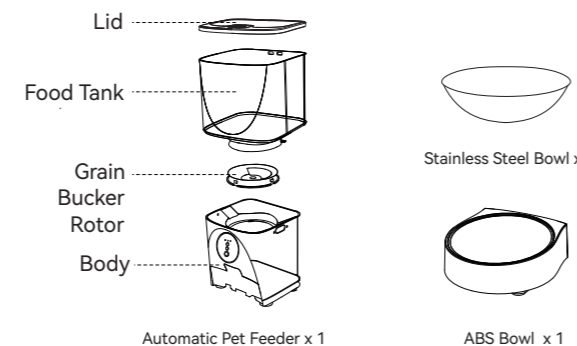

Automatic Pet Feeder x 1



Stainless Steel Bowl x 1



ABS Bowl x 1

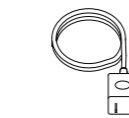

Power Adapter x 1



Desiccant Bag x 1

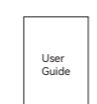

User Guide Kit x 1

Installation

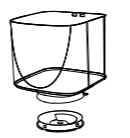

1.Take out all accessories from the box

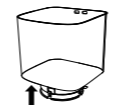

2.Align the rotor and the food tank in the marked location (right-angle bayonets align with large grooves), then rotate clockwise to lock

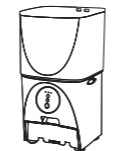

3.Assemble the food tank and the base, and buckle the lock on both sides



4.Put the desiccant bag into the desiccant box under the Lid.

Note:
To prevent mold growth, it is recommended to change the desiccant bag every 15 days. Remove the desiccant bag before cleaning the lid.

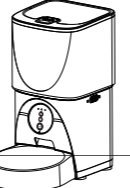

5.Finally, combine the food bowl with the body.

Product Image

Front View

- 1.Button To Open Cover
- 2.Food Tank Lid
- 3.Food Tank
- 4.Control Panel
- 5.Food Outlet
- 6.Body
- 7.Food Bowl

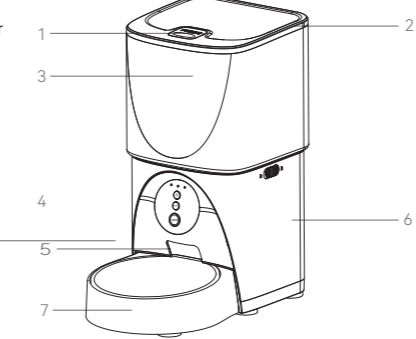

Bottom View

- 8.Speaker
- 9.Battery Compartment
- 10.DC Interface

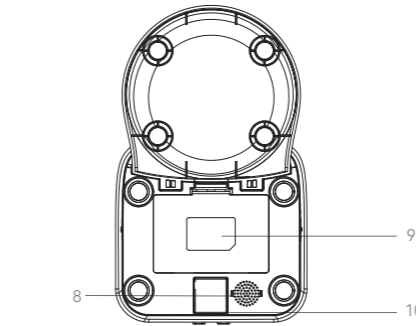

Button Description

Recording button: Long press for 1s until you hear "di" and start recording. The recording time does not exceed 10s. After you release your hand, you will hear "didi" to indicate that it has been saved.

Delete recording: Long press 1s to hear "di", then press 1s to release the recording button when hear "didi" to end recording. (It is actually used no recording to cover the old recording)

Reset (switching the network configuration mode):

When the power is turned on and the network is not configured, the blue indicator flashes quickly by default (WiFi quick connection configuration mode), press and hold for 7 seconds to hear three beeps. The red/blue indicator is always on for 6 seconds and then switches to slow flashing (hot spot network configuration mode). Repeat the operation to switch between the two network modes.

FEED:

Manual feeding: Short press to serve 1 portion, and the recording will be played once.
lock/unlock: under unlock state, Long press for 6 seconds and the red indicator light flashes twice to lock the machine, then long press again for 6 seconds and the red indicator light flashes 2 times to unlock.

In the locked state, you can press and hold the SET button to restore the factory settings.

Indicator light (blue light)

1. Fast flashing: flashing twice in 1 second, WiFi quick connection mode
2. Slow flashing: flashing once every 3 seconds, AP hotspot network configuration mode
3. Steady on: The network connection is successful
4. Power on, WiFi quick connection/AP mode switch: always on for 6 seconds

Indicator light (red light)

1. Flashing: abnormal detection of limit switch (motor does not rotate)
2. Lock/unlock: flash twice
3. Power on, WiFi quick connection/AP mode switch: always on for 6 seconds

Cleaning and Maintenance

Please clean the feeder regularly to keep your pet's health.
When it starts to get dirty and a lot of loose food in the food trough, you can remove the food cover to clean it.
Clean the feeder base containing the control panel with a soft, damp cloth.
Do not wet this part. Remember not to rinse it directly with running water.
Do not put the product in the dishwasher, otherwise it will be permanently damaged!

Specification

Food Tank Capacity: 4L
Power supply: DC 5V/1A power adapter; 3pcs alkaline batteries
Power adapter: AC110-240V input, DC5V output
N.G: 1.54KG
Size: 18.9*17.5*34cm
BC-061-D

Model: DU4L-WQ, DU4L-W, DU6L-W, DU5L-WH, DU7L-WH, PLAF101, PLAF102

FCC WARNING

This device complies with part 15 of the FCC Rules. Operation is subject to the following two conditions: (1) this device may not cause harmful interference, and (2) this device must accept any interference received, including interference that may cause undesired operation.

Any changes or modifications not expressly approved by the party responsible for compliance could void the user's authority to operate the equipment.

NOTE: This equipment has been tested and found to comply with the limits for a Class B digital device, pursuant to Part 15 of the FCC Rules. These limits are designed to provide reasonable protection against harmful interference in a residential installation. This equipment generates, uses and can radiate radio frequency energy and, if not installed and used in accordance with the instructions, may cause harmful interference to radio communications.

However, there is no guarantee that interference will not occur in a particular installation. If this equipment does cause harmful interference to radio or television reception, which can be determined by turning the equipment off and on, the user is encouraged to try to correct the interference by one or more of the following measures:

- Reorient or relocate the receiving antenna.
- Increase the separation between the equipment and receiver.
- Connect the equipment into an outlet on a circuit different from that to which the receiver is connected.
- Consult the dealer or an experienced radio/TV technician for help.

To maintain compliance with FCC's RF Exposure guidelines, This equipment should be installed and operated with minimum distance between 20cm and your body. Use only the supplied antenna.

Instructions

01 | Connect the power supply

- ⊗ Plug the 5V/1A power adapter into the wall socket and connect the device.
- ⊗ Open the battery compartment at the bottom of the feeder and install 3 pcs D size batteries (not necessary) to prevent power failure
- ⊗ The display will automatically light up, indicating that the feeder is turned on.

Note:
Before turning on the power, make sure that all parts are clean and completely dry.

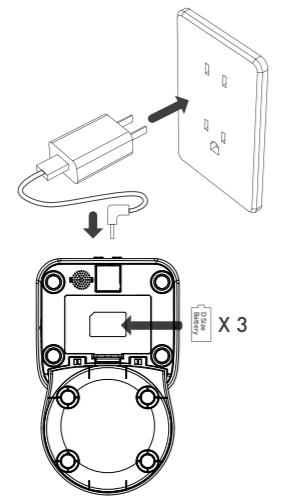

02 | Put pet food in food tank

- ⊗ Fill the food tank with dry pet food.
- To close the lid, press and hold the lid open button, align the side clips, and release the lid lid button to secure the food bucket and lid together.
- Note:
Do not place canned, wet or wet pet food.
The recommended pet food size range is 3-13 mm.

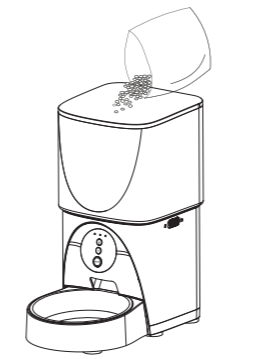

03 | Recording

- ⊗ Long press for 1s until you hear "di" and start recording. The recording time does not exceed 10s. After you release your hand, you will hear "didi" to indicate that it has been saved. If you are not satisfied, you can repeat this step to replace the previous recording.
- note:

- 1) Recording will be played by pressing the recording button
- 2) Recording will be played when feeding

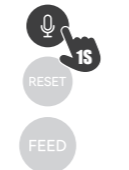

04 | Lock/unlock button

- ⊗ under unlock state, Long press for 6 seconds and the red indicator light flashes twice to lock the machine, then long press again for 6 seconds and the red indicator light flashes 2 times to unlock.
- In the locked state, you can press and hold the SET button to restore the factory settings
- note:
Pressing the feeding button in the locked state does not work, it must be unlocked for normal use.
The APP operation is not affected in the locked state.

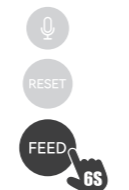

05 | Feeding

- ⊗ Manual feeding: short press to serve 1 portion.
- note:
The feeding plan will not be affected



06 | Reset

- ⊗ Switching the network configuration mode: When the power is turned on and the network is not configured, the blue indicator flashes quickly by default (WiFi quick connection configuration mode), press and hold for 7 seconds to hear three beeps, The red/blue indicator is always on for 6 seconds and then switches to slow flashing (hot spot network configuration mode). Repeat the operation to switch between the two network modes.



Smart Life APP specific operations



1. Download the App, register a dedicated account and log in

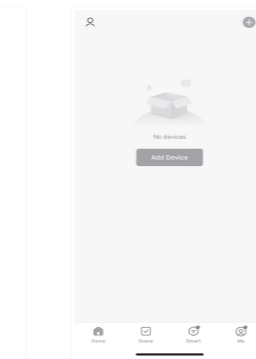

2. Enter the App and click "Add Device"

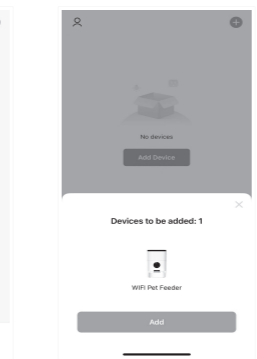

3. First open your phone Bluetooth and allow permissions. After entering the interface, wait for the device to be discovered automatically, then click "add"

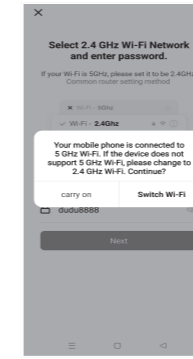

4. Enter the WiFi password. Note that the name and password do not contain Chinese or special symbols, and support 5GWiFi.

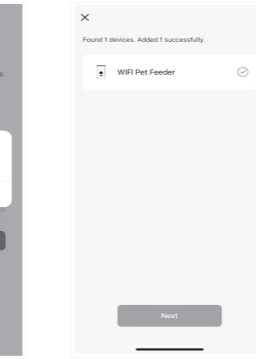

5. Waiting for the device to connect the network, showing successfully added, then next step

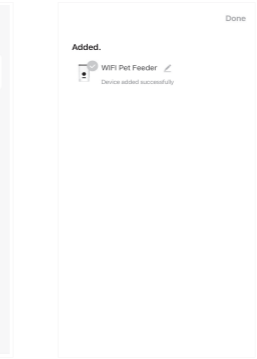

6. After successful, you can customize the name of device, click on the upper right corner to finish this step.

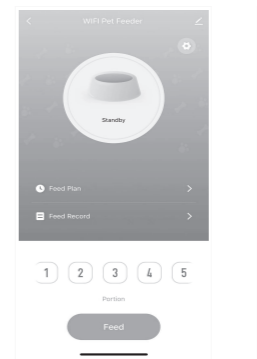

7. Enter the main interface, you can choose the meals and portions as needed, click "Feeding" to feeding immediately

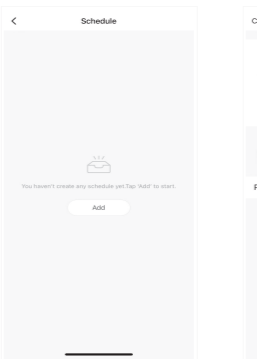

8. Click on the Main Interface "Feeding Plan" to add feeding schedule

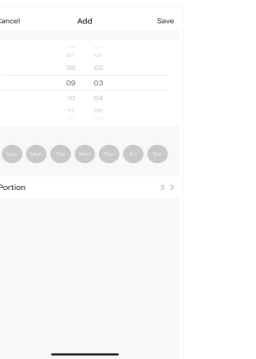

9. You can set the time and the number of meals according to the pet's eating pattern, set it to choose from Monday to Sunday every day, and click Save.

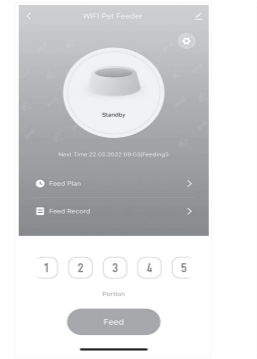

10. Steps of sharing equipment: main interface. Click the icon in the upper right corner to enter the settings option

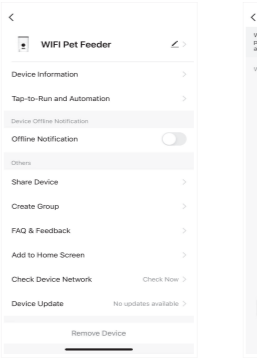

11. Enter the settings menu option and click "Share Devices"

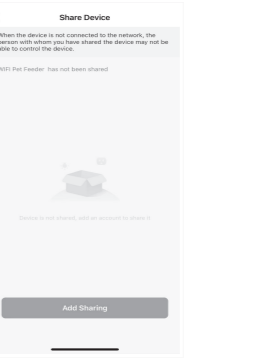

12. Click "Add Share" and enter the other party's APP account to share the device with multiple people

Troubleshooting

Question Answer

- Q: Cannot be configured
- A: 1) WiFi name and password should not be in Chinese, and should not exceed 12 digits. Please use a combination of numbers and letters to support 2.4G/5G WiFi signals.
2) Some software conflicts in the mobile phone will also cause the network connection to fail. Please restart the mobile phone, close the non-system software that starts automatically when you turn it on, turn on the mobile phone's Bluetooth and positioning, and then try to reconnect.

- Q: The feeder is inaccurate or unable to feed
- A: Please check whether there is too much food on the food tray and whether the food outlet is blocked; usually clean the food outlet and food channel in time; when using battery power, please check whether the battery is dead and whether the battery is leaking.

- Q: The feeder displays offline
- A: Please check whether the distance between the feeder and the router at home is more than 10 meters (effective distance is 10 meters); try not to partition the wall in the middle. According to the WiFi characteristics, the WiFi signal of the partition wall will drop sharply, and the connection will become unstable, which will cause the product to be offline.

- Q: No response when turn on the feed
- A: First check that the movie is plugged in and the switch is on. If they are all plugged in, please check whether the power adapter and power cord are damaged, and contact customer service for handling.

Hotspot distribution network (optional)

- Please follow the button instructions to switch the network distribution mode to hot distribution network, the LED light flashes slowly, the specific operation steps are as follows:
1. Open the Smart Life APP, select Add Device - Manually Add - Small Appliances - Pet Feeder (Wi-Fi) - Enter the WiFi Password Next - Click "Next", select Slow Flash - Click "Connect" - then go to connect SmartLife-XXXX WiFi signal.
 2. After connecting, return to the previous interface, and then enter the network configuration interface to wait for the connection.