

Antenna Description:

Antenna type	FPC antenna
Model	014.02.X301.0127
Frequency range	2400MHz~2500MHz/5150~5850MHz
Manufacturer	Shenzhen B&T Technology Co., LTD
Address	No.408, Block C, Huafeng Smart Innovation Port, Gushu 2nd Road, Xixiang Street, Baoan District, Shenzhen

Antenna Photo

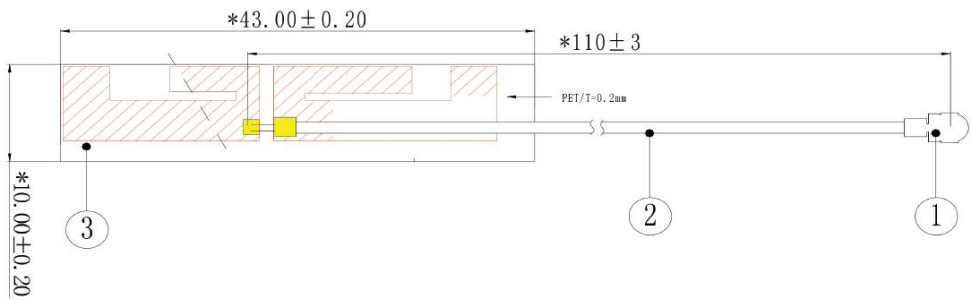

S11 Parameter

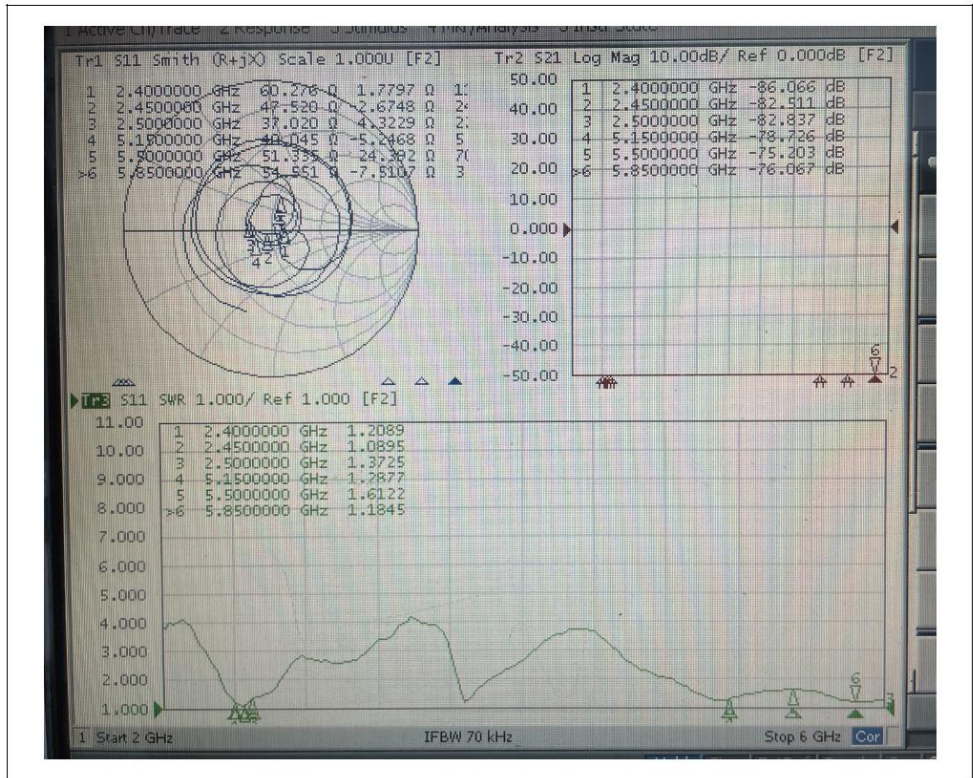

Freq/MHz	2400MHz	2450MHz	2500MHz	5150MHz	5500MHz	5850MHz
VSWR	1.20	1.08	1.37	1.28	1.61	1.18

Antenna Efficiency and Gain:

Frequency (MHz)	Gain (dBi)	Efficiency (%)
2400.0	1.36	49.29
2410.0	1.25	49.33
2420.0	1.34	49.26
2430.0	1.51	50.19
2440.0	1.47	50.02
2450.0	1.46	49.92
2460.0	1.54	50.24
2470.0	1.73	50.88
2480.0	1.90	51.19
2490.0	2.07	52.16
2500.0	2.23	53.75
5150.0	2.63	50.61
5200.0	2.90	49.50
5250.0	2.83	50.45
5300.0	2.98	50.91
5350.0	3.19	54.91
5400.0	3.59	55.44
5450.0	3.86	54.68
5500.0	4.18	56.88
5550.0	3.72	54.65
5600.0	3.54	52.31
5650.0	2.99	54.75
5700.0	3.02	52.71
5750.0	2.87	54.01
5800.0	2.93	52.51
5850.0	2.96	55.41

2400M 3D-E1-E2-H

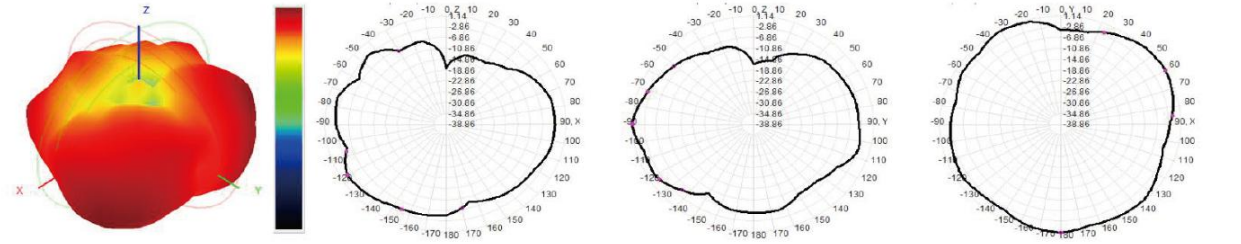

2450M 3D-E1-E2-H

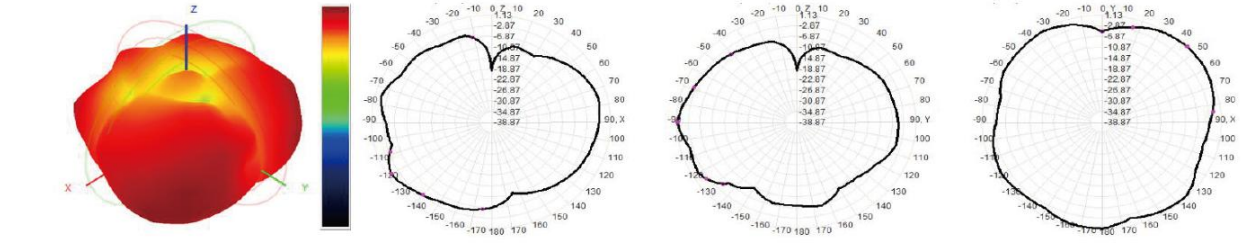

2500M 3D-E1-E2-H

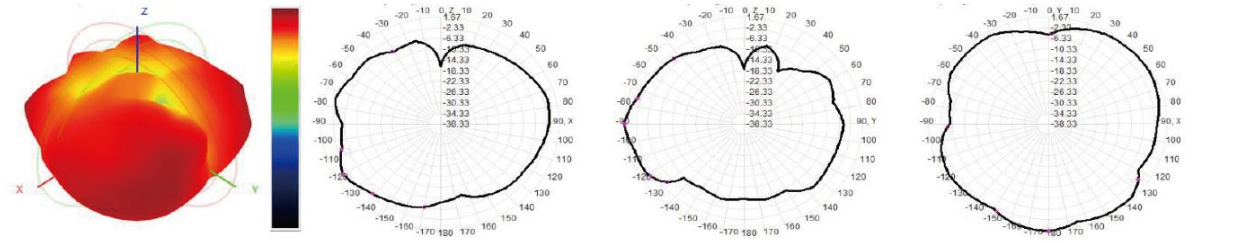

5150M 3D-E1-E2-H

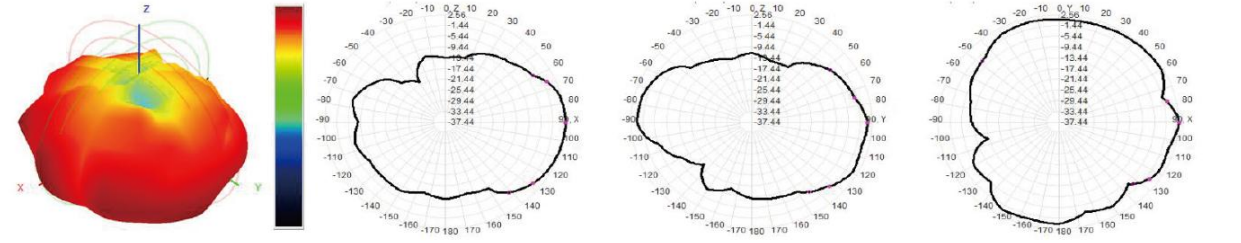

5500M 3D-E1-E2-H

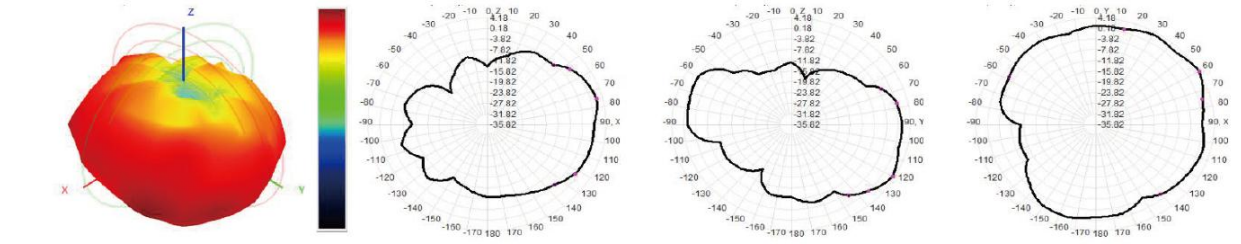

5850M 3D-E1-E2-H

