

TEST REPORT

Report No...... : **KS2207S2887E01**
FCC ID..... : **2A54U-DTXMAX**
Applicant..... : **Shenzhen Xinkeying Technology Co.,Ltd**
Address..... : 8/F,Block C,Han's Innovation Building,Xili Road, Nanshan
Distric,Shenzhen,China
Manufacturer..... : Shenzhen Xinkeying Technology Co.,Ltd
Address..... : 8/F,Block C,Han's Innovation Building,Xili Road, Nanshan
Distric,Shenzhen,China
Product Name..... : **Smart watch**
Trade Mark..... : DTNO.1
Model/Type reference..... : DTX Max,DTX Max+,DTX Max Pro+,DTX Max mini,DTX Max Pro
Standard..... : **FCC 15.247**
Date of Receipt..... : July 04, 2022
Date of Test Date..... : July 04, 2022~July 11, 2022
Date of issue..... : July 11, 2022
Test result..... : **Pass**

Prepared by: Pai Zheng
(Printed name + Signature)

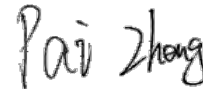

Approved by: Sky Dong
(Printed name + Signature)



Testing Laboratory Name..... : **KSIGN(Guangdong) Testing Co., Ltd.**
Address..... : West Side of 1/F., Building C, Zone A, Fuyuan New Factory, Jiujiu
Industrial Park, Minzhu,Shatou, Shajing, Bao'an District, Shenzhen,
Guangdong, China

This test report may be duplicated completely for legal use with the approval of the applicant. It should not be reproduced except in full, without the written approval of our laboratory. The client should not use it to claim product endorsement by KSIGN. The test results in the report only apply to the tested sample. The test report shall be invalid without all the signatures of testing engineers, reviewer and approver. Any objections must be raised to KSIGN within 15 days since the date when the report is received. It will not be taken into consideration beyond this limit. The test report merely correspond to the test sample.

TABLE OF CONTENTS**Page**

1. TEST SUMMARY	3
1.1. TEST STANDARDS	3
1.2. REPORT VERSION	3
1.3. TEST DESCRIPTION	4
1.4. TEST FACILITY	5
1.5. MEASUREMENT UNCERTAINTY	6
1.6. ENVIRONMENTAL CONDITIONS	6
2. GENERAL INFORMATION	7
2.1. GENERAL DESCRIPTION OF EUT	7
2.2. OPERATION STATE	8
2.3. MEASUREMENT INSTRUMENTS LIST	9
2.4. TEST SOFTWARE	10
2.5. ANCILLARY EQUIPMENT LIST	10
2.6. DESCRIPTION OF SUPPORT UNITS	10
3. TEST ITEM AND RESULTS	11
3.1. ANTENNA REQUIREMENT	11
3.2. CONDUCTED EMISSION	12
3.3. SPURIOUS EMISSION (RADIATED)	15
3.4. BAND EDGE EMISSIONS(RADIATED)	26
3.5. PEAK OUTPUT POWER	31
3.6. POWER SPECTRAL DENSITY	35
3.7. 6dB BANDWIDTH	40
3.8. DUTY CYCLE	44
3.9. CONDUCTED BAND EDGE	47
3.10. SPURIOUS RF CONDUCTED EMISSION	49
4. EUT TEST PHOTOS	51
5. PHOTOGRAPHS OF EUT CONSTRUCTIONAL	53

1. TEST SUMMARY

1.1. Test Standards

The tests were performed according to following standards:

FCC Rules Part 15.247: Operation within the bands of 902-928MHz, 2400-2483.5MHz, and 5725-5850MHz.

KDB 558074 D01 15.247 Meas Guidance v05r02: The measurement guidance provided herein is applicable only to Digital Transmission System (DTS) devices operating in the 902-928 MHz, 2400-2483.5 MHz and/or 5725-5850 MHz bands under §15.247 of the FCC rules (Title 47 of the Code of Federal Regulations)

ANSI C63.10-2020: American National Standard for Testing Unlicensed Wireless Devices.

1.2. Report Version

Revised No.	Date of issue	Description
01	July 11, 2022	Original

1.3. Test Description

FCC Part 15 Subpart C(15.247)			
Test Item	Standard Section	Result	Test Engineer
	FCC		
Antenna Requirement	15.203	Pass	Cyril Cai
Conducted Emission	15.207	Pass	Cyril Cai
Radiated Emission	15.205&15.209	Pass	Cyril Cai
Radiated Band Edge	15.205&15.247(d)	Pass	Cyril Cai
Peak Output Power	15.247(b)	Pass	Cyril Cai
Power Spectral Density	15.247(e)	Pass	Cyril Cai
6dB Bandwidth	15.247(a)(2)	Pass	Cyril Cai
Duty Cycle	558074 D01 15.247 Meas Guidance v05r02 Chapter 6	Pass	Cyril Cai
Conducted Band edge	15.247(d)	Pass	Cyril Cai
Spurious RF Conducted Emission	15.247(d)	Pass	Cyril Cai

Note:

The measurement uncertainty is not included in the test result.

1.4. Test Facility

Address of the report laboratory

KSIGN(Guangdong) Testing Co., Ltd.

West Side of 1/F., Building C, Zone A, Fuyuan New Factory, Jiujiu Industrial Park, Minzhu, Shatou, Shajing, Bao'an District, Shenzhen, Guangdong, China

Laboratory accreditation

The test facility is recognized, certified, or accredited by the following organizations:

CNAS-Lab Code: L13261

KSIGN(Guangdong) Testing Co., Ltd. has been assessed and proved to be in Compliance with CNAS-CL01 Accreditation Criteria for Testing and Calibration Laboratories (identical to ISO/IEC17025: 2017 General Requirements) for the Competence of Testing and Calibration Laboratories.

A2LA-Lab Cert. No.: 5457.01

KSIGN(Guangdong) Testing Co., Ltd. EMC Laboratory has been accredited by A2LA for technical Competence in the field of electrical testing, and proved to be in compliance with ISO/IEC 17025:2017 General Requirements for the Competence of Testing and Calibration Laboratories and any additional program requirements in the identified field of testing.

ISED#: 25693 CAB identifier.: CN0096

KSIGN(Guangdong) Testing Co., Ltd. has been listed by Innovation, Science and Economic Development Canada to perform electromagnetic emission measurement.

FCC-Registration No.: 294912 Designation Number: CN1328

KSIGN(Guangdong) Testing Co., Ltd. EMC Laboratory has been listed on the US Federal Communications Commission list of test facilities recognized to perform electromagnetic emissions measurements.

1.5. Measurement Uncertainty

The data and results referenced in this document are true and accurate. The reader is cautioned that there may be errors within the calibration limits of the equipment and facilities. The measurement uncertainty was calculated for all measurements listed in this test report acc. to TR-100028-01” Electromagnetic compatibility and Radio spectrum Matters (ERM);Uncertainties in the measurement of mobile radio equipment characteristics; Part 1” and TR-100028-02 “Electromagnetic compatibility and Radio spectrum Matters (ERM);Uncertainties in the measurement of mobile radio equipment characteristics; Part 2 “ and is documented in the KSIGN(Guangdong) Testing Co., Ltd. system acc. to DIN EN ISO/IEC 17025. Furthermore, component and process variability of devices similar to that tested may result in additional deviation. The manufacturer has the sole responsibility of continued compliance of the device. Below is the best measurement capability for KSIGN(Guangdong) Testing Co., Ltd.

Test Items	Measurement Uncertainty	Notes
Transmitter power conducted	0.42 dB	(1)
Transmitter power Radiated	2.14 dB	(1)
Conducted spurious emissions 9kHz~40GHz	1.60 dB	(1)
Radiated spurious emissions 9kHz~40GHz	2.20 dB	(1)
Conducted Emissions 9kHz~30MHz	3.20 dB	(1)
Radiated Emissions 30~1000MHz	4.70 dB	(1)
Radiated Emissions 1~18GHz	5.00 dB	(1)
Radiated Emissions 18~40GHz	5.54 dB	(1)
Occupied Bandwidth	2.80 dB	(1)

Note (1): This uncertainty represents an expanded uncertainty expressed at approximately the 95% confidence level using a coverage factor of k=1.96.

1.6. Environmental Conditions

During the measurement the environmental conditions were within the listed ranges:

Temperature:	15~35°C
Relative Humidity:	30~60 %
Air Pressure:	950~1050mba

2. GENERAL INFORMATION

2.1. General Description Of EUT

Test Sample Number 1:	1-1-1(Normal Sample),1-1-2(Engineering Sample)
Product Name:	Smart watch
Trade Mark:	DTNO.I
Model/Type reference:	DTX Max,DTX Max+,DTX Max Pro+,DTX Max mini,DTX Max Pro
Model Difference:	The difference between the product model is only the appearance is not the same, the different model name is for the market demand. Other power supply mode, internal structure, circuit and key components are the same, does not affect the safety and electromagnetic compatibility performance.
Power supply:	INPUT: AC 120V~60Hz, 34W
Hardware Version:	V1.0
Software Version:	V1.0.0
Bluetooth	
Modulation:	GFSK
Operation frequency:	2402MHz~2480MHz
Max Output Power:	5.68dBm
Channel number:	40
Channel separation:	2MHz
Antenna type:	Internal Antenna
Antenna gain:	-0.7dBi

2.2. Operation State

Operation Frequency List: The EUT has been tested under typical operating condition. The Applicant provides communication tools software to control the EUT for staying in continuous transmitting and receiving mode for testing. 40 channels are provided to the EUT. Channels 00/19/39 were selected for testing.

BLE Operation Frequency List:

Channel	Frequency (MHz)
00	2402
01	2404
:	:
19	2440
20	2442
21	2444
:	:
38	2478
39	2480

Note: The display in grey were the channel selected for testing.

Test Channel

Channel	Channel	Frequency (MHz)
Low	00	2402
Middle	19	2440
High	39	2480

Test mode

NO.	TEST MODE DESCRIPTION
1	Low channel TX (2402MHz)
2	Middle channel TX (2440MHz)
3	High channel TX (2480MHz)

Note:

1. Only the result of the worst case was recorded in the report, if no other cases.
2. The test software is the RTLBTAPP Version: 5.2.2.98 which can set the EUT into the individual test modes.

2.3. Measurement Instruments List

Tonscend JS0806-2 Test system					
Item	Test Equipment	Manufacturer	Model No.	Serial No.	Cal. Until
1	Spectrum Analyzer	R&S	FSV40-N	101798	03/04/2023
2	Vector Signal Generator	Agilent	N5182A	MY50142520	03/04/2023
3	Analog Signal Generator	HP	83752A	3344A00337	03/04/2023
4	Power Sensor	Agilent	E9304A	MY50390009	03/04/2023
5	Power Sensor	Agilent	E9300A	MY41498315	03/04/2023
6	Wideband Radio Communication Tester	R&S	CMW500	157282	03/04/2023
7	Climate Chamber	Angul	AGNH80L	1903042120	03/04/2023
8	Dual Output DC Power Supply	Agilent	E3646A	MY40009992	03/04/2023
9	RF Control Unit	Tonscend	JS0806-2	/	03/04/2023

Radiated Emission					
Item	Test Equipment	Manufacturer	Model No.	Serial No.	Cal. Until
1	EMI Test Receiver	R&S	ESR	102525	03/04/2023
2	High Pass Filter	Chengdu E-Microwave	OHF-3-18-S	0E01901038	03/04/2023
3	High Pass Filter	Chengdu E-Microwave	OHF-6.5-18-S	0E01901039	03/04/2023
4	Spectrum Analyzer	HP	8593E	3831U02087	03/04/2023
5	Ultra-Broadband logarithmic period Antenna	Schwarzbeck	VULB 9163	01230	12/04/2023
6	Loop Antenna	Beijin ZHINAN	ZN30900C	18050	03/04/2023
7	Spectrum Analyzer	R&S	FSV40-N	101798	03/04/2023
8	Horn Antenna	Schwarzbeck	BBHA 9120 D	2023	03/29/2023
9	Pre-Amplifier	Schwarzbeck	BBV 9745	9745#129	03/04/2023
10	Pre-Amplifier	EMCI	EMC051835SE	980662	03/04/2023

Conducted Emission					
Item	Test Equipment	Manufacturer	Model No.	Serial No.	Cal. Until
1	LISN	R&S	ENV432	1326.6105.02	03/04/2023
2	EMI Test Receiver	R&S	ESR	102524	03/04/2023
3	Manual RF Switch	JS TOYO	/	MSW-01/002	03/04/2023

Note:

- 1)The Cal. Interval was one year.
- 2)The cable loss has calculated in test result which connection between each test instruments.

TRF No. FCC Part 15.247_R1

Add : West Side of 1/F., Building C, Zone A, Fuyuan New Factory, Jiujiu Industrial Park, Minzhu, Shatou, Shajing, Bao'an District, Shenzhen, Guangdong, China

Tel : +(86) 0755-2985 2678 Fax: +(86) 0755-2985 2397 E-mail : info@gdksign.cn Web: www.gdksign.com

2.4. Test Software

Software name	Model	Version
Conducted emission Measurement Software	EZ-EMC	EMC-Con 3A1.1
Radiated emission Measurement Software	EZ-EMC	FA-03A.2.RE
Bluetooth and WIFI Test System	JS1120-3	2.5.77.0418

2.5. Ancillary Equipment list

Equipment	Model	S/N	Manufacturer	Certificate type
/	/	/	/	/

2.6. Description Of Support Units

The EUT has been tested as an independent unit together with other necessary accessories or support units. The following support units or accessories were used to form a representative test configuration during the tests.

Item	Equipment	Brand	Model/Type No.	Series No.	Note
1	Adapter	/	GA-QC810	/	
2	USB Cable	/	/	/	

Note:

1. The support equipment was authorized by Declaration of Confirmation.
2. For detachable type I/O cable should be specified the length in cm in 『Length』 column.

3. TEST ITEM AND RESULTS

3.1. Antenna Requirement

Requirement

FCC CFR Title 47 Part 15 Subpart C Section 15.203:

An intentional radiator shall be designed to ensure that no antenna other than that furnished by the responsible party shall be used with the device. The use of a permanently attached antenna or of an antenna that uses a unique coupling to the intentional radiator, the manufacturer may design the unit so that a broken antenna can be replaced by the user, but the use of a standard antenna jack or electrical connector is prohibited.

FCC CFR Title 47 Part 15 Subpart C Section 15.247(c) (1)(i):

(i) Systems operating in the 2400~2483.5 MHz band that is used exclusively for fixed. Point-to-point operations may employ transmitting antennas with directional gain greater than 6dBi provided the maximum conducted output power of the intentional radiator is reduced by 1 dB for every 3 dB that the directional gain of the antenna exceeds 6dBi.

Test Result

The antenna gain is -0.7dB, the directional gain of the antenna less than 6dBi. It comply with the standard requirement. In case of replacement of broken antenna the same antenna type must be used.

Antenna structure please refer to the EUT internal photographs antenna photo.

3.2. Conducted Emission

Limit

Conducted Emission Test Limit

Frequency	Maximum RF Line Voltage (dB μ V)	
	Quasi-peak Level	Average Level
150kHz~500kHz	66 ~ 56 *	56 ~ 46 *
500kHz~5MHz	56	46
5MHz~30MHz	60	50

Notes:

1. *Decreasing linearly with logarithm of the frequency.
2. The lower limit shall apply at the transition frequencies.
3. The limit decrease in line with the logarithm of the frequency in the range of 0.15 to 0.50MHz.

Test Configuration

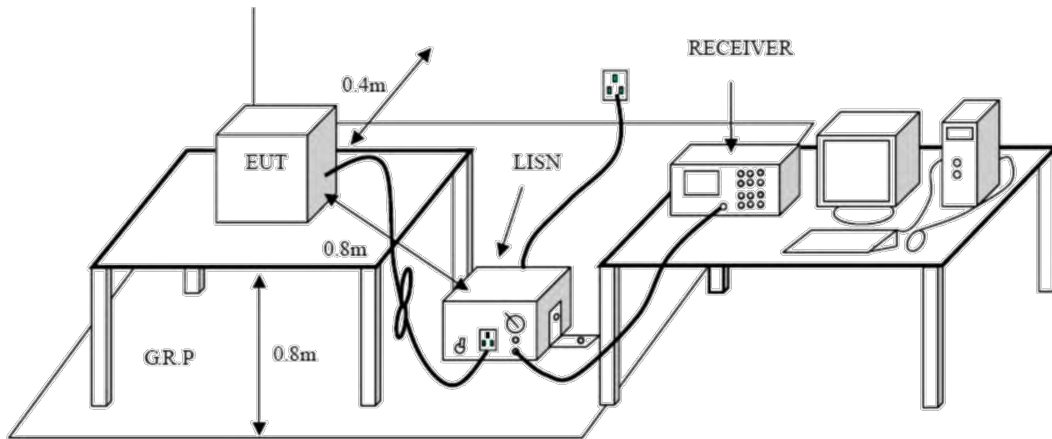

Test Procedure

1. The EUT was setup according to ANSI C63.10:2020 requirements.
2. The EUT was placed on a platform of nominal size, 1 m by 1.5 m, raised 80 cm above the conducting ground plane. The vertical conducting plane was located 40 cm to the rear of the EUT. All other surfaces of EUT were at least 80 cm from any other grounded conducting surface.
3. The EUT and simulators are connected to the main power through a line impedances stabilization network (LISN). The LISN provides a 50ohm /50uH coupling impedance for the measuring equipment. The peripheral devices are also connected to the main power through a LISN. (Please refer to the block diagram of the test setup and photographs)
4. Each current-carrying conductor of the EUT power cord, except the ground (safety) conductor, was individually connected through a LISN to the input power source.
5. The excess length of the power cord between the EUT and the LISN receptacle were folded back and forth at the center of the lead to form a bundle not exceeding 40 cm in length.
6. Conducted Emissions were investigated over the frequency range from 0.15MHz to 30MHz using a receiver bandwidth of 9 kHz.
7. During the above scans, the emissions were maximized by cable manipulation.

Test Mode:

Please refer to the clause 2.2.

Test Results

Remark:

- Both modes of BLE 1Mbps and 2Mbps were tested at Low, Middle, and High channel; only the worst result of BLE 1Mbps was reported as below:
- Both 120 VAC, 50/60 Hz power supply have been tested, only the worst result of 120 VAC, 60 Hz was reported as below:

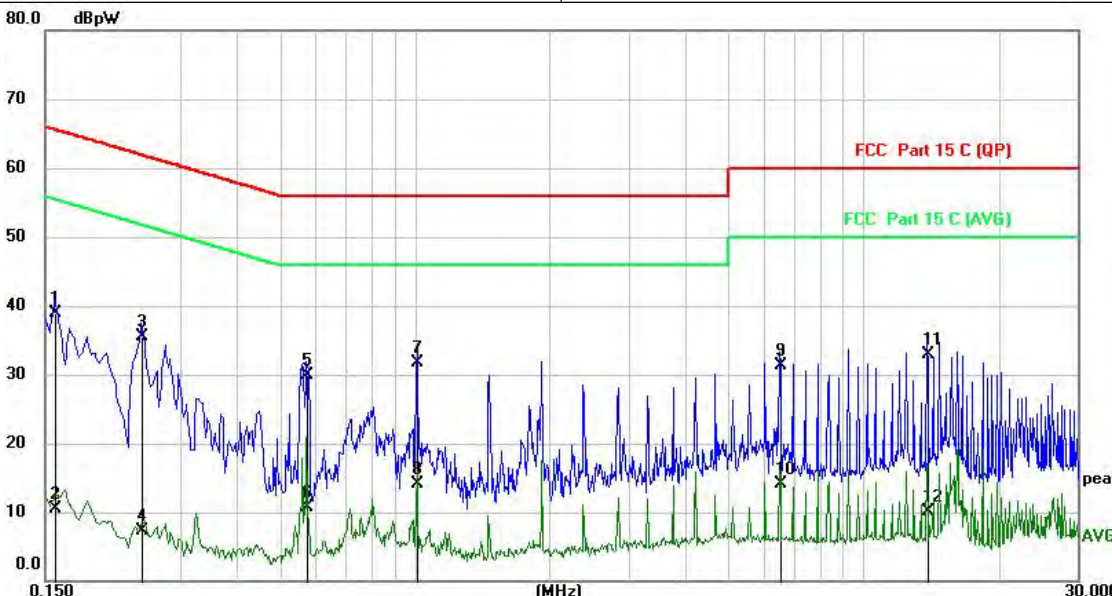
Test Voltage:	AC 120V/60Hz																																																																																																																					
Terminal:	Line																																																																																																																					
																																																																																																																						
<table border="1" style="width:100%; border-collapse: collapse;"> <thead> <tr> <th>No.</th> <th>Mk.</th> <th>Freq. MHz</th> <th>Reading Level dBpW</th> <th>Correct Factor dB</th> <th>Measure- ment dBpW</th> <th>Limit dBpW</th> <th>Over dB</th> <th>Detector</th> </tr> </thead> <tbody> <tr><td>1</td><td></td><td>0.1580</td><td>28.16</td><td>10.71</td><td>38.87</td><td>65.57</td><td>-26.70</td><td>QP</td></tr> <tr><td>2</td><td></td><td>0.1580</td><td>-0.13</td><td>10.71</td><td>10.58</td><td>55.57</td><td>-44.99</td><td>AVG</td></tr> <tr><td>3</td><td></td><td>0.2460</td><td>24.75</td><td>10.73</td><td>35.48</td><td>61.89</td><td>-26.41</td><td>QP</td></tr> <tr><td>4</td><td></td><td>0.2460</td><td>-3.51</td><td>10.73</td><td>7.22</td><td>51.89</td><td>-44.67</td><td>AVG</td></tr> <tr><td>5</td><td></td><td>0.5740</td><td>19.45</td><td>10.45</td><td>29.90</td><td>56.00</td><td>-26.10</td><td>QP</td></tr> <tr><td>6</td><td></td><td>0.5740</td><td>0.32</td><td>10.45</td><td>10.77</td><td>46.00</td><td>-35.23</td><td>AVG</td></tr> <tr><td>7</td><td>*</td><td>1.0140</td><td>21.23</td><td>10.50</td><td>31.73</td><td>56.00</td><td>-24.27</td><td>QP</td></tr> <tr><td>8</td><td></td><td>1.0140</td><td>3.62</td><td>10.50</td><td>14.12</td><td>46.00</td><td>-31.88</td><td>AVG</td></tr> <tr><td>9</td><td></td><td>6.5219</td><td>20.78</td><td>10.59</td><td>31.37</td><td>60.00</td><td>-28.63</td><td>QP</td></tr> <tr><td>10</td><td></td><td>6.5219</td><td>3.50</td><td>10.59</td><td>14.09</td><td>50.00</td><td>-35.91</td><td>AVG</td></tr> <tr><td>11</td><td></td><td>13.8820</td><td>22.20</td><td>10.74</td><td>32.94</td><td>60.00</td><td>-27.06</td><td>QP</td></tr> <tr><td>12</td><td></td><td>13.8820</td><td>-0.56</td><td>10.74</td><td>10.18</td><td>50.00</td><td>-39.82</td><td>AVG</td></tr> </tbody> </table>		No.	Mk.	Freq. MHz	Reading Level dBpW	Correct Factor dB	Measure- ment dBpW	Limit dBpW	Over dB	Detector	1		0.1580	28.16	10.71	38.87	65.57	-26.70	QP	2		0.1580	-0.13	10.71	10.58	55.57	-44.99	AVG	3		0.2460	24.75	10.73	35.48	61.89	-26.41	QP	4		0.2460	-3.51	10.73	7.22	51.89	-44.67	AVG	5		0.5740	19.45	10.45	29.90	56.00	-26.10	QP	6		0.5740	0.32	10.45	10.77	46.00	-35.23	AVG	7	*	1.0140	21.23	10.50	31.73	56.00	-24.27	QP	8		1.0140	3.62	10.50	14.12	46.00	-31.88	AVG	9		6.5219	20.78	10.59	31.37	60.00	-28.63	QP	10		6.5219	3.50	10.59	14.09	50.00	-35.91	AVG	11		13.8820	22.20	10.74	32.94	60.00	-27.06	QP	12		13.8820	-0.56	10.74	10.18	50.00	-39.82	AVG
No.	Mk.	Freq. MHz	Reading Level dBpW	Correct Factor dB	Measure- ment dBpW	Limit dBpW	Over dB	Detector																																																																																																														
1		0.1580	28.16	10.71	38.87	65.57	-26.70	QP																																																																																																														
2		0.1580	-0.13	10.71	10.58	55.57	-44.99	AVG																																																																																																														
3		0.2460	24.75	10.73	35.48	61.89	-26.41	QP																																																																																																														
4		0.2460	-3.51	10.73	7.22	51.89	-44.67	AVG																																																																																																														
5		0.5740	19.45	10.45	29.90	56.00	-26.10	QP																																																																																																														
6		0.5740	0.32	10.45	10.77	46.00	-35.23	AVG																																																																																																														
7	*	1.0140	21.23	10.50	31.73	56.00	-24.27	QP																																																																																																														
8		1.0140	3.62	10.50	14.12	46.00	-31.88	AVG																																																																																																														
9		6.5219	20.78	10.59	31.37	60.00	-28.63	QP																																																																																																														
10		6.5219	3.50	10.59	14.09	50.00	-35.91	AVG																																																																																																														
11		13.8820	22.20	10.74	32.94	60.00	-27.06	QP																																																																																																														
12		13.8820	-0.56	10.74	10.18	50.00	-39.82	AVG																																																																																																														
<p>Remarks:</p> <p>1.Measurement = Reading Level+ Correct Factor</p> <p>2.Over = Measurement -Limit</p>																																																																																																																						

TRF No. FCC Part 15.247_R1

Add : West Side of 1/F., Building C, Zone A, Fuyuan New Factory, Jiujiu Industrial Park, Minzhu, Shatou, Shajing, Bao'an District, Shenzhen, Guangdong, China

Tel : +(86) 0755-2985 2678 Fax: +(86) 0755-2985 2397 E-mail : info@gdksign.cn Web: www.gdksign.com

Test Voltage:	AC 120V/60Hz
Terminal:	Neutral

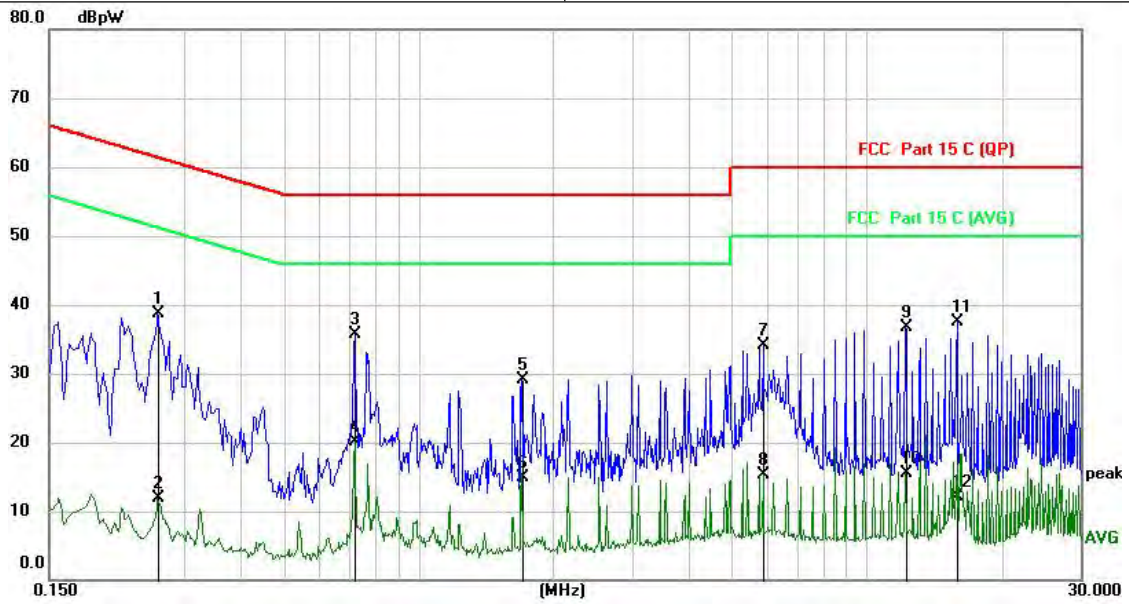

No.	Mk.	Freq. MHz	Reading Level dBpW	Correct Factor dB	Measure- ment dBpW	Limit dBpW	Over dB	Detector
1		0.2620	28.09	10.66	38.75	61.37	-22.62	QP
2		0.2620	1.17	10.66	11.83	51.37	-39.54	AVG
3	*	0.7220	25.22	10.43	35.65	56.00	-20.35	QP
4		0.7220	9.74	10.43	20.17	46.00	-25.83	AVG
5		1.7020	18.54	10.53	29.07	56.00	-26.93	QP
6		1.7020	4.39	10.53	14.92	46.00	-31.08	AVG
7		5.8780	23.53	10.59	34.12	60.00	-25.88	QP
8		5.8780	4.80	10.59	15.39	50.00	-34.61	AVG
9		12.2100	25.99	10.67	36.66	60.00	-23.34	QP
10		12.2100	4.90	10.67	15.57	50.00	-34.43	AVG
11		15.8860	26.79	10.79	37.58	60.00	-22.42	QP
12		15.8860	1.24	10.79	12.03	50.00	-37.97	AVG

Remarks:

1.Measurement = Reading Level+ Correct Factor

2.Over = Measurement -Limit

3.3. Spurious Emission (Radiated)

Limit

Radiated Emission Limits (9 kHz~1000 MHz)

Frequency (MHz)	Field Strength (microvolt/meter)	Measurement Distance (meters)
0.009~0.490	2400/F(KHz)	300
0.490~1.705	24000/F(KHz)	30
1.705~30.0	30	30
30~88	100	3
88~216	150	3
216~960	200	3
Above 960	500	3

Radiated Emission Limit (Above 1000MHz)

Frequency (MHz)	Distance Meters(at 3m)	
	Peak	Average
Above 1000	74	54

Note:

1. The tighter limit applies at the band edges.
2. Emission Level (dBuV/m)=20log Emission Level (uV/m).

Test Configuration

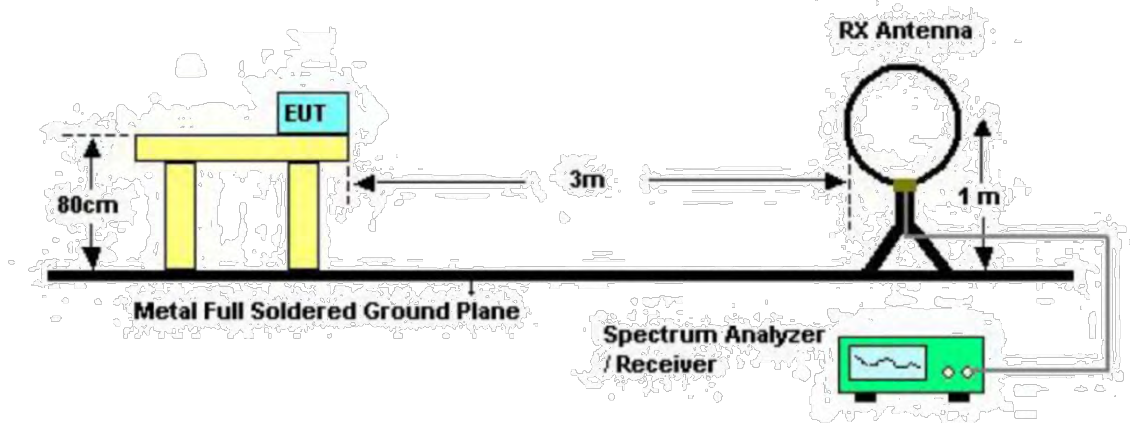

Below 30MHz Test Setup

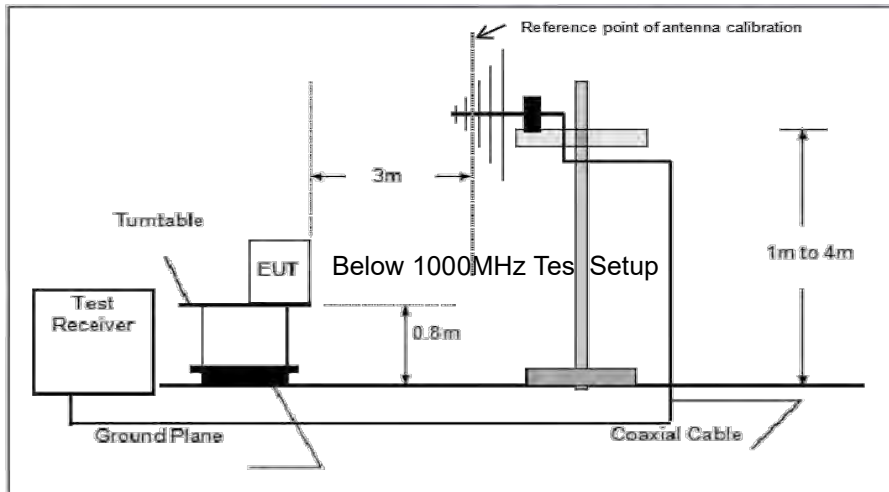

Below 1000MHz Test Setup

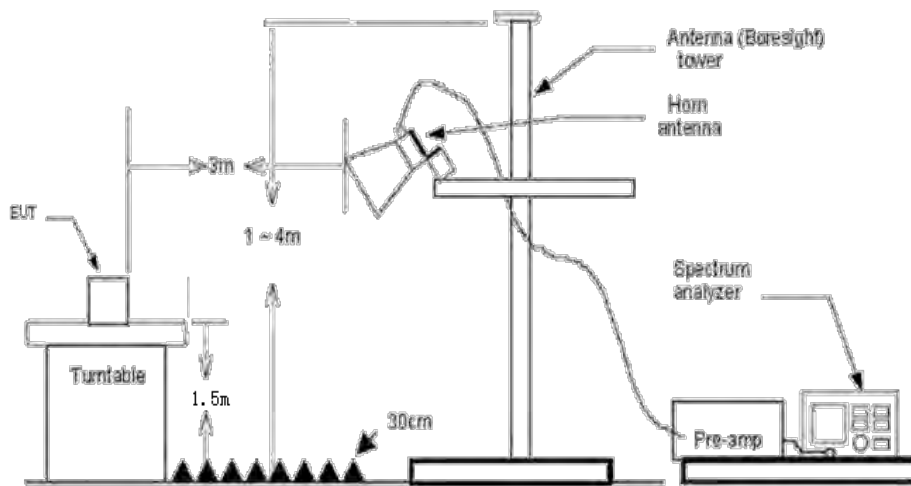

Above 1GHz Test Setup

Test Procedure

1. The EUT was setup and tested according to ANSI C63.10:2020
2. The EUT is placed on a turn table which is 0.8 meter above ground for below 1 GHz, and 1.5 m for above 1 GHz. The turn table is rotated 360 degrees to determine the position of the maximum emission level.
3. The EUT was set 3 meters from the receiving antenna, which was mounted on the top of a variable height antenna tower.
4. For each suspected emission, the EUT was arranged to its worst case and then tune the Antenna tower (from 1 m to 4 m) and turntable (from 0 degree to 360 degrees) to find the maximum reading. A pre-amp and a high pass filter are used for the test in order to get better signal level to comply with the guidelines.
5. Set to the maximum power setting and enable the EUT transmit continuously.
6. Use the following spectrum analyzer settings
 - (1) Span shall wide enough to fully capture the emission being measured;
 - (2) Below 1 GHz:
RBW=120 kHz, VBW=300 kHz, Sweep=auto, Detector function=peak, Trace=max hold;

If the emission level of the EUT measured by the peak detector is 3 dB lower than the applicable limit, the peak emission level will be reported. Otherwise, the emission measurement will be repeated using the quasi-peak detector and reported.

(3) From 1 GHz to 10th harmonic:

RBW=1MHz, VBW=3MHz Peak detector for Peak value.

RBW=1MHz, VBW=10Hz Peak detector for Peak value.

Test Mode

Please refer to the clause 2.2.

Test Result

Remark:

1. This test was performed with EUT in X, Y, Z position and the worse case was found when EUT in X position.
2. Both modes of BLE 1Mbps and 2Mbps were tested at Low, Middle, and High channel and recorded worst mode at BLE 1Mbps.

9 KHz - 30 MHz

the amplitude of spurious emissions which are attenuated by more than 20dB below the permissible value has no need to be reported.

30MHz - 1GHz

Test voltage:	DC 3.7V
Ant. Pol.:	Horizontal
Test Mode:	TX BLE Mode 2402MHz

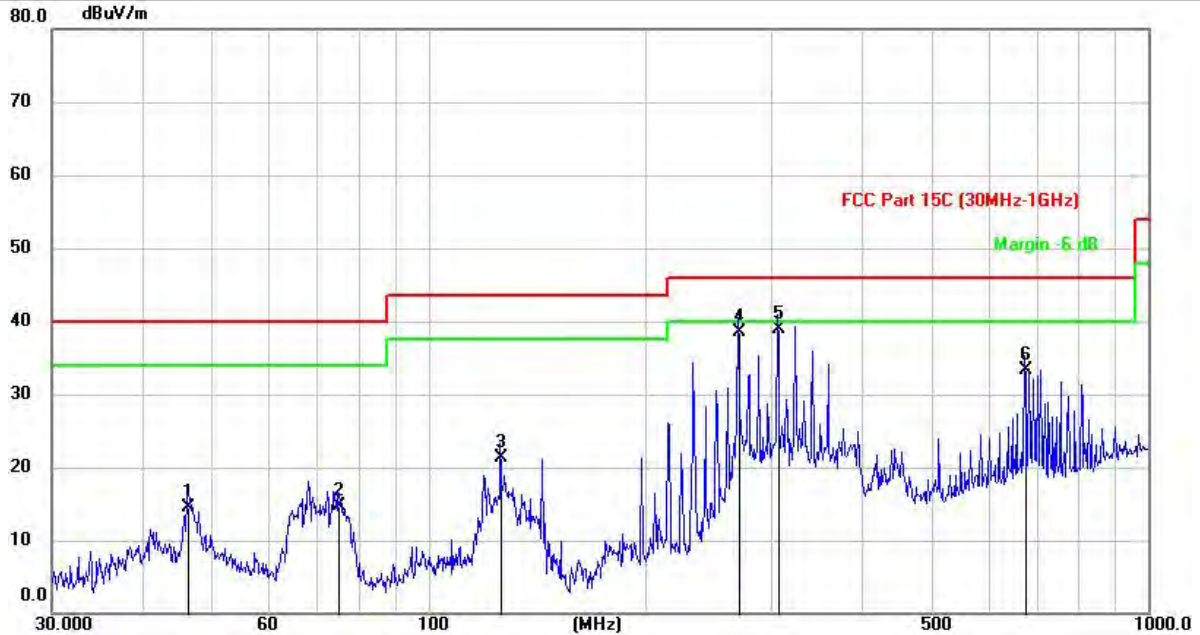

No.	Mk.	Freq. MHz	Reading Level (dBuV)	Correct Factor (dB/m)	Measure- ment (dBuV/m)	Limit (dBuV/m)	Over (dB)	Detector
1		46.3727	30.42	-15.95	14.47	40.00	-25.53	QP
2		75.0769	34.99	-20.22	14.77	40.00	-25.23	QP
3		125.9747	41.57	-20.30	21.27	43.50	-22.23	QP
4		269.9958	53.92	-15.36	38.56	46.00	-7.44	QP
5	*	306.0017	53.34	-14.41	38.93	46.00	-7.07	QP
6		674.9712	40.57	-7.26	33.31	46.00	-12.69	QP

Emission Level= Read Level+ Correct Factor
 Correct Factor=Antenna Factor + Cable Loss -Preamplifier Factor

Test voltage:	DC 3.7V
Ant. Pol.:	Vertical
Test Mode:	TX BLE Mode 2402MHz

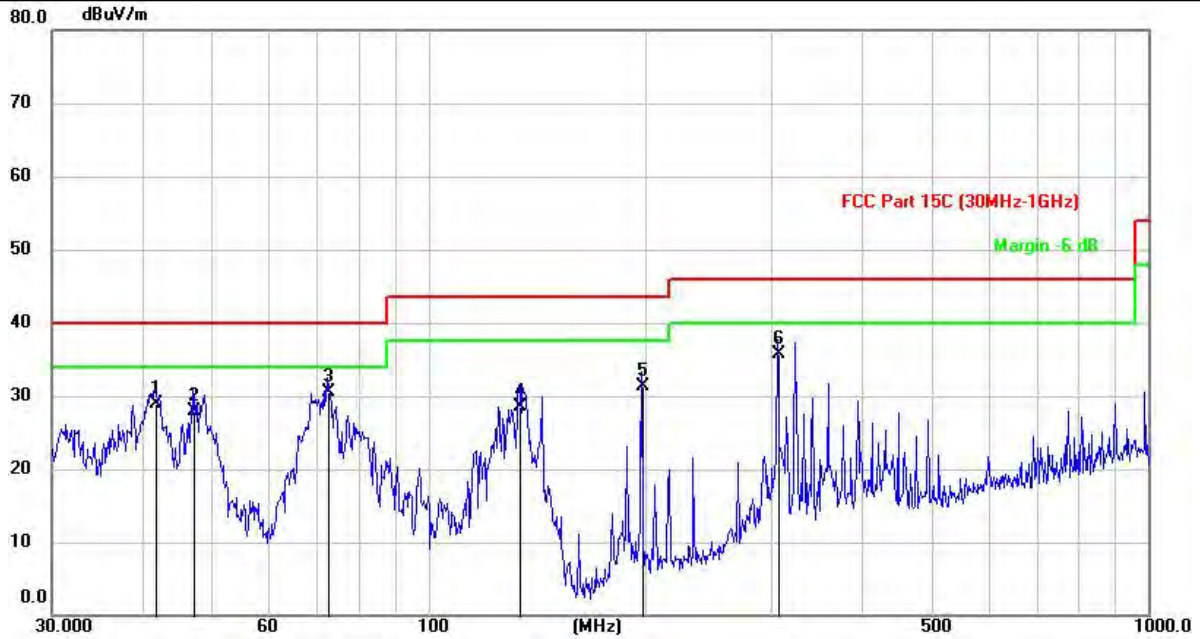

No.	Mk.	Freq. MHz	Reading Level (dBuV)	Correct Factor (dB/m)	Measure- ment (dBuV/m)	Limit (dBuV/m)	Over (dB)	Detector
1		41.8009	45.58	-16.74	28.84	40.00	-11.16	QP
2		47.2095	43.71	-15.88	27.83	40.00	-12.17	QP
3	*	72.4899	50.44	-19.96	30.48	40.00	-9.52	QP
4		134.0412	49.75	-21.31	28.44	43.50	-15.06	QP
5		197.9622	49.44	-18.09	31.35	43.50	-12.15	QP
6		306.0017	50.18	-14.41	35.77	46.00	-10.23	QP

Emission Level= Read Level+ Correct Factor
 Correct Factor=Antenna Factor + Cable Loss -Pre-amplifier Factor

Above 1GHz

Test voltage:	DC 3.7V
Ant. Pol.:	Horizontal
Test Mode:	TX BLE Mode 2402MHz

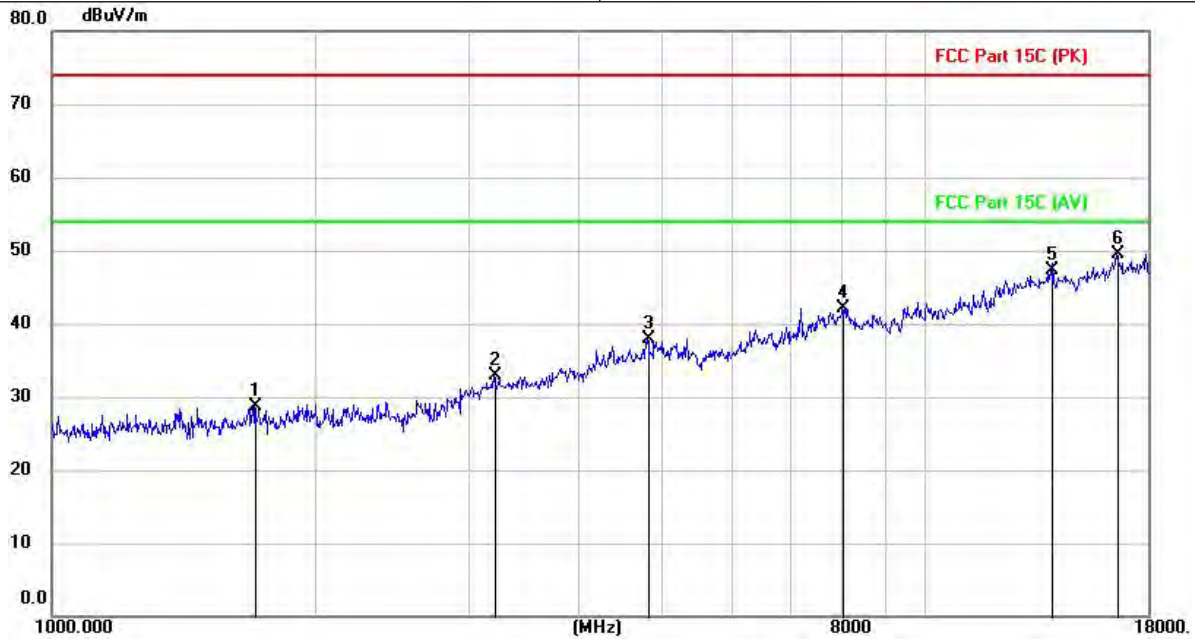

No.	Mk.	Freq. MHz	Reading Level (dBuV)	Correct Factor (dB/m)	Measure- ment (dBuV/m)	Limit (dBuV/m)	Over (dB)	Detector
1		1710.600	40.17	-11.40	28.77	74.00	-45.23	peak
2		3211.700	43.07	-10.20	32.87	74.00	-41.13	peak
3		4804.600	43.81	-5.92	37.89	74.00	-36.11	peak
4		8049.900	40.10	2.06	42.16	74.00	-31.84	peak
5		13952.300	36.11	11.17	47.28	74.00	-26.72	peak
6	*	16582.200	35.75	13.68	49.43	74.00	-24.57	peak

Emission Level= Read Level+ Correct Factor
 Correct Factor=Antenna Factor + Cable Loss -Preamplifier Factor

Test voltage:	DC 3.7V
Ant. Pol.:	Vertical
Test Mode:	TX BLE Mode 2402MHz

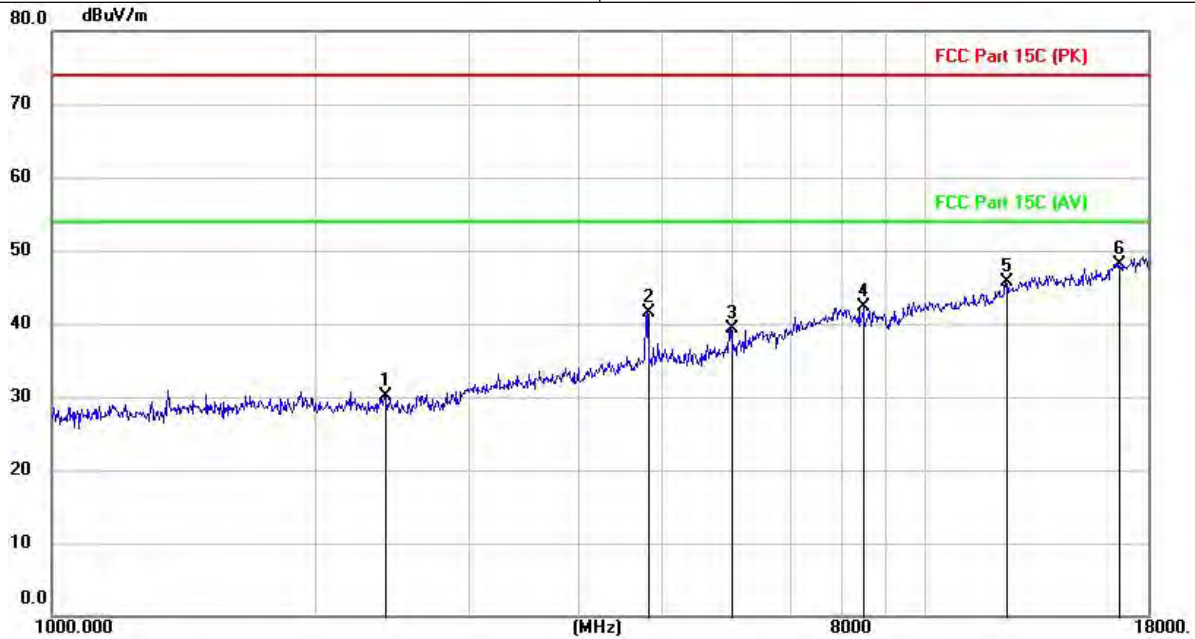

No. Mk.	Freq. MHz	Reading Level (dBuV)	Correct Factor (dB/m)	Measure- ment (dBuV/m)	Limit (dBuV/m)	Over (dB)	Detector
1	2404.200	41.12	-10.92	30.20	74.00	-43.80	peak
2	4804.600	47.43	-5.92	41.51	74.00	-32.49	peak
3	5984.400	43.20	-3.84	39.36	74.00	-34.64	peak
4	8498.700	40.28	1.94	42.22	74.00	-31.78	peak
5	12386.600	37.07	8.72	45.79	74.00	-28.21	peak
6 *	16667.200	34.64	13.55	48.19	74.00	-25.81	peak

Emission Level= Read Level+ Correct Factor
 Correct Factor=Antenna Factor + Cable Loss -Preamplifier Factor

Test voltage:	DC 3.7V
Ant. Pol.:	Horizontal
Test Mode:	TX BLE Mode 2440MHz

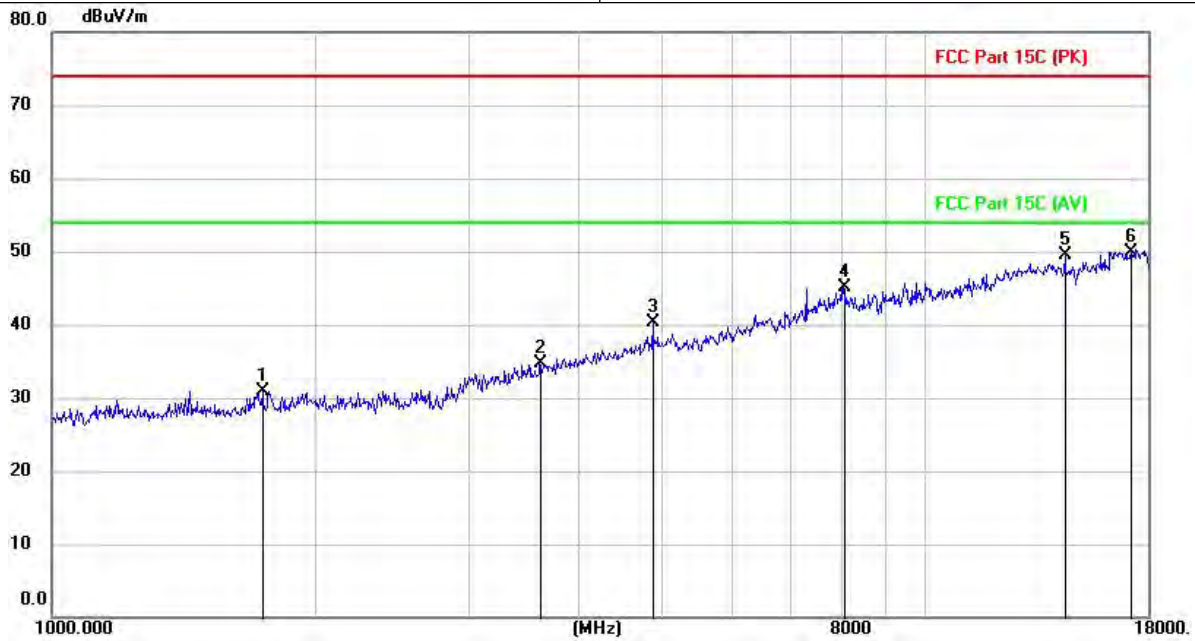

No. Mk.	Freq. MHz	Reading Level (dBuV)	Correct Factor (dB/m)	Measure- ment (dBuV/m)	Limit (dBuV/m)	Over (dB)	Detector
1	1742.900	42.21	-11.33	30.88	74.00	-43.12	peak
2	3626.500	44.03	-9.37	34.66	74.00	-39.34	peak
3	4879.400	45.93	-5.72	40.21	74.00	-33.79	peak
4	8066.900	43.07	2.05	45.12	74.00	-28.88	peak
5	14487.800	38.88	10.59	49.47	74.00	-24.53	peak
6 *	17235.000	36.78	13.21	49.99	74.00	-24.01	peak

Emission Level= Read Level+ Correct Factor
 Correct Factor=Antenna Factor + Cable Loss -Preamplifier Factor

Test voltage:	DC 3.7V
Ant. Pol.:	Vertical
Test Mode:	TX BLE Mode 2440MHz

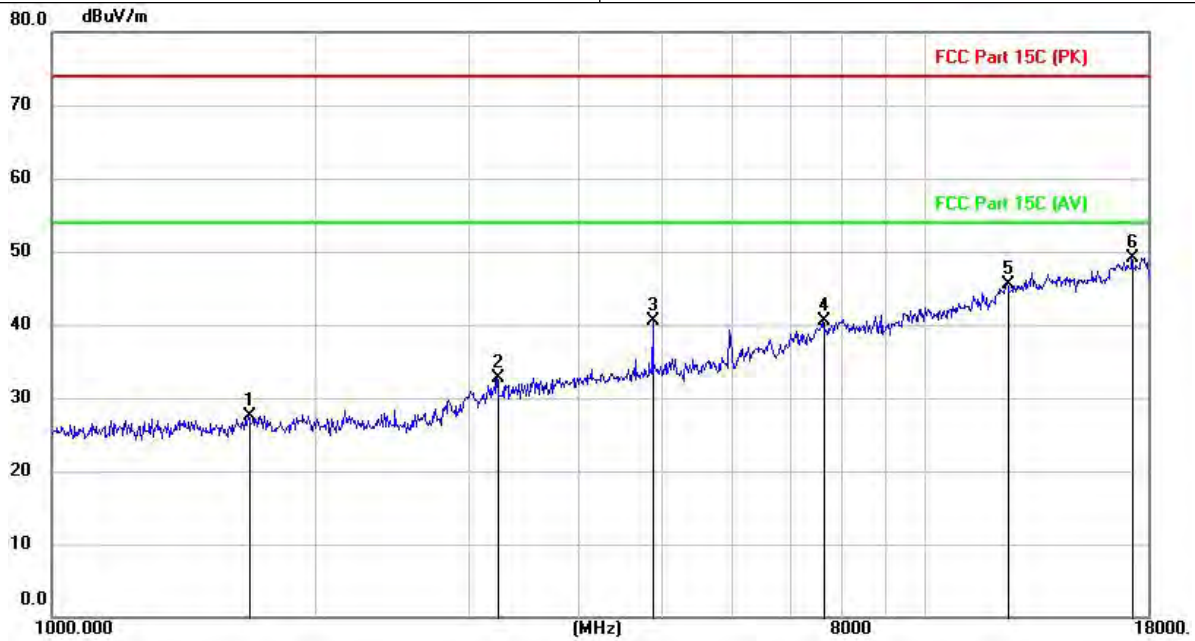

No.	Mk.	Freq. MHz	Reading Level (dBuV)	Correct Factor (dB/m)	Measure- ment (dBuV/m)	Limit (dBuV/m)	Over (dB)	Detector
1		1678.300	39.05	-11.46	27.59	74.00	-46.41	peak
2		3235.500	42.84	-10.16	32.68	74.00	-41.32	peak
3		4879.400	46.15	-5.72	40.43	74.00	-33.57	peak
4		7635.100	39.27	1.15	40.42	74.00	-33.58	peak
5		12427.400	36.65	8.81	45.46	74.00	-28.54	peak
6	*	17262.200	35.91	13.22	49.13	74.00	-24.87	peak

Emission Level= Read Level+ Correct Factor
 Correct Factor=Antenna Factor + Cable Loss -Preamplifier Factor

Test voltage:	DC 3.7V
Ant. Pol.:	Horizontal
Test Mode:	TX BLE Mode 2480MHz

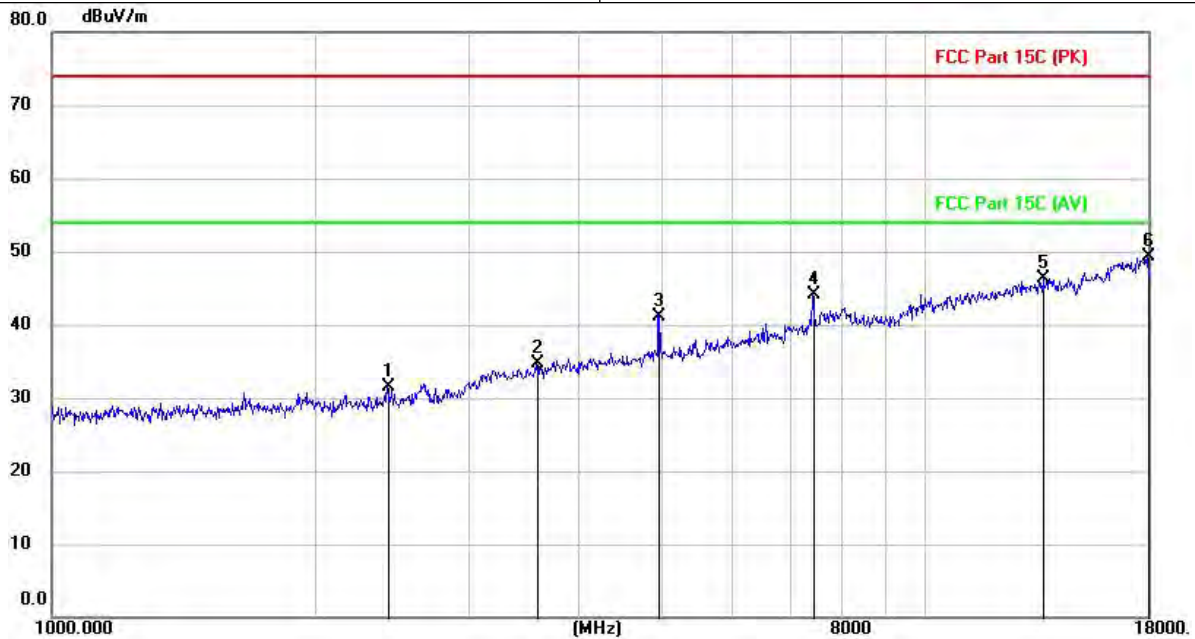

No.	Mk.	Freq. MHz	Reading Level (dBuV)	Correct Factor (dB/m)	Measure- ment (dBuV/m)	Limit (dBuV/m)	Over (dB)	Detector
1		2424.600	42.45	-10.90	31.55	74.00	-42.45	peak
2		3590.800	44.14	-9.45	34.69	74.00	-39.31	peak
3		4959.300	46.68	-5.51	41.17	74.00	-32.83	peak
4		7439.600	43.44	0.64	44.08	74.00	-29.92	peak
5		13671.800	35.53	10.82	46.35	74.00	-27.65	peak
6	*	17989.800	35.70	13.61	49.31	74.00	-24.69	peak

Emission Level= Read Level+ Correct Factor
 Correct Factor=Antenna Factor + Cable Loss -Preamplifier Factor

Test voltage:	DC 3.7V
Ant. Pol.:	Vertical
Test Mode:	TX BLE Mode 2480MHz

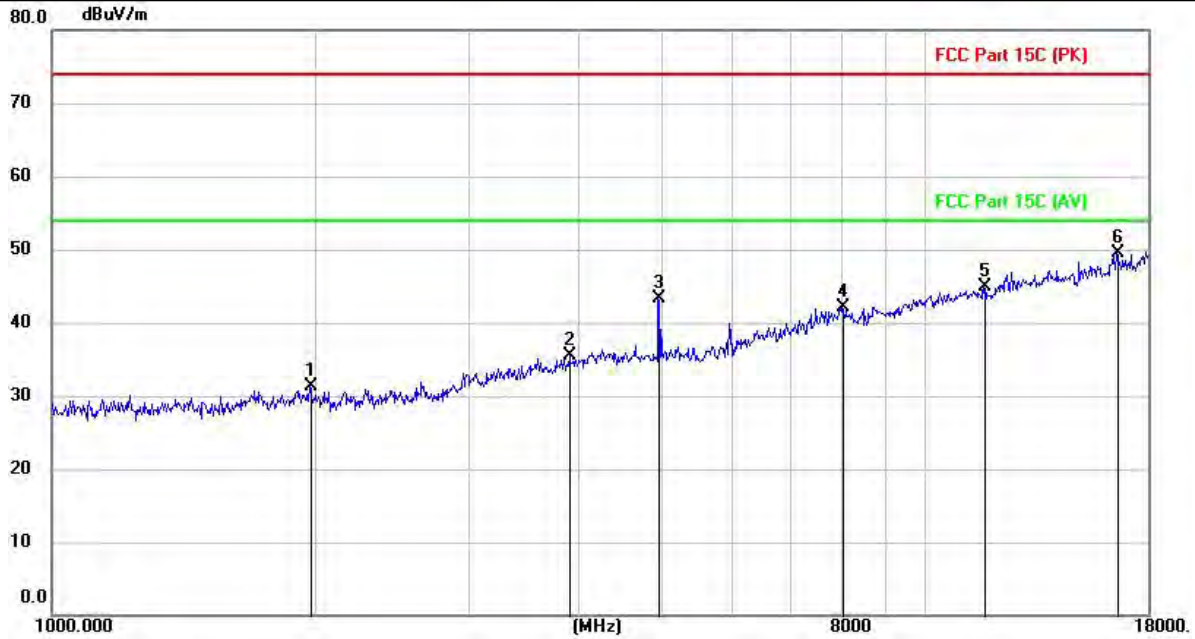

No.	Mk.	Freq.	Reading Level	Correct Factor	Measurement	Limit	Over	Detector
		MHz	(dBuV)	(dB/m)	(dBuV/m)	(dBuV/m)	(dB)	
1		1972.400	42.49	-11.09	31.40	74.00	-42.60	peak
2		3920.600	44.09	-8.63	35.46	74.00	-38.54	peak
3		4959.300	48.80	-5.51	43.29	74.00	-30.71	peak
4		8051.600	39.96	2.05	42.01	74.00	-31.99	peak
5		11679.400	37.72	7.23	44.95	74.00	-29.05	peak
6	*	16566.900	35.81	13.71	49.52	74.00	-24.48	peak

Emission Level= Read Level+ Correct Factor
 Correct Factor=Antenna Factor + Cable Loss -Preamplifier Factor

Note:

From 18GHz to 26.5GHz, the amplitude of spurious emissions which are attenuated by more than 20dB below the permissible value has no need to be reported.

TRF No. FCC Part 15.247_R1

Add : West Side of 1/F., Building C, Zone A, Fuyuan New Factory, Jiujiu Industrial Park, Minzhu, Shatou, Shajing, Bao'an District, Shenzhen, Guangdong, China

Tel : +(86) 0755-2985 2678 Fax: +(86) 0755-2985 2397 E-mail : info@gdksign.cn Web: www.gdksign.com

3.4. Band Edge Emissions(Radiated)

Limit

Restricted Frequency Band (MHz)	(dBuV/m)(at 3m)	
	Peak	Average
2310 ~2390	74	54
2483.5 ~2500	74	54

Note: All restriction bands have been tested, only the worst case is reported.

Test Configuration

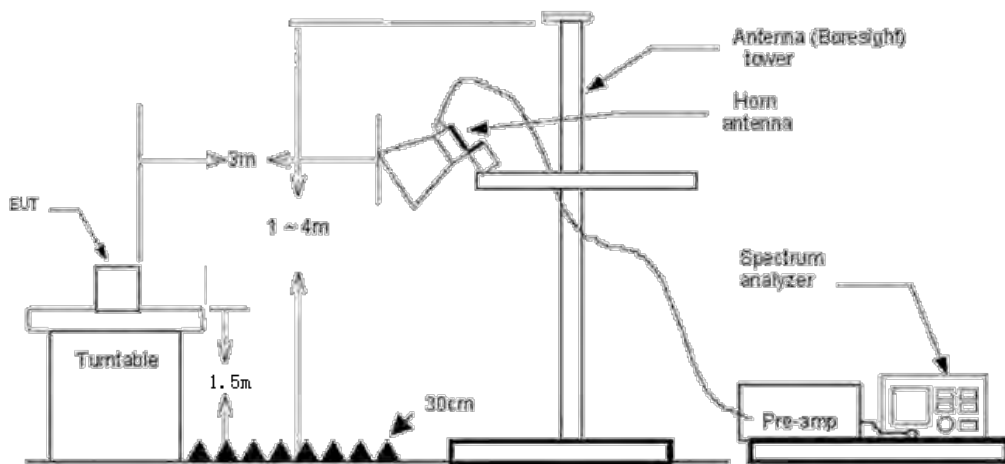

Test Procedure

1. The EUT was setup and tested according to ANSI C63.10:2020 requirements.
2. The EUT is placed on a turn table which is 1.5 meter above ground. The turn table is rotated 360 degrees to determine the position of the maximum emission level.
3. The EUT was positioned such that the distance from antenna to the EUT was 3 meters.
4. The antenna is scanned from 1 meter to 4 meters to find out the maximum emission level. This is repeated for both horizontal and vertical polarization of the antenna. In order to find the maximum emission, all of the interface cables were manipulated according to ANSI C63.10:2020 on radiated measurement.
5. The receiver set as follow:
 RBW=1MHz, VBW=3MHz Peak detector for Peak value.
 RBW=1MHz, VBW=10Hz with Peak detector for Average value.

Test Mode

Please refer to the clause 2.2.

Test Results

Note:

1. Measurement = Reading level + Correct Factor
2. Correct Factor=Antenna Factor + Cable Loss -Preamplifier Factor
3. Both modes of BLE 1Mbps and 2Mbps were tested at Low and High channel and recorded worst mode at BLE 1Mbps.

TRF No. FCC Part 15.247_R1

Add : West Side of 1/F., Building C, Zone A, Fuyuan New Factory, Jiujiu Industrial Park, Minzhu, Shatou, Shajing, Bao'an District, Shenzhen, Guangdong, China

Tel : +(86) 0755-2985 2678 Fax: +(86) 0755-2985 2397 E-mail : info@gdkesign.cn Web: www.gdkesign.com

Test Voltage	DC 3.7V
Ant. Pol.:	Horizontal
Test Mode:	TX BLE Mode 2402MHz

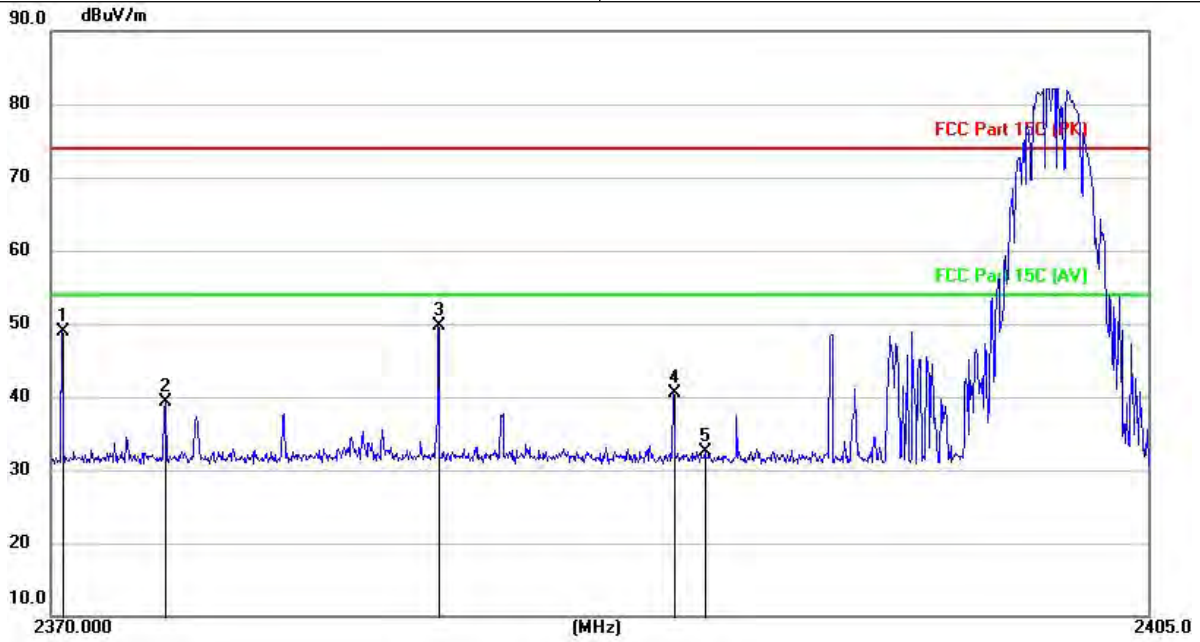

No.	Mk.	Freq. MHz	Reading Level (dBuV)	Correct Factor (dB/m)	Measure- ment (dBuV/m)	Limit (dBuV/m)	Over (dB)	Detector
1		2370.378	59.92	-10.92	49.00	74.00	-25.00	peak
2		2373.630	50.19	-10.93	39.26	74.00	-34.74	peak
3	*	2382.309	60.60	-10.92	49.68	74.00	-24.32	peak
4		2389.803	51.52	-10.92	40.60	74.00	-33.40	peak
5		2390.814	43.51	-10.92	32.59	74.00	-41.41	peak

Emission Level= Read Level+ Correct Factor

Test Voltage	DC 3.7V
Ant. Pol.	Vertical
Test Mode:	TX BLE Mode 2402MHz

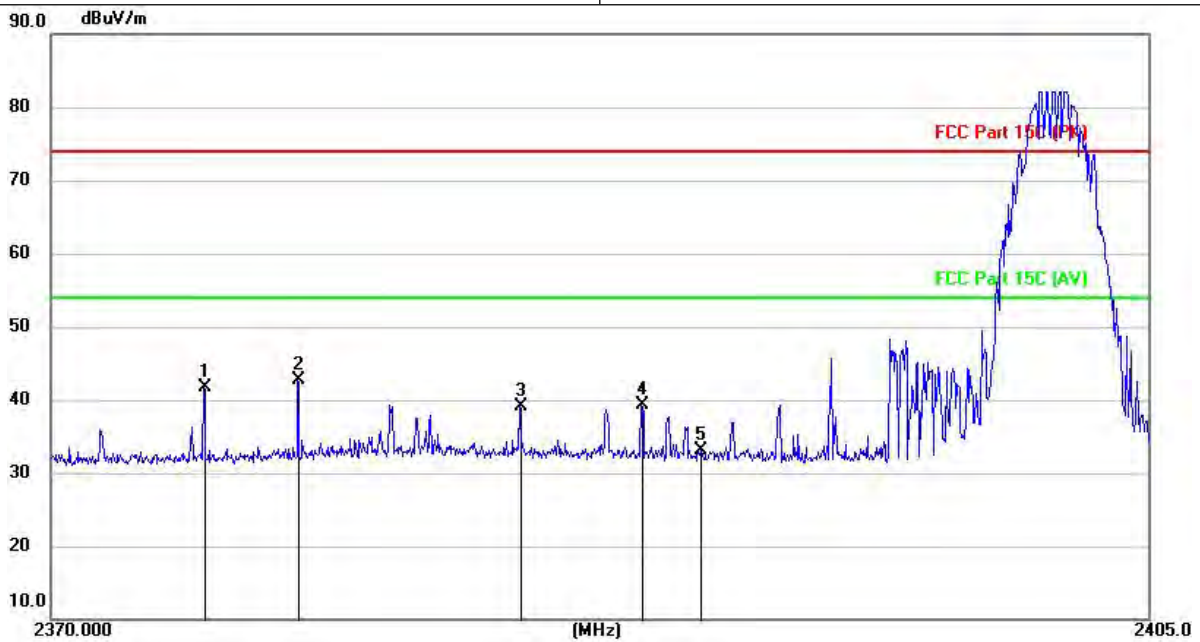

No.	Mk.	Freq. MHz	Reading Level (dBuV)	Correct Factor (dB/m)	Measure- ment (dBuV/m)	Limit (dBuV/m)	Over (dB)	Detector
1		2374.854	52.64	-10.93	41.71	74.00	-32.29	peak
2	*	2377.840	53.73	-10.93	42.80	74.00	-31.20	peak
3		2384.889	50.04	-10.92	39.12	74.00	-34.88	peak
4		2388.788	50.24	-10.93	39.31	74.00	-34.69	peak
5		2390.675	44.11	-10.92	33.19	74.00	-40.81	peak

Emission Level= Read Level+ Correct Factor

Test Voltage	DC 3.7V
Ant. Pol.	Horizontal
Test Mode:	TX BLE Mode 2480 MHz

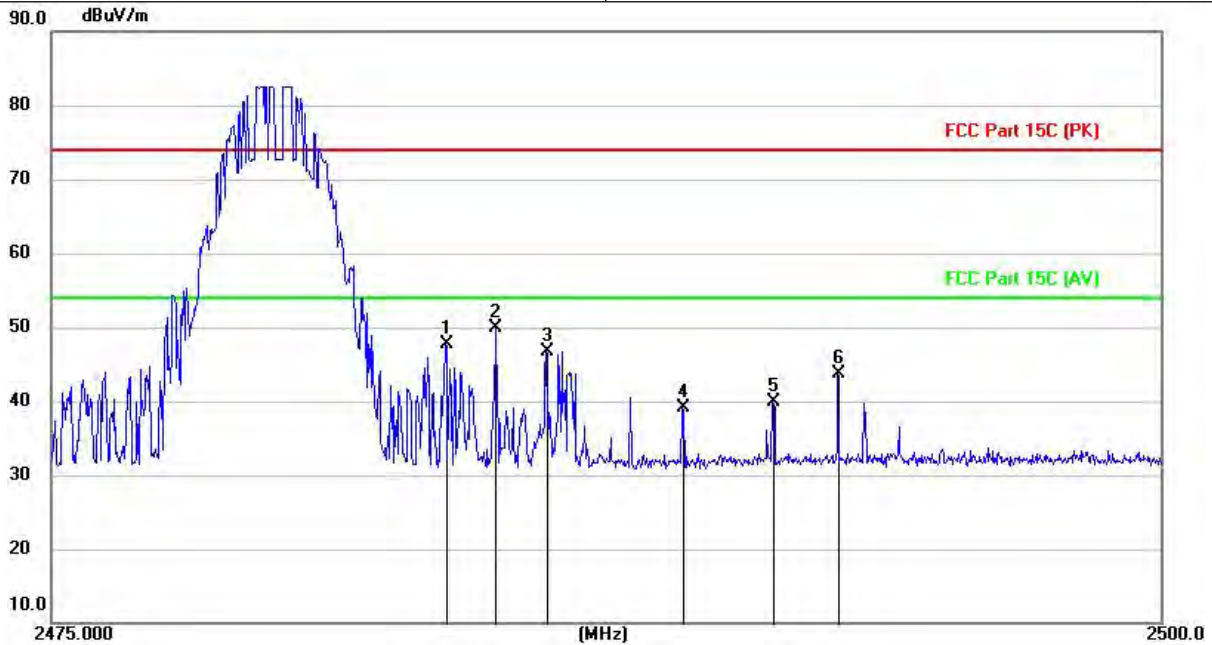

No.	Mk.	Freq. MHz	Reading Level (dBuV)	Correct Factor (dB/m)	Measure- ment (dBuV/m)	Limit (dBuV/m)	Over (dB)	Detector
1		2483.852	58.55	-10.88	47.67	74.00	-26.33	peak
2	*	2484.988	60.84	-10.88	49.96	74.00	-24.04	peak
3		2486.137	57.63	-10.88	46.75	74.00	-27.25	peak
4		2489.207	49.94	-10.89	39.05	74.00	-34.95	peak
5		2491.233	50.89	-10.89	40.00	74.00	-34.00	peak
6		2492.710	54.55	-10.89	43.66	74.00	-30.34	peak

Emission Level= Read Level+ Correct Factor

Test Voltage	DC 3.7V
Ant. Pol.	Vertical
Test Mode:	TX BLE Mode 2480 MHz

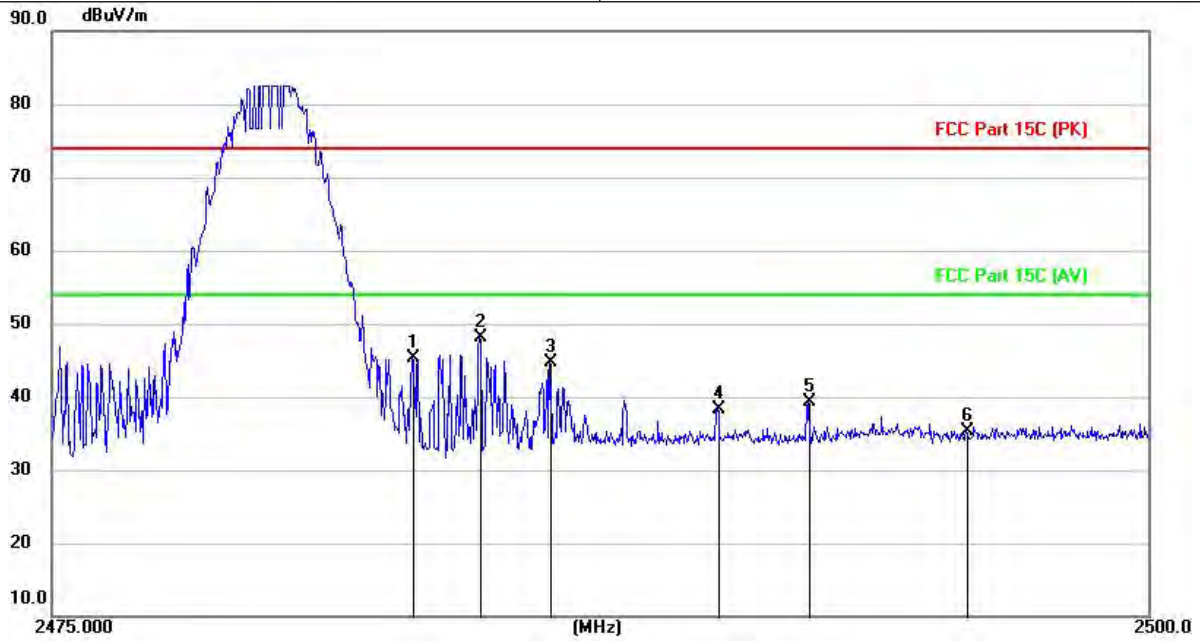

No.	Mk.	Freq. MHz	Reading Level (dBuV)	Correct Factor (dB/m)	Measure- ment (dBuV/m)	Limit (dBuV/m)	Over (dB)	Detector
1		2483.200	56.25	-10.88	45.37	74.00	-28.63	peak
2	*	2484.730	58.90	-10.88	48.02	74.00	-25.98	peak
3		2486.343	55.52	-10.88	44.64	74.00	-29.36	peak
4		2490.160	49.22	-10.89	38.33	74.00	-35.67	peak
5		2492.240	50.21	-10.89	39.32	74.00	-34.68	peak
6		2495.855	46.24	-10.87	35.37	74.00	-38.63	peak

Emission Level= Read Level+ Correct Factor

3.5. Peak Output Power

Limit

Test Item	Limit	Frequency Range(MHz)
Peak Output Power	1 Watt or 30 dBm	2400~2483.5

Test Configuration

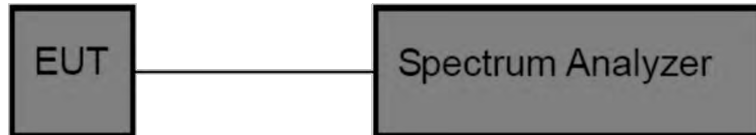

Test Procedure

1. Connect EUT RF Output port to the Spectrum Analyzer through an RF attenuator.
2. Spectrum Setting:
 Peak Detector: $RBW \geq DTS \text{ Bandwidth}$, $VBW \geq 3 * RBW$.
 Sweep time=Auto.
 Detector= Peak.
 Trace mode= Maxhold.
 Allow trace to fully stabilize. Then use the peak marker function to determine the maximum amplitude level.

Test Mode

Please refer to the clause 2.2.

Test Result

Test Channel	Frequency (MHz)	Maximum Conducted Output Power(PK) (dBm)	Limit (dBm)	Result
GFSK 1Mbps	2402	5.68	30	Pass
	2440	5.44	30	Pass
	2480	5.16	30	Pass
GFSK 2Mbps	2402	5.65	30	Pass
	2440	5.48	30	Pass
	2480	5.20	30	Pass

Note: 1.The test results including the cable lose.

GFSK 1Mbps

2402 MHz

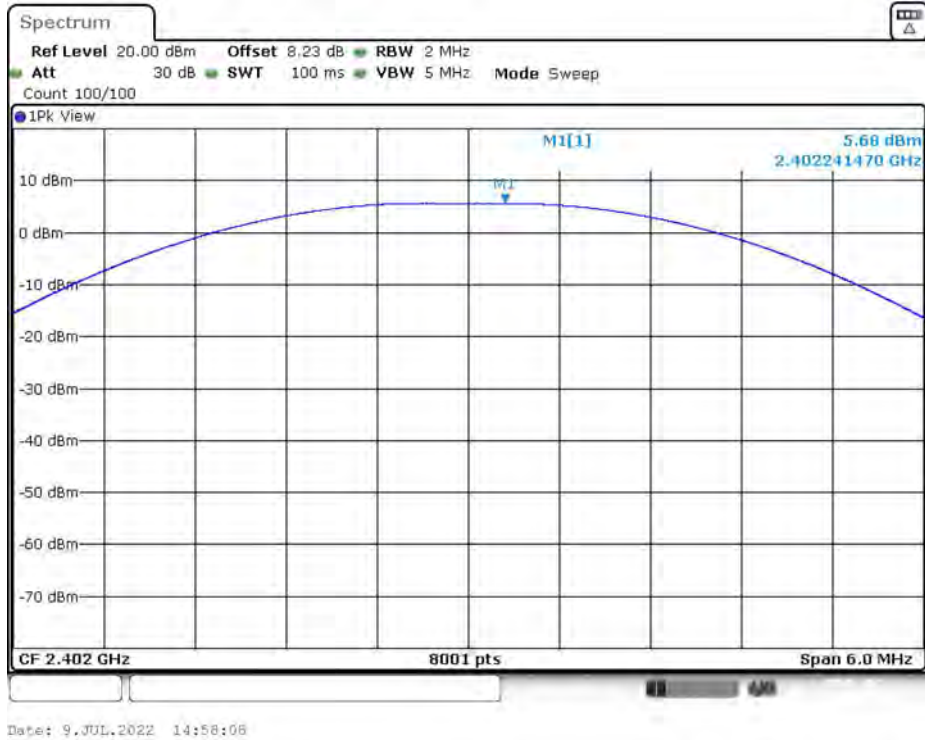

2440 MHz

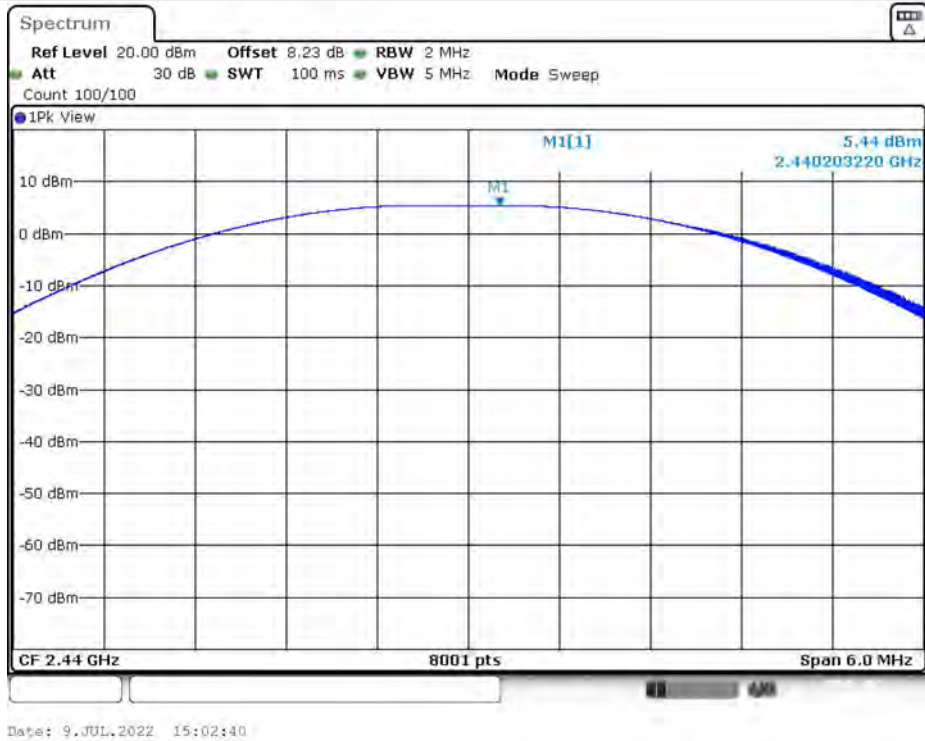

TRF No. FCC Part 15.247_R1

Add : West Side of 1/F., Building C, Zone A, Fuyuan New Factory, Jiujiu Industrial Park, Minzhu, Shatou, Shajing, Bao'an District, Shenzhen, Guangdong, China

Tel : +(86) 0755-2985 2678 Fax: +(86) 0755-2985 2397 E-mail : info@gksign.cn Web: www.gksign.com

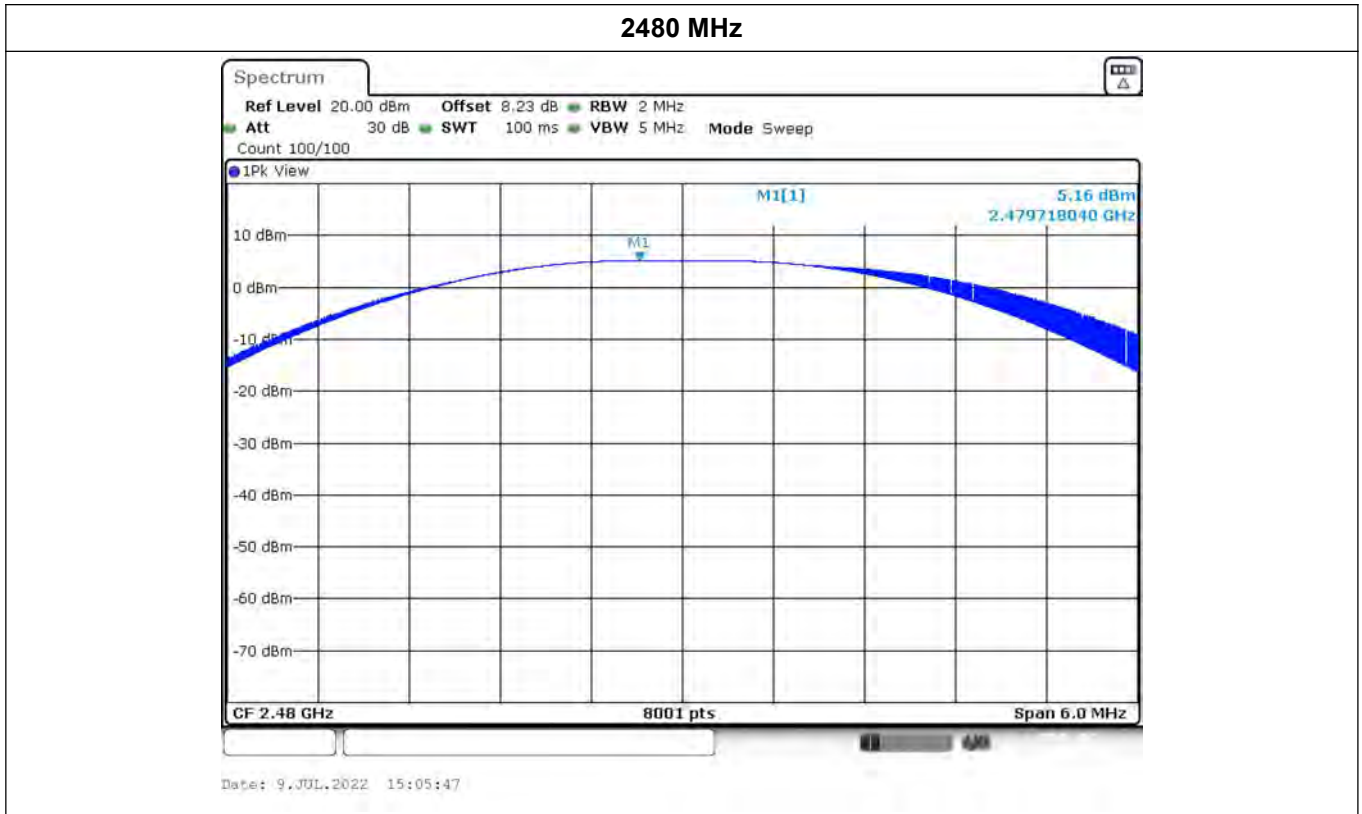

GFSK 2Mbps



TRF No. FCC Part 15.247_R1

Add : West Side of 1/F., Building C, Zone A, Fuyuan New Factory, Jiujiu Industrial Park, Minzhu, Shatou, Shajing, Bao'an District, Shenzhen, Guangdong, China

Tel : +(86) 0755-2985 2678 Fax: +(86) 0755-2985 2397 E-mail : info@gksign.cn Web: www.gksign.com

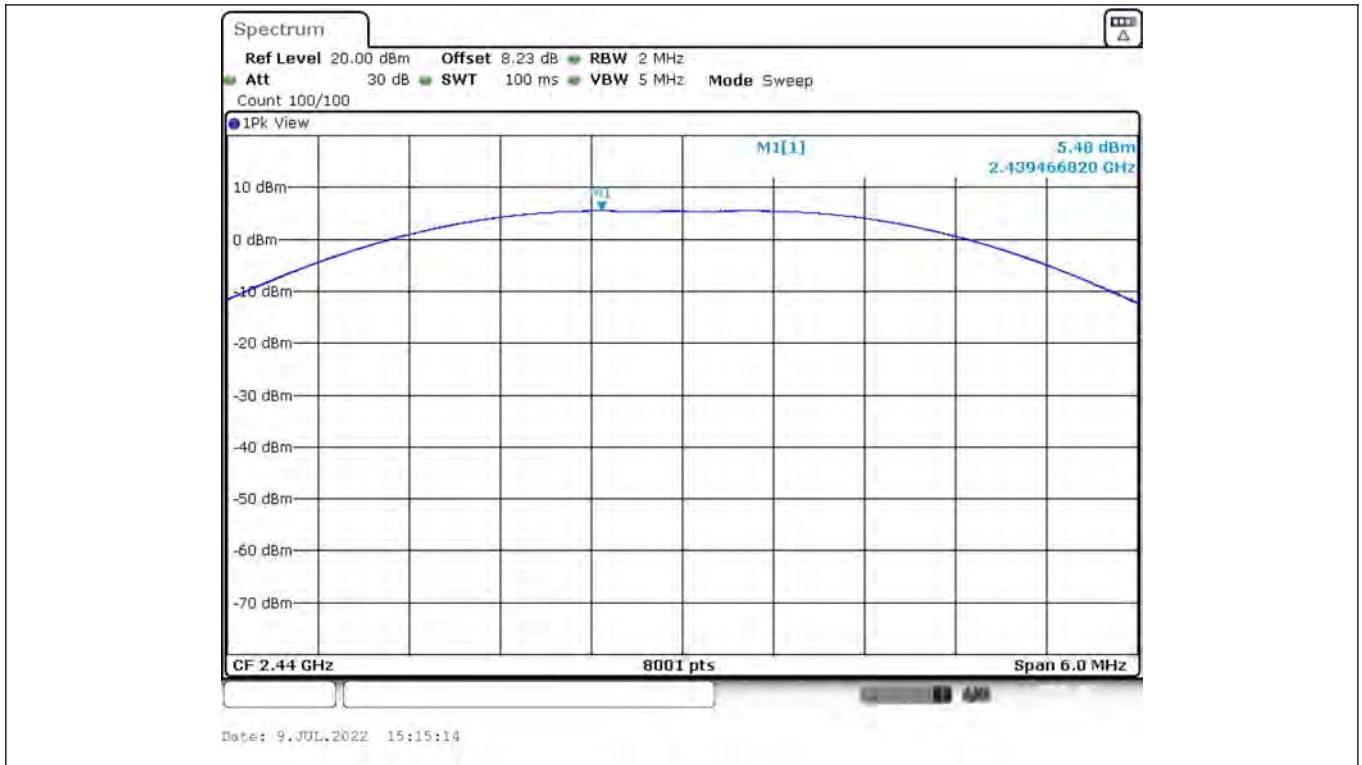

2480 MHz

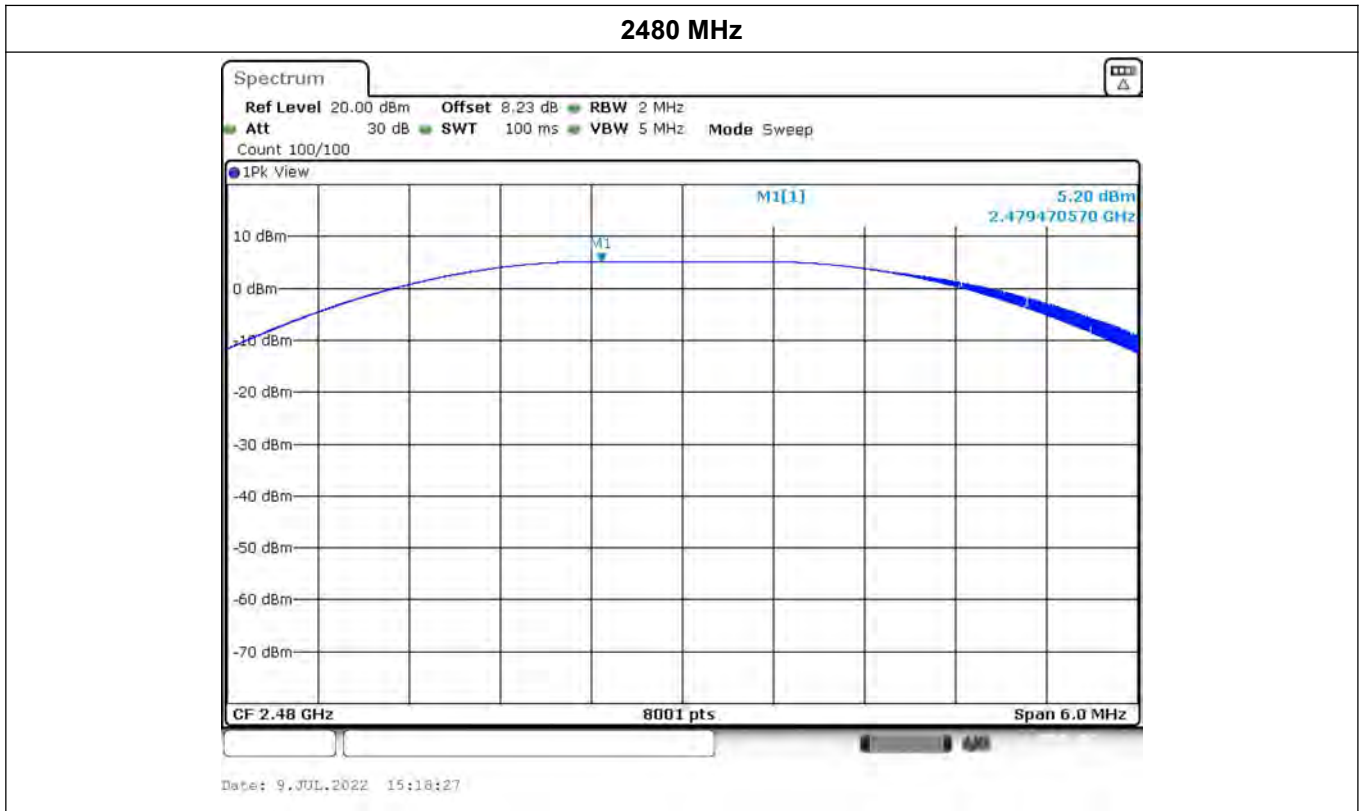

3.6. Power Spectral Density

Limit

FCC Part 15 Subpart C(15.247)		
Test Item	Limit	Frequency Range(MHz)
Power Spectral Density	8dBm(in any 3 kHz)	2400~2483.5

Test Configuration

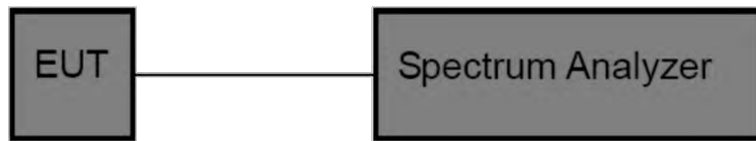

Test Procedure

1. Connect EUT RF Output port to the Spectrum Analyzer through an RF attenuator.
2. The EUT was directly connected to the Spectrum Analyzer and antenna output port as show in the block diagram above. The measurement according to section 10.b-6.ii of KDB 558074 D01 DTS Meas Guidance v05r02.
3. Spectrum Setting:
 - Set analyzer center frequency to DTS channel center frequency.
 - Set the span to 1.5 times the DTS bandwidth.
 - Set the RBW \geq 3 kHz
 - Set the VBW \geq 3 x RBW
 - Detector: peak
 - Sweep time: auto couple
 - Allow trace to fully stabilize.
 - Use the peak marker function to determine the maximum amplitude level.
 - If measured value exceeds limit, reduce RBW (no less than 3 kHz) and repeat.

Test Mode

Please refer to the clause 2.2.

Test Result

Type	Channel	Power Density (dBm/3kHz)	Limit (dBm/3kHz)	Result
GFSK 1Mbps	00	-10.33	8.00	Pass
	19	-10.41		
	39	-10.84		
GFSK 2Mbps	00	-9.95	8.00	Pass
	19	-10.44		
	39	-10.89		

GFSK 1Mbps

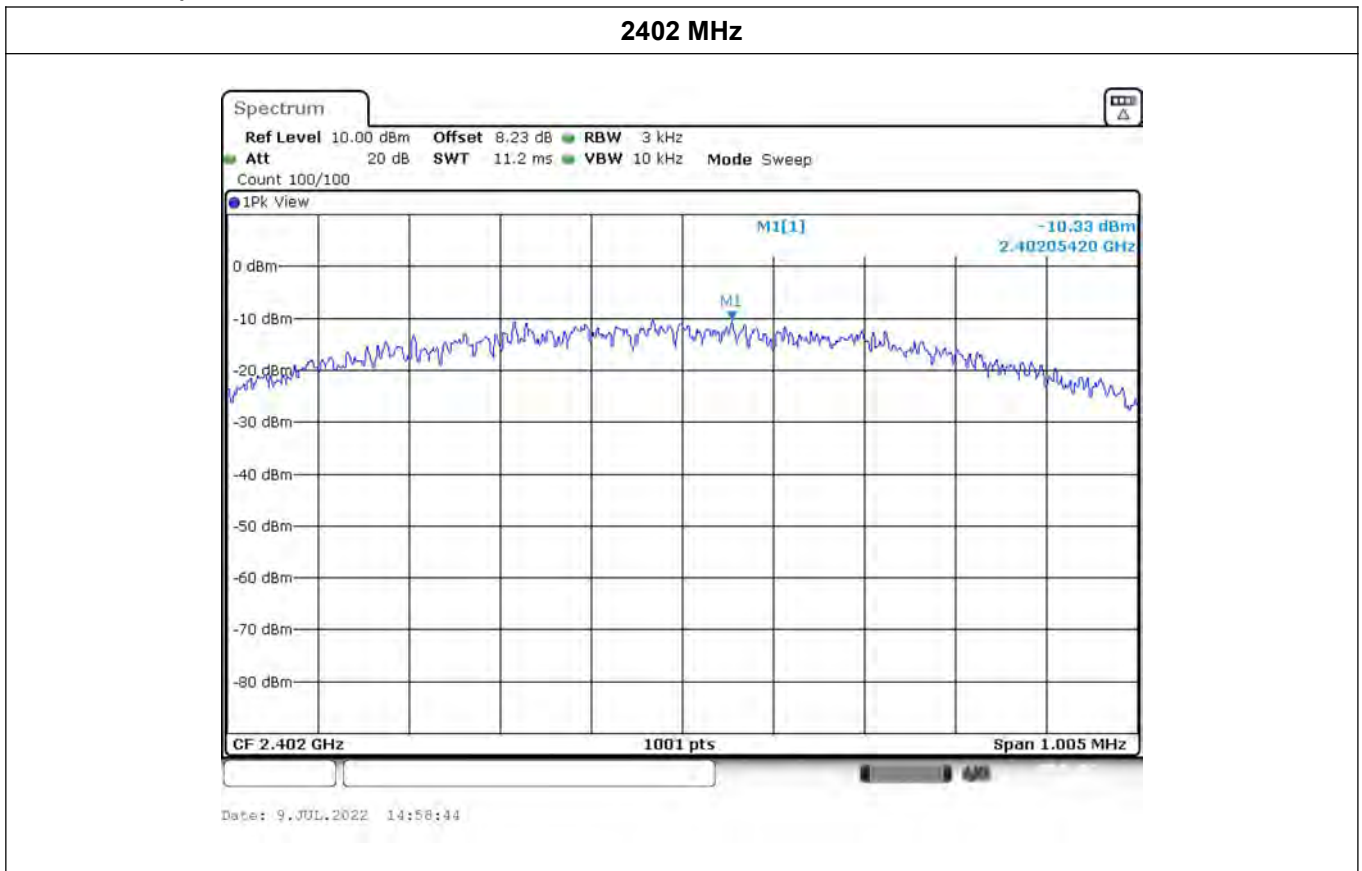

2440 MHz

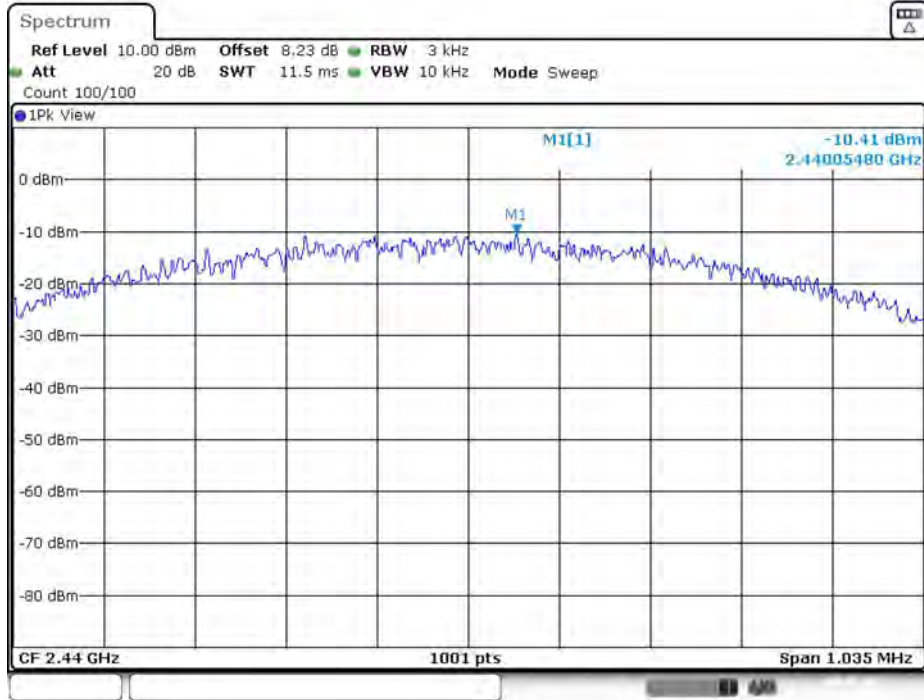

Date: 9.JUL.2022 15:03:16

2480 MHz

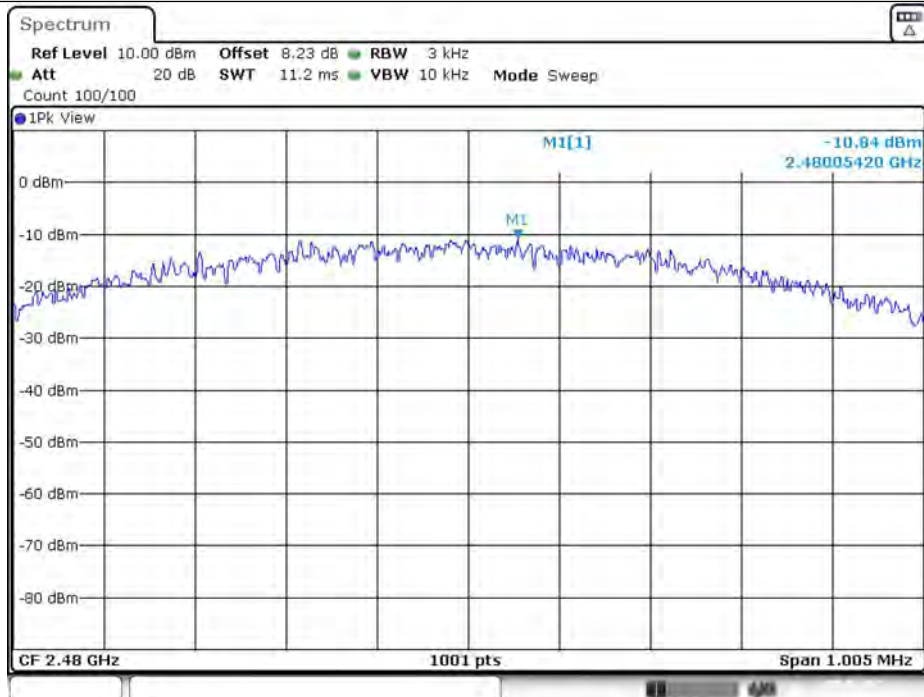

Date: 9.JUL.2022 15:06:25

TRF No. FCC Part 15.247_R1

Add : West Side of 1/F., Building C, Zone A, Fuyuan New Factory, Jiujiu Industrial Park, Minzhu, Shatou, Shajing, Bao'an District, Shenzhen, Guangdong, China

Tel : +(86) 0755-2985 2678 Fax: +(86) 0755-2985 2397 E-mail : info@gksign.cn Web: www.gksign.com

GFSK 2Mbps

2402 MHz

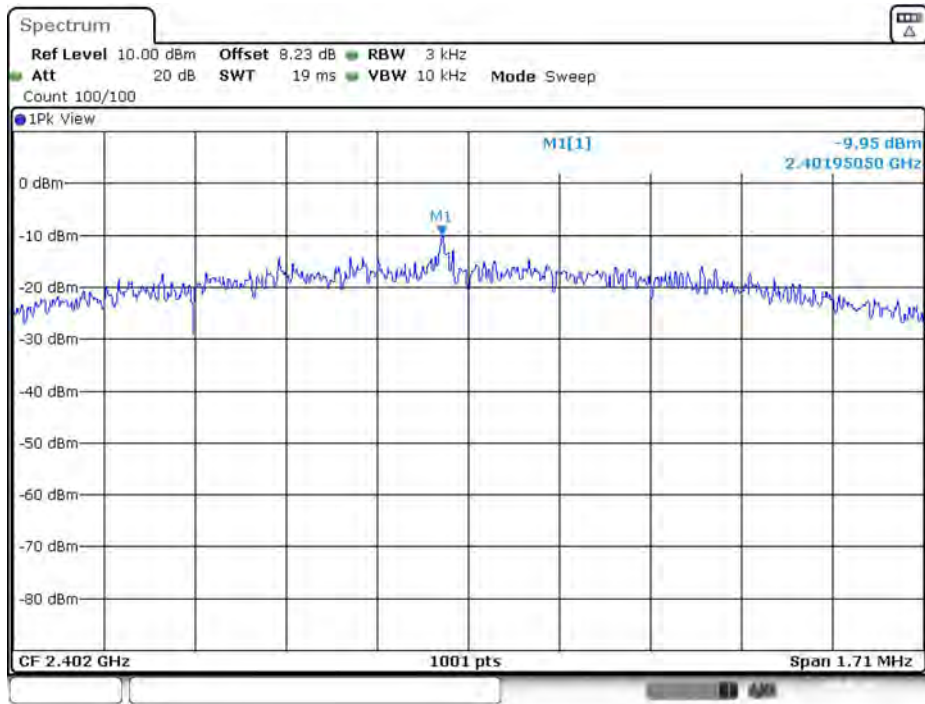

Date: 9.JUL.2022 15:11:00

2440 MHz

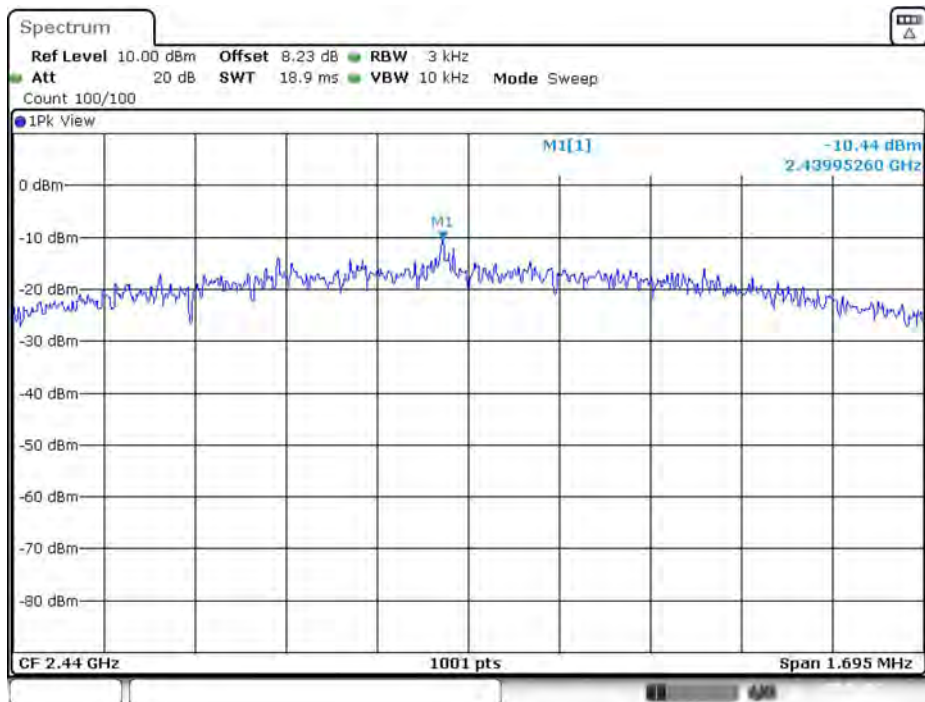

Date: 9.JUL.2022 15:15:53

TRF No. FCC Part 15.247_R1

Add : West Side of 1/F., Building C, Zone A, Fuyuan New Factory, Jiujiu Industrial Park, Minzhu, Shatou, Shajing, Bao'an District, Shenzhen, Guangdong, China

Tel : +(86) 0755-2985 2678 Fax: +(86) 0755-2985 2397 E-mail : info@gksign.cn Web: www.gksign.com

2480 MHz

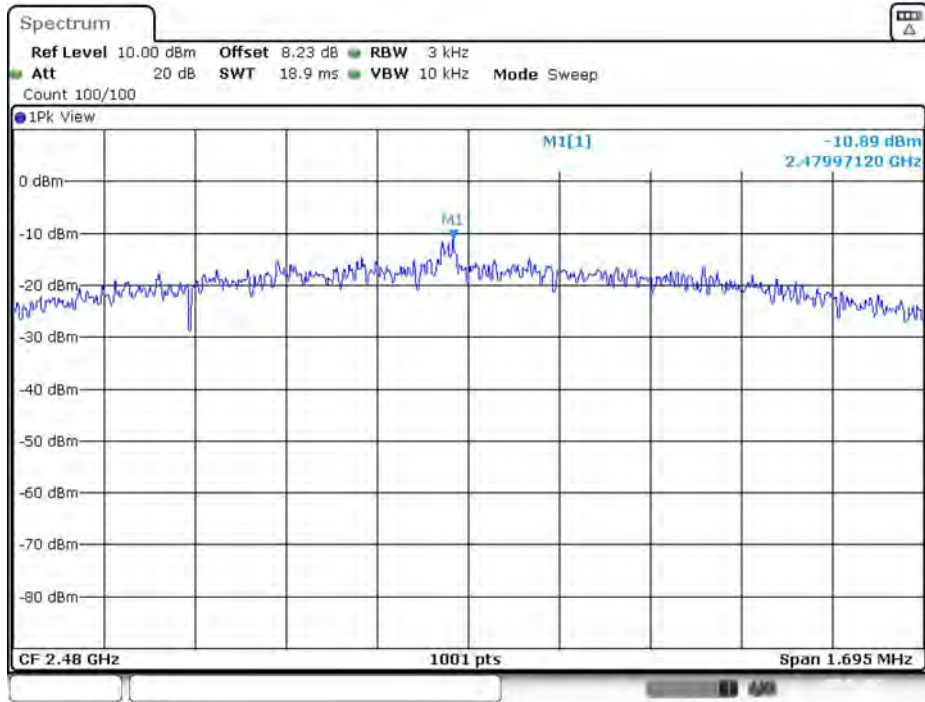

Date: 9 JUL 2022 15:19:04

TRF No. FCC Part 15.247_R1

Add : West Side of 1/F., Building C, Zone A, Fuyuan New Factory, Jiujiu Industrial Park, Minzhu, Shatou, Shajing, Bao'an District, Shenzhen, Guangdong, China

Tel : +(86) 0755-2985 2678 Fax: +(86) 0755-2985 2397 E-mail : info@gdkesign.cn Web: www.gdkesign.com

3.7. 6dB Bandwidth

Limit

Test Item	Limit	Frequency Range(MHz)
Bandwidth	>=500 KHz (6dB bandwidth)	2400~2483.5

Test Configuration

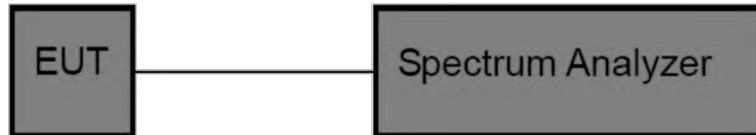

Test Procedure

1. Connect EUT RF Output port to the Spectrum Analyzer through an RF attenuator.
2. The 6dB bandwidth is defined as the total spectrum the power of which is higher than peak power minus 6dB.
3. The occupied bandwidth is the frequency bandwidth such that, below its lower and above its upper frequency limits, the mean powers are each equal to 0.5% of the total mean power of the given emission.
4. Spectrum Setting:
 - 6dB bandwidth:
 - (1) Set RBW = 100 kHz.
 - (2) Set the video bandwidth (VBW) ≥ 3 RBW.
 - (3) Detector = Peak.
 - (4) Trace mode = Max hold.
 - (5) Sweep = Auto couple.
 - (6) Allow the trace to stabilize.
 - (7) Measure the maximum width of the emission that is constrained by the frequencies associated with the two outermost amplitude points (upper and lower frequencies) that are attenuated by 6 dB relative to the maximum level measured in the fundamental emission.

Test Mode

Please refer to the clause 2.2.

Test Results

Type	Channel	6dB bandwidth (MHz)	Limit (MHz)	Result
GFSK 1Mbps	00	0.668	≥0.5	Pass
	19	0.688		
	39	0.672		
GFSK 2Mbps	00	1.140	≥0.5	Pass
	19	1.132		
	39	1.132		

GFSK 1Mbps

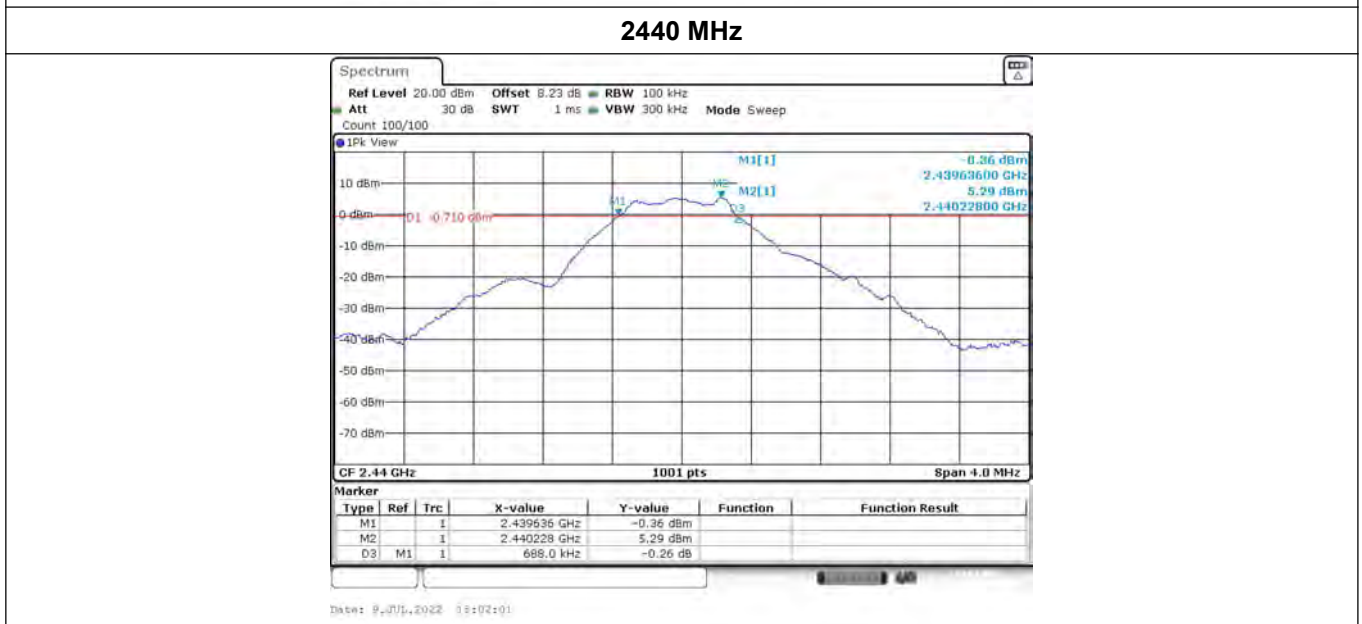
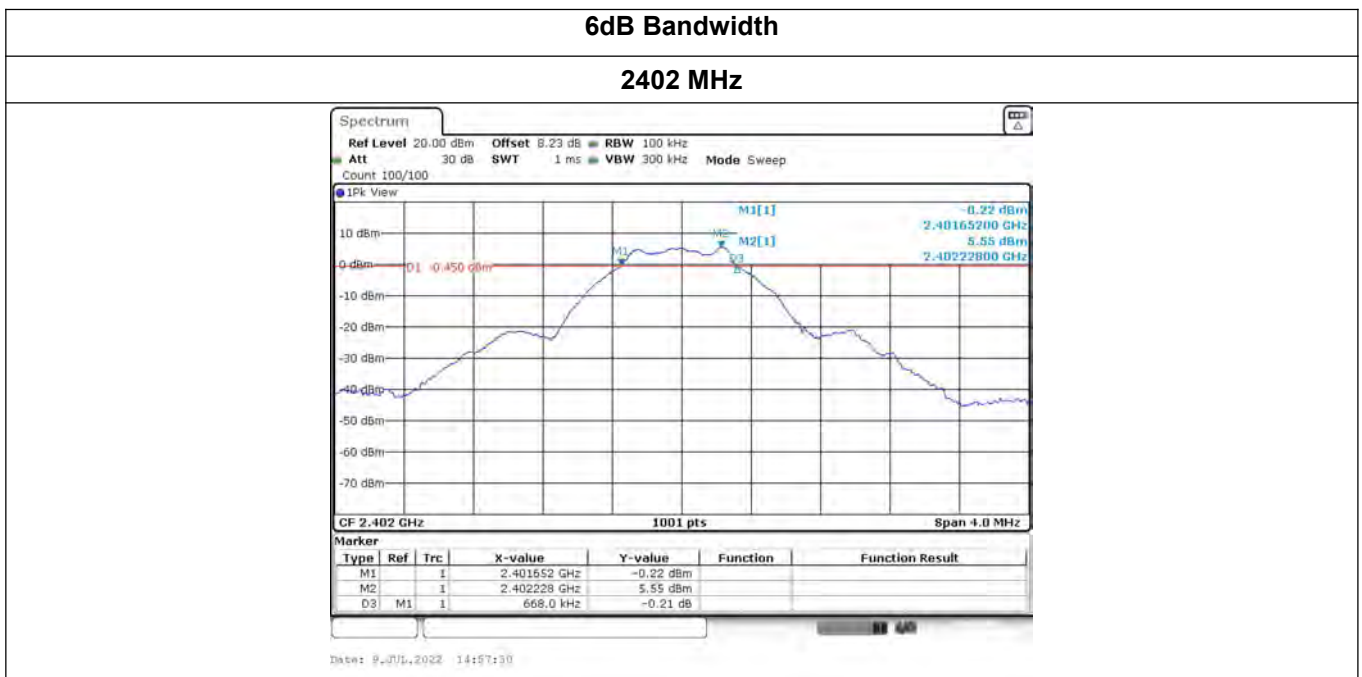

TRF No. FCC Part 15.247_R1

Add : West Side of 1/F., Building C, Zone A, Fuyuan New Factory, Jiujiu Industrial Park, Minzhu, Shatou, Shajing, Bao'an District, Shenzhen, Guangdong, China

Tel : +(86) 0755-2985 2678 Fax: +(86) 0755-2985 2397 E-mail : info@gdksign.cn Web: www.gdksign.com

2480 MHz

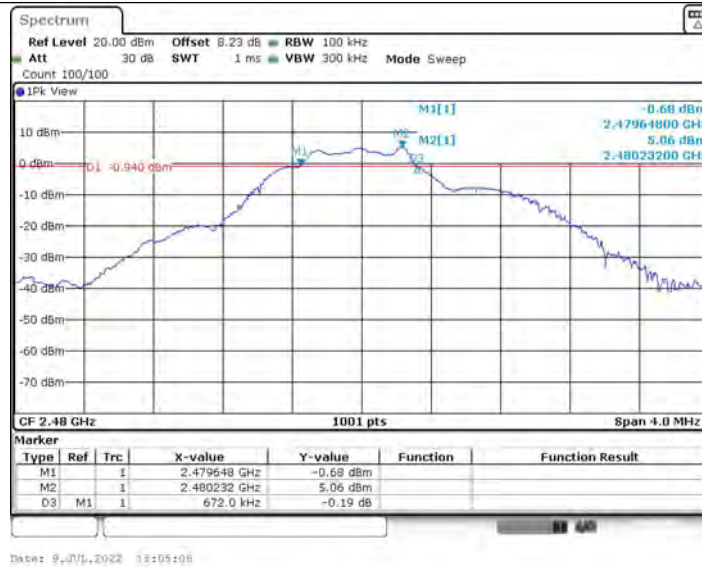

GFSK 2Mbps

6dB Bandwidth

2402 MHz

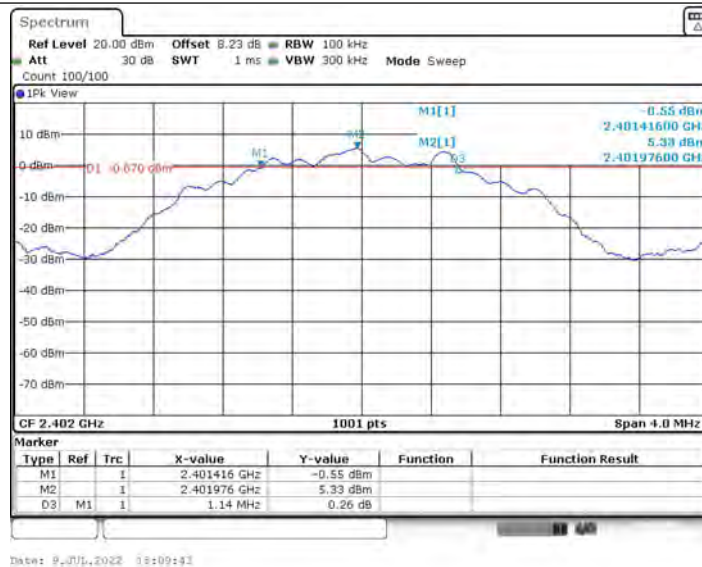

2440 MHz

TRF No. FCC Part 15.247_R1

Add : West Side of 1/F., Building C, Zone A, Fuyuan New Factory, Jiujiu Industrial Park, Minzhu, Shatou, Shajing, Bao'an District, Shenzhen, Guangdong, China

Tel : +(86) 0755-2985 2678 Fax: +(86) 0755-2985 2397 E-mail : info@gksign.cn Web: www.gksign.com

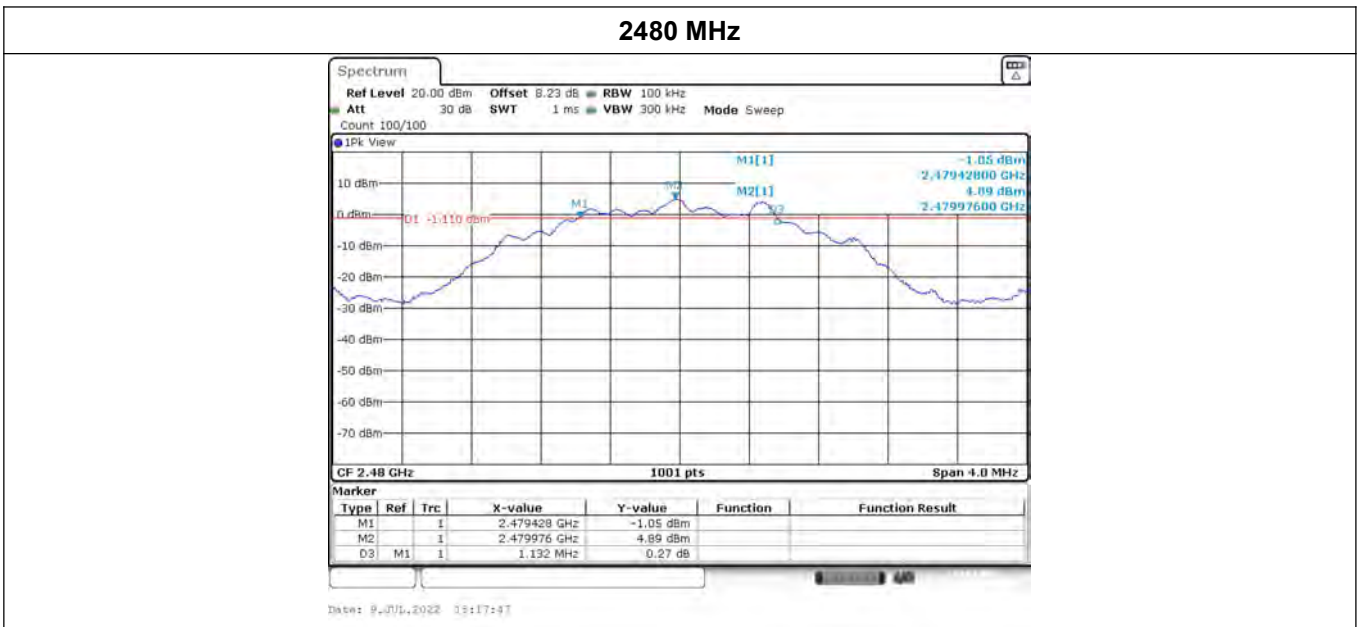
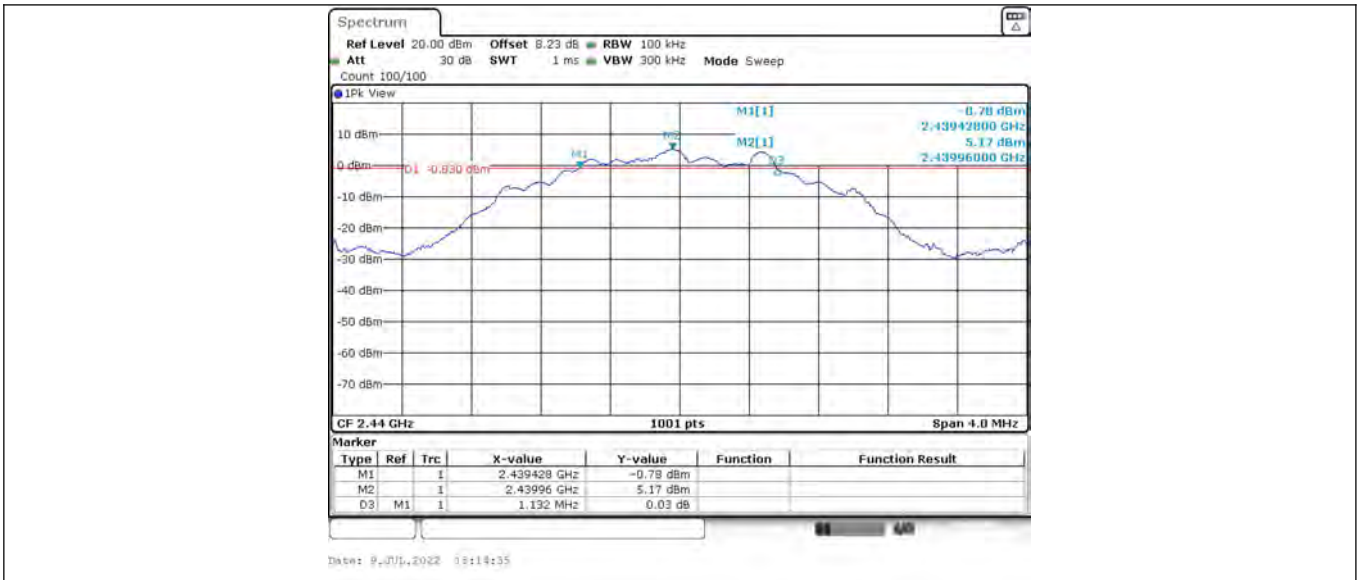

3.8. Duty Cycle

Limit

Test Item	Limit	Frequency Range(MHz)
Duty Cycle	No limit requirement	2400~2483.5

Test Configuration

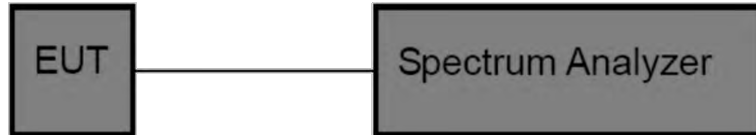

Test Procedure

The zero-span mode on a spectrum analyzer or EMI receiver if the response time and spacing between bins on the sweep are sufficient to permit accurate measurements of the on and off times of the transmitted signal. Set the center frequency of the instrument to the center frequency of the transmission. Set RBW ≥ OBW if possible; otherwise, set RBW to the largest available value. Set VBW ≥ RBW. Set detector = peak or average. The zero-span measurement method shall not be used unless both RBW and VBW are > 50/T and the number of sweep points across duration T exceeds 100. (For example, if VBW and/or RBW are limited to 3 MHz, then the zero-span method of measuring duty cycle shall not be used if T ≤ 16.7 microseconds.)

The transmitter output is connected to the Spectrum Analyzer. We tested according to the zero-span measurement method, 6.0(b) in KDB 558074 D01 DTS Meas Guidance v05r02.

The largest available value of RBW is 8 MHz and VBW is 50 MHz. The zero-span method of measuring duty cycle shall not be used if T ≤ 6.25 microseconds. (50/6.25 = 8)

The zero-span method was used because all measured T data are > 6.25 microseconds and both RBW and VBW are > 50/T.

The RF output of EUT was connected to the spectrum analyzer by RF cable and attenuator.

The path loss was compensated to the results for each measurement.

Set to the maximum power setting and enable the EUT transmit continuously.

The EUT was operating in controlled its channel.

Use the following spectrum analyzer settings:

Span = Zero Span

RBW = 8MHz (the largest available value)

VBW = 8MHz (≥ RBW)

Number of points in Sweep >100

Detector function = peak

Trace = Clear write

Measure Total and Ton

Calculate Duty Cycle = Ton / Total

Test Mode

Please refer to the clause 2.2.

Test Results

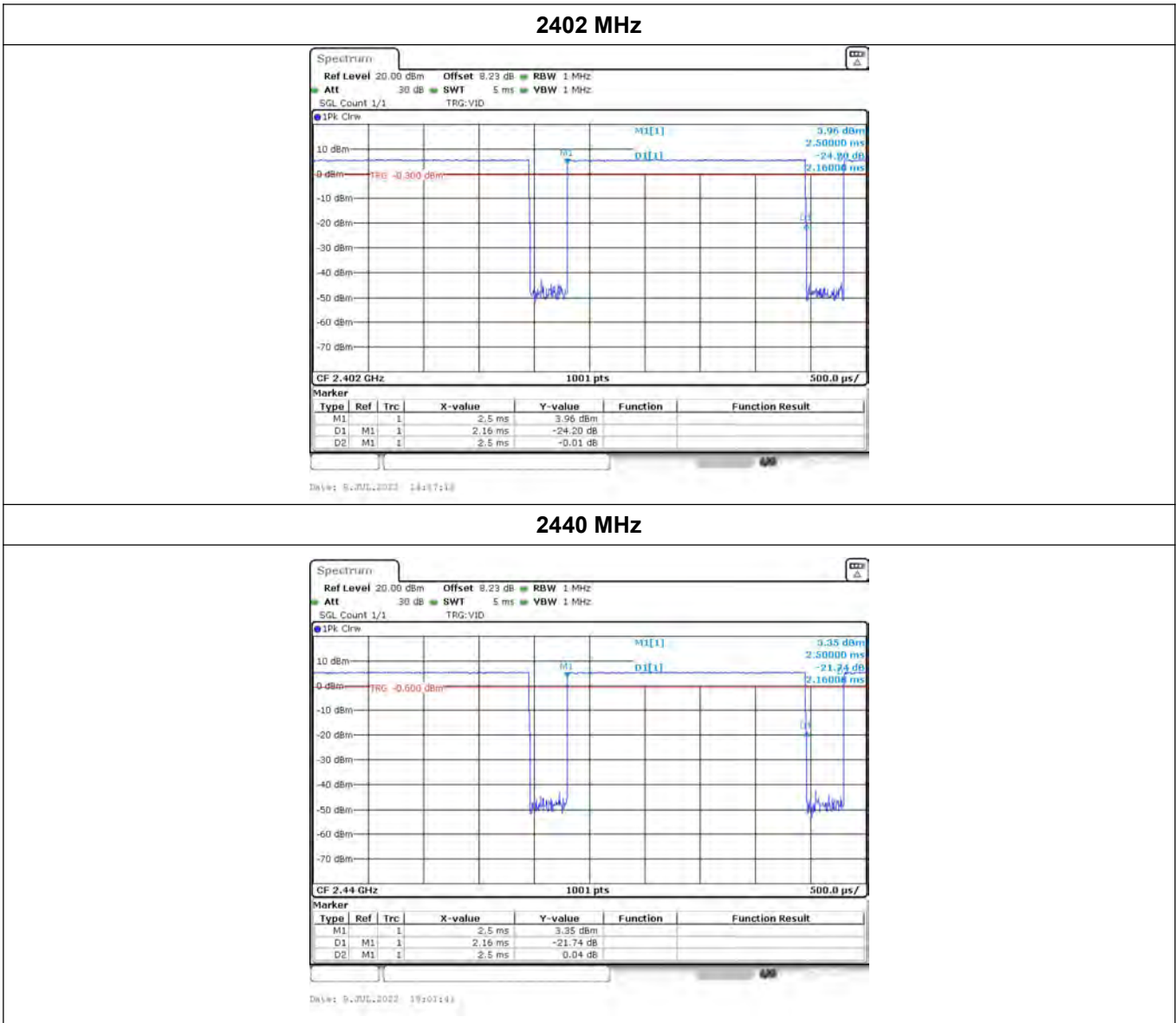

2480 MHz

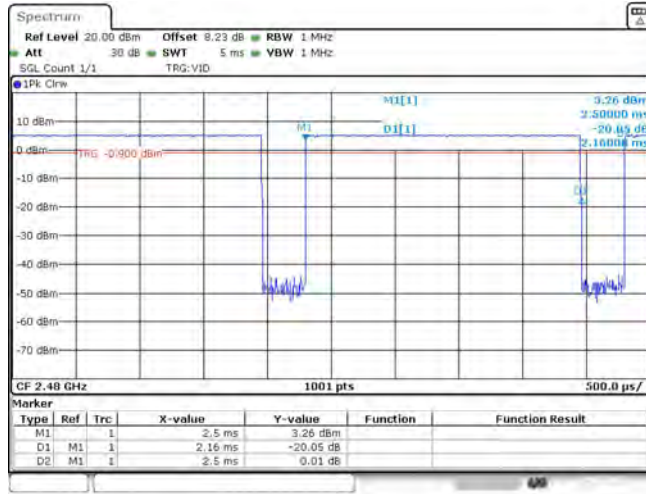

Datw: 9-JUL-2022 19:04:48

3.9. Conducted Band Edge

Limit

FCC CFR Title 47 Part 15 Subpart C Section 15.247 (d):

In any 100 kHz bandwidth outside the frequency band in which the spread spectrum intentional radiator is operating, the radio frequency power that is produced by the intentional radiator shall be at least 20 dB below that in the 100 kHz bandwidth within the band that contains the highest level of the desired power, based on either an RF conducted or a radiated measurement.

Test Configuration

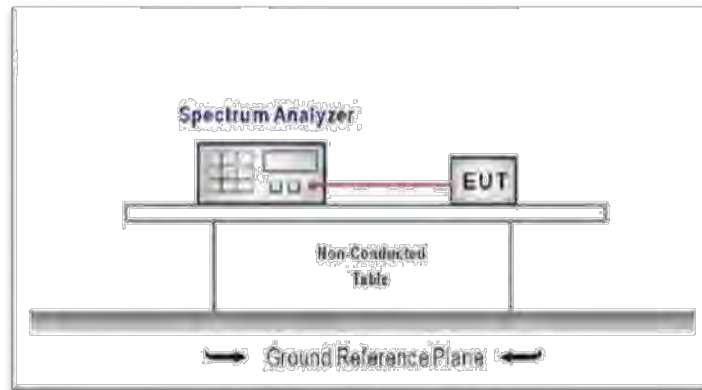

Test Procedure

1. Connect EUT RF Output port to the Spectrum Analyzer through an RF attenuator.
2. Spectrum Setting:
 - RBW=100KHz
 - VBW=300KHz.
 - Detector function: Peak.
 - Trace: Max hold.
 - Sweep = Auto couple.
 - Allow the trace to stabilize.

Test Mode

Please refer to the clause 2.2.

Test Results

GFSK 1Mbps

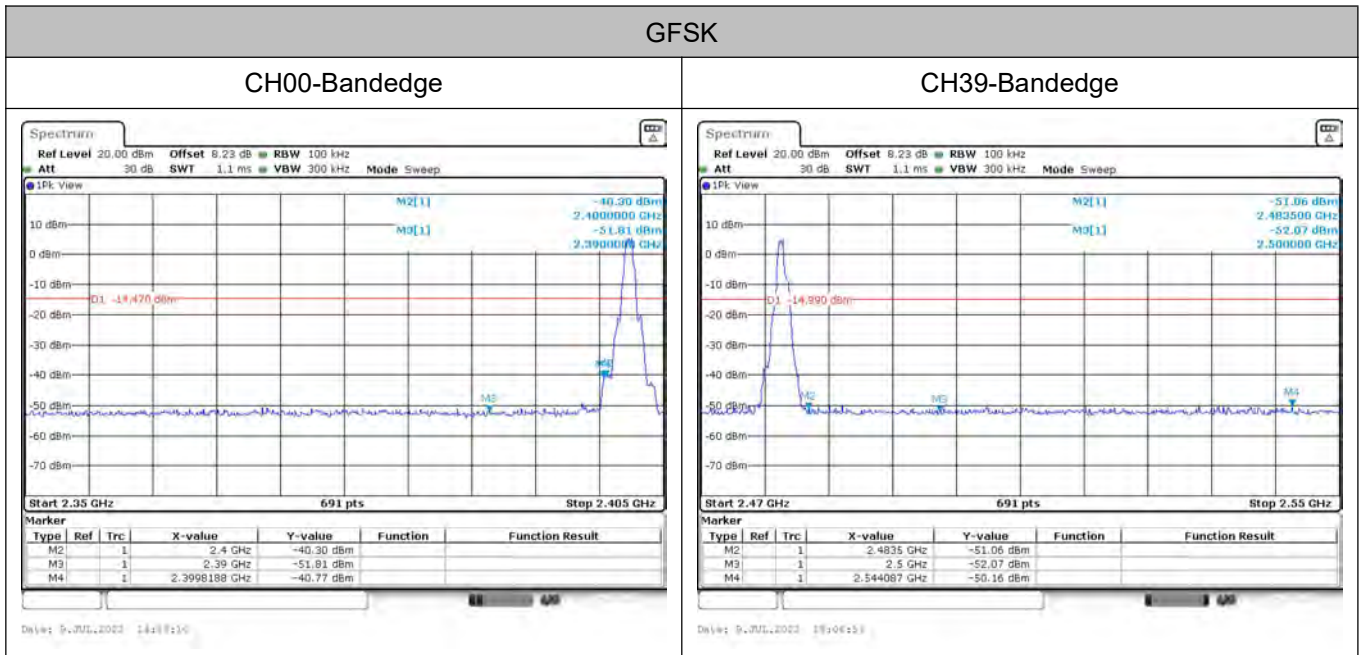

GFSK 2Mbps

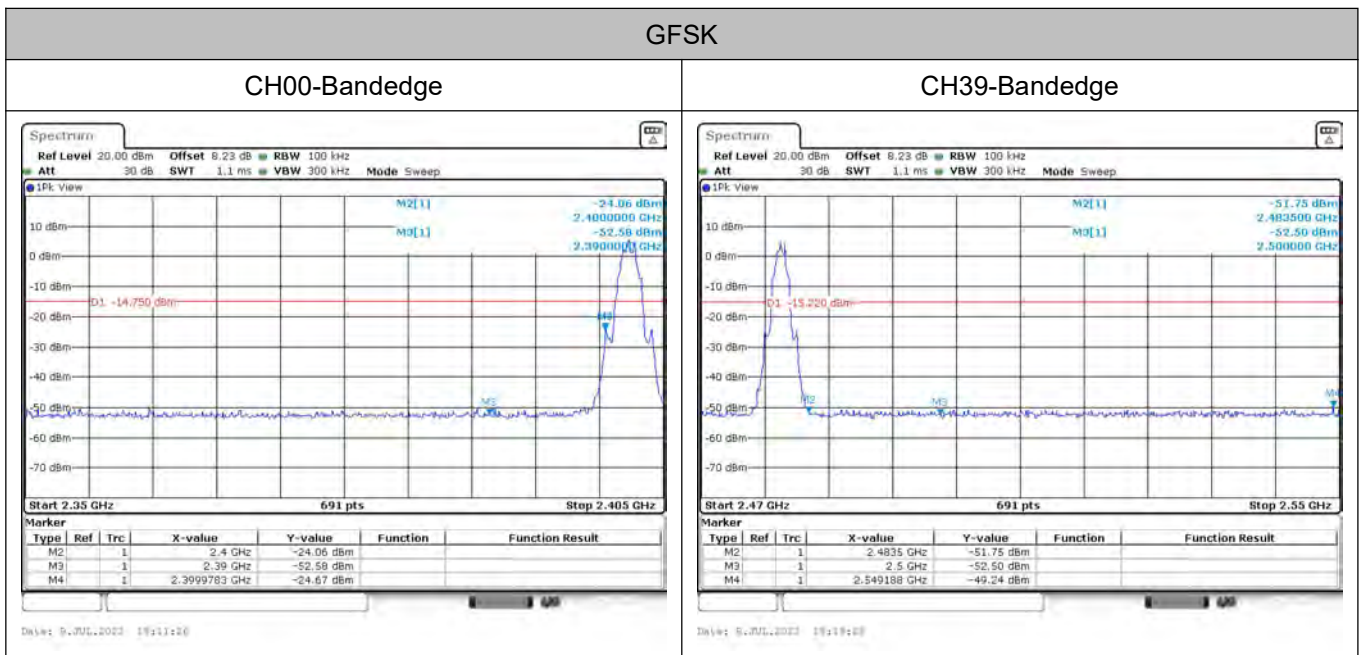

3.10. Spurious RF Conducted Emission

Limit

Below -20dB of the highest emission level in operating band.

Test Configuration

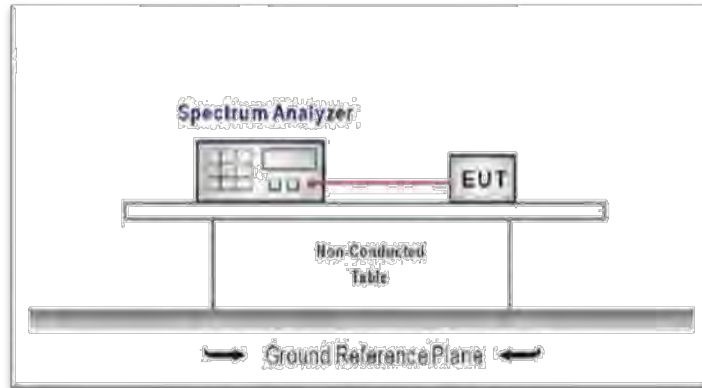

Test Procedure

The Spurious RF conducted emissions compliance of RF radiated emission should be measured by following the guidance in ANSI C63.10-2013 with respect to maximizing the emission by rotating the EUT, measuring the emission while the EUT is situated in three orthogonal planes (if appropriate), adjusting the measurement antenna height and polarization etc. Set RBW=100kHz and VBW= 300kHz to measure the peak field strength, and measure frequency range from 9kHz to 26.5GHz.

Test Mode

Please refer to the clause 2.2.

Test Results

Both modes of BLE 1Mbps and 2Mbps were tested at Low, Middle, and High channel and recorded worst mode at BLE 1Mbps.

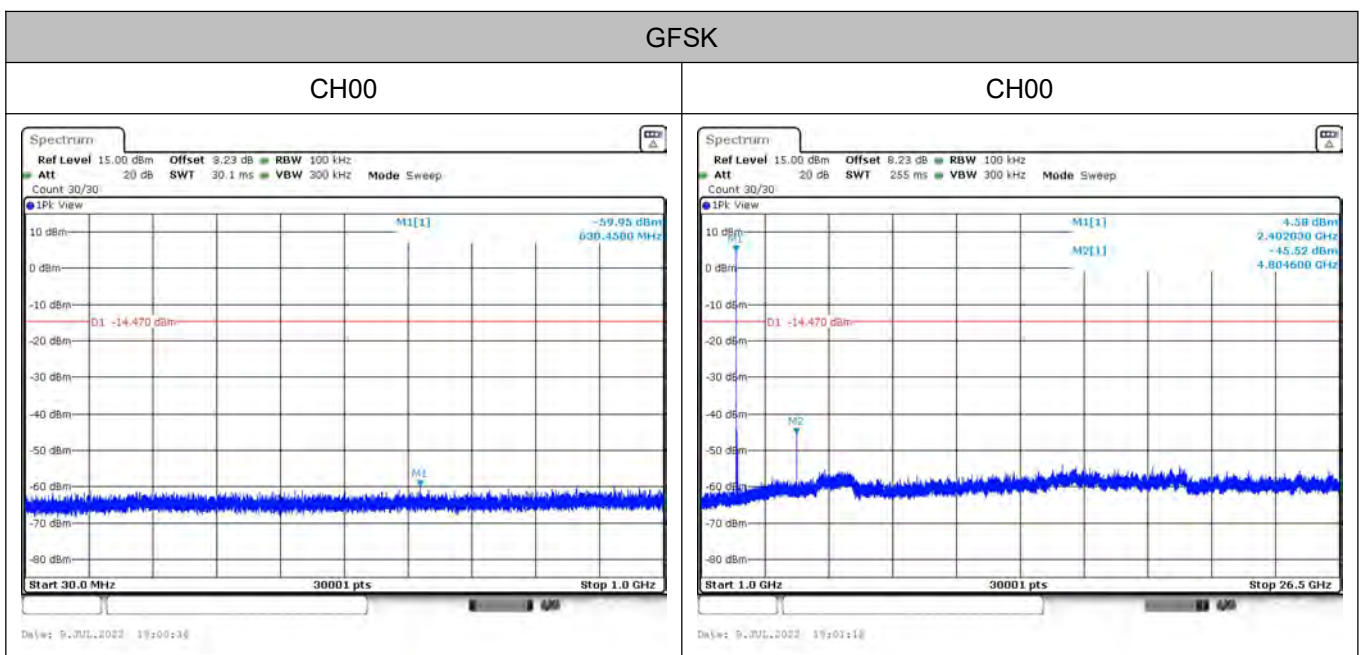

TRF No. FCC Part 15.247_R1

Add : West Side of 1/F., Building C, Zone A, Fuyuan New Factory, Jiujiu Industrial Park, Minzhu, Shatou, Shajing, Bao'an District, Shenzhen, Guangdong, China

Tel : +(86) 0755-2985 2678 Fax: +(86) 0755-2985 2397 E-mail : info@gksign.cn Web: www.gksign.com

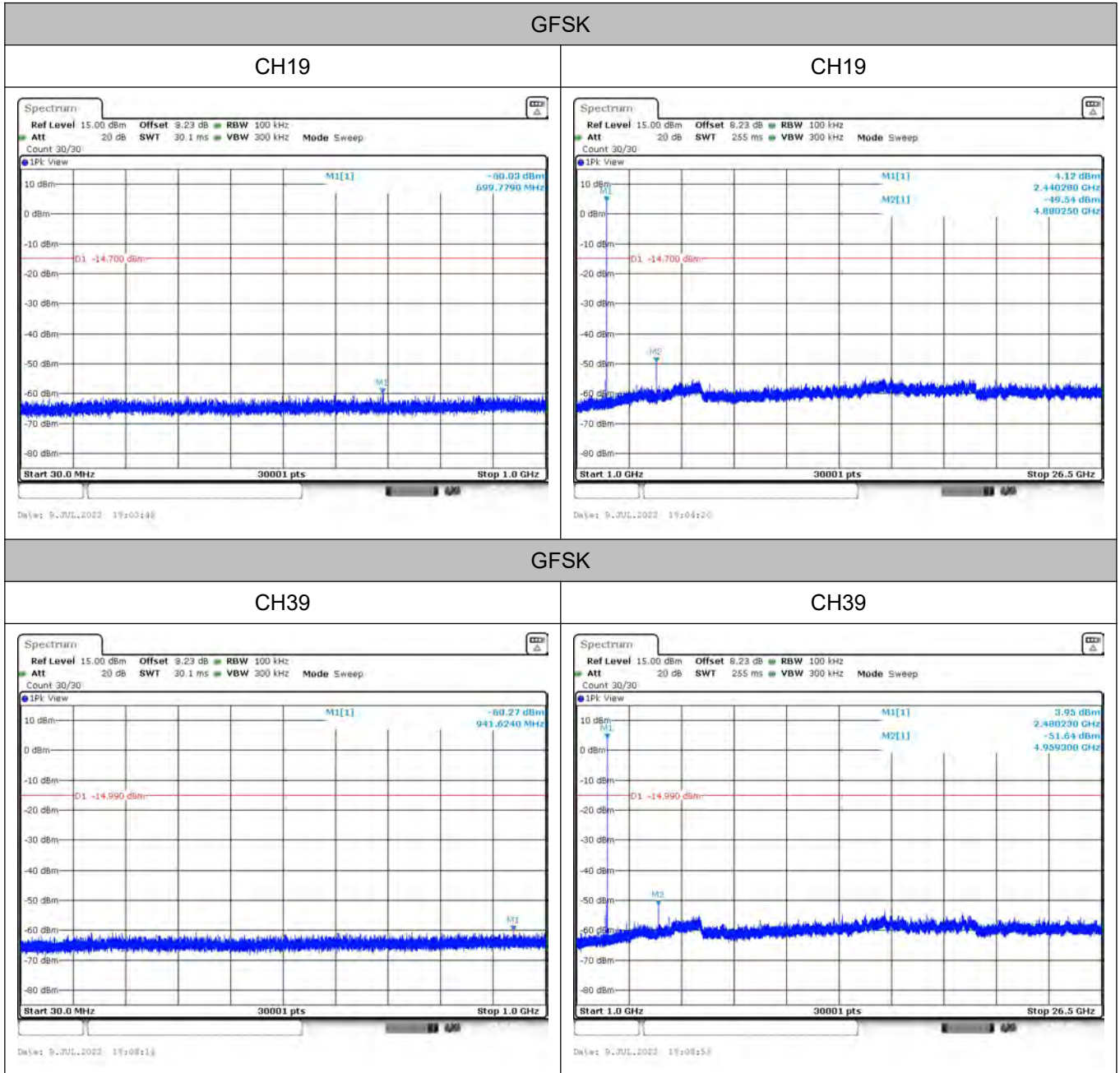

TRF No. FCC Part 15.247_R1

Add : West Side of 1/F., Building C, Zone A, Fuyuan New Factory, Jiujiu Industrial Park, Minzhu, Shatou, Shajing, Bao'an District, Shenzhen, Guangdong, China

Tel : +(86) 0755-2985 2678 Fax: +(86) 0755-2985 2397 E-mail : info@gksign.cn Web: www.gksign.com

4.EUT TEST PHOTOS

Radiated Measurement (Below 1GHz)

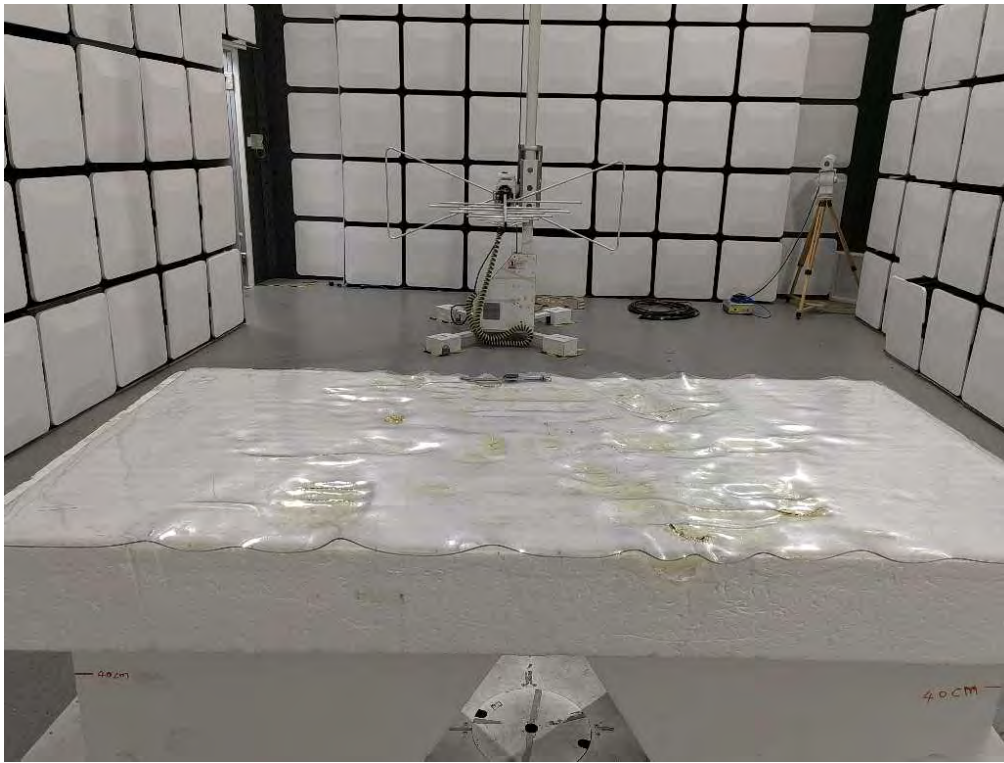

Radiated Measurement (Above 1GHz)



Conducted Emission

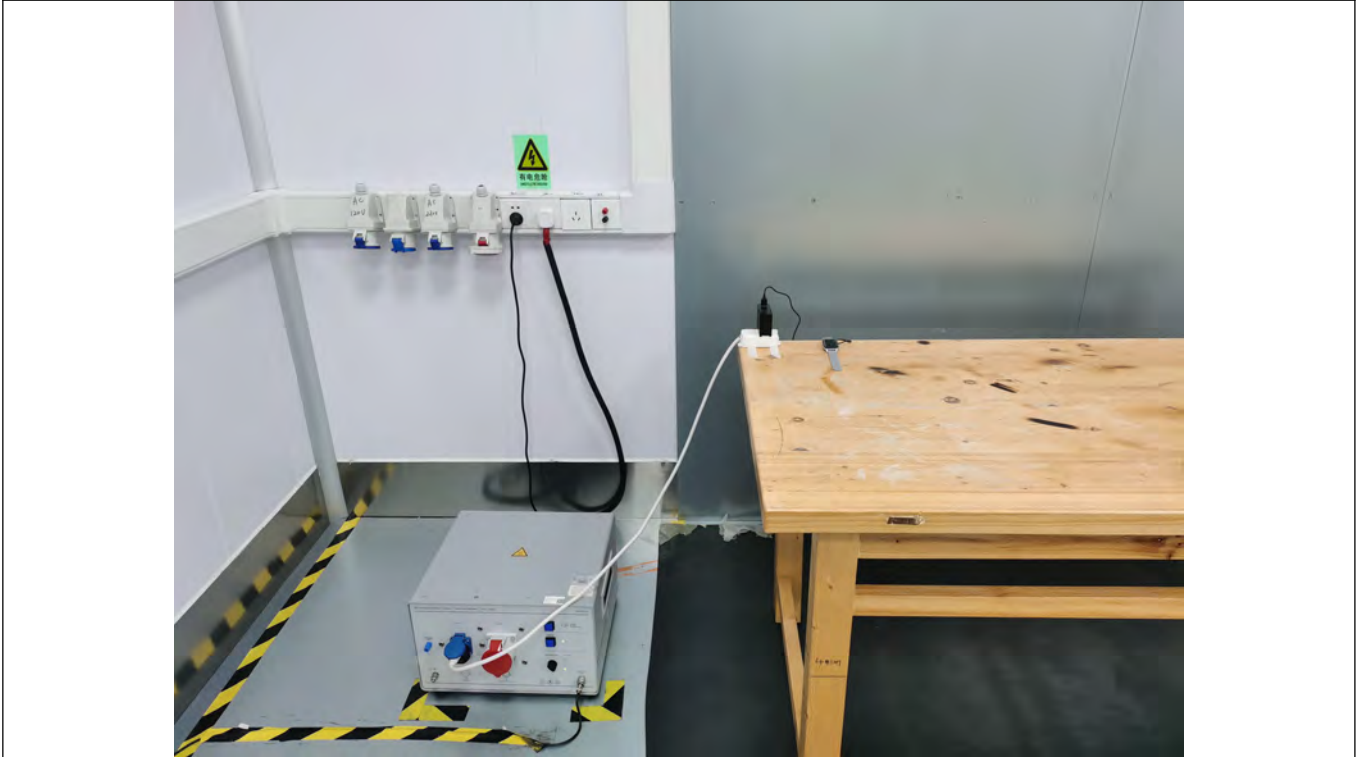

5. PHOTOGRAPHS OF EUT CONSTRUCTIONAL

Please refer to the report Report No.: KS2203S1008E01

--THE END--