

# TEST REPORT

## Client Information:

Applicant: Shenzhen Haoqing Technology Co., LTD  
Applicant add.: Room 405, Zhongtai future Building, No.2007 Baoyuan Road, Xixiang Town, Bao'an District, Shenzhen  
Manufacturer: Shenzhen Haoqing Technology Co., LTD  
Manufacturer add.: Room 405, Zhongtai future Building, No.2007 Baoyuan Road, Xixiang Town, Bao'an District, Shenzhen

## Product Information:

Product Name: EBOOK READER  
Model No.: MEEBOOK M7  
Brand Name: HQ MEEBOOK  
FCC ID: 2A53EMEEBOOKM7

Applicable standards: FCC CFR Title 47 Part 15 Subpart E Section 15.407

## Prepared By:

### Dongguan Yaxu (AiT) Technology Limited

No.22, Jinqianling 3rd Street, Jitigang, Huangjiang, Dongguan,  
Guangdong, China

Tel.: +86-769-8202 0499 Fax.: +86-769-8202 0495

Date of Receipt: May 23, 2023

Date of Test: May 23, 2023~June 28, 2023

Date of Issue: June 29, 2023

Test Result: Pass

This device described above has been tested by Dongguan Yaxu (AiT) Technology Limited and the test results show that the equipment under test (EUT) is in compliance with the FCC requirements. And it is applicable only to the tested sample identified in the report.

Note: This report shall not be reproduced except in full, without the written approval of Dongguan Yaxu (AiT) Technology Limited, this document may be altered or revised by Dongguan Yaxu (AiT) Technology Limited, personal only, and shall be noted in the revision of the document. This test report must not be used by the client to claim product endorsement.

Reviewed by: Simba Huang  
Simba Huang

Approved by: Seal-Chen  
Seal.chen

# 1 Contents

	Page
<b>COVER PAGE</b>	
<b>1 CONTENTS</b> .....	<b>2</b>
<b>2 TEST SUMMARY</b> .....	<b>6</b>
2.1 Statement of the Measurement Uncertainty .....	6
2.2 Measurement Uncertainty .....	6
<b>3 TEST FACILITY</b> .....	<b>7</b>
3.1 Deviation from standard .....	7
3.2 Abnormalities from standard conditions .....	7
3.3 Test Location .....	7
<b>4 GENERAL INFORMATION</b> .....	<b>8</b>
4.1 Test frequencies .....	9
4.2 EUT Peripheral List .....	9
4.3 Test Peripheral List .....	9
4.4 TEST METHODOLOGY .....	10
4.5 Description of Test Modes .....	11
<b>5 EQUIPMENT USED DURING TEST</b> .....	<b>13</b>
<b>6 TEST RESULTS AND MEASUREMENT DATA</b> .....	<b>14</b>
6.1 Antenna requirement .....	14
6.1.1 Standard requirement: .....	14
6.1.2 EUT Antenna: .....	14
6.2 On Time and Duty Cycle .....	15
6.2.1 Standard requirement: .....	15
6.2.2 Measuring Instruments and Setting: .....	15
6.2.3 Test Procedures .....	15
6.2.4 Test Setup Layout .....	15
6.2.5 EUT Operation during Test .....	15
6.2.6 Test result .....	15
6.3 Maximum Conducted Output Power Measurement .....	16
6.3.1 Standard requirement: .....	16
6.3.2 Measuring Instruments: .....	16
6.3.3 Test Procedures: .....	16
6.3.4 Test Setup Layout .....	17
6.3.5 EUT Operation during Test .....	17
6.3.6 Test result .....	17
6.4 26dB Bandwidth Measurement .....	18
6.4.1 Standard requirement: .....	18
6.4.2 Measuring Instruments: .....	18
6.4.3 Test Procedures .....	18

6.4.4	Test Setup Layout .....	18
6.4.5	EUT Operation during Test .....	18
6.4.6	Test result .....	18
6.5	99% Occupied Bandwidth Measurement .....	20
6.5.1	Standard requirement: .....	20
6.5.2	Measuring Instruments: .....	20
6.5.3	Test Procedures .....	20
6.5.4	Test Setup Layout .....	20
6.5.5	EUT Operation during Test .....	20
6.5.6	Test result .....	20
6.6	Power Spectral Density .....	22
6.6.1	Standard requirement: .....	22
6.6.2	Measuring Instruments and Setting: .....	22
6.6.3	Test Procedures .....	22
6.6.4	Test Setup Layout .....	23
6.6.5	EUT Operation during Test .....	23
6.6.6	Test result .....	23
6.7	Undesirable Emissions Measurement .....	24
6.7.1	Standard requirement: .....	24
6.7.2	Measuring Instruments : .....	24
6.7.3	Test Procedures .....	24
6.7.4	Test Setup Layout .....	26
6.7.5	EUT Operation during Test .....	26
6.7.6	Test result .....	26
6.8	Radiated Emissions Measurement .....	27
6.8.1	Standard requirement: .....	27
6.8.2	Measuring Instruments and Setting: .....	28
6.8.3	Test Procedures .....	28
6.8.4	Test Setup Layout .....	31
6.8.5	EUT Operation during Test .....	32
6.8.6	Test result .....	32
6.9	Power Line Conducted Emissions .....	39
6.9.1	Standard requirement: .....	39
6.9.2	Test Setup Layout .....	39
6.9.3	Test Procedures .....	39
6.9.4	EUT Operation during Test .....	39
6.9.5	Test result .....	39
6.10	Frequency Stability .....	42
6.10.1	Standard requirement: .....	42
6.10.2	Measuring Instruments and Setting: .....	42
6.10.3	Test Procedures .....	42
6.10.4	Test Setup Layout .....	42
6.10.5	EUT Operation during Test .....	42
6.10.6	Test result .....	42
<b>7</b>	<b>TEST SETUP PHOTOGRAPHS OF EUT .....</b>	<b>44</b>
<b>8</b>	<b>EXTERNAL PHOTOGRAPHS OF EUT .....</b>	<b>44</b>



---

9 INTERNAL PHOTOGRAPHS OF EUT .....44



**Revision History**

Revision	Issue Date	Revisions	Revised By
000	June 29, 2023	Initial Issue	Seal Chen

## 2 Test Summary

Test Item	Section in CFR 47	Result
/	On Time and Duty Cycle	/
§15.407(a)	Maximum Conducted Output Power	Pass
§15.407(a)	Power Spectral Density	Pass
§15.407(a)	26dB Bandwidth	Pass
§15.209 §15.407(b)	Radiated Emissions	Pass
§15.205	Emissions at Restricted Band	PASS
§15.407(g)	Frequency Stability	Pass
§15.207(a)	Power Line Conducted Emissions	Pass
§15.203	Antenna Requirements	Pass
§2.1093&§2.1091	RF Exposure	Pass*

*Note*

1. Test according to ANSI C63.10:2013.
2. The measurement uncertainty is not included in the test result.
3. “\*” Test results in other test report (RF Exposure Evaluation Report)

### 2.1 Statement of the Measurement Uncertainty

The data and results referenced in this document are true and accurate. The reader is cautioned that there may be errors within the calibration limits of the equipment and facilities. The measurement uncertainty was calculated for all measurements listed in this test report acc. To CISPR 16 – 4 “Specification for radio disturbance and immunity measuring apparatus and methods – Part 4: Uncertainty in EMC Measurements” and is documented in the AiT quality system acc. To DIN EN ISO/IEC 17025. Furthermore, component and process variability of devices similar to that tested may result in additional deviation. The manufacturer has the sole responsibility of continued compliance of the device.

### 2.2 Measurement Uncertainty

Test Item	Frequency Range	Measurement Uncertainty	Notes
Radiated Emission	0.009MHz-30MHz	3.10dB	(1)
Radiated Emission	30MHz-1GHz	3.75dB	(1)
Radiated Emission	1GHz-18GHz	3.88dB	(1)
Radiated Emission	18GHz-40GHz	3.88dB	(1)
AC Power Line Conducted Emission	0.15MHz ~ 30MHz	1.20dB	(1)

Note (1): The measurement uncertainty is for coverage factor of k=2 and a level of confidence of 95%.

### 3 Test Facility

**The test facility is recognized, certified or accredited by the following organizations:**

**.CNAS- Registration No: L6177**

Dongguan Yaxu (AiT) technology Limited is accredited to ISO/IEC 17025:2017 general Requirements for the competence of testing and calibration laboratories (CNAS-CL01 Accreditation Criteria for the competence of testing and calibration laboratories) on April 19, 2022

**FCC-Registration No.: 703111 Designation Number: CN1313**

Dongguan Yaxu (AiT) technology Limited has been registered and fully described in a report filed with the (FCC) Federal Communications Commission. The acceptance letter from the FCC is maintained in our files.

**IC —Registration No.: 6819A CAB identifier: CN0122**

The 3m Semi-anechoic chamber of Dongguan Yaxu (AiT) technology Limited has been registered by Certification and Engineering Bureau of Industry Canada for radio equipment testing with Registration No.: 6819A

**A2LA-Lab Cert. No.: 6317.01**

Dongguan Yaxu (AiT) technology Limited has been accredited by A2LA for technical competence in the field of electrical testing, and proved to be in compliance with ISO/IEC 17025: 2017 General Requirements for the Competence of Testing and Calibration Laboratories and any additional program requirements in the identified field of testing.

#### 3.1 Deviation from standard

None

#### 3.2 Abnormalities from standard conditions

None

#### 3.3 Test Location

**Dongguan Yaxu (AiT) Technology Limited**

Address: No.22, Jinqianling 3rd Street, Jitigang, Huangjiang, Dongguan, Guangdong, China

Tel.: +86-769-8202 0499

Fax.: +86-769-8202 0495

## 4 General Information

EUT Name:	EBOOK READER			
Model No:	MEEBOOK M7			
Serial Model:	N/A			
Test sample(s) ID:	23052306-1			
Sample(s) Status:	Engineer sample			
Operation frequency:	Band	Mode	Frequency Range(MHz)	Number of channels
	U-NII Band I	IEEE 802.11a	5180-5240	4
		IEEE 802.11n/ac 20MHz	5180-5240	4
		IEEE 802.11n/ac 40MHz	5190-5230	2
		IEEE 802.11ac 80MHz	5210	1
	U-NII Band II-A	IEEE 802.11a	5260-5320	4
		IEEE 802.11n/ac 20MHz	5260-5320	4
		IEEE 802.11n/ac 40MHz	5270-5310	2
		IEEE 802.11ac 80MHz	5290	1
	U-NII Band II-C	IEEE 802.11a	5500-5700	11
		IEEE 802.11n/ac 20MHz	5500-5700	11
		IEEE 802.11n/ac 40MHz	5510-5670	5
		IEEE 802.11ac 80MHz	5530-5610	2
Modulation Technology:	OFDM			
Modulation Type	IEEE 802.11a/n/ac: OFDM(64QAM, 16QAM, QPSK, BPSK)			
Antenna Type:	FPC antenna			
Antenna gain:	5150MHz-5250MHz:1.51dBi 5250MHz-5350MHz:1.63dBi 5470MHz-5725MHz:1.80dBi			
Hardware version.:	N/A			
Software version.:	N/A			
Power supply:	DC3.8V from battery or DC5V from adapter			
Model different:	N/A			
Note:	For a more detailed features description, please refer to the manufacturer's specifications or the User's Manual.			



### 4.1 Test frequencies

EUT channels and frequencies list:

Channel list for 802.11a/n(HT20)/ac(VHT20)							
Channel	Frequency	Channel	Frequency	Channel	Frequency	Channel	Frequency
36	5180MHz	40	5200MHz	44	5220MHz	48	5240MHz
52	5260MHz	56	5280MHz	60	5300MHz	64	5320MHz
100	5500MHz	104	5520MHz	108	5540MHz	112	5560MHz
116	5580MHz	120	5600MHz	124	5620MHz	128	5640MHz
132	5660MHz	136	5680MHz	140	5700MHz	-	-

Channel list for 802.11n(HT40)/ac(VHT40)							
Channel	Frequency	Channel	Frequency	Channel	Frequency	Channel	Frequency
38	5190MHz	46	5230MHz	54	5270MHz	62	5310MHz
102	5510MHz	110	5550MHz	118	5590MHz	126	5630MHz
134	5670MHz	-	-	-	-	-	-

Channel list for 802.11ac(HT80)							
Channel	Frequency	Channel	Frequency	Channel	Frequency	Channel	Frequency
42	5210MHz	58	5290MHz	106	5530MHz	122	5610MHz

### 4.2 EUT Peripheral List

No.	Equipment	Manufacturer	EMC Compliance	Model No.	Serial No.	Power cord	Signal cord
1	N/A	N/A	N/A	N/A	N/A	N/A	N/A

### 4.3 Test Peripheral List

No.	Equipment	Manufacturer	EMC Compliance	Model No.	Serial No.	Power cord	Signal cord
1	Adapter	NOKIA	CE	AD-10WU	N/A	N/A	N/A

## 4.4 TEST METHODOLOGY

All measurements contained in this report were conducted with ANSI C63.10-2013, American National Standard of Procedures for Compliance Testing of Unlicensed Wireless Devices.

The radiated testing was performed at an antenna-to-EUT distance of 3 meters. All radiated and conducted emissions measurement was performed at Dongguan Yaxu (AiT) Technology Limited

### 4.4.1 EUT Configuration

The EUT configuration for testing is installed on RF field strength measurement to meet the Commissions requirement and operating in a manner that intends to maximize its emission characteristics in a continuous normal application.

### 4.4.2 EUT Exercise

The EUT was operated in the engineering mode to fix the TX frequency that was for the purpose of the measurements.

According to FCC's request, Test Procedure 789033 D02 General UNII Test Procedures New Rules v01r03 and KDB 662911 D01 Multiple Transmitter Output v02r01 is required to be used for this kind of FCC 15.407 UII device.

According to its specifications, the EUT must comply with the requirements of the Section 15.203, 15.205, 15.207, 15.209 and 15.407 under the FCC Rules Part 15 Subpart E

### 4.4.3 General Test Procedures

#### Conducted Emissions

The EUT is placed on the turntable, which is 0.8 m above ground plane. According to the requirements in Section 6.2.1 of ANSI C63.10-2013 Conducted emissions from the EUT measured in the frequency range between 0.15 MHz and 30MHz using Quasi-peak and average detector modes.

#### Radiated Emissions

The EUT is placed on a turn table, which is 0.8 m above ground plane. The turntable shall rotate 360 degrees to determine the position of maximum emission level. EUT is set 3m away from the receiving antenna, which varied from 1m to 4m to find out the highest emission. And also, each emission was to be maximized by changing the polarization of receiving antenna both horizontal and vertical. In order to find out the maximum emissions, exploratory radiated emission measurements were made according to the requirements in Section 6.3 of ANSI C63.10-2013.

#### 4.5 Description of Test Modes

The EUT has been tested under operating condition.

This test was performed with EUT in X, Y, Z position and the worst case was found when EUT in X position.

AC main conducted emission pre-test voltage at both AC 120V/60Hz and AC 240V/50Hz, recorded worst case;

AC main conducted emission pre-test at charge from power adapter modes, recorded worst case;

Worst-case mode and channel used for 9 KHz-1000 MHz radiated emissions was the mode and channel with the highest output power, that was determined to be IEEE 802.11ac VHT20 mode (HCH).

Worst-Case data rates were utilized from preliminary testing of the Chipset, worst-case data rates used during the testing are as follows:

- IEEE 802.11a Mode: 6 Mbps, OFDM.
- IEEE 802.11ac VHT20 Mode: MCS0
- IEEE 802.11n HT20 Mode: MCS0, OFDM.
- IEEE 802.11ac VHT40 Mode: MCS0, OFDM.
- IEEE 802.11n HT40 Mode: MCS0, OFDM.
- IEEE 802.11ac VHT80 Mode: MCS0, OFDM.

In section 15.31(m), regards to the operating frequency range over 10 MHz, the Lowest frequency, the middle frequency, and the highest frequency of channel were selected to perform the test, and the selected channel see below:

Transmitting mode	Keep the EUT in continuously transmitting mode.					
Test software:	CMD					
Frequency	5180 MHz	5200 MHz	5240 MHz	5260 MHz	5280 MHz	5320 MHz
Parameters(802.11a)	Default	Default	Default	Default	Default	Default
Parameters(802.11n20)	Default	Default	Default	Default	Default	Default
Parameters(802.11ac20)	Default	Default	Default	Default	Default	Default
Frequency	5190 MHz	5230 MHz	5270 MHz	5310 MHz	--	--
Parameters(802.11n40)	Default	Default	Default	Default	--	--
Parameters(802.11ac40)	Default	Default	Default	Default		
Frequency	5210 MHz	5290 MHz		--	--	--
Parameters(802.11ac80)	Default	Default		--	--	--

Transmitting mode	Keep the EUT in continuously transmitting mode.					
Test software:	CMD					
Frequency	5500 MHz	5600 MHz	5700 MHz	--	--	--
Parameters(802.11a)	Default	Default	Default	--	--	--
Parameters(802.11n20)	Default	Default	Default	--	--	--
Parameters(802.11ac20)	Default	Default	Default			
Frequency	5510 MHz	5670 MHz	--	--	--	--
Parameters(802.11n40)	Default	Default	--	--	--	--
Parameters(802.11ac40)	Default	Default				
Frequency	5530 MHz	5610 MHz	--	--	--	--
Parameters(802.11ac80)	Default	Default	--	--	--	--

**Antenna & Bandwidth**

Antenna	Chain 1 (ANT1)			Chain 2 (ANT2)			Simultaneously
Bandwidth Mode	20MHz	40MHz	80MHz	20MHz	40MHz	80MHz	/
IEEE 802.11a	<input checked="" type="checkbox"/>	<input type="checkbox"/>	<input type="checkbox"/>	<input type="checkbox"/>	<input type="checkbox"/>	<input type="checkbox"/>	<input type="checkbox"/>
IEEE 802.11n	<input checked="" type="checkbox"/>	<input checked="" type="checkbox"/>	<input type="checkbox"/>	<input type="checkbox"/>	<input type="checkbox"/>	<input type="checkbox"/>	<input type="checkbox"/>
IEEE 802.11ac	<input checked="" type="checkbox"/>	<input checked="" type="checkbox"/>	<input checked="" type="checkbox"/>	<input type="checkbox"/>	<input type="checkbox"/>	<input type="checkbox"/>	<input type="checkbox"/>

## 5 Equipment Used during Test

No	Test Equipment	Manufacturer	Model No	Serial No	Cal. Date	Cal. Due Date
1	Spectrum Analyzer	R&S	FSV40	101470	2022.09.02	2023.09.01
2	EMI Measuring Receiver	R&S	ESR	101660	2022.09.02	2023.09.01
3	Low Noise Pre Amplifier	HP	HP8447E	1937A01855	2022.09.02	2023.09.01
4	Low Noise Pre Amplifier	Tsj	MLA-0120-A02-34	2648A04738	2022.09.02	2023.09.01
5	Passive Loop	ETS	6512	00165355	2022.09.04	2024.09.03
6	TRILOG Super Broadband test Antenna	SCHWARZBECK	VULB9160	9160-3206	2021.08.29	2024.08.28
7	Broadband Horn Antenna	SCHWARZBECK	BBHA9120D	452	2021.08.29	2024.08.28
8	SHF-EHF Horn Antenna 15-40GHz	SCHWARZBECK	BBHA9170	BBHA9170367d	2020.11.24	2023.11.23
9	EMI Test Receiver	R&S	ESCI	100124	2022.09.02	2023.09.01
10	LISN	Kyoritsu	KNW-242	8-837-4	2022.09.02	2023.09.01
11	LISN	R&S	ESH3-Z2	0357.8810.54-101161-S2	2022.09.02	2023.09.01
12	Pro.Temp&Humi.chamber	MENTEK	MHP-150-1C	MAA08112501	2022.09.02	2023.09.01
13	RF Automatic Test system	MW	MW100-RFCB	21033016	2022.09.02	2023.09.01
14	Signal Generator	Agilent	N5182A	MY50143009	2022.09.02	2023.09.01
15	Wideband Radio communication tester	R&S	CMW500	1201.0002K50	2022.09.02	2023.09.01
16	RF Automatic Test system	MW	MW100-RFCB	21033016	2022.09.02	2023.09.01
17	DC power supply	ZHAOXIN	RXN-305D-2	28070002559	N/A	N/A
18	RE Software	EZ	EZ-EMC_RE	Ver.AIT-03A	N/A	N/A
19	CE Software	EZ	EZ-EMC_CE	Ver.AIT-03A	N/A	N/A
20	RF Software	MW	MTS 8310	2.0.0.0	N/A	N/A
21	temporary antenna connector(Note)	NTS	R001	N/A	N/A	N/A

Note: The temporary antenna connector is soldered on the PCB board in order to perform conducted tests and this temporary antenna connector is listed in the equipment list.

## 6 Test results and Measurement Data

### 6.1 Antenna requirement

#### 6.1.1 Standard requirement:

For intentional device, according to FCC 47 CFR Section 15.203:

An intentional radiator shall be designed to ensure that no antenna other than that furnished by the responsible party shall be used with the device. The use of a permanently attached antenna or of an antenna that uses a unique coupling to the intentional radiator, the manufacturer may design the unit so that a broken antenna can be replaced by the user, but the use of a standard antenna jack or electrical connector is prohibited

And according to FCC 47 CFR Section 15.407 (a), if transmitting antennas of directional gain greater than 6dBi are used, the power shall be reduced by the amount in dB that the directional gain of the antenna exceeds 6dBi.

According to § 15.203 & RSS-Gen, an intentional radiator shall be designed to ensure that no antenna other than that furnished by the responsible party shall be used with the device.

#### 6.1.2 EUT Antenna:

*The ant Sdetails*

## 6.2 On Time and Duty Cycle

### 6.2.1 Standard requirement:

None; for reporting purpose only

### 6.2.2 Measuring Instruments and Setting:

Please refer to equipments list in this report. The following table is the setting of the spectrum analyser.

### 6.2.3 Test Procedures

- 1). Set the Centre frequency of the spectrum analyzer to the transmitting frequency;
- 2). Set the span=0MHz, RBW=8MHz, VBW=50MHz, Sweep time=10.13ms;
- 3). Detector = peak;
- 4). Trace mode = Single hold.

### 6.2.4 Test Setup Layout

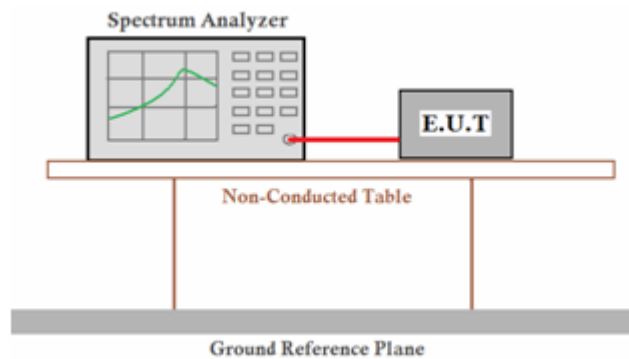

### 6.2.5 EUT Operation during Test

The EUT was programmed to be in continuously transmitting mode.

### 6.2.6 Test result

*For reporting purpose only.*

*Please refer to Appendix D.1*

*Please refer to Appendix F.1*

*Please refer to Appendix G.1*

## 6.3 Maximum Conducted Output Power Measurement

### 6.3.1 Standard requirement:

#### (1) For the band 5.15~5.25GHz

- (i) For an outdoor access point operating in the band 5.15-5.25 GHz, the maximum conducted output power over the frequency band of operation shall not exceed 1 W provided the maximum antenna gain does not exceed 6 dBi. If transmitting antennas of directional gain greater than 6 dBi are used, both the maximum conducted output power and the maximum power spectral density shall be reduced by the amount in dB that the directional gain of the antenna exceeds 6 dBi. The maximum e.i.r.p. at any elevation angle above 30 degrees as measured from the horizon must not exceed 125 mW (21 dBm).
- (ii) For an indoor access point operating in the band 5.15-5.25 GHz, the maximum conducted output power over the frequency band of operation shall not exceed 1 W provided the maximum antenna gain does not exceed 6 dBi. If transmitting antennas of directional gain greater than 6 dBi are used, both the maximum conducted output power and the maximum power spectral density shall be reduced by the amount in dB that the directional gain of the antenna exceeds 6 dBi.
- (iii) For fixed point-to-point access points operating in the band 5.15-5.25 GHz, the maximum conducted output power over the frequency band of operation shall not exceed 1 W. Fixed point-to-point U-NII devices may employ antennas with directional gain up to 23 dBi without any corresponding reduction in the maximum conducted output power. For fixed point-to-point transmitters that employ a directional antenna gain greater than 23 dBi, a 1dB reduction in maximum conducted output power is required for each 1 dB of antenna gain in excess of 23 dBi. Fixed, point-to-point operations exclude the use of point-to-multipoint systems, omnidirectional applications, and multiple collocated transmitters transmitting the same information. The operator of the U-NII device, or if the equipment is professionally installed, the installer, is responsible for ensuring that systems employing high gain directional antennas are used exclusively for fixed, point-to-point operations.
- (iv) For mobile and portable client devices in the 5.15-5.25 GHz band, the maximum conducted output power over the frequency band of operation shall not exceed 250 mW provided the maximum antenna gain does not exceed 6 dBi. If transmitting antennas of directional gain greater than 6 dBi are used, both the maximum conducted output power shall be reduced by the amount in dB that the directional gain of the antenna exceeds 6 dBi.

#### (2) For the band 5.25-5.35 GHz and 5.47-5.725 GHz

The maximum conducted output power over the frequency bands of operation shall not exceed the lesser of 250 mW or  $11 \text{ dBm} + 10 \log B$ , where B is the 26 dB emission bandwidth in megahertz. If transmitting antennas of directional gain greater than 6 dBi are used, both the maximum conducted output power and the maximum power spectral density shall be reduced by the amount in dB that the directional gain of the antenna exceeds 6 dBi.

### 6.3.2 Measuring Instruments:

Please refer to equipment's list in this report.

### 6.3.3 Test Procedures:

The transmitter output (antenna port) was connected to the power meter.

According to KDB 789033 D02 v02r01 Section 3 (a) Method PM (Measurement using an RF average power meter):

- (i) Measurements may be performed using a wideband RF power meter with a thermocouple detector or equivalent if all of the conditions listed below are satisfied.

- The EUT is configured to transmit continuously or to transmit with a constant duty cycle.



- At all times when the EUT is transmitting, it must be transmitting at its maximum power control level.
  - The integration period of the power meter exceeds the repetition period of the transmitted signal by at least a factor of five.
- (ii) If the transmitter does not transmit continuously, measure the duty cycle,  $x$ , of the transmitter output signal as described in section II.B.
- (iii) Measure the average power of the transmitter. This measurement is an average over both the on and off periods of the transmitter.
- (iv) Adjust the measurement in dBm by adding  $10 \log (1/x)$  where  $x$  is the duty cycle (e.g.,  $10 \log (1/0.25)$  if the duty cycle is 25%).

### 6.3.4 Test Setup Layout

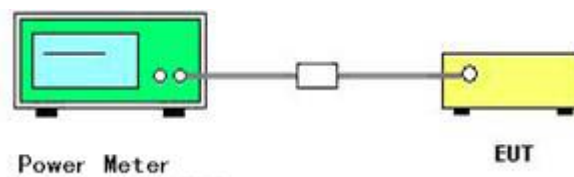

### 6.3.5 EUT Operation during Test

The EUT was programmed to be in continuously transmitting mode.

### 6.3.6 Test result

PASS

Please refer to Appendix D.2

Please refer to Appendix F.2

Please refer to Appendix G.2

Remark:

1. Measured output power at difference data rate for each mode and recorded worst case for each mode.
2. Test results including cable loss;
3. Worst case data at 6Mbps at IEEE 802.11a; MCS0 at IEEE 802.11n HT20, IEEE 802.11n HT40, IEEE 802.11ac VHT80;
4. Report conducted power = Measured conducted average power + Duty Cycle factor;
5. For power measurements on IEEE 802.11 devices;
  - Array Gain = 0 dB (i.e., no array gain) for  $NANT \leq 4$ ;
  - Array Gain = 0 dB (i.e., no array gain) for channel widths  $\geq 40$  MHz for any NANT;
  - Array Gain =  $5 \log (NANT/NSS)$  dB or 3 dB, whichever is less, for 20-MHz channel widths with  $NANT \geq 5$

## 6.4 26dB Bandwidth Measurement

### 6.4.1 Standard requirement:

No restriction limits. But resolution bandwidth within band edge measurement is 1% of the 99% occupied bandwidth.

### 6.4.2 Measuring Instruments:

Please refer to equipment list in this report. The following table is the setting of the Spectrum Analyzer.

Spectrum Parameter	Setting
Attenuation	Auto
Span	> 26dB Bandwidth
Detector	Peak
Trace	Max Hold
Sweep Time	100ms

### 6.4.3 Test Procedures

1. The transmitter output (antenna port) was connected to the spectrum analyzer in peak hold mode.
2. The RBW = 1% - 3% of occupied bandwidth, VBW = 3\*RBW;
3. Measured the spectrum width with power higher than 26dB below carrier.

### 6.4.4 Test Setup Layout

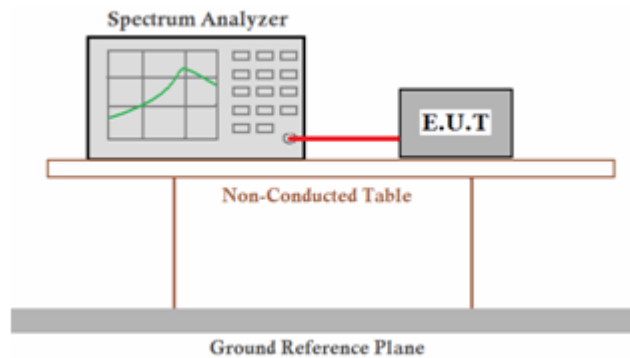

### 6.4.5 EUT Operation during Test

The EUT was programmed to be in continuously transmitting mode.

### 6.4.6 Test result

PASS

Please refer to Appendix D.4

Please refer to Appendix F.4

Please refer to Appendix G.4

**Remark:**

1. *Measured 26dB bandwidth at difference data rate for each mode and recorded worst case for each mode.*
2. *Test results including cable loss;*
3. *Worst case data at 6Mbps at IEEE 802.11a; MCS0 at IEEE 802.11n HT20, IEEE 802.11n HT40, IEEE 802.11ac VHT80;*

## 6.5 99% Occupied Bandwidth Measurement

### 6.5.1 Standard requirement:

According to §2.1049: The occupied bandwidth, that is the frequency bandwidth such that, below its lower and above its upper frequency limits, the mean powers radiated are each equal to 0.5 percent of the total mean power radiated by a given emission shall be measured under the following conditions as applicable.

### 6.5.2 Measuring Instruments:

Please refer to equipment list in this report. The following table is the setting of the Spectrum Analyzer.

Spectrum Parameter	Setting
Attenuation	Auto
RBW	> RBW
VBW	Peak
Span Frequency	Max Hold
Detector	100ms

### 6.5.3 Test Procedures

1. The transmitter output (antenna port) was connected to the spectrum analyzer in peak hold mode.
2. Set RBW = 1%~5% OBW; VBW ≥ 3\*RBW;
3. Measured the 99% occupied bandwidth by related function of the spectrum analyzer.

### 6.5.4 Test Setup Layout

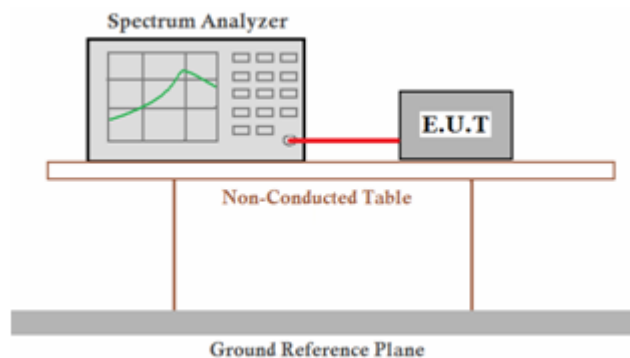

### 6.5.5 EUT Operation during Test

The EUT was programmed to be in continuously transmitting mode.

### 6.5.6 Test result

PASS

Please refer to Appendix D.4

Please refer to Appendix F.4

Please refer to Appendix G.4

*Remark:*

1. *Measured 99% bandwidth at difference data rate for each mode and recorded worst case for each mode.*
2. *Test results including cable loss;*
3. *Worst case data at 6Mbps at IEEE 802.11a; MCS0 at IEEE 802.11n HT20, IEEE 802.11n HT40, IEEE 802.11ac VHT80;*

## 6.6 Power Spectral Density

### 6.6.1 Standard requirement:

#### For 5.15~5.25GHz

- (i) For an outdoor access point operating in the band 5.15 - 5.25 GHz, the maximum power spectral density shall not exceed 17 dBm in any 1 MHz band.note1
- (ii) For an indoor access point operating in the band 5.15 - 5.25 GHz, the maximum power spectral density shall not exceed 17 dBm in any 1 MHz band.note1
- (iii) For fixed point-to-point access points operating in the band 5.15 - 5.25 GHz, transmitters that employ a directional antenna gain greater than 23 dBi, a 1 dB reduction in maximum power spectral density is required for each 1 dB of antenna gain in excess of 23 dBi.
- (iv) For mobile and portable client devices in the 5.15 - 5.25 GHz band, the maximum power spectral density shall not exceed 11 dBm in any 1 MHz band. note1

Note1: If transmitting antennas of directional gain greater than 6 dBi are used, the peak power spectral density shall be reduced by the amount in dB that the directional gain of the antenna exceeds 6 dBi.

#### For the band 5.25-5.35 GHz and 5.47-5.725 GHz

The maximum power spectral density shall not exceed 11 dBm in any 1 megahertz band. If transmitting antennas of directional gain greater than 6 dBi are used, the peak power spectral density shall be reduced by the amount in dB that the directional gain of the antenna exceeds 6 dBi.

### 6.6.2 Measuring Instruments and Setting:

Please refer to equipment list in this report. The following table is the setting of Spectrum Analyzer.

### 6.6.3 Test Procedures

1. Use this procedure when the maximum peak conducted output power in the fundamental 1). The transmitter was connected directly to a Spectrum Analyzer through a directional couple.
- 2). The power was monitored at the coupler port with a Spectrum Analyzer. The power level was set to the maximum level.
- 3). Set the RBW = 1MHz.
- 4). Set the VBW  $\geq$  3MHz
- 5). Span=Encompass the entire emissions bandwidth (EBW) of the signal (or, alternatively, the entire 99% occupied bandwidth) of the signal.
- 6). Number of points in sweep  $\geq 2 \times \text{span} / \text{RBW}$ . (This ensures that bin-to-bin spacing is  $\leq \text{RBW}/2$ , so that narrowband signals are not lost between frequency bins.)
- 7). Manually set sweep time  $\geq 10 \times (\text{number of points in sweep}) \times (\text{total on/off period of the transmitted signal})$ .
- 8). Set detector = power averaging (rms).
- 9). Sweep time = auto couple.
- 10). Trace mode = max hold.
- 11). Allow trace to fully stabilize.
- 12). Compute power by integrating the spectrum across the EBW (or, alternatively, the entire 99% occupied bandwidth) of the signal using the instrument's band power measurement function with band limits set equal to the EBW (or occupied bandwidth) band edges. If the instrument does not have a band power function, sum the spectrum levels (in power units) at 1 MHz intervals extending across the EBW (or, alternatively, levels (in power units) at 1 MHz intervals extending across the EBW (or, alternatively).
- 13). Add  $10 \log (1/x)$ , where x is the duty cycle, to the measured power in order to compute the average power during the actual transmission times (because the measurement represents an average over both the on and off times of the transmission). For example, add  $10 \log (1/0.25) = 6$  dB if the duty cycle is 25%.
- 14). Use the peak marker function to determine the maximum power level in any 1MHz band segment within the fundamental EBW.

### 6.6.4 Test Setup Layout

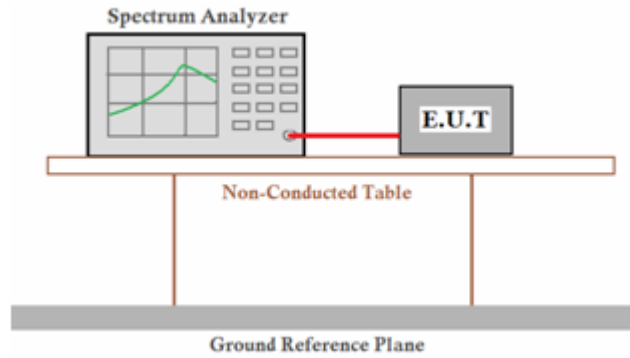

### 6.6.5 EUT Operation during Test

The EUT was programmed to be in continuously transmitting mode.

### 6.6.6 Test result

PASS

Please refer to Appendix D.3

Please refer to Appendix F.3

Please refer to Appendix G.3

Remark:

1. Measured power spectrum density at difference data rate for each mode and recorded worst case for each mode.
2. Test results including cable loss;
3. Worst case data at 6Mbps at IEEE 802.11a; MCS0 at IEEE 802.11n HT20, IEEE 802.11n HT40, IEEE 802.11ac VHT80;

Report conducted PSD = Measured conducted average power + Duty Cycle factor;

## 6.7 Undesirable Emissions Measurement

### 6.6.1 Standard requirement:

According to §15.407 (b) Undesirable emission limits. Except as shown in paragraph (b) (7) of this section, the maximum emissions outside of the frequency bands of operation shall be attenuated in accordance with the following limits:

- (a) For transmitters operating in the 5.15-5.25 GHz band: All emissions outside of the 5.15-5.35 GHz band shall not exceed an e.i.r.p. of  $-27$  dBm/MHz.
- (b) For transmitters operating in the 5.25-5.35 GHz band: All emissions outside of the 5.15-5.35 GHz band shall not exceed an e.i.r.p. of  $-27$  dBm/MHz.
- (c) For transmitters operating in the 5.47-5.725 GHz band: All emissions outside of the 5.47-5.725 GHz band shall not exceed an e.i.r.p. of  $-27$  dBm/MHz.
- (d) For transmitters operating in the 5.725-5.85 GHz band:
  - (i) All emissions shall be limited to a level of  $-27$  dBm/MHz at 75 MHz or more above or below the band edge increasing linearly to 10 dBm/MHz at 25 MHz above or below the band edge, and from 25 MHz above or below the band edge increasing linearly to a level of 15.6 dBm/MHz at 5 MHz above or below the band edge, and from 5 MHz above or below the band edge increasing linearly to a level of 27 dBm/MHz at the band edge.
  - (ii) Devices certified before March 2, 2017 with antenna gain greater than 10 dBi may demonstrate compliance with the emission limits in §15.247(d), but manufacturing, marketing and importing of devices certified under this alternative must cease by March 2, 2018. Devices certified before March 2, 2018 with antenna gain of 10 dBi or less may demonstrate compliance with the emission limits in §15.247(d), but manufacturing, marketing and importing of devices certified under this alternative must cease before March 2, 2020.
- (e) The emission measurements shall be performed using a minimum resolution bandwidth of 1 MHz. A lower resolution bandwidth may be employed near the band edge, when necessary, provided the measured energy is integrated to show the total power over 1 MHz.
- (f) Unwanted emissions below 1 GHz must comply with the general field strength limits set forth in §15.209. Further, any U-NII devices using an AC power line are required to comply also with the conducted limits set forth in §15.207.
- (g) The provisions of §15.205 apply to intentional radiators operating under this section.
- (h) When measuring the emission limits, the nominal carrier frequency shall be adjusted as close to the upper and lower frequency band edges as the design of the equipment permits.

### 6.6.2 Measuring Instruments :

Please refer to equipment list in this report.

### 6.6.3 Test Procedures

According to KDB789033 D02 General UNII Test Procedures New Rules v01 Section G: Unwanted Emission Measurement

#### 1. Unwanted Emissions in the Restricted Bands

- a) For all measurements, follow the requirements in section II.G.3. "General Requirements for Unwanted Emissions Measurements."
- b) At frequencies below 1000 MHz, use the procedure described in section II.G.4. "Procedure for Unwanted Emissions Measurements below 1000 MHz."
- c) At frequencies above 1000 MHz, measurements performed using the peak and average measurement procedures described in sections II.G.5. and II.G.6, respectively, must satisfy the respective peak and average limits. If all peak measurements satisfy the average limit, then average measurements are not required.
- d) For conducted measurements above 1000 MHz, EIRP shall be computed as specified in section II.G.3.b) and then field strength shall be computed as follows (see KDB Publication 412172):
  - i)  $E[\text{dB}\mu\text{V}/\text{m}] = \text{EIRP}[\text{dBm}] - 20 \log(d[\text{meters}]) + 104.77$ , where E = field strength and d = distance at which field strength limit is specified in the rules;
  - ii)  $E[\text{dB}\mu\text{V}/\text{m}] = \text{EIRP}[\text{dBm}] + 95.2$ , for d = 3 meters
- e) For conducted measurements below 1000 MHz, the field strength shall be computed as specified



in d), above, and then an additional 4.7 dB shall be added as an upper bound on the field strength that would be observed on a test range with a ground plane for frequencies between 30 MHz and 1000 MHz, or an additional 6 dB shall be added for frequencies below 30 MHz.

2. Unwanted Emissions that fall Outside of the Restricted Bands

- a) For all measurements, follow the requirements in section II.G.3. “General Requirements for Unwanted Emissions Measurements.”
- b) At frequencies below 1000 MHz, use the procedure described in section II.G.4. “Procedure for Unwanted Emissions Measurements below 1000 MHz.”
- c) At frequencies above 1000 MHz, use the procedure for maximum emissions described in section II.G.5., “Procedure for Unwanted Maximum Unwanted Emissions Measurements Above 1000 MHz.”
- d) Section 15.407(b) (1-3) specifies the unwanted emissions limit for the U-NII-1 and 2 bands. As specified, emissions above 1000 MHz that are outside of the restricted bands are subject to a peak emission limit of -27 dBm/MHz. However, an out-of-band emission that complies with both the average and peak limits of Section 15.209 is not required to satisfy the -27 dBm/MHz dBm/MHz peak emission limit.
  - i) Section 15.407(b) (4) specifies the unwanted emissions limit for the U-NII-3 band. A band emissions mask is specified in Section 15.407(b) (4) (i). An alternative to the band emissions mask is specified in Section 15.407(b) (4) (ii). The alternative limits are based on the highest antenna gain specified in the filing. There are also marketing and importation restrictions for the alternative limit.
- e) If radiated measurements are performed, field strength is then converted to EIRP as follows:
  - i)  $EIRP = (E \times d)^2 / 30$

Where:

- E is the field strength in V/m;
- d is the measurement distance in meters;
- EIRP is the equivalent isotropically radiated power in watts;
- ii) Working in dB units, the above equation is equivalent to:  
 $EIRP [dBm] = E [dB\mu V/m] + 20 \log (d [meters]) - 104.77$
- iii) Or, if d is 3 meters:  
 $EIRP [dBm] = E [dB\mu V/m] - 95.23$

3) Radiated versus Conducted Measurements.

The unwanted emission limits in both the restricted and non-restricted bands are based on radiated measurements; however, as an alternative, antenna-port conducted measurements in conjunction with cabinet emissions tests will be permitted to demonstrate compliance provided that the following steps are performed:

- (i) Cabinet emissions measurements. A radiated test shall be performed to ensure that cabinet emissions are below the emission limits. For the cabinet-emission measurements the antenna may be replaced by a termination matching the nominal impedance of the antenna.
- (ii) Impedance matching. Conducted tests shall be performed using equipment that matches the nominal impedance of the antenna assembly used with the EUT.
- (iii) EIRP calculation. A value representative of an upper bound on out-of-band antenna gain (in dBi) shall be added to the measured antenna-port conducted emission power to compute EIRP within the specified measurement bandwidth. (For emissions in the restricted bands, additional calculations are required to convert EIRP to field strength at the specified distance.) The upper bound on antenna gain for a device with a single RF output shall be selected as the maximum in-band gain of the antenna across all operating bands or 2 dBi, whichever is greater. However, for devices that operate in multiple bands using the same transmit antenna, the highest gain of the antenna within the operating band nearest to the out-of-band frequency being measured may be used in lieu of the overall highest gain when measuring emissions at frequencies within 20% of the absolute frequency at the nearest edge of that band, but in no case shall a value less than 2 dBi be selected.
- (iv) EIRP adjustments for multiple outputs. For devices with multiple outputs occupying the same or overlapping frequency ranges in the same band (e.g., MIMO or beamforming devices), compute the total EIRP as follows:

- Compute EIRP for each output, as described in (iii), above.
  - Follow the procedures specified in KDB Publication 662911 for summing emissions across the outputs or adjusting emission levels measured on individual outputs by  $10 \log(N_{ANT})$ , where  $N_{ANT}$  is the number of outputs.
  - Add the array gain term specified in KDB Publication 662911 for out-of-band and spurious signals.
    - (v) Direction of maximum emission.
- For all radiated emissions tests, measurements shall correspond to the direction of maximum emission level for each measured emission (see ANSI C63.10 for guidance).

### 6.6.4 Test Setup Layout

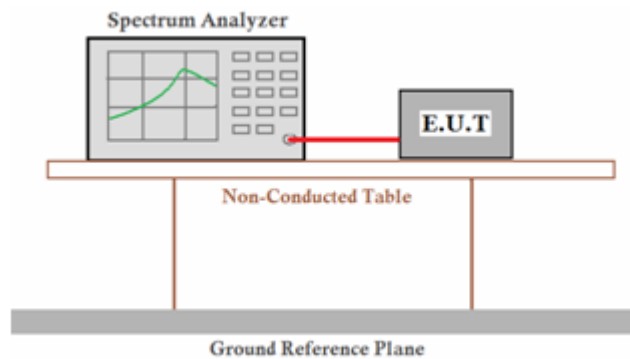

### 6.6.5 EUT Operation during Test

The EUT was programmed to be in continuously transmitting mode.

### 6.6.6 Test result

PASS

Please refer to Appendix D.5

Please refer to Appendix F.5

Please refer to Appendix G.5

Remark:

1. Measured Undesirable emission at difference data rate for each mode and recorded worst case for each mode;
2. Test results including cable loss;
3. Worst case data at 6Mbps at IEEE 802.11a; MCS0 at IEEE 802.11n HT20, IEEE 802.11n HT40, IEEE 802.11ac VHT80;
4. Covert Radiated E Level At 3m = Conducted average power + Directional Gain +  $104.77 - 20 \cdot \log(3)$ ;

## 6.8 Radiated Emissions Measurement

### 6.8.1 Standard requirement:

15.205 (a) Except as shown in paragraph (d) of this section, only spurious emissions are permitted in any of the frequency bands listed below:

MHz	MHz	MHz	GHz
0.090-0.110	16.42-16.423	399.9-410	4.5-5.15
\1\ 0.495-0.505	16.69475-16.69525	608-614	5.35-5.46
2.1735-2.1905	16.80425-16.80475	960-1240	7.25-7.75
4.125-4.128	25.5-25.67	1300-1427	8.025-8.5
4.17725-4.17775	37.5-38.25	1435-1626.5	9.0-9.2
4.20725-4.20775	73-74.6	1645.5-1646.5	9.3-9.5
6.215-6.218	74.8-75.2	1660-1710	10.6-12.7
6.26775-6.26825	108-121.94	1718.8-1722.2	13.25-13.4
6.31175-6.31225	123-138	2200-2300	14.47-14.5
8.291-8.294	149.9-150.05	2310-2390	15.35-16.2
8.362-8.366	156.52475-156.52525	2483.5-2500	17.7-21.4
8.37625-8.38675	156.7-156.9	2690-2900	22.01-23.12
8.41425-8.41475	162.0125-167.17	3260-3267	23.6-24.0
12.29-12.293.	167.72-173.2	3332-3339	31.2-31.8
12.51975-12.52025	240-285	3345.8-3358	36.43-36.5
12.57675-12.57725	322-335.4	3600-4400	(\2\)
13.36-13.41			

\1\ Until February 1, 1999, this restricted band shall be 0.490-0.510 MHz.

\2\ Above 38.6

According to §15.247 (d): 20dBc in any 100 kHz bandwidth outside the operating frequency band. In case the emission fall within the restricted band specified on 15.205(a), then the 15.209(a) limit in the table below has to be followed.

Frequencies (MHz)	Field Strength (microvolts/meter)	Measurement Distance (meters)
0.009~0.490	2400/F(KHz)	300
0.490~1.705	24000/F(KHz)	30
1.705~30.0	30	30
30~88	100	3
88~216	150	3
216~960	200	3
Above 960	500	3

### 6.8.2 Measuring Instruments and Setting:

Please refer to equipment list in this report. The following table is the setting of spectrum analyzer and receiver.

Spectrum Parameter	Setting
Attenuation	Auto
Start Frequency	1000 MHz
Stop Frequency	10 <sup>th</sup> carrier harmonic
RB / VB (Emission in restricted band)	1MHz / 1MHz for Peak, 1 MHz / 1/B kHz for Average
RB / VB (Emission in non-restricted band)	1MHz / 1MHz for Peak, 1 MHz / 1/B kHz for Average

Receiver Parameter	Setting
Attenuation	Auto
Start ~ Stop Frequency	9kHz~150kHz / RB/VB 200Hz/1KHz for QP/AVG
Start ~ Stop Frequency	150kHz~30MHz / RB/VB 9kHz/30KHz for QP/AVG
Start ~ Stop Frequency	30MHz~1000MHz / RB/VB 120kHz/1MHz for QP

### 6.8.3 Test Procedures

#### 1) Sequence of testing 9 kHz to 30 MHz

##### Setup:

- The equipment was set up to simulate a typical usage like described in the user manual or described by manufacturer.
- If the EUT is a tabletop system, a rotatable table with 0.8 m height is used.
- If the EUT is a floor standing device, it is placed on the ground.
- Auxiliary equipment and cables were positioned to simulate normal operation conditions.
- The AC power port of the EUT (if available) is connected to a power outlet below the turntable.
- The measurement distance is 3 meter.
- The EUT was set into operation.

##### Premeasurement:

- The turntable rotates from 0° to 315° using 45° steps.
- The antenna height is 1.5 meter.
- At each turntable position the analyzer sweeps with peak detection to find the maximum of all emissions

##### Final measurement:

- Identified emissions during the premeasurement the software maximizes by rotating the turntable position (0° to 360°) and by rotating the elevation axes (0° to 360°).
- The final measurement will be done in the position (turntable and elevation) causing the highest emissions with QPK detector.
- The final levels, frequency, measuring time, bandwidth, turntable position, correction factor, margin to the limit and limit will be recorded. Also a plot with the graph of the premeasurement and the limit will be stored.

## 2) Sequence of testing 30 MHz to 1 GHz

### Setup:

- The equipment was set up to simulate a typical usage like described in the user manual or described by manufacturer.
- If the EUT is a tabletop system, a table with 0.8 m height is used, which is placed on the ground plane.
- If the EUT is a floor standing device, it is placed on the ground plane with insulation between both.
- Auxiliary equipment and cables were positioned to simulate normal operation conditions
- The AC power port of the EUT (if available) is connected to a power outlet below the turntable.
- The measurement distance is 3 meter.
- The EUT was set into operation.

### Premeasurement:

- The turntable rotates from 0° to 315° using 45° steps.
- The antenna is polarized vertical and horizontal.
- The antenna height changes from 1 to 3 meter.
- At each turntable position, antenna polarization and height the analyzer sweeps three times in peak to find the maximum of all emissions.

### Final measurement:

- The final measurement will be performed with minimum the six highest peaks.
- According to the maximum antenna and turntable positions of premeasurement the software maximize the peaks by changing turntable position ( $\pm 45^\circ$ ) and antenna movement between 1 and 4 meter.
- The final measurement will be done with QP detector with an EMI receiver.
- The final levels, frequency, measuring time, bandwidth, antenna height, antenna polarization, turntable angle, correction factor, margin to the limit and limit will be recorded. Also a plot with the graph of the premeasurement with marked maximum final measurements and the limit will be stored.

### 3) Sequence of testing 1 GHz to 18 GHz

#### Setup:

- The equipment was set up to simulate a typical usage like described in the user manual or described by manufacturer.
- If the EUT is a tabletop system, a rotatable table with 1.5 m height is used.
- If the EUT is a floor standing device, it is placed on the ground plane with insulation between both.
- Auxiliary equipment and cables were positioned to simulate normal operation conditions
- The AC power port of the EUT (if available) is connected to a power outlet below the turntable.
- The measurement distance is 3 meter.
- The EUT was set into operation.

#### Premeasurement:

- The turntable rotates from 0° to 315° using 45° steps.
- The antenna is polarized vertical and horizontal.
- The antenna height scan range is 1 meter to 2.5 meter.
- At each turntable position and antenna polarization the analyzer sweeps with peak detection to find the maximum of all emissions.

#### Final measurement:

- The final measurement will be performed with minimum the six highest peaks.
- According to the maximum antenna and turntable positions of premeasurement the software maximize the peaks by changing turntable position ( $\pm 45^\circ$ ) and antenna movement between 1 and 4 meter. This procedure is repeated for both antenna polarizations.
- The final measurement will be done in the position (turntable, EUT-table and antenna polarization) causing the highest emissions with Peak and Average detector.
- The final levels, frequency, measuring time, bandwidth, turntable position, EUT-table position, antenna polarization, correction factor, margin to the limit and limit will be recorded. Also a plot with the graph of the premeasurement with marked maximum final measurements and the limit will be stored.

#### 4) Sequence of testing above 18 GHz

##### Setup:

- The equipment was set up to simulate a typical usage like described in the user manual or described by manufacturer.
- If the EUT is a tabletop system, a rotatable table with 1.5 m height is used.
- If the EUT is a floor standing device, it is placed on the ground plane with insulation between both.
- Auxiliary equipment and cables were positioned to simulate normal operation conditions
- The AC power port of the EUT (if available) is connected to a power outlet below the turntable.
- The measurement distance is 1 meter.
- The EUT was set into operation.

##### Premeasurement:

- The antenna is moved spherical over the EUT in different polarisations of the antenna.

##### Final measurement:

- The final measurement will be performed at the position and antenna orientation for all detected emissions that were found during the premeasurements with Peak and Average detector.
- The final levels, frequency, measuring time, bandwidth, correction factor, margin to the limit and limit will be recorded. Also a plot with the graph of the premeasurement and the limit will be stored.

#### 6.8.4 Test Setup Layout

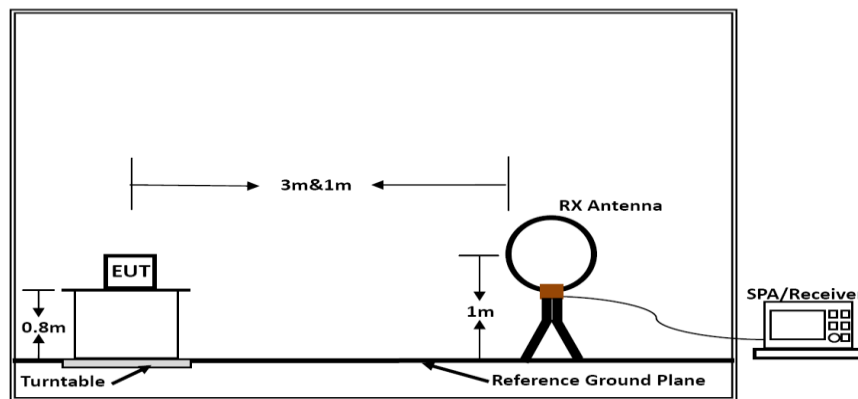

Below 30MHz

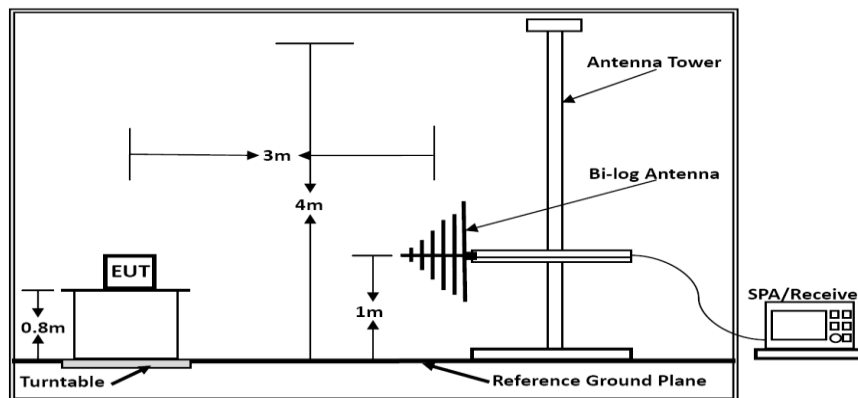

Below 1GHz

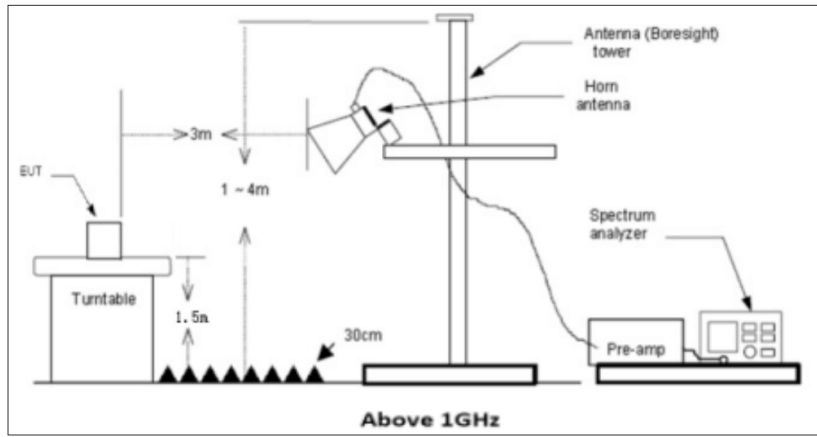

Above 18 GHz shall be extrapolated to the specified distance using an extrapolation factor of 20 dB/decade from 3m to 1m.

Distance extrapolation factor =  $20 \log(\text{specific distance [3m]} / \text{test distance [1m]})$  (dB);

Limit line = specific limits (dBuV) + distance extrapolation factor [6 dB].

### 6.8.5 EUT Operation during Test

The EUT was programmed to be in continuously transmitting mode.

### 6.8.6 Test result

Temperature	25.2°C	Humidity	51.2%
Test Engineer	Simba Huang	Configurations	IEEE 802.11a/n/ac

Remarks:

1. Only the worst case Main Antenna test data.
2. Pre-scan all kind of the place mode (X-axis, Y-axis, Z-axis), and found the Y-axis which it is worse case.

### ■ Results of Radiated Emissions (9 KHz~30MHz)

Freq. (MHz)	Level (dBuV)	Over Limit (dB)	Over Limit (dBuV)	Remark
-	-	-	-	See Note

Note:

The emission from 9 kHz to 30MHz was pre-tested and found the result was 20dB lower than the limit, and the permissible value has no need to be reported.

Distance extrapolation factor =  $40 \log(\text{specific distance} / \text{test distance})$  (dB);

Limit line = specific limits (dBuV) + distance extrapolation factor.



■ Results of Radiated Emissions (30MHz~1GHz)

Pre-scan all modes and recorded the worst case results in this report (IEEE 802.11ac VHT20)..

Model name:	MEEBOOK M7	Test Date :	2023-06-16
Polarization :	Vertical	Test Result:	<input checked="" type="checkbox"/> Pass <input type="checkbox"/> Fail

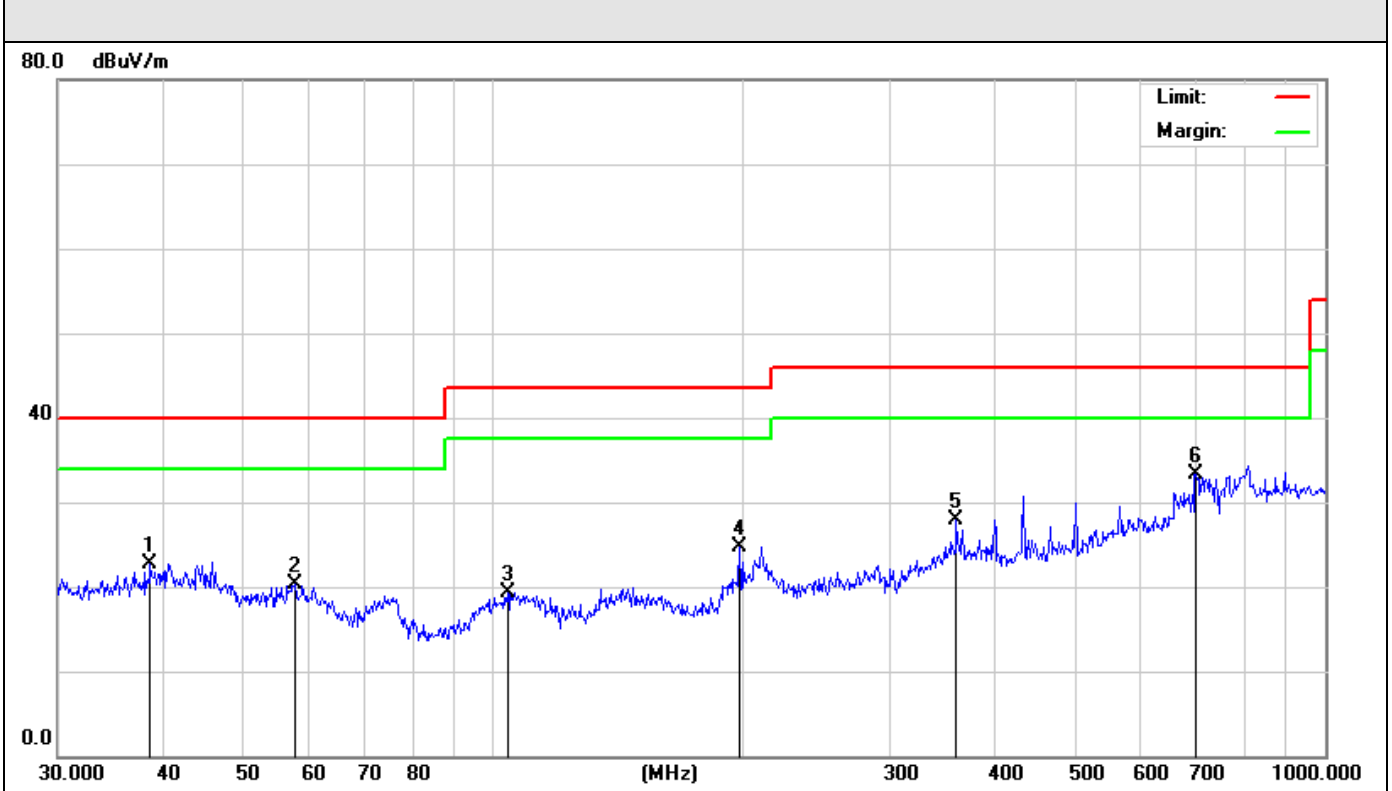

Remark: Factor = Antenna Factor + Cable Loss – Pre-amplifier.  
 Measurement Result=Reading Level +Correct Factor;  
 Over Limit= Measurement Result- Limit;

No.	Mk.	Freq. MHz	Reading Level dBuV	Correct Factor dB	Measure- ment dBuV/m	Limit dBuV/m	Over dB	Detector
1		38.7518	21.11	1.52	22.63	40.00	-17.37	QP
2		57.7962	21.57	-1.22	20.35	40.00	-19.65	QP
3		104.1701	21.47	-2.07	19.40	43.50	-24.10	QP
4		197.8928	25.62	-0.83	24.79	43.50	-18.71	QP
5		360.4476	22.44	5.54	27.98	46.00	-18.02	QP
6	*	699.3046	24.14	9.26	33.40	46.00	-12.60	QP

Model name:	MEEBOOK M7	Test Date :	2023-06-16
Polarization :	Horizontal	Test Result:	<input checked="" type="checkbox"/> Pass <input type="checkbox"/> Fail

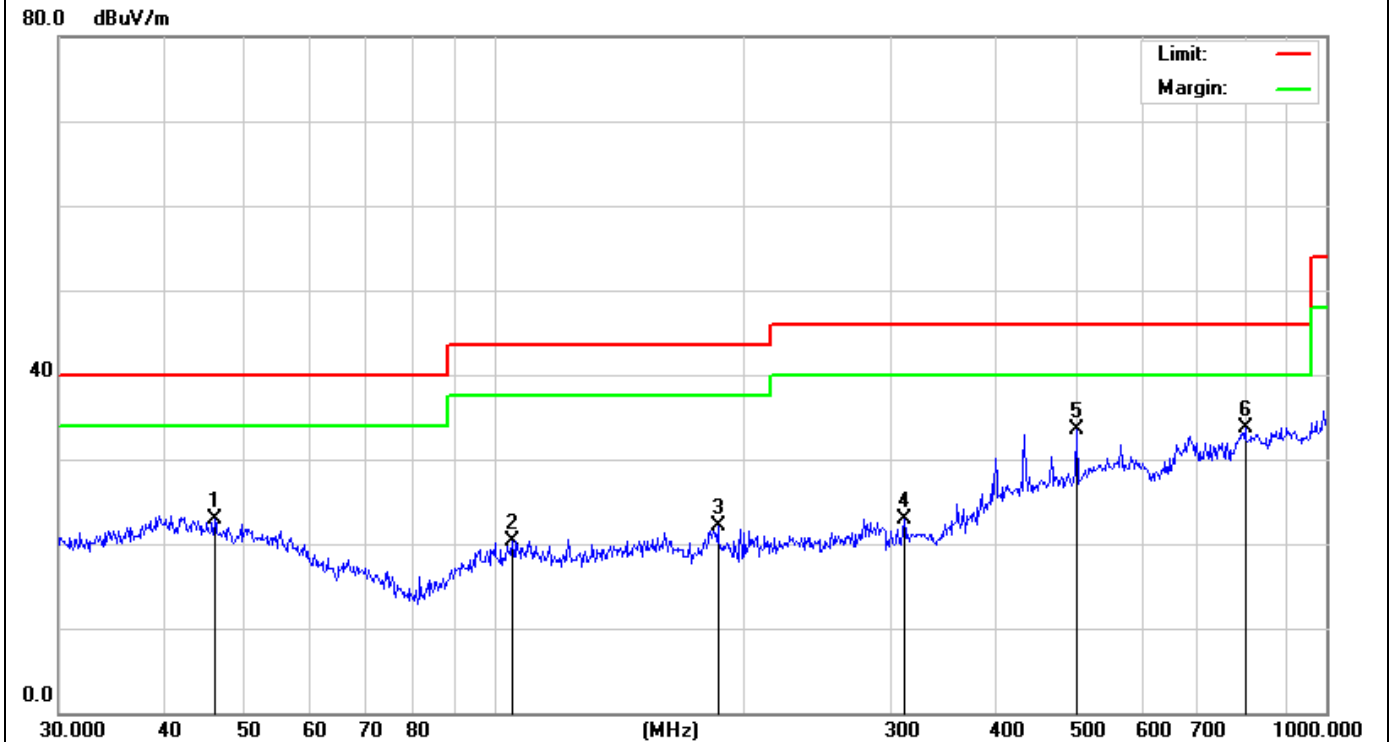

Remark: Factor = Antenna Factor + Cable Loss – Pre-amplifier.  
 Measurement Result=Reading Level +Correct Factor;  
 Over Limit= Measurement Result- Limit;

No.	Mk.	Freq. MHz	Reading Level dBuV	Correct Factor dB	Measure- ment dBuV/m	Limit dBuV/m	Over dB	Detector
1		46.1779	19.57	3.40	22.97	40.00	-17.03	QP
2		105.2718	21.73	-1.33	20.40	43.50	-23.10	QP
3		185.7882	22.48	-0.39	22.09	43.50	-21.41	QP
4		311.0867	21.16	1.73	22.89	46.00	-23.11	QP
5		501.1790	25.01	8.44	33.45	46.00	-12.55	QP
6	*	798.9797	21.23	12.54	33.77	46.00	-12.23	QP

**Results for Radiated Emissions (1- 40 GHz)**

*Note: All the modes have been tested and recorded worst mode in the report.*

*IEEE 802.11a*

*Channel 36 / 5180 MHz*

Freq GHz	Read Level dBuV	Correct Factor	Measured Level dBuV	Limit Line dBuV/m	Over limit dB	Remark	Pol/Phase
10360	33.76	12.56	45.97	68.20	-22.23	Peak	Horizontal
15540	20.11	16.45	36.51	54.00	-17.49	Average	Horizontal
10360	32.81	12.56	44.64	68.20	-23.56	Peak	Vertical
15540	20.38	16.45	36.32	54.00	-17.68	Average	Vertical

*Channel 48 / 5240 MHz*

Freq GHz	Read Level dBuV	Correct Factor	Measured Level dBuV	Limit Line dBuV/m	Over limit dB	Remark	Pol/Phase
10480	34.30	12.68	46.74	68.20	-21.46	Peak	Horizontal
15720	21.35	16.54	36.95	54.00	-17.05	Average	Horizontal
10480	31.65	12.68	44.01	68.20	-24.19	Peak	Vertical
15720	19.94	16.54	36.12	54.00	-17.88	Average	Vertical

*Channel 64 / 5320 MHz*

Freq GHz	Read Level dBuV	Correct Factor	Measured Level dBuV	Limit Line dBuV/m	Over limit dB	Remark	Pol/Phase
10640	32.27	13.81	45.55	68.20	-22.65	Peak	Horizontal
15960	20.54	16.46	36.72	54.00	-17.28	Average	Horizontal
10640	31.90	13.81	45.34	68.20	-22.86	Peak	Vertical
15960	21.11	16.46	36.88	54.00	-17.12	Average	Vertical

*Channel 100 / 5500 MHz*

Freq GHz	Read Level dBuV	Correct Factor	Measured Level dBuV	Limit Line dBuV/m	Over limit dB	Remark	Pol/Phase
11000	30.18	16.80	46.27	68.20	-21.93	Peak	Horizontal
16500	18.56	15.82	33.88	54.00	-20.12	Average	Horizontal
11000	27.64	16.80	44.15	68.20	-24.05	Peak	Vertical
16500	18.99	15.82	34.48	54.00	-19.52	Average	Vertical

*Channel 140 / 5700 MHz*

Freq GHz	Read Level dBuV	Correct Factor	Measured Level dBuV	Limit Line dBuV/m	Over limit dB	Remark	Pol/Phase
11400	30.59	17.04	47.10	68.20	-21.10	Peak	Horizontal
17100	18.52	21.31	39.55	54.00	-14.45	Average	Horizontal
11400	28.72	17.04	45.39	68.20	-22.81	Peak	Vertical
17100	19.38	21.31	40.00	54.00	-14.00	Average	Vertical

IEEE 802.11n HT40

Channel 38 / 5190 MHz

Freq GHz	Read Level dBuV	Correct Factor	Measured Level dBuV	Limit Line dBuV/m	Over limit dB	Remark	Pol/Phase
10380	29.73	12.58	41.99	68.20	-26.21	29.73	Horizontal
15570	19.88	16.48	36.00	54.00	-18.00	19.88	Horizontal
10380	28.46	12.58	40.91	68.20	-27.29	28.46	Vertical
15570	19.79	16.48	36.22	54.00	-17.78	19.79	Vertical

Channel 62 / 5310 MHz

Freq GHz	Read Level dBuV	Correct Factor	Measured Level dBuV	Limit Line dBuV/m	Over limit dB	Remark	Pol/Phase
10620	29.49	13.65	43.01	68.20	-25.19	Peak	Horizontal
15930	20.10	16.53	36.58	54.00	-17.42	Average	Horizontal
10620	28.92	13.65	41.87	68.20	-26.33	Peak	Vertical
15930	20.13	16.53	35.96	54.00	-18.04	Average	Vertical

Channel 102 / 5510 MHz

Freq GHz	Read Level dBuV	Correct Factor	Measured Level dBuV	Limit Line dBuV/m	Over limit dB	Remark	Pol/Phase
11020	29.23	16.83	45.36	68.20	-22.84	Peak	Horizontal
16530	20.11	16.10	35.51	54.00	-18.49	Average	Horizontal
11020	28.22	16.83	44.30	68.20	-23.90	Peak	Vertical
16530	20.18	16.10	35.75	54.00	-18.25	Average	Vertical

Channel 134 / 5670 MHz

Freq GHz	Read Level dBuV	Correct Factor	Measured Level dBuV	Limit Line dBuV/m	Over limit dB	Remark	Pol/Phase
11340	29.75	17.03	46.08	68.20	-22.12	Peak	Horizontal
17010	19.38	20.57	39.20	54.00	-14.80	Average	Horizontal
11340	28.12	17.03	44.62	68.20	-23.58	Peak	Vertical
17010	18.42	20.57	38.71	54.00	-15.29	Average	Vertical

IEEE 802.11ac VHT80

Channel 42 / 5210 MHz

Freq GHz	Read Level dBuV	Correct Factor	Measured Level dBuV	Limit Line dBuV/m	Over limit dB	Remark	Pol/Phase
10420	27.57	12.62	40.14	68.20	-28.06	Peak	Horizontal
15630	18.09	16.52	33.88	54.00	-20.12	Average	Horizontal
10420	27.04	12.62	39.15	68.20	-29.05	Peak	Vertical
15630	17.76	16.52	34.26	54.00	-19.74	Average	Vertical

Channel 106 / 5530 MHz

Freq GHz	Read Level dBuV	Correct Factor	Measured Level dBuV	Limit Line dBuV/m	Over limit dB	Remark	Pol/Phase
11060	27.65	16.89	44.30	68.20	-23.90	Peak	Horizontal
16590	19.27	16.67	35.00	54.00	-19.00	Average	Horizontal
11060	27.30	16.89	43.87	68.20	-24.33	Peak	Vertical
16590	18.21	16.67	34.52	54.00	-19.48	Average	Vertical

Channel 122 / 5610 MHz

Freq GHz	Read Level dBuV	Correct Factor	Measured Level dBuV	Limit Line dBuV/m	Over limit dB	Remark	Pol/Phase
11220	27.81	16.99	44.48	68.20	-23.72	Peak	Horizontal
16830	18.89	18.92	37.45	54.00	-16.55	Average	Horizontal
11220	26.60	16.99	43.46	68.20	-24.74	Peak	Vertical
16830	18.07	18.92	36.94	54.00	-17.06	Average	Vertical

Notes:

- 1). Measuring frequencies from 9 KHz ~ 40GHz, No emission found between lowest internal used/generated frequency to 30MHz.
- 2). Radiated emissions measured in frequency range from 9 KHz ~ 40GHz were made with an instrument using Peak detector mode.
- 3). 18~40GHz at least have 20dB margin. No recording in the test report.
- 4). Worst case data at 6Mbps at IEEE 802.11a; MCS0 at IEEE 802.11n HT20, IEEE 802.11n HT40, IEEE 802.11ac VHT80;
- 5). Data of measurement within this frequency range shown “---” in the table above means the reading of emissions are attenuated more than 20dB below the permissible limits or the field strength is too small to be measured.
- 6). Margin=Reading level + Factor - Limit

## 6.9 Power Line Conducted Emissions

### 6.9.1 Standard requirement:

According to §15.207 (a): For an intentional radiator which is designed to be connected to the public utility (AC) power line, the radio frequency voltage that is conducted back onto the AC power line on any frequency or frequencies within the band 150 kHz to 30 MHz shall not exceed 250 microvolts (The limit decreases linearly with the logarithm of the frequency in the range 0.15 MHz to 0.50 MHz). The limits at specific frequency range is listed as follows:

Frequency Range (MHz)	Limits (dB $\mu$ V)	
	Quasi-peak	Average
0.15 to 0.50	66 to 56	56 to 46
0.50 to 5	56	46
5 to 30	60	50

\* Decreasing linearly with the logarithm of the frequency

### 6.9.2 Test Setup Layout

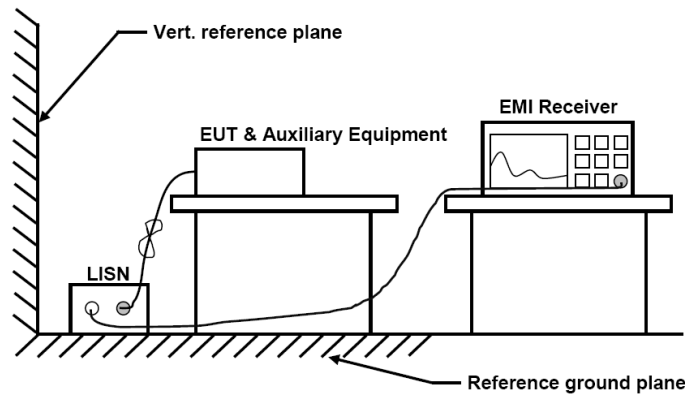

### 6.9.3 Test Procedures

The transmitter output is connected to EMI receiver. The resolution bandwidth is set to 9 kHz. The video bandwidth is set to 30 kHz, Sweep time=Auto

The spectrum from 150 kHz to 30MHz is investigated with the transmitter set to the lowest, middle, and highest channels.

### 6.9.4 EUT Operation during Test

The EUT was programmed to be in continuously transmitting mode.

### 6.9.5 Test result

PASS

The test data please refer to following page.

**Measurement data:**

**AC Conducted Emission of charge from PC mode @ AC 120V/60Hz @ (IEEE 802.11n HT20) (worst case)**

Model name:	MEEBOOK M7	Test Date :	2023-06-16
Temperature:	24.6° C	Relative Humidity:	52.4%
ATM Pressure:	101 kPa	Test by:	Simba Huang
Phase :	Line	Test Result:	<input checked="" type="checkbox"/> Pass <input type="checkbox"/> Fail

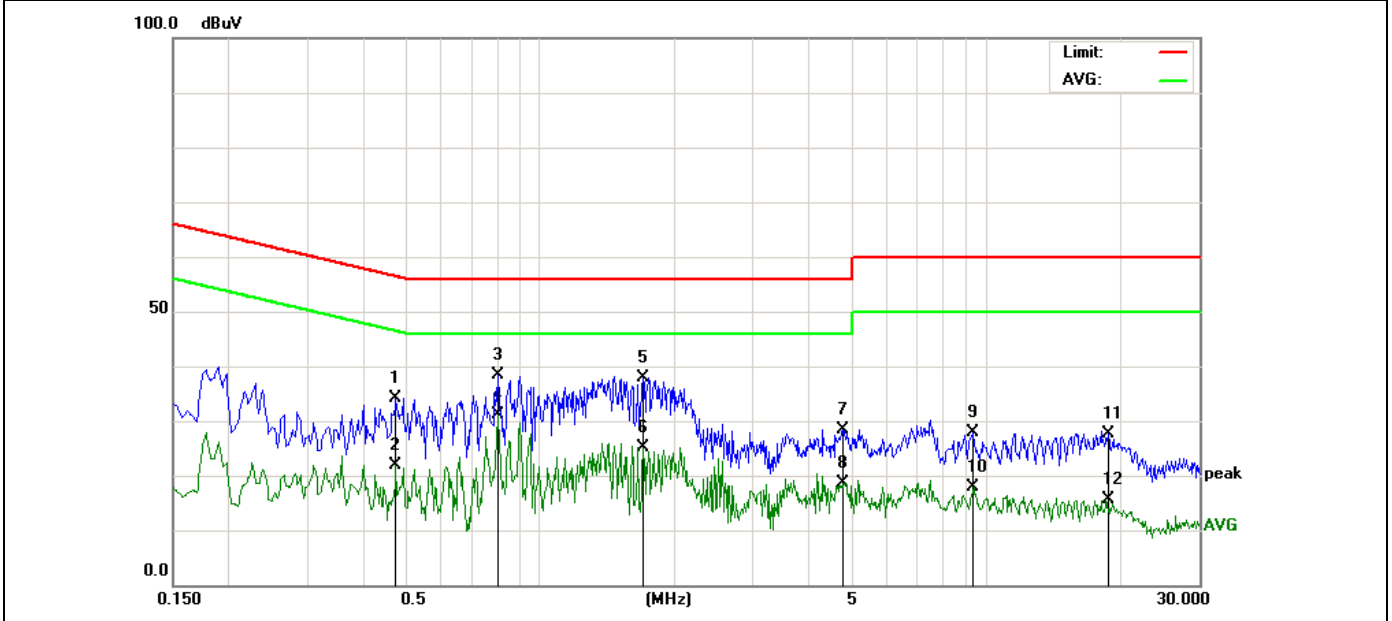

Remark: Factor = Antenna Factor + Cable Loss – Pre-amplifier.  
 Measurement Result=Reading Level +Correct Factor;  
 Over Limit= Measurement Result- Limit;

No. Mk.	Freq. MHz	Reading Level dBuV	Correct Factor dB	Measurement dBuV	Limit dBuV	Over dB	Detector
1	0.4740	24.14	10.01	34.15	56.44	-22.29	QP
2	0.4740	11.93	10.01	21.94	46.44	-24.50	AVG
3	0.8020	28.33	9.93	38.26	56.00	-17.74	QP
4 *	0.8020	21.22	9.93	31.15	46.00	-14.85	AVG
5	1.7060	27.84	9.94	37.78	56.00	-18.22	QP
6	1.7060	15.21	9.94	25.15	46.00	-20.85	AVG
7	4.7660	18.34	10.04	28.38	56.00	-27.62	QP
8	4.7660	8.59	10.04	18.63	46.00	-27.37	AVG
9	9.3139	17.72	10.10	27.82	60.00	-32.18	QP
10	9.3139	7.69	10.10	17.79	50.00	-32.21	AVG
11	18.7260	16.98	10.61	27.59	60.00	-32.41	QP
12	18.7260	5.02	10.61	15.63	50.00	-34.37	AVG



Model name:	MEEBOOK M7	Test Date :	2023-06-16
Temperature:	25.2° C	Relative Humidity:	51.1%
ATM Pressure:	101 kPa	Test by:	Simba Huang
Phase :	Neutral	Test Result:	<input checked="" type="checkbox"/> Pass <input type="checkbox"/> Fail

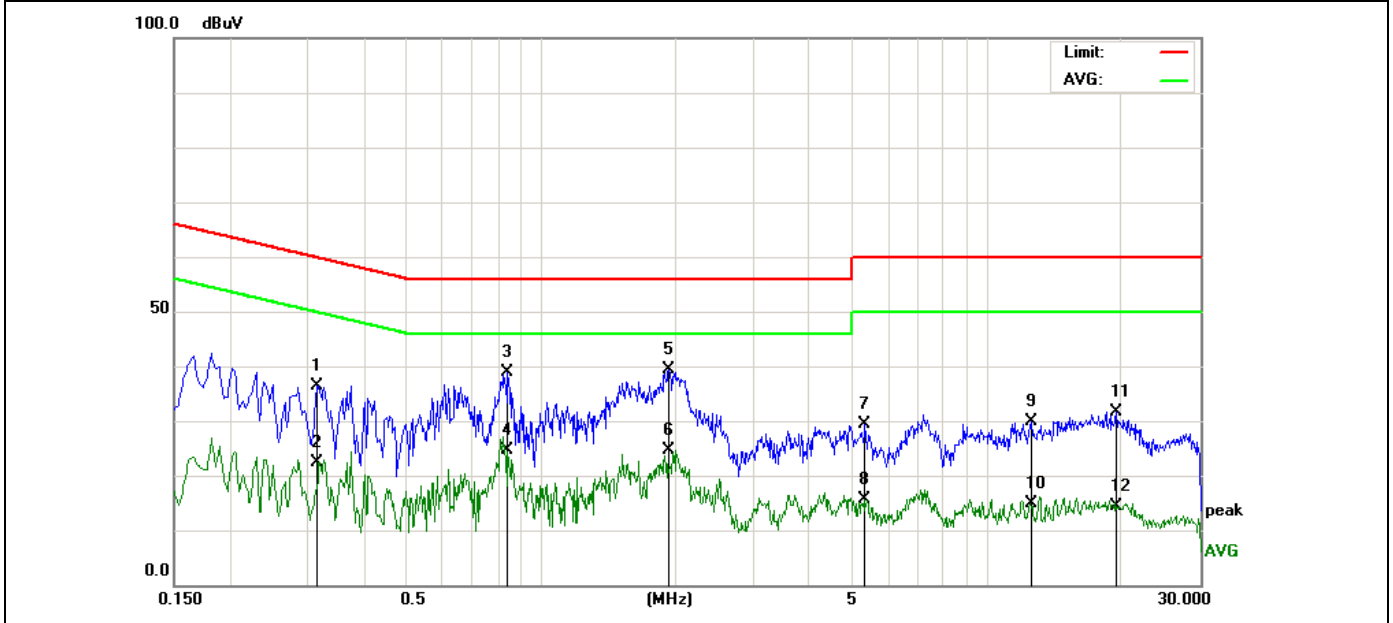

Remark: Factor = Antenna Factor + Cable Loss – Pre-amplifier.  
 Measurement Result=Reading Level +Correct Factor;  
 Over Limit= Measurement Result- Limit;

No. Mk.	Freq. MHz	Reading Level dBuV	Correct Factor dB	Measurement dBuV	Limit dBuV	Over dB	Detector
1	0.3140	26.18	10.20	36.38	59.86	-23.48	QP
2	0.3140	12.25	10.20	22.45	49.86	-27.41	AVG
3	0.8420	28.85	9.96	38.81	56.00	-17.19	QP
4	0.8420	14.68	9.96	24.64	46.00	-21.36	AVG
5 *	1.9380	29.27	9.99	39.26	56.00	-16.74	QP
6	1.9380	14.63	9.99	24.62	46.00	-21.38	AVG
7	5.3100	19.33	10.12	29.45	60.00	-30.55	QP
8	5.3100	5.44	10.12	15.56	50.00	-34.44	AVG
9	12.5740	19.47	10.35	29.82	60.00	-30.18	QP
10	12.5740	4.47	10.35	14.82	50.00	-35.18	AVG
11	19.4300	20.68	11.01	31.69	60.00	-28.31	QP
12	19.4300	3.49	11.01	14.50	50.00	-35.50	AVG

Notes:

1. Pre-scan all modes and recorded the worst case results in this report (IEEE 802.11n HT20 mode (HCH)).
2. An initial pre-scan was performed on the line and neutral lines with peak detector.
3. Quasi-Peak and Average measurement were performed at the frequencies with maximized peak emission.
4. Final Level =Receiver Read level + LISN Factor + Cable Loss
5. If the average limit is met when using a quasi-peak detector receiver, the EUT shall be deemed to meet both limits and measurement with the average detector receiver is unnecessary.

## 6.10 Frequency Stability

### 6.10.1 Standard requirement:

According to FCC §15.407(g) “Manufacturers of U-NII devices are responsible for ensuring frequency stability such that an emission is maintained within the band of operation under all conditions of normal operation as specified in the users manual.”

According to FCC §2.1055(a) “The frequency stability shall be measured with variation of ambient temperature as follows:”

- (1) From  $-30^{\circ}$  to  $+50^{\circ}$  centigrade for all equipment except that specified in paragraphs (a) (2) and (3) of this section.
- (2) From  $-20^{\circ}$  to  $+50^{\circ}$  centigrade for equipment to be licensed for use in the Maritime Services under part 80 of this chapter, except for Class A, B, and S Emergency Position Indicating Radiobeacons (EPIRBS), and equipment to be licensed for use above 952 MHz at operational fixed stations in all services, stations in the Local Television Transmission Service and Point-to-Point Microwave Radio Service under part 21 of this chapter, equipment licensed for use aboard aircraft in the Aviation Services under part 87 of this chapter, and equipment authorized for use in the Family Radio Service under part 95 of this chapter.

From  $0^{\circ}$  to  $+50^{\circ}$  centigrade for equipment to be licensed for use in the Radio Broadcast Services under part 73 of this chapter.

### 6.10.2 Measuring Instruments and Setting:

Please refer to equipment list in this report.

### 6.10.3 Test Procedures

The equipment under test was connected to an external AC or DC power supply and input rated voltage. RF output was connected to a frequency counter or spectrum analyzer via feed through attenuators. The EUT was placed inside the temperature chamber. Set the spectrum analyzer RBW low enough to obtain the desired frequency resolution and measure EUT 20 degree operating frequency as reference frequency. Turn EUT off and set the chamber temperature to -30 degree. After the temperature stabilized for approximately 30 minutes recorded the frequency. Repeat step measure with 10 degree increased per stage until the highest temperature of +50 degree reached.

### 6.10.4 Test Setup Layout

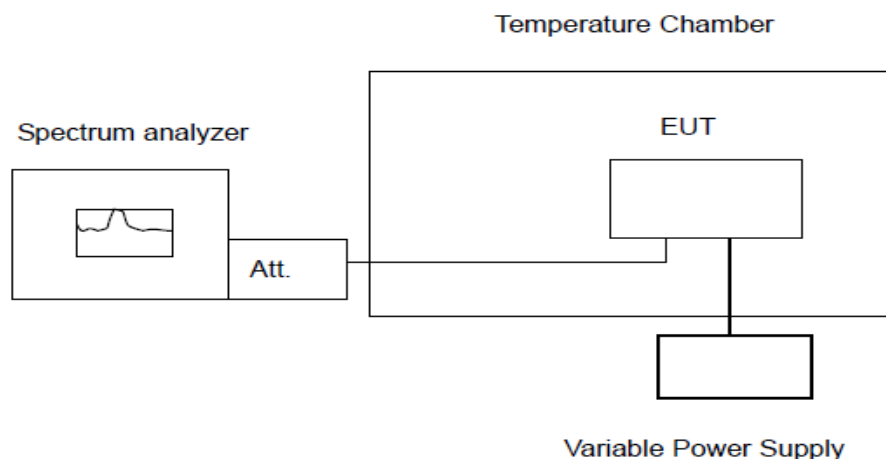

### 6.10.5 EUT Operation during Test

The EUT was programmed to be in continuously transmitting mode.

### 6.10.6 Test result

PASS

**Please refer to Appendix D.6**

*Remark:*

1. *Measured all conditions and recorded worst case.*

## **7 Test Setup Photographs of EUT**

Please refer to separated files for Test Setup Photos of the EUT.

## **8 External Photographs of EUT**

Please refer to separated files for External Photos of the EUT.

## **9 Internal Photographs of EUT**

Please refer to separated files for Internal Photos of the EUT.

-----End-----