

FCC RADIO TEST REPORT

FCC ID:2A53E-M6

Product: E-book reader

Trade Mark: MEEBOOK

Model No.: M6

Family Model: M6A, M6B, S6, S6H

Report No.: S23020703210004

Issue Date: Feb 27, 2023

Prepared for

Shenzhen Haoqing Technology Co., LTD
Room 405, Zongtai Future City, No. 2007, Baoyuan Road, Xixiang, Bao'an District,
Shenzhen, China

Prepared by

Shenzhen NTEK Testing Technology Co., Ltd.
1/F, Building E, Fenda Science Park, Sanwei Community,
Xixiang Street Bao'an District, Shenzhen 518126 P.R. China
Tel. 400-800-6106, 0755-2320 0050, 0755-2320 0090
Website: <http://www.ntek.org.cn>

TEST RESULT CERTIFICATION

Applicant's name : Shenzhen Haoqing Technology Co., LTD
Address : Room 405, Zongtai Future City, No. 2007, Baoyuan Road, Xixiang, Bao'an District, Shenzhen, China

Manufacturer's Name : Shenzhen Haoqing Technology Co., LTD
Address : Room 405, Zongtai Future City, No. 2007, Baoyuan Road, Xixiang, Bao'an District, Shenzhen, China

Product description

Product name : E-book reader
Model and/or type reference : M6
Family Model : M6A, M6B, S6, S6H

Standards : FCC Part15.407

Test procedure : ANSI C63.10-2013 and KDB 789033 D02 General UNII Test Procedures New Rules v02r01
FCC KDB 662911 D01 Multiple Transmitter Output v02r01
KDB 905462 D03 Client Without DFS New Rules v01r02
KDB 905462 D02 UNII DFS Compliance Procedures New Rules v02

This device described above has been tested by NTEK, and the test results show that the equipment under test (EUT) is in compliance with the FCC requirements. And it is applicable only to the tested sample identified in the report.

This report shall not be reproduced except in full, without the written approval of NTEK, this document may be altered or revised by NTEK, personnel only, and shall be noted in the revision of the document.

Test Sample Number : S230207032003

Date of Test

Date (s) of performance of tests : Feb 09, 2023 ~ Feb 25, 2023

Date of Issue : Feb 27, 2023

Test Result : Pass

Testing Engineer : [Signature]
(Allen Liu)

Authorized Signatory : [Signature]
(Alex Li)

Table of Contents

	Page
1. SUMMARY OF TEST RESULTS	7
1.1 FACILITIES AND ACCREDITATIONS	8
1.2 MEASUREMENT UNCERTAINTY	8
1 . GENERAL INFORMATION	9
1.1 GENERAL DESCRIPTION OF EUT	9
1.2 DESCRIPTION OF TEST MODES	11
1.3 BLOCK DIGRAM SHOWING THE CONFIGURATION OF SYSTEM TESTED	12
1.4 DESCRIPTION OF SUPPORT UNITS(CONDUCTED MODE)	13
1.5 EQUIPMENTS LIST FOR ALL TEST ITEMS	14
2 . EMC EMISSION TEST	16
2.1 CONDUCTED EMISSION MEASUREMENT	16
2.1.1 APPLICABLE STANDARD	16
2.1.2 CONFORMANCE LIMIT	16
2.1.3 TEST CONFIGURATION	16
2.1.4 TEST PROCEDURE	16
2.2 RADIATED EMISSION MEASUREMENT	25
2.2.1 APPLICABLE STANDARD	25
2.2.2 CONFORMANCE LIMIT	25
2.2.3 MEASURING INSTRUMENTS	25
2.2.4 TEST CONFIGURATION	26
2.2.5 TEST PROCEDURE	27
2.2.6 TEST RESULTS (9KHZ – 30 MHZ)	28
2.2.7 TEST RESULTS (30MHZ – 1GHZ)	29
2.2.8 TEST RESULTS (1GHZ-18GHZ)	37
2.2.10 TEST RESULTS (18GHZ-40GHZ)	45
3 . POWER SPECTRAL DENSITY TEST	56
3.1 APPLIED PROCEDURES / LIMIT	56
3.2 TEST PROCEDURE	57
3.3 DEVIATION FROM STANDARD	57
3.4 TEST SETUP	57
3.5 EUT OPERATION CONDITIONS	57
3.6 TEST RESULTS	58
4 . 26DB & 99% EMISSION BANDWIDTH	59
4.1 APPLIED PROCEDURES / LIMIT	59
4.2 TEST PROCEDURE	59
4.3 EUT OPERATION CONDITIONS	60
4.4 TEST RESULTS	60

Table of Contents

	Page
5 . MINIMUM 6 DB BANDWIDTH	61
5.1 APPLIED PROCEDURES / LIMIT	61
5.2 TEST PROCEDURE	61
5.3 DEVIATION FROM STANDARD	61
5.4 TEST SETUP	61
5.5 EUT OPERATION CONDITIONS	61
5.6 TEST RESULTS	62
6 . MAXIMUM CONDUCTED OUTPUT POWER	63
6.1 PPLIED PROCEDURES / LIMIT	63
6.2 TEST RESULTS	65
7 . OUT OF BAND EMISSIONS	66
7.1 APPLICABLE STANDARD	66
7.2 TEST PROCEDURE	66
7.3 DEVIATION FROM STANDARD	67
7.4 TEST SETUP	67
7.5 EUT OPERATION CONDITIONS	67
7.6 TEST RESULTS	68
8. FREQUENCY STABILITY MEASUREMENT	69
8.1 LIMIT	69
8.2 TEST PROCEDURES	69
8.3 TEST SETUP LAYOUT	69
8.4 EUT OPERATION DURING TEST	69
8.5 TEST RESULTS	70
9. DYNAMIC FREQUENCY SELECTION(DFS)	82
9.1 APPLICABILITY OF DFS REQUIREMENTS	82
9.2 INTERFERENCE THRESHOLD VALUES, MASTER OR CLIENT INCORPORATING IN-SERVICE MONITORING	82
9.3 DFS RESPONSE REQUIREMENT VALUES	83
9.4 SHORT PULSE RADAR TEST WAVEFORMS	83
9.5 CALIBRATION SETUP AND DFS TEST RESULTS	84
9.6 CONDUCTED CALIBRATION SETUP	84
9.7 RADAR WAVEFORM CALIBRATION RESULT	85
9.8 IN-SERVICE MONITORING: CHANNEL MOVE TIME, CHANNEL CLOSING TRANSMISSION TIME AND NON-OCCUPANCY PERIOD	86
9.9 RESULT OF CHANNEL MOVE TIME, CHANNEL CLOSING TRANSMISSION TIME AND NON-OCCUPANCY PERIOD FOR CLIENT BEACON TEST	87

Table of Contents

	Page
TEST DATA REFERENCE ATTACHMENT.	87
9. ANTENNA REQUIREMENT	88
9.1 STANDARD REQUIREMENT	88
9.2 EUT ANTENNA	88

Revision History

Report No.	Version	Description	Issued Date
S23020703210004	Rev.01	Initial issue of report	Feb 27, 2023

1. SUMMARY OF TEST RESULTS

Test procedures according to the technical standards:

FCC Part15 (15.407) , Subpart E			
Standard Section	Test Item	Judgment	Remark
15.207	AC Power Line Conducted Emissions	PASS	
15.209(a), 15.407 (b)(1) 15.407 (b)(2) 15.407 (b)(3) 15.407 (b)(4) 15.407(b)(8)(9)	Spurious Radiated Emissions	PASS	
15.407 (a)	26 dB and 99% Emission Bandwidth	PASS	
15.407(e)	Minimum 6 dB bandwidth	PASS	
15.407 (a)	Maximum Conducted Output Power	PASS	
15.407 (b)(1) 15.407 (b)(2) 15.407 (b)(3) 15.407 (b)(4)	Band Edge	PASS	
15.407 (a)	Power Spectral Density	PASS	
15.407(b)	Spurious Emissions at Antenna Terminals	PASS	
15.407(g)	Frequency Stability Measurement	PASS	
15.407(h)	Dynamic Frequency Selection(DFS)	PASS	
15.203	Antenna Requirement	PASS	
15.407(c)	Automatically discontinue transmission	PASS	(Note 3)

NOTE:

- (1) "N/A" denotes test is not applicable in this Test Report
- (2) This device operates with a duty cycle greater than 99%
- (3) The product is a client device, and the data transmission is limited by the AP. When the information to be sent is missing or the operation fails, the device will automatically stop sending and directly connect to the AP correctly again.

1.1 FACILITIES AND ACCREDITATIONS

FACILITIES

All measurement facilities used to collect the measurement data are located at
 1/F, Building E, Fenda Science Park Sanwei, Xixiang, Bao'an District
 Shenzhen, Guangdong, China

The sites are constructed in conformance with the requirements of ANSI C63.7, ANSI C63.10 and CISPR Publication 22.

LABORATORY ACCREDITATIONS AND LISTINGS

Site Description

CNAS-Lab. : The Certificate Registration Number is L5516.

IC-Registration : The Certificate Registration Number is 9270A.
 CAB identifier:CN0074

FCC- Accredited : Test Firm Registration Number: 463705.
 Designation Number: CN1184

A2LA-Lab. : The Certificate Registration Number is 4298.01

Name of Firm : Shenzhen NTEK Testing Technology Co., Ltd.

Site Location : 1/F, Building E, Fenda Science Park Sanwei, Xixiang, Bao'an District
 Shenzhen, Guangdong, China

1.2 MEASUREMENT UNCERTAINTY

The reported uncertainty of measurement $y \pm U$, where expanded uncertainty U is based on a standard uncertainty multiplied by a coverage factor of $k=2$, providing a level of confidence of approximately 95 %.

No.	Item	Uncertainty
1	Conducted Emission Test	$\pm 2.80\text{dB}$
2	RF power, conducted	$\pm 0.16\text{dB}$
3	Spurious emissions, conducted	$\pm 0.21\text{dB}$
4	All emissions, radiated(30MHz~1GHz)	$\pm 2.64\text{dB}$
5	All emissions, radiated(1GHz~6GHz)	$\pm 2.40\text{dB}$
6	All emissions, radiated(> 6GHz)	$\pm 2.52\text{dB}$
7	Temperature	$\pm 0.5^\circ\text{C}$
8	Humidity	$\pm 2\%$

1. GENERAL INFORMATION
1.1 GENERAL DESCRIPTION OF EUT

Equipment	E-book reader																		
Trade Mark	MEEBOOK																		
Model Name	M6																		
Family Model	M6A, M6B, S6, S6H																		
Model Difference	All models are the same circuit and RF module, except the Model name and colour.																		
FCC ID	2A53E-M6																		
Product Description	<table border="1"> <tr> <td>Mode Supported</td> <td> <input checked="" type="checkbox"/>802.11a <input checked="" type="checkbox"/>802.11n(HT20) <input checked="" type="checkbox"/>802.11n(HT40) <input checked="" type="checkbox"/>802.11ac(HT20) <input checked="" type="checkbox"/>802.11ac(HT40) <input checked="" type="checkbox"/>802.11ac(HT80) </td> </tr> <tr> <td>Data Rate</td> <td> 802.11a: 6,9,12,18,24,36,48,54Mbps; 802.11n(HT20/HT40):MCS0-MCS15; 802.11ac(VHT20): NSS1, MCS0-MCS8 802.11ac(VHT40/VHT80):NSS1, MCS0-MCS9 </td> </tr> <tr> <td>Modulation</td> <td>OFDM with BPSK/QPSK/16QAM/64QAM</td> </tr> <tr> <td>Operating Frequency Range</td> <td> <input checked="" type="checkbox"/> U-NII-1: 5150 MHz ~5250MHz <input checked="" type="checkbox"/> U-NII-2A: 5250MHz~5350MHz <input checked="" type="checkbox"/> U-NII-2C: 5470MHz~5725MHz <input checked="" type="checkbox"/> U-NII-3: 5725 MHz ~5850 MHz </td> </tr> <tr> <td>Function:</td> <td> <input type="checkbox"/>Outdoor AP <input type="checkbox"/>Indoor AP <input type="checkbox"/>Fixed P2P <input checked="" type="checkbox"/>Client </td> </tr> <tr> <td>DFS type:</td> <td> <input type="checkbox"/>master devices <input type="checkbox"/>Slave devices with radar detection <input checked="" type="checkbox"/>Slave devices without radar detection </td> </tr> <tr> <td>Support TPC</td> <td> <input type="checkbox"/>YES <input checked="" type="checkbox"/>NO </td> </tr> <tr> <td>Antenna Type</td> <td>FPCB Antenna</td> </tr> <tr> <td>Antenna Gain</td> <td>-0.07 dBi</td> </tr> </table>	Mode Supported	<input checked="" type="checkbox"/> 802.11a <input checked="" type="checkbox"/> 802.11n(HT20) <input checked="" type="checkbox"/> 802.11n(HT40) <input checked="" type="checkbox"/> 802.11ac(HT20) <input checked="" type="checkbox"/> 802.11ac(HT40) <input checked="" type="checkbox"/> 802.11ac(HT80)	Data Rate	802.11a: 6,9,12,18,24,36,48,54Mbps; 802.11n(HT20/HT40):MCS0-MCS15; 802.11ac(VHT20): NSS1, MCS0-MCS8 802.11ac(VHT40/VHT80):NSS1, MCS0-MCS9	Modulation	OFDM with BPSK/QPSK/16QAM/64QAM	Operating Frequency Range	<input checked="" type="checkbox"/> U-NII-1: 5150 MHz ~5250MHz <input checked="" type="checkbox"/> U-NII-2A: 5250MHz~5350MHz <input checked="" type="checkbox"/> U-NII-2C: 5470MHz~5725MHz <input checked="" type="checkbox"/> U-NII-3: 5725 MHz ~5850 MHz	Function:	<input type="checkbox"/> Outdoor AP <input type="checkbox"/> Indoor AP <input type="checkbox"/> Fixed P2P <input checked="" type="checkbox"/> Client	DFS type:	<input type="checkbox"/> master devices <input type="checkbox"/> Slave devices with radar detection <input checked="" type="checkbox"/> Slave devices without radar detection	Support TPC	<input type="checkbox"/> YES <input checked="" type="checkbox"/> NO	Antenna Type	FPCB Antenna	Antenna Gain	-0.07 dBi
	Mode Supported	<input checked="" type="checkbox"/> 802.11a <input checked="" type="checkbox"/> 802.11n(HT20) <input checked="" type="checkbox"/> 802.11n(HT40) <input checked="" type="checkbox"/> 802.11ac(HT20) <input checked="" type="checkbox"/> 802.11ac(HT40) <input checked="" type="checkbox"/> 802.11ac(HT80)																	
	Data Rate	802.11a: 6,9,12,18,24,36,48,54Mbps; 802.11n(HT20/HT40):MCS0-MCS15; 802.11ac(VHT20): NSS1, MCS0-MCS8 802.11ac(VHT40/VHT80):NSS1, MCS0-MCS9																	
	Modulation	OFDM with BPSK/QPSK/16QAM/64QAM																	
	Operating Frequency Range	<input checked="" type="checkbox"/> U-NII-1: 5150 MHz ~5250MHz <input checked="" type="checkbox"/> U-NII-2A: 5250MHz~5350MHz <input checked="" type="checkbox"/> U-NII-2C: 5470MHz~5725MHz <input checked="" type="checkbox"/> U-NII-3: 5725 MHz ~5850 MHz																	
	Function:	<input type="checkbox"/> Outdoor AP <input type="checkbox"/> Indoor AP <input type="checkbox"/> Fixed P2P <input checked="" type="checkbox"/> Client																	
	DFS type:	<input type="checkbox"/> master devices <input type="checkbox"/> Slave devices with radar detection <input checked="" type="checkbox"/> Slave devices without radar detection																	
	Support TPC	<input type="checkbox"/> YES <input checked="" type="checkbox"/> NO																	
	Antenna Type	FPCB Antenna																	
	Antenna Gain	-0.07 dBi																	
Based on the application, features, or specification exhibited in User's Manual, More details of EUT technical specification, please refer to the User's Manual.																			
Adapter	N/A																		
Battery	DC 3.8V, 2000mAh																		
Power supply	DC 3.8V from battery or DC 5V from USB Port																		
Connecting I/O Port(s)	Please refer to the User's Manual																		
HW Version	K6 A1.1																		
SW Version	MEEBOOK-V1.4.0-2023030714																		

Note:

1. For a more detailed features description, please refer to the manufacturer's specifications or the User's Manual.
2. Frequency and Channel list:

Band	20MHz		40MHz		80MHz	
	Channel	Frequency	Channel	Frequency	Channel	Frequency
U-NII-1	36	5180 MHz	38	5190 MHz	42	5210 MHz
	40	5200 MHz	46	5230 MHz	-	-
	44	5220 MHz				
	48	5240 MHz				
U-NII-2A	52	5260 MHz	54	5270 MHz	58	5290 MHz
	56	5280 MHz	62	5310 MHz		
	60	5300 MHz				
	64	5320 MHz				
U-NII-2C	100	5500 MHz	102	5510 MHz	106	5530 MHz
	104	5520 MHz	110	5550 MHz	122	5610 MHz
	108	5540 MHz	118	5590 MHz		
	112	5560 MHz	126	5630 MHz		
	116	5580 MHz	134	5670 MHz		
	120	5600 MHz				
	124	5620 MHz				
	128	5640 MHz				
	132	5660 MHz				
	136	5680 MHz				
U-NII-3	149	5745 MHz	151	5755 MHz	155	5775 MHz
	153	5765 MHz	159	5795 MHz		
	157	5785 MHz				
	161	5805 MHz				
	165	5825 MHz				

1.2 DESCRIPTION OF TEST MODES

To investigate the maximum EMI emission characteristics generates from EUT, the test system was pre-scanning tested base on the consideration of following EUT operation mode or test configuration mode which possible have effect on EMI emission level. Each of these EUT operation mode(s) or test configuration mode(s) mentioned above was evaluated respectively.

For Radiated Emission	
Final Test Mode	Description
Mode 1	Normal Link Mode
Mode 2	802.11a / n/ ac 20 CH36/ CH40/ CH48/CH52/CH56/CH64/CH100/CH120/CH140/CH149/ CH157/CH165
Mode 3	802.11n40/ac40 CH38/CH46/CH54/CH62/CH102/CH118/CH134/CH151/ CH159
Mode 4	802.11ac80 CH42/CH58/CH106/CH122/CH155

For Conducted Emission	
Final Test Mode	Description
Mode 1	Normal Link Mode
Mode 2	802.11a / n/ ac 20 CH36/ CH40/ CH48/CH52/CH56/CH64/CH100/CH120/CH140/CH149/ CH157/CH165
Mode 3	802.11n40/ac40 CH38/CH46/CH54/CH62/CH102/CH118/CH134/CH151/ CH159
Mode 4	802.11ac80 CH42/CH58/CH106/CH122/CH155

Note:

- (1) The measurements are performed at the highest, middle, lowest available channels.
- (2) The measurements are performed at all Bit Rate of Transmitter, the worst data was reported

1.3 BLOCK DIGRAM SHOWING THE CONFIGURATION OF SYSTEM TESTED

For AC Conducted Emission Mode

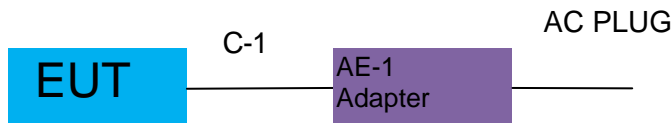

For Radiated Test Cases



For Conducted Test Cases

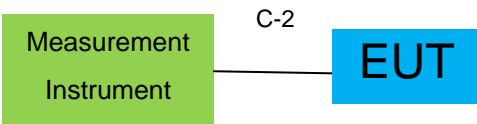

Note: 1. The temporary antenna connector is soldered on the PCB board in order to perform conducted tests and this temporary antenna connector is listed in the equipment list.

1.4 DESCRIPTION OF SUPPORT UNITS(CONDUCTED MODE)

The EUT has been tested as an independent unit together with other necessary accessories or support units. The following support units or accessories were used to form a representative test configuration during the tests.

Item	Equipment	Model/Type No.	Series No.	Note
AE-1	Adapter	N/A	N/A	Peripherals

Item	Cable Type	Shielded Type	Ferrite Core	Length	Note
C-1	USB Cable	NO	YES	1.0m	
C-2	RF Cable	YES	NO	0.1m	

Note:

- (1) The support equipment was authorized by Declaration of Confirmation.
- (2) For detachable type I/O cable should be specified the length in cm in 「Length」 column.
- (3) During the battery power test, the battery is fully charged.

1.5 EQUIPMENTS LIST FOR ALL TEST ITEMS

Radiation& Conducted Test equipment

Item	Kind of Equipment	Manufacturer	Type No.	Serial No.	Last calibration	Calibrated until	Calibration period
1	Spectrum Analyzer	Agilent	E4407B	MY45108040	2022.04.06	2023.04.05	1 year
2	Spectrum Analyzer	Agilent	N9020A	MY49100060	2022.04.06	2023.04.05	1 year
3	Spectrum Analyzer	R&S	FSV40	101417	2022.04.06	2023.04.05	1 year
4	Test Receiver	R&S	ESPI7	101318	2022.04.06	2023.04.05	1 year
5	Bilog Antenna	TESEQ	CBL6111D	31216	2022.03.30	2023.03.29	1 year
6	50Ω Coaxial Switch	Anritsu	MP59B	6200983705	2020.05.11	2023.05.10	3 year
7	Horn Antenna	EM	EM-AH-10180	2011071402	2022.03.31	2023.03.30	1 year
8	Amplifier	EMC	EMC051835SE	980246	2022.06.17	2023.06.16	1 year
9	Active Loop Antenna	SCHWARZBECK	FMZB 1519B	055	2022.06.17	2023.06.15	1 year
10	Power Meter	DARE	RPR3006W	15100041SN084	2022.11.08	2023.11.07	1 year
11	USB RF Power Sensor	DARE	RPR3006W	15100041SN084	2022.11.08	2023.11.07	1 year
12	Test Cable (9KHz-30MHz)	N/A	R-01	N/A	2022.06.17	2025.06.16	3 year
13	Test Cable (30MHz-1GHz)	N/A	R-02	N/A	2022.06.17	2025.06.16	3 year
14	High Test Cable(1G-40GHz)	N/A	R-03	N/A	2022.06.17	2025.06.16	3 year
15	High Test Cable(1G-40GHz)	N/A	R-04	N/A	2022.11.08	2023.11.07	1 year
16	Filter	TRILTHIC	2400MHz	29	2022.04.01	2023.03.31	1 year
17	temporary antenna connector (Note)	NTS	R001	N/A	N/A	N/A	N/A
18	Low Noise Amplifier	B&Z	BZ-P540-550850-452727	16476-11729	2022.04.01	2023.03.31	1 year
19	Broadband Horn Antenna	SCHWARZBECK	BBHA 9170	803	2022.04.01	2023.03.31	1 year
20	Thermal Chamber	Ten Billion	TTC-B3C	TBN-960502	2022.04.01	2023.03.31	1 year

Note:

We will use the temporary antenna connector (soldered on the PCB board) When conducted test
 And this temporary antenna connector is listed within the instrument list

AC Conduction Test equipment							
Item	Kind of Equipment	Manufacturer	Type No.	Serial No.	Last calibration	Calibrated until	Calibration period
1	Test Receiver	R&S	ESCI	101160	2022.04.06	2023.04.05	1 year
2	LISN	R&S	ENV216	101313	2022.06.17	2023.06.15	1 year
3	LISN	SCHWARZBECK	NNLK 8129	8129245	2022.04.06	2023.04.05	1 year
4	50Ω Coaxial Switch	ANRITSU CORP	MP59B	6200983704	2020.05.11	2023.05.10	3 year
5	Test Cable (9KHz-30MHz)	N/A	C01	N/A	2020.05.11	2023.05.10	3 year
6	Test Cable (9KHz-30MHz)	N/A	C02	N/A	2020.05.11	2023.05.10	3 year
7	Test Cable (9KHz-30MHz)	N/A	C03	N/A	2020.05.11	2023.05.10	3 year

Note: Each piece of equipment is scheduled for calibration once a year except the Test Cable& Aux Equipment which is scheduled for calibration every 3 years.

2. EMC EMISSION TEST

2.1 CONDUCTED EMISSION MEASUREMENT

2.1.1 APPLICABLE STANDARD

According to FCC Part 15.207(a)

2.1.2 CONFORMANCE LIMIT

Frequency(MHz)	Conducted Emission Limit	
	Quasi-peak	Average
0.15-0.5	66-56*	56-46*
0.5-5.0	56	46
5.0-30.0	60	50

Note: 1. *Decreases with the logarithm of the frequency
 2. The lower limit shall apply at the transition frequencies
 3. The limit decreases in line with the logarithm of the frequency in the range of 0.15 to 0.50MHz.

2.1.3 TEST CONFIGURATION

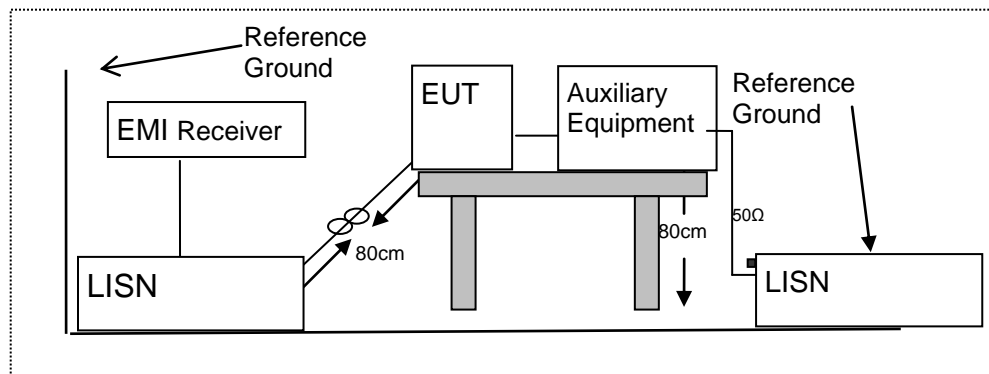

2.1.4 TEST PROCEDURE

According to the requirements in Section 13.1.4.1 of ANSI C63.10-2013 Conducted emissions the EUT measured in the frequency range between 0.15 MHz and 30 MHz using CISPR Quasi-Peak and average detector mode.

1. The EUT was placed 0.4 meter from the conducting wall of the shielding room.
2. The EUT was placed on a table which is 0.8m above ground plane.
3. Connect EUT to the power mains through a line impedance stabilization network (LISN). All other support equipments powered from additional LISN(s). The LISN provide 50 Ohm/ 50uH of coupling impedance for the measuring instrument.
4. Interconnecting cables that hang closer than 40 cm to the ground plane shall be folded back and forth in the center forming a bundle 30 to 40cm long.
5. I/O cables that are not connected to a peripheral shall be bundled in the center. The end of the cable may be terminated, if required, using the correct terminating impedance. The overall length shall not exceed 1 m.
6. LISN at least 80 cm from nearest part of EUT chassis.
7. The frequency range from 150KHz to 30MHz was searched.
8. Set the test-receiver system to Peak Detect Function and specified bandwidth(IF bandwidth=9KHz) with Maximum Hold Mode
9. For the actual test configuration, please refer to the related Item –EUT Test Photos.

EUT :	E-book reader	Model Name. :	M6
Temperature :	26 °C	Relative Humidity :	56%
Pressure :	1010hPa	Phase :	L
Test Voltage :	DC 5V from Adapter AC 120V/60Hz	Test Mode :	Mode 1(5.2G)

Frequency (MHz)	Reading Level (dBμV)	Correct Factor (dB)	Measure-ment (dBμV)	Limits (dBμV)	Margin (dB)	Remark
0.1500	40.79	9.60	50.39	65.99	-15.60	QP
0.1500	21.58	9.60	31.18	55.99	-24.81	AVG
0.2140	31.64	9.62	41.26	63.04	-21.78	QP
0.2140	9.73	9.62	19.35	53.04	-33.69	AVG
0.5540	21.28	9.67	30.95	56.00	-25.05	QP
0.5540	13.90	9.67	23.57	46.00	-22.43	AVG
0.7980	21.79	9.68	31.47	56.00	-24.53	QP
0.7980	18.75	9.68	28.43	46.00	-17.57	AVG
6.5500	21.14	9.83	30.97	60.00	-29.03	QP
6.5500	9.83	9.83	19.66	50.00	-30.34	AVG
11.3620	19.65	9.97	29.62	60.00	-30.38	QP
11.3620	10.01	9.97	19.98	50.00	-30.02	AVG

Remark:

1. All readings are Quasi-Peak and Average values.
2. Factor = Insertion Loss + Cable Loss.

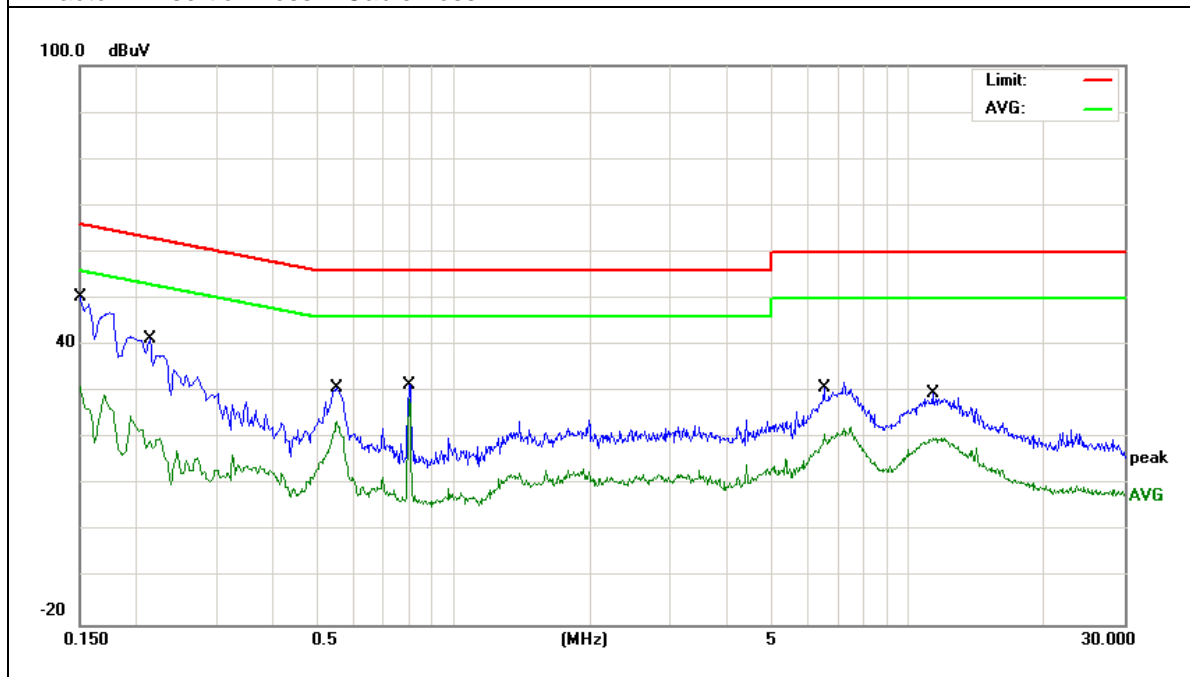

EUT :	E-book reader	Model Name. :	M6
Temperature :	26 °C	Relative Humidity :	56%
Pressure :	1010hPa	Phase :	N
Test Voltage :	DC 5V from Adapter AC 120V/60Hz	Test Mode :	Mode 1(5.2G)

Frequency (MHz)	Reading Level (dBμV)	Correct Factor (dB)	Measure-ment (dBμV)	Limits (dBμV)	Margin (dB)	Remark
0.1500	41.12	9.65	50.77	65.99	-15.22	QP
0.1500	24.75	9.65	34.40	55.99	-21.59	AVG
0.5540	20.21	9.67	29.88	56.00	-26.12	QP
0.5540	11.07	9.67	20.74	46.00	-25.26	AVG
0.7980	22.41	9.68	32.09	56.00	-23.91	QP
0.7980	19.20	9.68	28.88	46.00	-17.12	AVG
1.3460	14.45	9.67	24.12	56.00	-31.88	QP
1.3460	5.52	9.67	15.19	46.00	-30.81	AVG
6.8300	17.77	9.81	27.58	60.00	-32.42	QP
6.8300	6.77	9.81	16.58	50.00	-33.42	AVG
11.5060	18.60	9.94	28.54	60.00	-31.46	QP
11.5060	9.66	9.94	19.60	50.00	-30.40	AVG

Remark:

1. All readings are Quasi-Peak and Average values.
2. Factor = Insertion Loss + Cable Loss.

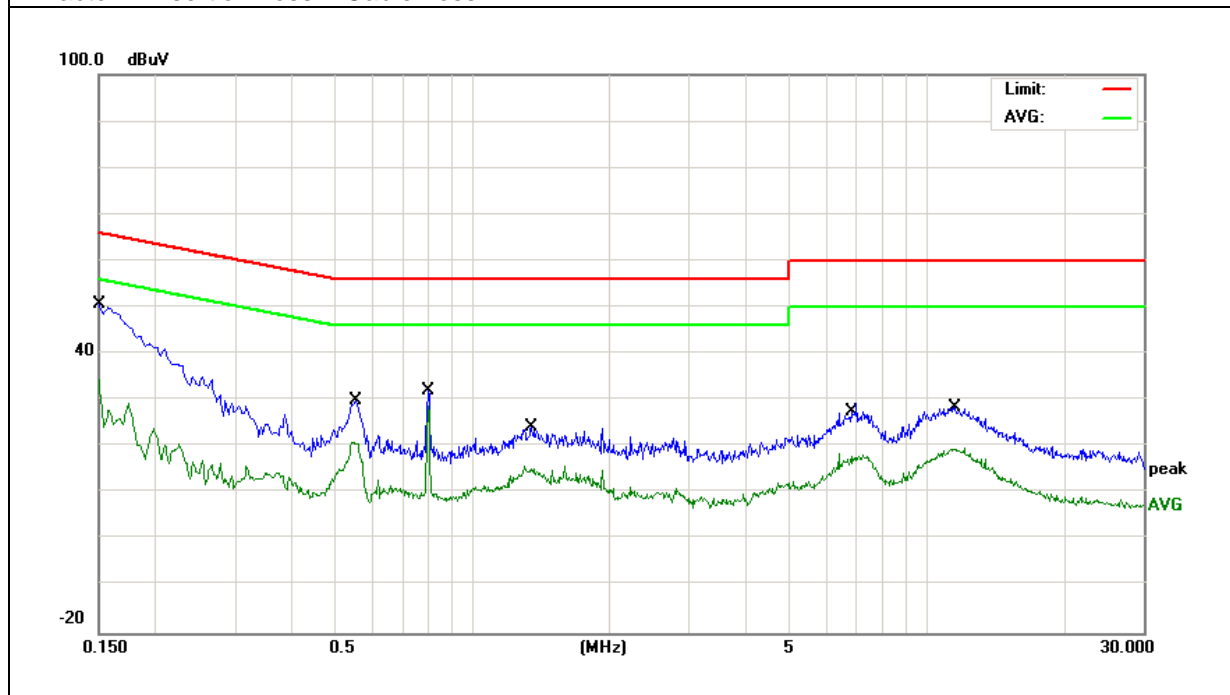

EUT :	E-book reader	Model Name. :	M6
Temperature :	26 °C	Relative Humidity :	56%
Pressure :	1010hPa	Phase :	L
Test Voltage :	DC 5V from Adapter AC 120V/60Hz	Test Mode :	Mode 1(5.3G)

Frequency (MHz)	Reading Level (dBμV)	Correct Factor (dB)	Measurement (dBμV)	Limits (dBμV)	Margin (dB)	Remark
0.1940	42.61	9.61	52.22	63.86	-11.64	QP
0.1940	12.51	9.61	22.12	53.86	-31.74	AVG
0.2340	40.29	9.63	49.92	62.30	-12.38	QP
0.2340	8.54	9.63	18.17	52.30	-34.13	AVG
0.5100	33.37	9.66	43.03	56.00	-12.97	QP
0.5100	21.34	9.66	31.00	46.00	-15.00	AVG
0.8900	30.24	9.68	39.92	56.00	-16.08	QP
0.8900	10.36	9.68	20.04	46.00	-25.96	AVG
2.2340	25.47	9.69	35.16	56.00	-20.84	QP
2.2340	10.70	9.69	20.39	46.00	-25.61	AVG
11.4900	23.48	9.97	33.45	60.00	-26.55	QP
11.4900	9.67	9.97	19.64	50.00	-30.36	AVG

Remark:

1. All readings are Quasi-Peak and Average values.
2. Factor = Insertion Loss + Cable Loss.

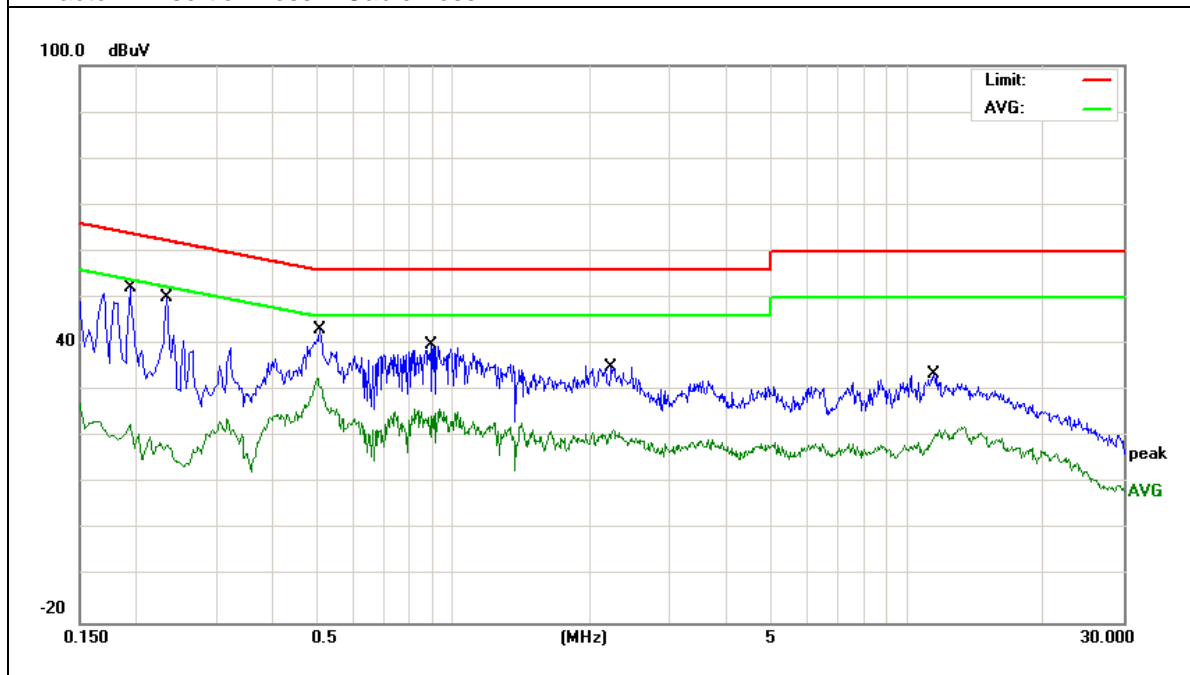

EUT :	E-book reader	Model Name. :	M6
Temperature :	26 °C	Relative Humidity :	56%
Pressure :	1010hPa	Phase :	N
Test Voltage :	DC 5V from Adapter AC 120V/60Hz	Test Mode :	Mode 1(5.3G)

Frequency (MHz)	Reading Level (dBμV)	Correct Factor (dB)	Measure-ment (dBμV)	Limits (dBμV)	Margin (dB)	Remark
0.1580	43.60	9.65	53.25	65.56	-12.31	QP
0.1580	11.61	9.65	21.26	55.56	-34.30	AVG
0.2140	40.54	9.63	50.17	63.04	-12.87	QP
0.2140	6.53	9.63	16.16	53.04	-36.88	AVG
0.5140	33.94	9.66	43.60	56.00	-12.40	QP
0.5140	10.93	9.66	20.59	46.00	-25.41	AVG
0.8340	32.97	9.68	42.65	56.00	-13.35	QP
0.8340	13.84	9.68	23.52	46.00	-22.48	AVG
1.9500	28.30	9.67	37.97	56.00	-18.03	QP
1.9500	7.56	9.67	17.23	46.00	-28.77	AVG
3.5500	26.00	9.71	35.71	56.00	-20.29	QP
3.5500	5.44	9.71	15.15	46.00	-30.85	AVG

Remark:

1. All readings are Quasi-Peak and Average values.
2. Factor = Insertion Loss + Cable Loss.

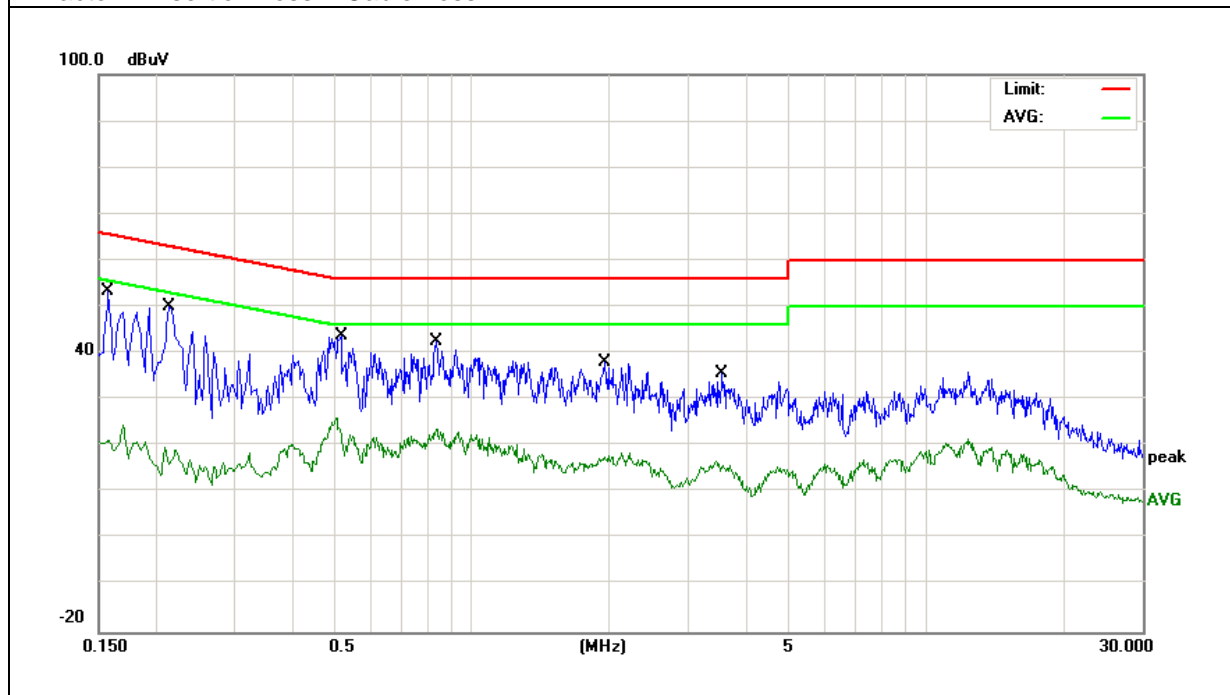

EUT :	E-book reader	Model Name. :	M6
Temperature :	26 °C	Relative Humidity :	56%
Pressure :	1010hPa	Phase :	L
Test Voltage :	DC 5V from Adapter AC 120V/60Hz	Test Mode :	Mode 1(5.6G)

Frequency (MHz)	Reading Level (dBμV)	Correct Factor (dB)	Measurement (dBμV)	Limits (dBμV)	Margin (dB)	Remark
0.1580	45.61	9.60	55.21	65.56	-10.35	QP
0.1580	14.89	9.60	24.49	55.56	-31.07	AVG
0.1780	43.45	9.61	53.06	64.57	-11.51	QP
0.1780	9.26	9.61	18.87	54.57	-35.70	AVG
0.5020	31.85	9.66	41.51	56.00	-14.49	QP
0.5020	20.22	9.66	29.88	46.00	-16.12	AVG
0.9260	28.95	9.68	38.63	56.00	-17.37	QP
0.9260	15.56	9.68	25.24	46.00	-20.76	AVG
3.2940	21.29	9.74	31.03	56.00	-24.97	QP
3.2940	8.82	9.74	18.56	46.00	-27.44	AVG
11.1260	22.27	9.96	32.23	60.00	-27.77	QP
11.1260	9.31	9.96	19.27	50.00	-30.73	AVG

Remark:

1. All readings are Quasi-Peak and Average values.
2. Factor = Insertion Loss + Cable Loss.

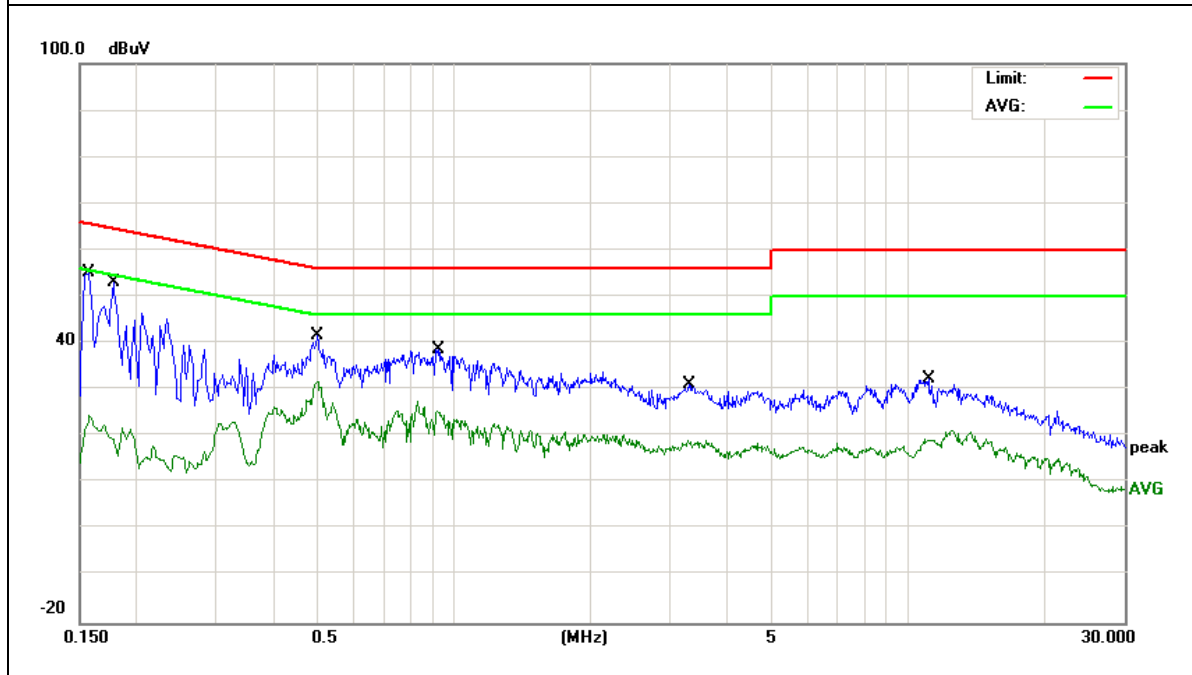

EUT :	E-book reader	Model Name. :	M6
Temperature :	26 °C	Relative Humidity :	56%
Pressure :	1010hPa	Phase :	N
Test Voltage :	DC 5V from Adapter AC 120V/60Hz	Test Mode :	Mode 1(5.6G)

Frequency (MHz)	Reading Level (dBμV)	Correct Factor (dB)	Measure-ment (dBμV)	Limits (dBμV)	Margin (dB)	Remark
0.1580	46.96	9.65	56.61	65.56	-8.95	QP
0.1580	17.19	9.65	26.84	55.56	-28.72	AVG
0.4980	36.18	9.66	45.84	56.03	-10.19	QP
0.4980	15.32	9.66	24.98	46.03	-21.05	AVG
0.8500	31.54	9.68	41.22	56.00	-14.78	QP
0.8500	12.02	9.68	21.70	46.00	-24.30	AVG
3.2180	25.01	9.70	34.71	56.00	-21.29	QP
3.2180	5.43	9.70	15.13	46.00	-30.87	AVG
5.8340	21.66	9.78	31.44	60.00	-28.56	QP
5.8340	5.26	9.78	15.04	50.00	-34.96	AVG
11.8740	25.09	9.96	35.05	60.00	-24.95	QP
11.8740	10.44	9.96	20.40	50.00	-29.60	AVG

Remark:

1. All readings are Quasi-Peak and Average values.
2. Factor = Insertion Loss + Cable Loss.

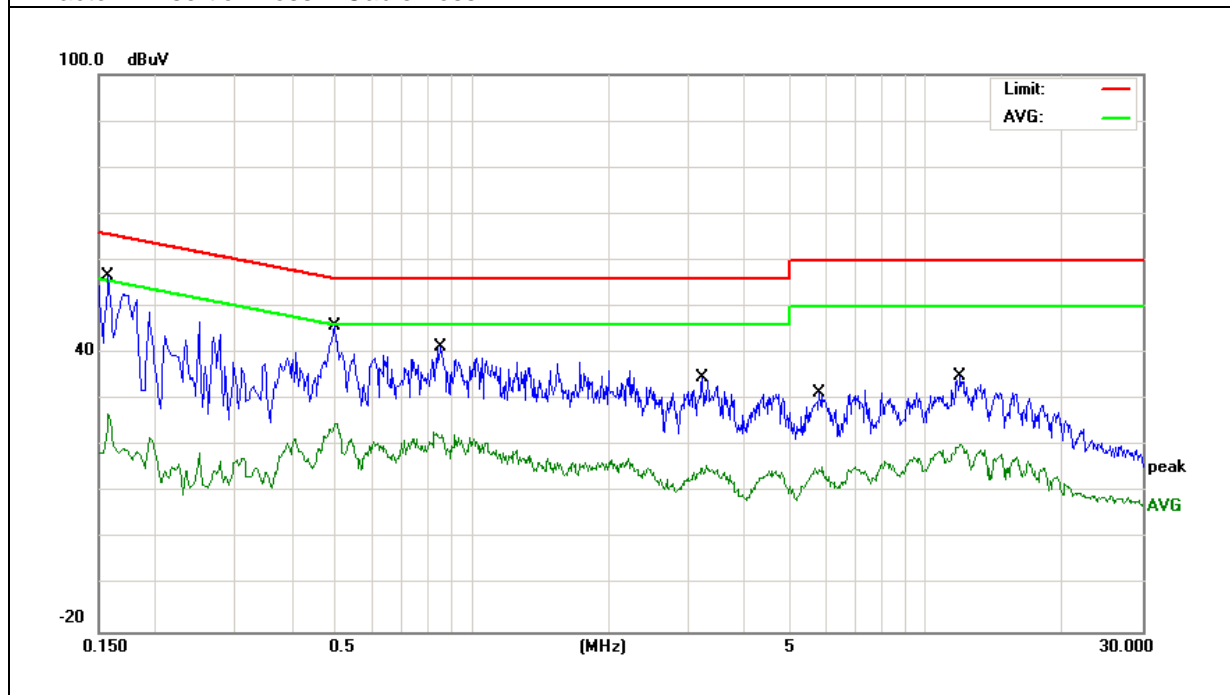

EUT :	E-book reader	Model Name. :	M6
Temperature :	26 °C	Relative Humidity :	56%
Pressure :	1010hPa	Phase :	L
Test Voltage :	DC 5V from Adapter AC 120V/60Hz	Test Mode :	Mode 1(5.8G)

Frequency (MHz)	Reading Level (dBμV)	Correct Factor (dB)	Measure-ment (dBμV)	Limits (dBμV)	Margin (dB)	Remark
0.1580	29.66	9.60	39.26	65.56	-26.30	QP
0.1580	19.51	9.60	29.11	55.56	-26.45	AVG
0.5340	27.61	9.66	37.27	56.00	-18.73	QP
0.5340	16.59	9.66	26.25	46.00	-19.75	AVG
0.8020	28.13	9.68	37.81	56.00	-18.19	QP
0.8020	15.57	9.68	25.25	46.00	-20.75	AVG
2.2299	25.28	9.69	34.97	56.00	-21.03	QP
2.2299	14.67	9.69	24.36	46.00	-21.64	AVG
8.6178	24.18	9.89	34.07	60.00	-25.93	QP
8.6178	14.26	9.89	24.15	50.00	-25.85	AVG
18.4539	20.29	10.15	30.44	60.00	-29.56	QP
18.4539	9.87	10.15	20.02	50.00	-29.98	AVG

Remark:

1. All readings are Quasi-Peak and Average values.
2. Factor = Insertion Loss + Cable Loss.

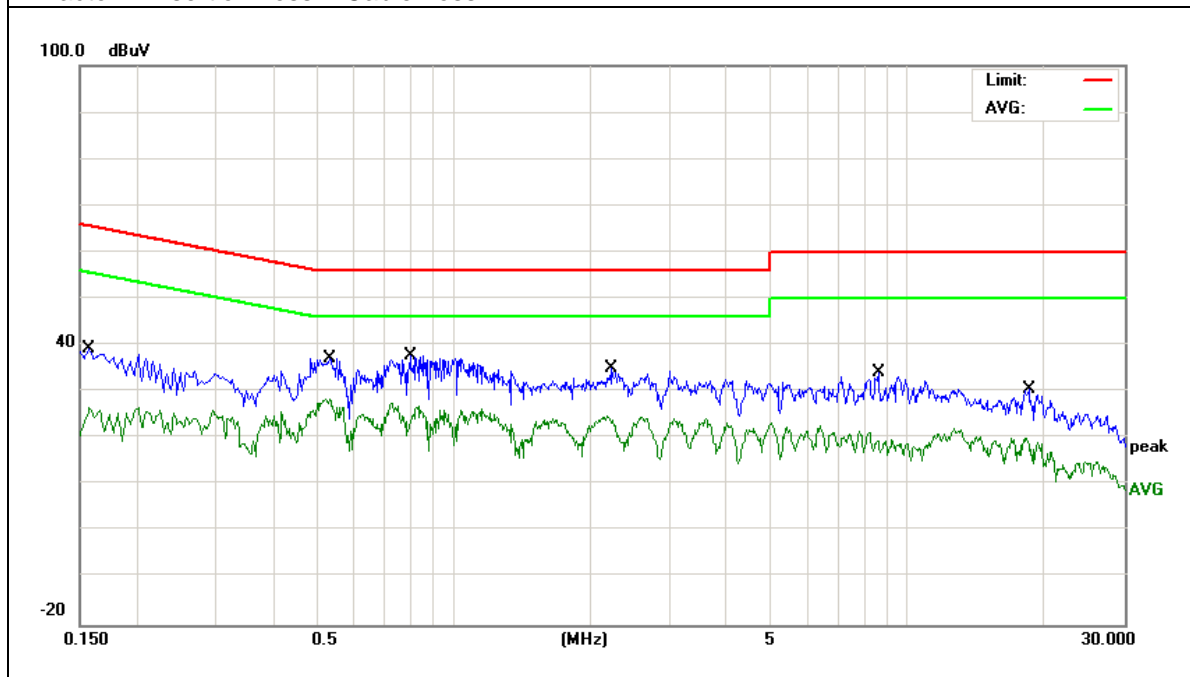

EUT :	E-book reader	Model Name. :	M6
Temperature :	26 °C	Relative Humidity :	56%
Pressure :	1010hPa	Phase :	N
Test Voltage :	DC 5V from Adapter AC 120V/60Hz	Test Mode :	Mode 1(5.8G)

Frequency (MHz)	Reading Level (dBμV)	Correct Factor (dB)	Measure-ment (dBμV)	Limits (dBμV)	Margin (dB)	Remark
0.1700	27.70	9.65	37.35	64.96	-27.61	QP
0.1700	17.37	9.65	27.02	54.96	-27.94	AVG
0.5020	31.65	9.66	41.31	56.00	-14.69	QP
0.5020	21.44	9.66	31.10	46.00	-14.90	AVG
0.8419	29.93	9.68	39.61	56.00	-16.39	QP
0.8419	18.52	9.68	28.20	46.00	-17.80	AVG
1.0620	29.35	9.68	39.03	56.00	-16.97	QP
1.0620	19.62	9.68	29.30	46.00	-16.70	AVG
2.1739	25.72	9.67	35.39	56.00	-20.61	QP
2.1739	15.48	9.67	25.15	46.00	-20.85	AVG
10.7459	22.42	9.92	32.34	60.00	-27.66	QP
10.7459	12.62	9.92	22.54	50.00	-27.46	AVG

Remark:

1. All readings are Quasi-Peak and Average values.
2. Factor = Insertion Loss + Cable Loss.

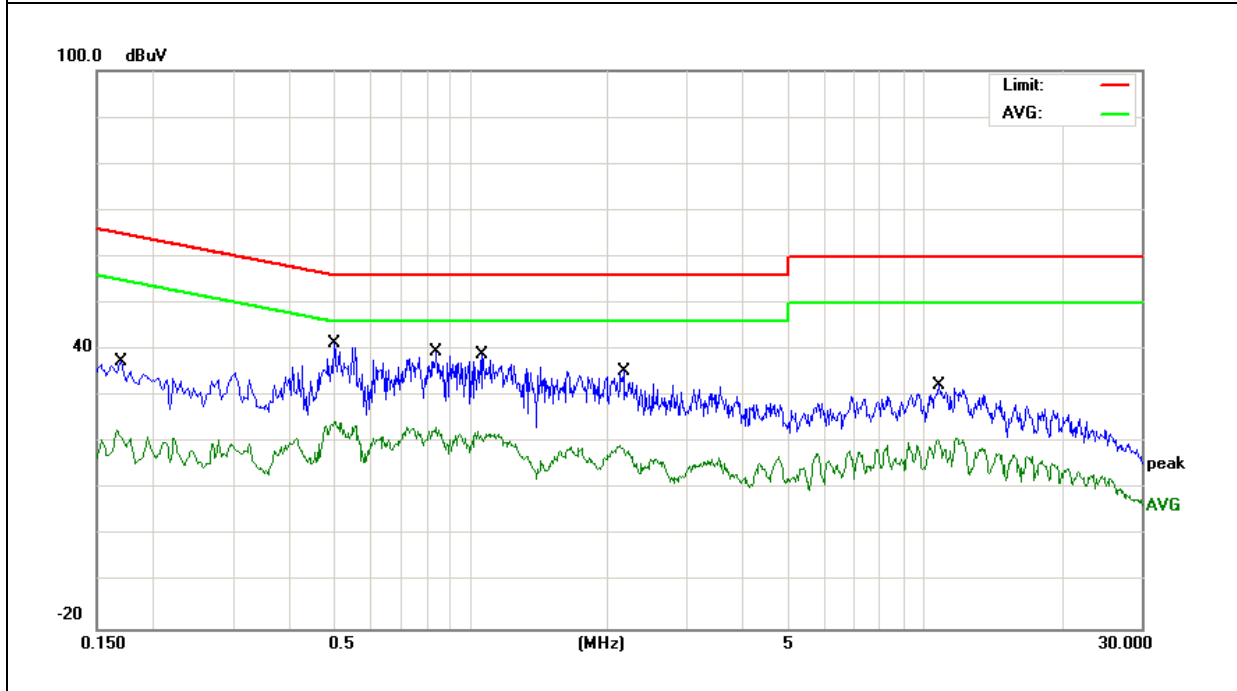

2.2 RADIATED EMISSION MEASUREMENT

2.2.1 APPLICABLE STANDARD

According to FCC Part 15.407(d) and 15.209

2.2.2 CONFORMANCE LIMIT

According to FCC Part 15.407(b)(7): radiated emissions which fall in the restricted bands, as defined in §15.205(a), must also comply with the radiated emission limits specified in §15.209(a) (see §15.205(c)).
According to FCC Part 15.205, Restricted bands

MHz	MHz	MHz	GHz
0.090-0.110	16.42-16.423	399.9-410	4.5-5.15
0.495-0.505	16.69475-16.69525	608-614	5.35-5.46
2.1735-2.1905	16.80425-16.80475	960-1240	7.25-7.75
4.125-4.128	25.5-25.67	1300-1427	8.025-8.5
4.17725-4.17775	37.5-38.25	1435-1626.5	9.0-9.2
4.20725-4.20775	73-74.6	1645.5-1646.5	9.3-9.5
6.215-6.218	74.8-75.2	1660-1710	10.6-12.7
6.26775-6.26825	123-138	2200-2300	14.47-14.5
8.291-8.294	149.9-150.05	2310-2390	15.35-16.2
8.362-8.366	156.52475-156.52525	2483.5-2500	17.7-21.4
8.37625-8.38675	156.7-156.9	2690-2900	22.01-23.12
8.41425-8.41475	162.0125-167.17	3260-3267	23.6-24.0
12.29-12.293	167.72-173.2	3332-3339	31.2-31.8
12.51975-12.52025	240-285	3345.8-3358	36.43-36.5
12.57675-12.57725	322-335.4	3600-4400	(2)
13.36-13.41			

20dBc in any 100 kHz bandwidth outside the operating frequency band. In case the emission fall within the restricted band specified on 15.205(a), then the 15.209(a) limit in the table below has to be followed.

Restricted Frequency(MHz)	Field Strength (µV/m)	Field Strength (dBµV/m)	Measurement Distance
0.009-0.490	2400/F(KHz)	20 log (uV/m)	300
0.490-1.705	24000/F(KHz)	20 log (uV/m)	30
1.705-30.0	30	29.5	30
30-88	100	40	3
88-216	150	43.5	3
216-960	200	46	3
Above 960	500	54	3

Limits of Radiated Emission Measurement(Above 1000MHz)

Frequency(MHz)	Class B (dBuV/m) (at 3M)	
	PEAK	AVERAGE
Above 1000	74	54

Remark :1. Emission level in dBuV/m=20 log (uV/m)
 2. Measurement was performed at an antenna to the closed point of EUT distance of meters.
 3. For Frequency 9kHz~30MHz:
 Distance extrapolation factor =40log(Specific distance/ test distance)(dB);
 Limit line=Specific limits(dBuV) + distance extrapolation factor.
 For Frequency above 30MHz:
 Distance extrapolation factor =20log(Specific distance/ test distance)(dB);
 Limit line=Specific limits(dBuV) + distance extrapolation factor.

2.2.3 MEASURING INSTRUMENTS

The Measuring equipment is listed in the section 6.3 of this test report.

2.2.4 TEST CONFIGURATION

(a) For radiated emissions below 30MHz

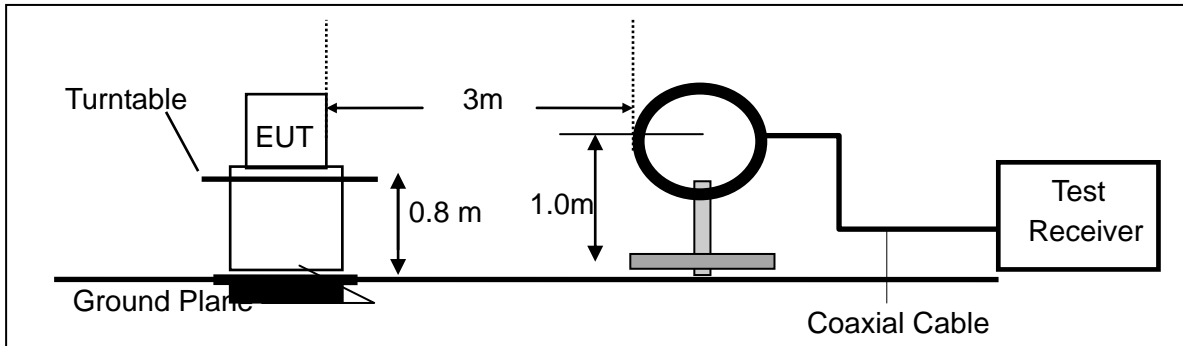

(b) For radiated emissions from 30MHz to 1000MHz

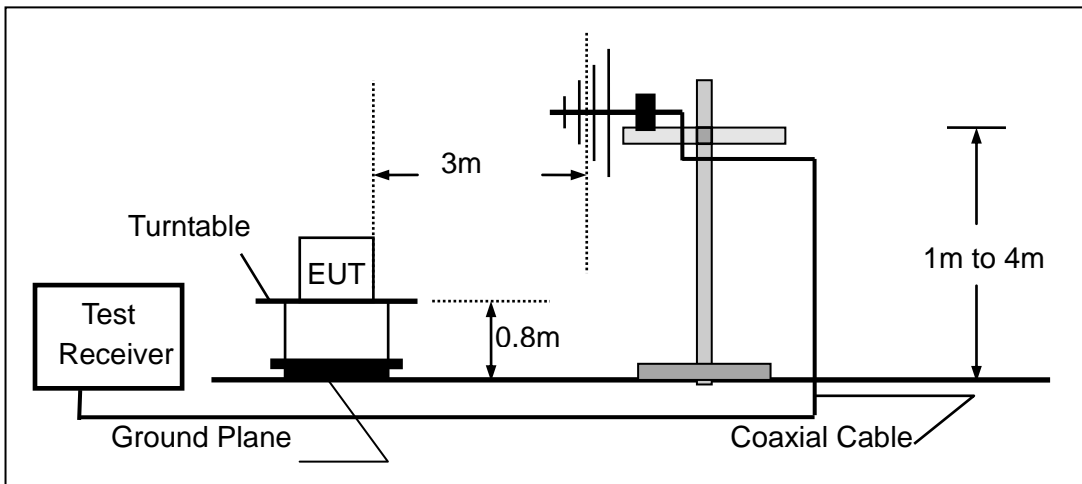

(c) For radiated emissions above 1000MHz

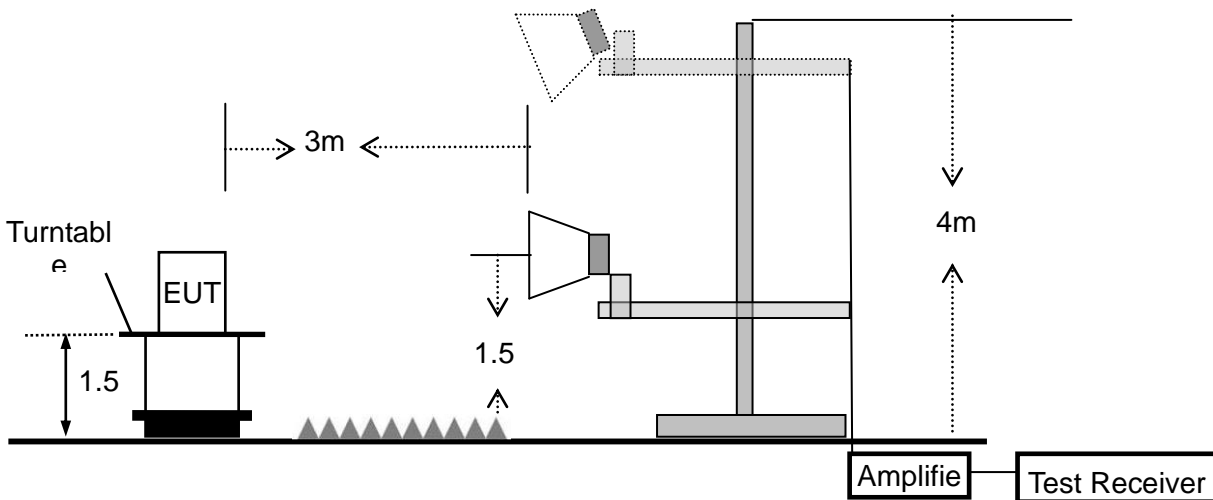

2.2.5 TEST PROCEDURE

The test site semi-anechoic chamber has met the requirement of NSA tolerance 4 dB according to the standards: ANSI C63.10-2013. The test distance is 3m. The setup is according to the requirements in Section 13.1.4.1 of ANSI C63.10-2013 and CAN/CSA-CEI/IEC CISPR 22.

This test is required for any spurious emission that falls in a Restricted Band, as defined in Section 15.205. It must be performed with the highest gain of each type of antenna proposed for use with the EUT.

Use the following spectrum analyzer settings:

Spectrum Parameter	Setting
Attenuation	Auto
Start Frequency	1000 MHz
Stop Frequency	10th carrier harmonic
RB / VB (emission in restricted band)	1 MHz / 1 MHz for Peak, 1 MHz / 10Hz for Average

Receiver Parameter	Setting
Attenuation	Auto
Start ~ Stop Frequency	9kHz~150kHz / RB 200Hz for QP
Start ~ Stop Frequency	150kHz~30MHz / RB 9kHz for QP
Start ~ Stop Frequency	30MHz~1000MHz / RB 120kHz for QP

- The measuring distance of at 3 m shall be used for measurements at frequency up to 1GHz. For frequencies above 1GHz, any suitable measuring distance may be used.
- The EUT was placed on the top of a rotating table 0.8 m for below 1GHz and 1.5m for above 1GHz the ground at a 3 meter. The table was rotated 360 degrees to determine the position of the highest radiation.
- The height of the equipment or of the substitution antenna shall be 0.8 m for below 1GHz and 1.5m for above 1GHz; the height of the test antenna shall vary between 1 m to 4 m. Both horizontal and vertical polarizations of the antenna are set to make the measurement.
- The initial step in collecting conducted emission data is a spectrum analyzer peak detector mode pre-scanning the measurement frequency range. Significant peaks are then marked and then Quasi Peak detector mode re-measured.
- If the Peak Mode measured value compliance with and lower than Quasi Peak Mode Limit, the EUT shall be deemed to meet QP Limits and then no additional QP Mode measurement performed.
- For the actual test configuration, please refer to the related Item –EUT Test Photos.

Note:

Both horizontal and vertical antenna polarities were tested and performed pretest to three orthogonal axis. The worst case emissions were reported

During the radiated emission test, the Spectrum Analyzer was set with the following configurations:

Frequency Band (MHz)	Function	Resolution bandwidth	Video Bandwidth
30 to 1000	QP	120 kHz	300 kHz
Above 1000	Peak	1 MHz	1 MHz
	Average	1 MHz	10 Hz

Note: for the frequency ranges below 30 MHz, a narrower RBW is used for these ranges but the measured value should add a RBW correction factor (RBWCF) where $RBWCF [dB] = 10 \cdot \lg(100 [kHz] / \text{narrower RBW [kHz]})$. , the narrower RBW is 1 kHz and RBWCF is 20 dB for the frequency 9 kHz to 150 kHz, and the narrower RBW is 10 kHz and RBWCF is 10 dB for the frequency 150 kHz to 30 MHz.

2.2.6 TEST RESULTS (9KHZ – 30 MHZ)

EUT :	E-book reader	Model Name :	M6
Temperature :	26 °C	Relative Humidity :	54%
Pressure:	1010 hPa	Test Voltage :	DC 3.8V
Test Mode :	TX	Polarization :	--

Freq.	Reading	Limit	Margin	State
(MHz)	(dBuV/m)	(dBuV/m)	(dB)	P/F
--	--	--	--	N/A
--	--	--	--	N/A

NOTE:

The amplitude of spurious emissions which are attenuated by more than 20dB below the permissible value has no need to be reported.

2.2.7 TEST RESULTS (30MHZ – 1GHZ)

EUT :	E-book reader	Model Name :	M6
Temperature :	26 °C	Relative Humidity :	54%
Pressure :	1010 hPa	Test Voltage :	DC 3.8V
Test Mode :	TX(5.2G)- 802.11ac40 (Low CH)		

Polar (H/V)	Frequency	Meter Reading	Factor	Emission Level	Limits	Margin	Remark
	(MHz)	(dBuV)	(dB)	(dBuV/m)	(dBuV/m)	(dB)	
V	45.5348	12.89	17.54	30.43	40.00	-9.57	QP
V	119.8556	12.89	18.83	31.72	43.50	-11.78	QP
V	169.5990	16.63	17.53	34.16	43.50	-9.34	QP
V	199.9856	17.08	16.60	33.68	43.50	-9.82	QP
V	360.4476	11.66	22.15	33.81	46.00	-12.19	QP
V	440.1963	11.48	23.98	35.46	46.00	-10.54	QP

Remark:

Absolute Level= ReadingLevel+ Factor, Margin= Absolute Level - Limit

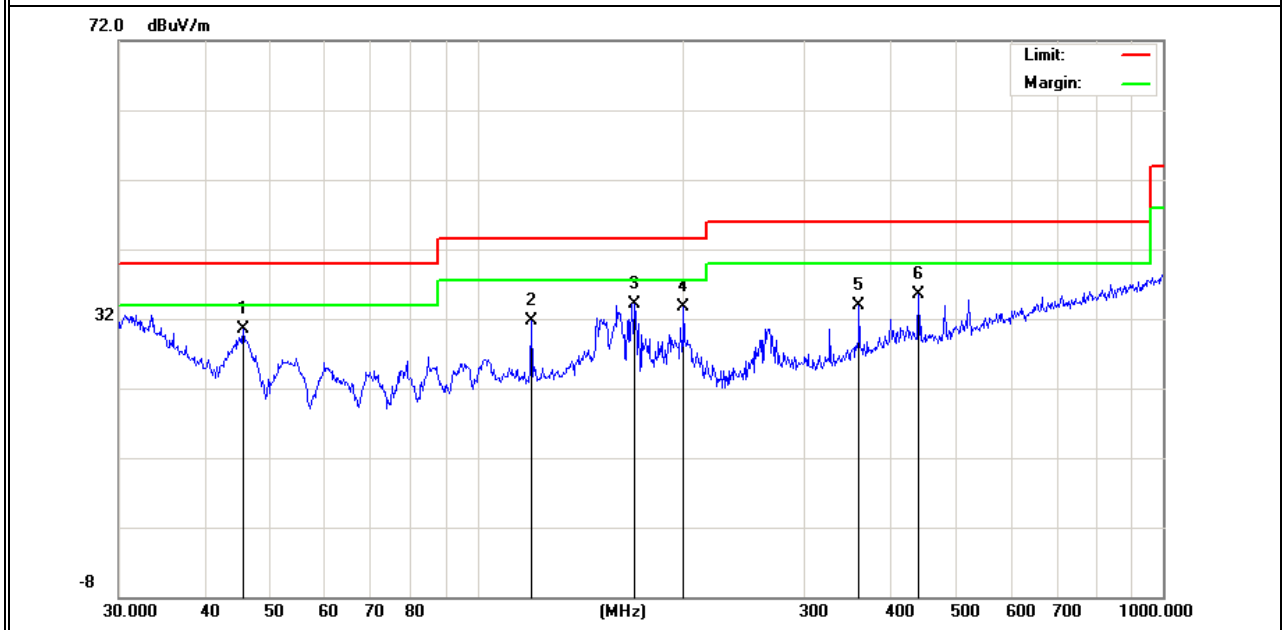

Polar (H/V)	Frequency	Meter Reading	Factor	Emission Level	Limits	Margin	Remark
	(MHz)	(dBuV)	(dB)	(dBuV/m)	(dBuV/m)	(dB)	
H	161.4742	9.69	17.98	27.67	43.50	-15.83	QP
H	167.8243	11.13	17.36	28.49	43.50	-15.01	QP
H	265.6757	12.30	19.63	31.93	46.00	-14.07	QP
H	360.4476	19.51	22.15	41.66	46.00	-4.34	QP
H	440.1963	18.29	23.98	42.27	46.00	-3.73	QP
H	520.8882	11.96	25.23	37.19	46.00	-8.81	QP

Remark:

Absolute Level= ReadingLevel+ Factor, Margin= Absolute Level - Limit

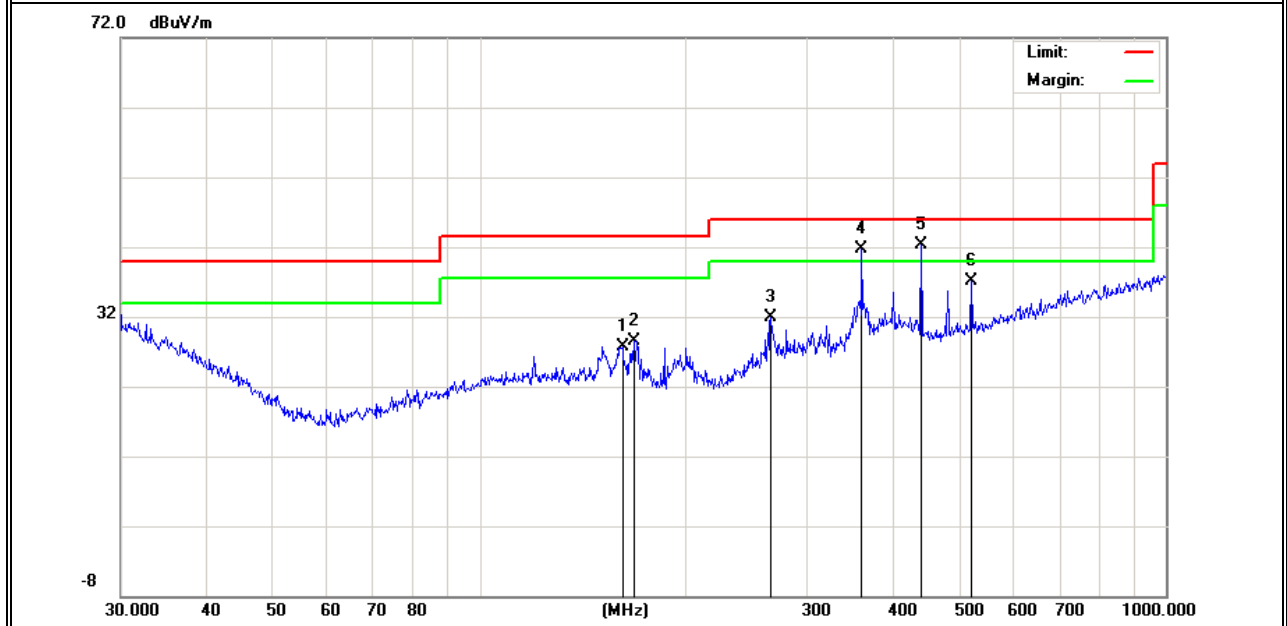

EUT :	E-book reader	Model Name :	M6
Temperature :	26 °C	Relative Humidity :	54%
Pressure :	1010 hPa	Test Voltage :	DC 3.8V
Test Mode :	TX(5.3G)- 802.11n40 (Middle CH)		

Polar (H/V)	Frequency	Meter Reading	Factor	Emission Level	Limits	Margin	Remark
	(MHz)	(dBuV)	(dB)	(dBuV/m)	(dBuV/m)	(dB)	
V	119.8556	14.54	18.83	33.37	43.50	-10.13	QP
V	169.0054	17.60	17.29	34.89	43.50	-8.61	QP
V	199.9856	18.22	16.60	34.82	43.50	-8.68	QP
V	280.0237	10.63	20.08	30.71	46.00	-15.29	QP
V	360.4476	12.08	22.15	34.23	46.00	-11.77	QP
V	440.1963	12.59	23.98	36.57	46.00	-9.43	QP

Remark:

Absolute Level= ReadingLevel+ Factor, Margin= Absolute Level - Limit

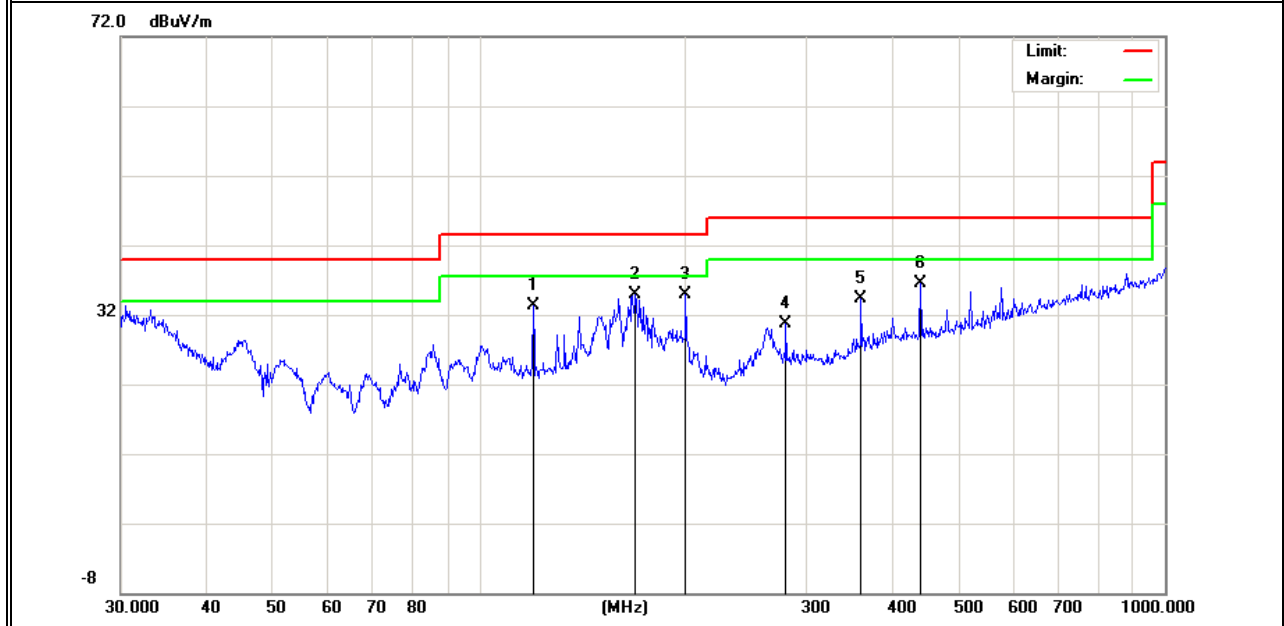

Polar (H/V)	Frequency	Meter Reading	Factor	Emission Level	Limits	Margin	Remark
	(MHz)	(dBuV)	(dB)	(dBuV/m)	(dBuV/m)	(dB)	
H	50.7637	11.98	14.81	26.79	40.00	-13.21	QP
H	159.7844	12.26	18.23	30.49	43.50	-13.01	QP
H	275.1570	18.95	19.50	38.45	46.00	-7.55	QP
H	360.4476	19.65	22.15	41.80	46.00	-4.20	QP
H	439.9963	18.74	23.97	42.71	46.00	-3.29	QP
H	520.8882	13.10	25.23	38.33	46.00	-7.67	QP

Remark:

Absolute Level= ReadingLevel+ Factor, Margin= Absolute Level - Limit

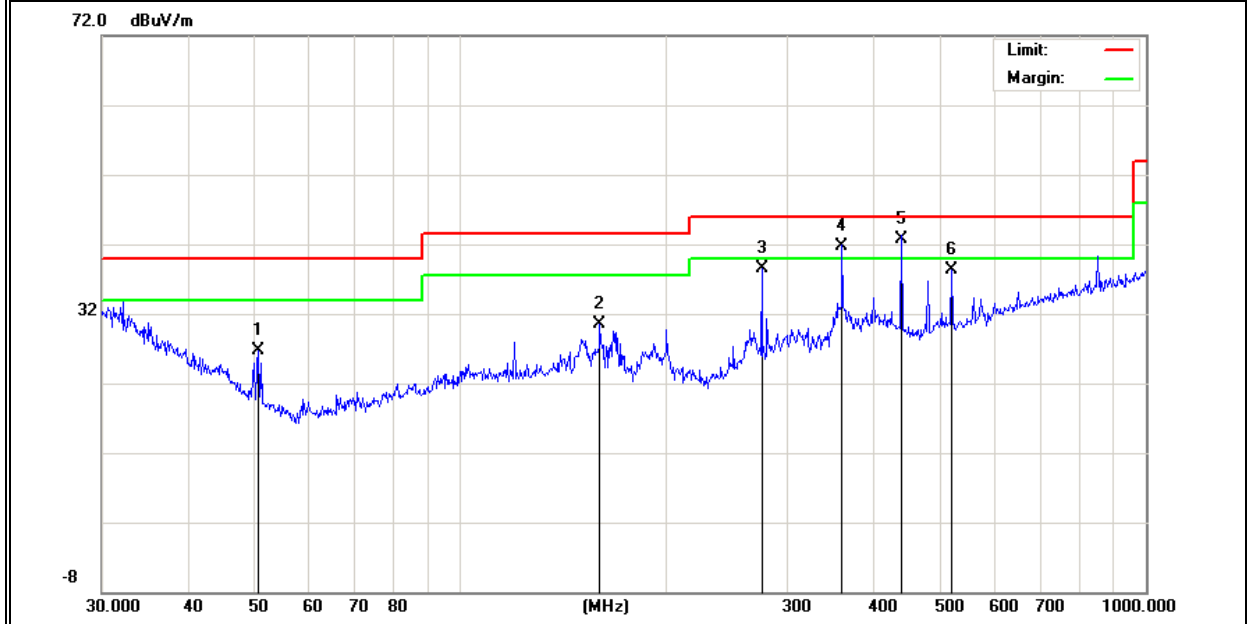

EUT :	E-book reader	Model Name :	M6
Temperature :	26 °C	Relative Humidity :	54%
Pressure :	1010 hPa	Test Voltage :	DC 3.8V
Test Mode :	TX(5.6G)- 802.11n20 (Low CH)		

Polar (H/V)	Frequency	Meter Reading	Factor	Emission Level	Limits	Margin	Remark
	(MHz)	(dBuV)	(dB)	(dBuV/m)	(dBuV/m)	(dB)	
V	32.7486	7.54	24.53	32.07	40.00	-7.93	QP
V	39.2991	11.16	21.05	32.21	40.00	-7.79	QP
V	148.4410	16.24	18.51	34.75	43.50	-8.75	QP
V	167.8240	18.45	17.36	35.81	43.50	-7.69	QP
V	265.6757	12.02	19.63	31.65	46.00	-14.35	QP
V	440.1963	10.84	23.98	34.82	46.00	-11.18	QP

Remark:

Absolute Level= ReadingLevel+ Factor, Margin= Absolute Level - Limit

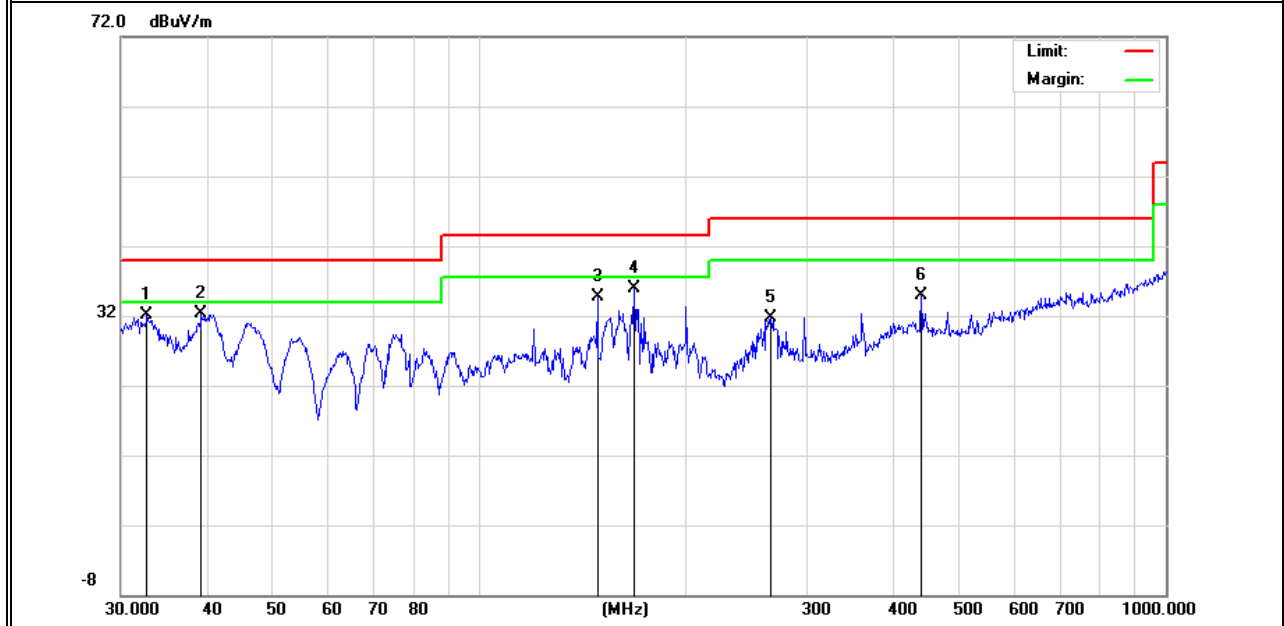

Polar (H/V)	Frequency	Meter Reading	Factor	Emission Level	Limits	Margin	Remark
	(MHz)	(dBuV)	(dB)	(dBuV/m)	(dBuV/m)	(dB)	
H	33.2111	6.80	24.28	31.08	40.00	-8.92	QP
H	148.4410	10.73	18.51	29.24	43.50	-14.26	QP
H	265.6757	12.16	19.63	31.79	46.00	-14.21	QP
H	297.2241	14.53	20.03	34.56	46.00	-11.44	QP
H	440.1963	16.02	23.98	40.00	46.00	-6.00	QP
H	520.8881	11.61	25.23	36.84	46.00	-9.16	QP

Remark:

Absolute Level= ReadingLevel+ Factor, Margin= Absolute Level - Limit

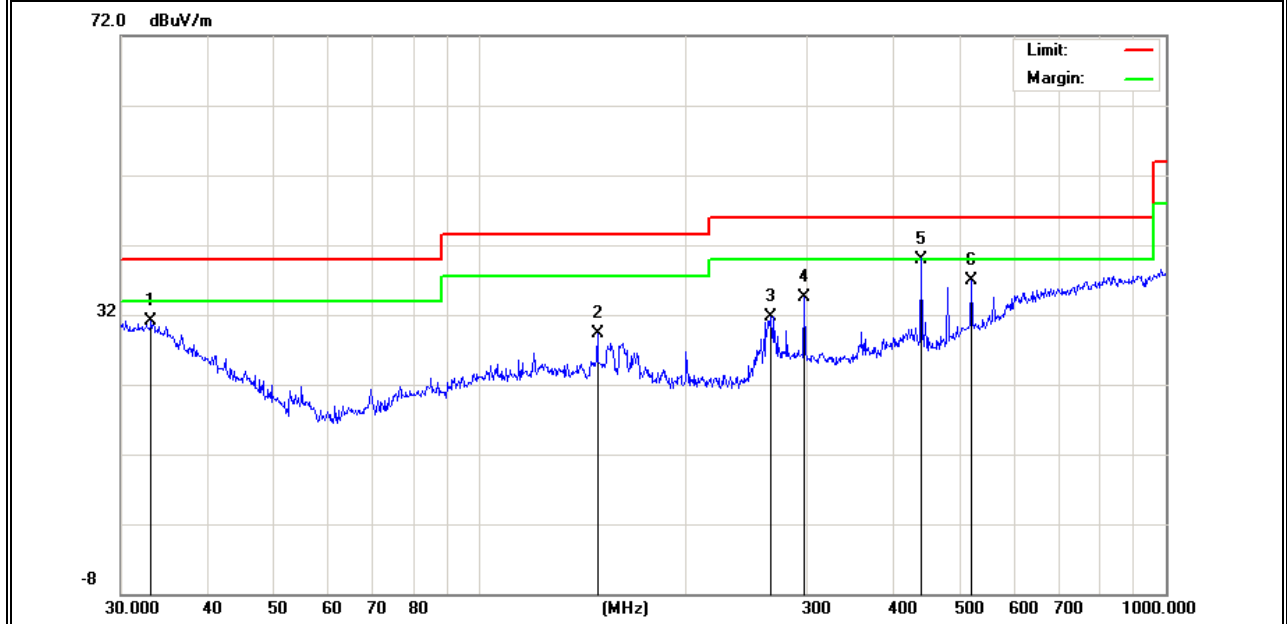

EUT :	E-book reader	Model Name :	M6
Temperature :	26 °C	Relative Humidity :	54%
Pressure :	1010 hPa	Test Voltage :	DC 3.8V
Test Mode :	TX(5.8G) - 802.11ac40 (Low CH)		

Polar (H/V)	Frequency	Meter Reading	Factor	Emission Level	Limits	Margin	Remark
	(MHz)	(dBuV)	(dB)	(dBuV/m)	(dBuV/m)	(dB)	
V	32.7486	9.04	24.53	33.57	40.00	-6.43	QP
V	40.4172	12.84	20.25	33.09	40.00	-6.91	QP
V	148.4410	16.74	18.51	35.25	43.50	-8.25	QP
V	199.9856	17.76	16.60	34.36	43.50	-9.14	QP
V	265.6757	13.52	19.63	33.15	46.00	-12.85	QP
V	440.1963	13.34	23.98	37.32	46.00	-8.68	QP

Remark:

Absolute Level= ReadingLevel+ Factor, Margin= Absolute Level - Limit

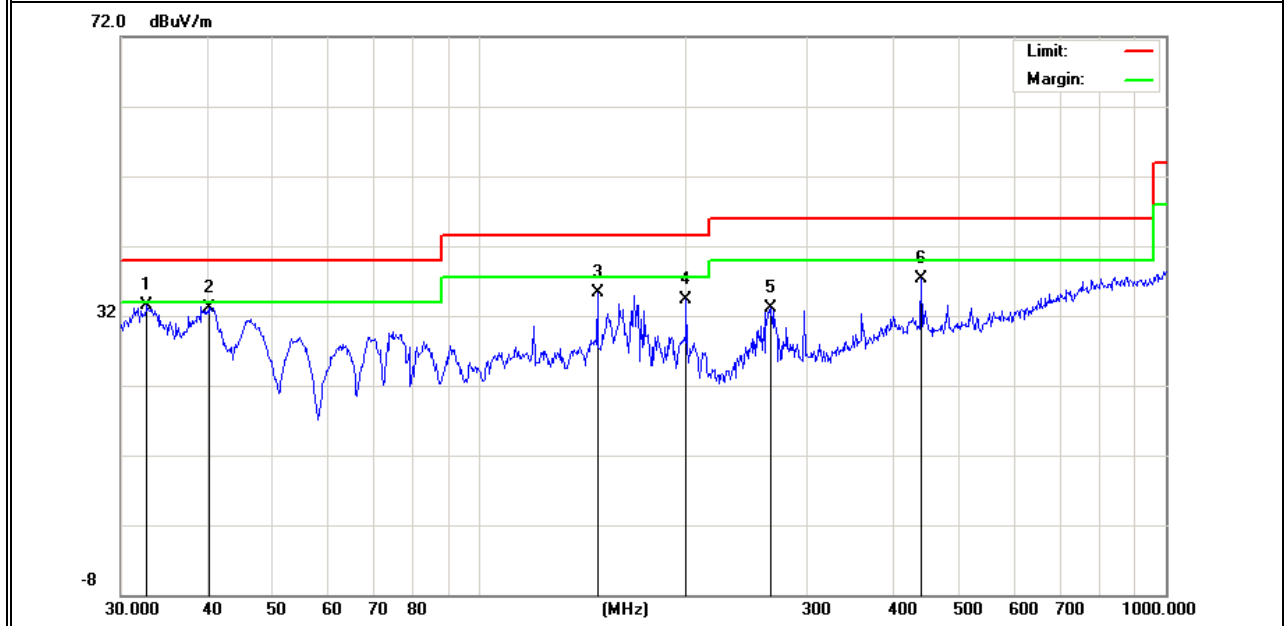

Polar (H/V)	Frequency	Meter Reading	Factor	Emission Level	Limits	Margin	Remark
	(MHz)	(dBuV)	(dB)	(dBuV/m)	(dBuV/m)	(dB)	
H	30.6374	6.41	25.87	32.28	40.00	-7.72	QP
H	148.4410	11.23	18.51	29.74	43.50	-13.76	QP
H	267.5455	12.13	19.52	31.65	46.00	-14.35	QP
H	297.2241	14.03	20.03	34.06	46.00	-11.94	QP
H	440.1963	16.02	23.98	40.00	46.00	-6.00	QP
H	520.8881	11.61	25.23	36.84	46.00	-9.16	QP

Remark:

Absolute Level= ReadingLevel+ Factor, Margin= Absolute Level - Limit

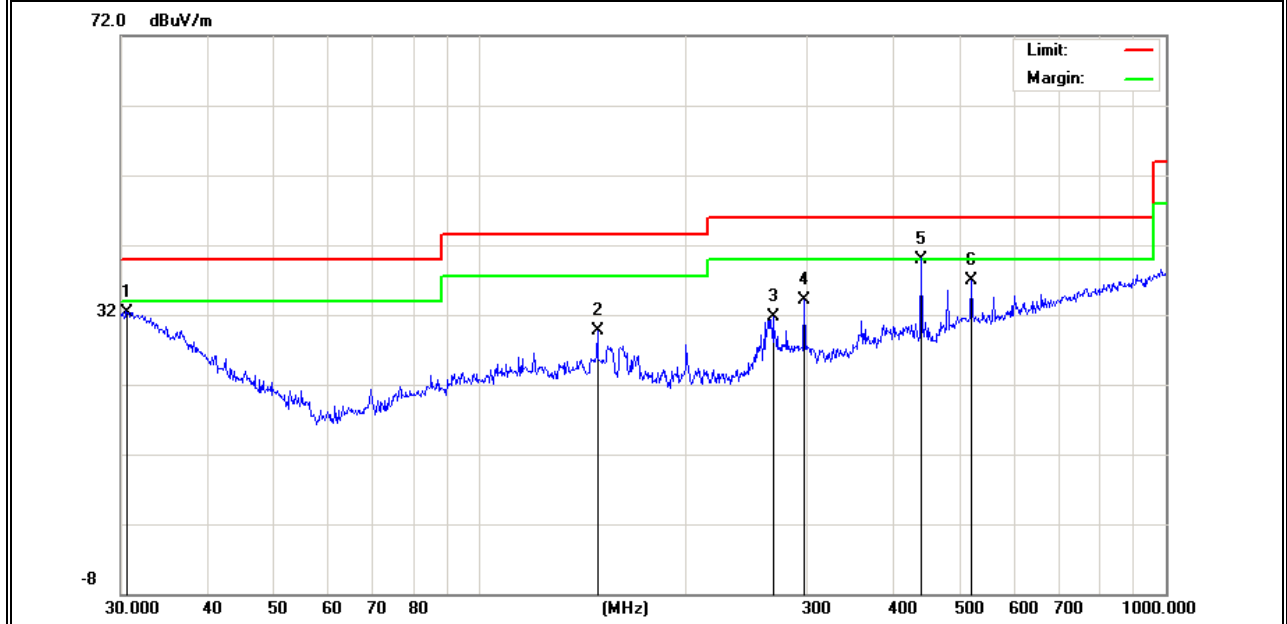

Note: All modes have been tested, just the the worst mode has been recorded in the report.

2.2.8 TEST RESULTS (1GHz-18GHz)

EUT :	E-book reader	Model Name. :	M6
Temperature :	20 °C	Relative Humidity :	48%
Pressure :	1010 hPa	Test Voltage :	DC 3.8V
Test Mode :	TX(5.2G) - 802.11ac20 _5190~5230MHz		

Polar	Frequency	Meter Reading	Cable loss	Antenna Factor	Preamp Factor	Emission Level	Limits	Margin	Detector Type
(H/V)	(MHz)	(dBuV)	(dB)	dB/m	(dB)	(dBuV/m)	(dBuV/m)	(dB)	
Low Channel (5180 MHz)-Above 1G									
Vertical	3694.10	60.44	5.94	35.40	44.00	57.78	74.00	-16.22	Pk
Vertical	3694.10	40.50	5.94	35.40	44.00	37.84	54.00	-16.16	AV
Vertical	10360.15	59.89	8.46	39.75	44.50	63.60	68.20	-4.60	Pk
Vertical	15540.22	60.32	10.12	38.80	44.10	65.14	74.00	-8.86	Pk
Vertical	15540.22	40.25	10.12	38.80	42.70	46.47	54.00	-7.53	AV
Horizontal	3713.00	60.10	5.94	35.18	44.00	57.22	74.00	-16.78	Pk
Horizontal	3713.00	39.78	5.94	35.18	44.00	36.90	54.00	-17.10	AV
Horizontal	10360.47	59.19	8.46	38.71	44.50	61.86	68.20	-6.34	Pk
Horizontal	15540.38	60.66	10.12	38.38	44.10	65.06	74.00	-8.94	Pk
Horizontal	15540.38	40.73	10.12	38.38	44.10	45.13	54.00	-8.87	AV
middle Channel (5200 MHz)-Above 1G									
Vertical	3624.13	59.14	6.48	36.35	44.05	57.92	74.00	-16.08	Pk
Vertical	3624.13	39.96	6.48	36.35	44.05	38.74	54.00	-15.26	AV
Vertical	10400.09	59.44	8.47	37.88	44.51	61.28	68.20	-6.92	Pk
Vertical	15600.15	59.04	10.12	38.80	44.10	63.86	74.00	-10.14	Pk
Vertical	15600.15	39.93	10.12	38.80	42.70	46.15	54.00	-7.85	AV
Horizontal	4202.14	60.90	6.48	36.37	44.05	59.70	74.00	-14.30	Pk
Horizontal	4202.14	40.67	6.48	36.37	44.05	39.47	54.00	-14.53	AV
Horizontal	10400.14	59.83	8.47	38.64	44.50	62.44	68.20	-5.76	Pk
Horizontal	15600.51	60.93	10.12	38.38	44.10	65.33	74.00	-8.67	Pk
Horizontal	15600.51	39.89	10.12	38.38	44.10	44.29	54.00	-9.71	AV

High Channel (5240 MHz)-Above 1G									
Vertical	4597.70	59.72	7.10	37.24	43.50	60.56	74.00	-13.44	Pk
Vertical	4597.70	40.06	7.10	37.24	43.50	40.90	54.00	-13.10	AV
Vertical	10480.23	60.02	8.46	37.68	44.50	61.66	68.20	-6.54	Pk
Vertical	15720.15	60.38	10.12	38.80	44.10	65.20	74.00	-8.80	Pk
Vertical	15720.15	40.64	10.12	38.80	42.70	46.86	54.00	-7.14	AV
Horizontal	4589.26	59.57	7.10	37.24	43.50	60.41	74.00	-13.59	Pk
Horizontal	4589.26	39.79	7.10	37.24	43.50	40.63	54.00	-13.37	AV
Horizontal	10480.59	60.82	8.46	38.57	44.50	63.35	68.20	-4.85	Pk
Horizontal	15720.18	59.13	10.12	38.38	44.10	63.53	74.00	-10.47	Pk
Horizontal	15720.18	40.05	10.12	38.38	44.10	44.45	54.00	-9.55	AV

Note: "802.11ac20(5G)" mode is the worst mode. PK value is lower than the Average value limit, So average didn't record.

The amplitude of spurious emissions that are attenuated by more than 20dB below the permissible value has no need to be reported.

Emission level (dBuV/m) = 20 log Emission level (uV/m).

Corrected Reading: Antenna Factor + Cable Loss + Read Level - Preamp Factor = Level.

EUT :	E-book reader	Model Name. :	M6
Temperature :	20 °C	Relative Humidity :	48%
Pressure :	1010 hPa	Test Voltage :	DC 3.8V
Test Mode :	TX(5.3G) - 802.11ac20_5260~5320MHz		

Polar	Frequency	Meter Reading	Cable loss	Antenna Factor	Preamp Factor	Emission Level	Limits	Margin	Detector Type
(H/V)	(MHz)	(dBuV)	(dB)	dB/m	(dB)	(dBuV/m)	(dBuV/m)	(dB)	
Low Channel (5260 MHz)-Above 1G									
Vertical	4633.25	59.24	5.44	35.40	44.00	56.08	74.00	-17.92	Pk
Vertical	4633.25	39.08	5.74	35.40	44.00	36.22	54.00	-17.78	AV
Vertical	10520.12	59.84	8.26	39.75	44.50	63.35	68.20	-4.85	Pk
Vertical	15780.34	60.42	10.12	38.80	44.10	65.23	74.00	-8.77	Pk
Vertical	15780.34	40.22	9.62	38.80	42.70	45.94	54.00	-8.06	AV
Horizontal	4366.15	59.64	5.57	35.18	44.00	56.38	74.00	-17.62	Pk
Horizontal	4366.15	40.91	5.74	35.18	44.00	37.83	54.00	-16.17	AV
Horizontal	10520.26	59.44	8.38	38.71	44.50	62.03	68.20	-6.17	Pk
Horizontal	15780.34	59.58	9.88	38.38	44.10	63.74	74.00	-10.26	Pk
Horizontal	15780.34	40.32	9.94	38.38	44.10	44.54	54.00	-9.46	AV
middle Channel (5280 MHz)-Above 1G									
Vertical	4122.34	59.41	6.08	36.35	44.05	57.78	74.00	-16.22	Pk
Vertical	4122.34	39.74	6.39	36.35	44.05	38.43	54.00	-15.57	AV
Vertical	10560.19	60.00	8.28	37.88	44.51	61.66	68.20	-6.54	Pk
Vertical	15840.36	60.72	9.79	38.8	44.10	65.21	74.00	-8.79	Pk
Vertical	15840.36	39.16	9.70	38.8	42.70	44.95	54.00	-9.05	AV
Horizontal	3869.48	60.31	6.11	36.37	44.05	58.74	74.00	-15.26	Pk
Horizontal	3869.48	39.23	6.27	36.37	44.05	37.82	54.00	-16.18	AV
Horizontal	10560.74	60.38	8.33	38.64	44.50	62.85	68.20	-5.35	Pk
Horizontal	15840.37	60.25	9.99	38.38	44.10	64.52	74.00	-9.48	Pk
Horizontal	15840.37	40.02	9.81	38.38	44.10	44.11	54.00	-9.89	AV

High Channel (5320 MHz)-Above 1G									
Vertical	5366.52	59.13	6.96	37.24	43.50	59.83	74.00	-14.17	Pk
Vertical	5366.52	40.22	7.07	37.24	43.50	41.03	54.00	-12.97	AV
Vertical	10640.58	60.60	8.14	37.68	44.50	61.92	74.00	-12.08	Pk
Vertical	10640.58	39.15	8.35	37.68	44.50	40.68	54.00	-13.32	AV
Vertical	15960.41	40.31	10.11	38.8	44.10	45.12	74.00	-28.88	Pk
Vertical	15960.41	40.03	9.64	38.8	42.70	45.77	54.00	-8.23	AV
Horizontal	5436.59	59.11	7.05	37.24	43.50	59.90	74.00	-14.10	Pk
Horizontal	5436.59	40.48	7.05	37.24	43.50	41.27	54.00	-12.73	AV
Horizontal	10640.24	59.14	8.20	38.57	44.50	61.41	74.00	-12.59	Pk
Horizontal	10640.24	40.57	8.03	38.57	44.50	42.68	54.00	-11.32	AV
Horizontal	15960.88	50.95	9.81	38.38	44.10	55.04	74.00	-18.96	Pk
Horizontal	15960.88	39.64	9.96	38.38	44.10	43.88	54.00	-10.12	AV

Note: ANT 1 802.11ac20(5G) mode is the worst mode. PK value is lower than the Average value limit, So average didn't record.

The amplitude of spurious emissions that are attenuated by more than 20dB below the permissible value has no need to be reported.

Emission level (dBuV/m) = 20 log Emission level (uV/m).

Corrected Reading: Antenna Factor + Cable Loss + Read Level - Preamp Factor = Level.

EUT :	E-book reader	Model Name. :	M6
Temperature :	20 °C	Relative Humidity :	48%
Pressure :	1010 hPa	Test Voltage :	DC 3.8V
Test Mode :	TX(5.6G) - 802.11ac20 _5500~5700MHz		

Polar	Frequency	Meter Reading	Cable loss	Antenna Factor	Preamp Factor	Emission Level	Limits	Margin	Detector Type
(H/V)	(MHz)	(dBuV)	(dB)	dB/m	(dB)	(dBuV/m)	(dBuV/m)	(dB)	
Low Channel (5500 MHz)-Above 1G									
Vertical	5433.02	60.37	5.61	35.40	44.00	57.38	74.00	-16.62	Pk
Vertical	5433.02	49.57	5.76	35.40	44.00	46.74	54.00	-7.26	AV
Vertical	11000.25	59.40	8.24	39.75	44.50	62.89	74.00	-11.11	Pk
Vertical	11000.25	39.26	8.35	39.75	44.50	42.86	54.00	-11.14	AV
Vertical	16500.41	60.25	10.05	38.80	44.10	65.00	68.20	-3.20	Pk
Horizontal	5126.47	60.20	5.78	35.18	44.00	57.16	74.00	-16.84	Pk
Horizontal	5126.47	50.71	5.66	35.18	44.00	47.55	54.00	-6.45	AV
Horizontal	11000.32	59.40	8.22	38.71	44.50	61.84	74.00	-12.16	Pk
Horizontal	11000.32	39.10	8.14	38.71	44.50	41.45	54.00	-12.55	AV
Horizontal	16500.47	56.57	10.04	38.38	44.10	60.89	68.20	-7.31	Pk
Middle Channel (5600 MHz)-Above 1G									
Vertical	4933.25	59.80	6.29	36.35	44.05	58.38	74.00	-15.62	Pk
Vertical	4933.25	50.82	6.24	36.35	44.05	49.36	54.00	-4.64	AV
Vertical	11200.58	60.25	8.24	37.88	44.51	61.87	74.00	-12.13	Pk
Vertical	11200.58	40.90	8.13	37.88	44.51	42.40	54.00	-11.60	AV
Vertical	16800.45	60.75	9.71	38.80	44.10	65.16	68.20	-3.04	Pk
Horizontal	4766.32	59.17	6.44	36.37	44.05	57.93	74.00	-16.07	Pk
Horizontal	4766.32	49.84	6.13	36.37	44.05	48.29	54.00	-5.71	AV
Horizontal	11200.45	60.01	8.31	38.64	44.50	62.46	74.00	-11.54	Pk
Horizontal	11200.45	39.96	8.04	38.64	44.50	42.14	54.00	-11.86	AV
Horizontal	16800.33	56.30	10.09	38.38	44.10	60.66	68.20	-7.54	Pk

High Channel (5700 MHz)-Above 1G									
Vertical	5647.33	59.93	6.79	37.24	43.50	60.46	68.20	-7.74	Pk
Vertical	11400.29	59.21	8.10	37.68	44.50	60.49	74.00	-13.51	Pk
Vertical	11400.29	40.00	8.23	37.68	44.50	41.41	54.00	-12.59	AV
Vertical	17100.54	49.28	9.70	38.80	44.10	53.68	68.20	-14.52	Pk
Horizontal	5433.26	60.40	6.74	37.24	43.50	60.89	74.00	-13.11	Pk
Horizontal	5433.26	39.67	6.74	37.24	43.50	40.15	54.00	-13.85	AV
Horizontal	11400.43	50.05	8.25	38.57	44.50	52.38	74.00	-21.62	Pk
Horizontal	11400.43	39.46	8.35	38.57	44.50	41.88	54.00	-12.12	AV
Horizontal	17100.58	39.78	9.70	38.38	44.10	43.76	68.20	-24.44	Pk

Note: "802.11ac20(5G)" mode is the worst mode. PK value is lower than the Average value limit, So average didn't record.

The amplitude of spurious emissions that are attenuated by more than 20dB below the permissible value has no need to be reported.

Emission level (dBuV/m) = 20 log Emission level (uV/m).

Corrected Reading: Antenna Factor + Cable Loss + Read Level - Preamp Factor = Level.

EUT :	E-book reader	Model Name. :	M6
Temperature :	20 °C	Relative Humidity :	48%
Pressure :	1010 hPa	Test Voltage :	DC 3.8V
Test Mode :	TX (5.8G) -- 802.11a_5745~5825MHz		

Polar	Frequency	Meter Reading	Cable loss	Antenna Factor	Preamp Factor	Emission Level	Limits	Margin	Detector Type
(H/V)	(MHz)	(dBuV)	(dB)	dB/m	(dB)	(dBuV/m)	(dBuV/m)	(dB)	
Low Channel (5745 MHz)-Above 1G									
Vertical	5122.51	59.11	5.94	35.40	44.00	56.45	74.00	-17.55	Pk
Vertical	5122.51	40.74	5.94	35.40	44.00	38.08	54.00	-15.92	AV
Vertical	11490.60	59.58	8.46	39.75	44.50	63.29	74.00	-10.71	Pk
Vertical	11490.60	40.74	8.46	39.75	44.50	44.45	54.00	-9.55	AV
Vertical	17235.65	40.28	10.12	38.80	44.10	45.10	68.20	-23.10	Pk
Horizontal	5166.60	60.21	5.94	35.18	44.00	57.33	68.20	-10.87	Pk
Horizontal	11490.47	50.51	8.46	38.71	44.50	53.18	74.00	-20.82	Pk
Horizontal	11490.47	39.07	8.46	38.71	44.50	41.74	54.00	-12.26	AV
Horizontal	17235.47	56.95	10.12	38.38	44.10	61.35	68.20	-6.85	Pk
middle Channel (5785 MHz)-Above 1G									
Vertical	5433.40	60.51	6.48	36.35	44.05	59.29	74.00	-14.71	Pk
Vertical	5433.40	40.86	6.48	36.35	44.05	39.64	54.00	-14.36	AV
Vertical	11570.41	60.09	8.47	37.88	44.51	61.93	74.00	-12.07	Pk
Vertical	11570.41	39.74	8.47	37.88	44.51	41.58	54.00	-12.42	AV
Vertical	17355.84	40.64	10.12	38.80	44.10	45.46	68.20	-22.74	Pk
Horizontal	4866.60	59.47	6.48	36.37	44.05	58.27	74.00	-15.73	Pk
Horizontal	4866.60	40.71	6.48	36.37	44.05	39.51	54.00	-14.49	AV
Horizontal	11570.28	59.28	8.47	38.64	44.50	61.89	74.00	-12.11	Pk
Horizontal	11570.28	39.86	8.47	38.64	44.50	42.47	54.00	-11.53	AV
Horizontal	17355.49	50.84	10.12	38.38	44.10	55.24	68.20	-12.96	Pk

High Channel (5825 MHz)-Above 1G									
Vertical	5244.48	59.18	7.10	37.24	43.50	60.02	68.20	-8.18	Pk
Vertical	11652.42	59.29	8.46	37.68	44.50	60.93	74.00	-13.07	Pk
Vertical	11652.42	39.14	8.46	37.68	44.50	40.78	54.00	-13.22	AV
Vertical	17473.74	49.19	10.12	38.80	44.10	54.01	68.20	-14.19	Pk
Horizontal	5285.29	60.00	7.10	37.24	43.50	60.84	68.20	-7.36	Pk
Horizontal	11652.67	60.07	8.46	38.57	44.50	62.60	74.00	-11.40	Pk
Horizontal	11652.67	40.28	8.46	38.57	44.50	42.81	54.00	-11.19	AV
Horizontal	17474.68	49.08	10.12	38.38	44.10	53.48	68.20	-14.72	Pk

Note: "802.11a" mode is the worst mode.

The amplitude of spurious emissions that are attenuated by more than 20dB below the permissible value has no need to be reported.

Emission level (dBuV/m) = 20 log Emission level (uV/m).

Corrected Reading: Antenna Factor + Cable Loss + Read Level - Preamp Factor = Level.

2.2.10 TEST RESULTS (18GHz-40GHz)

EUT :	E-book reader	Model Name. :	M6
Temperature :	20 °C	Relative Humidity :	48%
Pressure :	1010 hPa	Test Voltage :	DC 3.8V
Test Mode :	TX (5.2G)-802.11a 5190MHz~5230MHz; TX (5.3G)-802.11ac40 5270MHz~5310MHz; TX (5.6G)-802.11ac20 5500MHz~5700MHz; TX (5.8G)-802.11 ac40 5755MHz~5795MHz		

All modes have been tested, just the 802.11n20 worst mode has been recorded in the report.

Low Channel (5180 MHz)-Above 1G
Horizontal

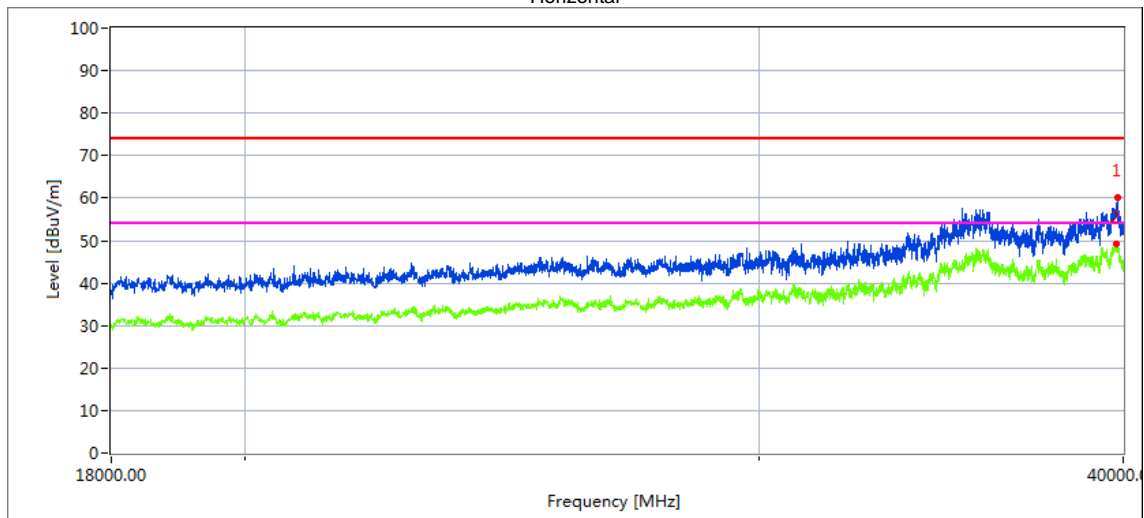

Measurement Result:

Frequency MHz	Meter Reading dBuV	Cable loss dB	Antenna Factor dB/m	Preamp Factor dB	Emission Level dBuV/m	Limits dBuV/m	Margin dB	Detector Type
39769.27	41.46	20.09	44.07	43.48	62.14	68.2	6.06	Peak
39767.19	28.47	20.09	44.04	43.48	49.12	54	4.88	AVG

Vertical

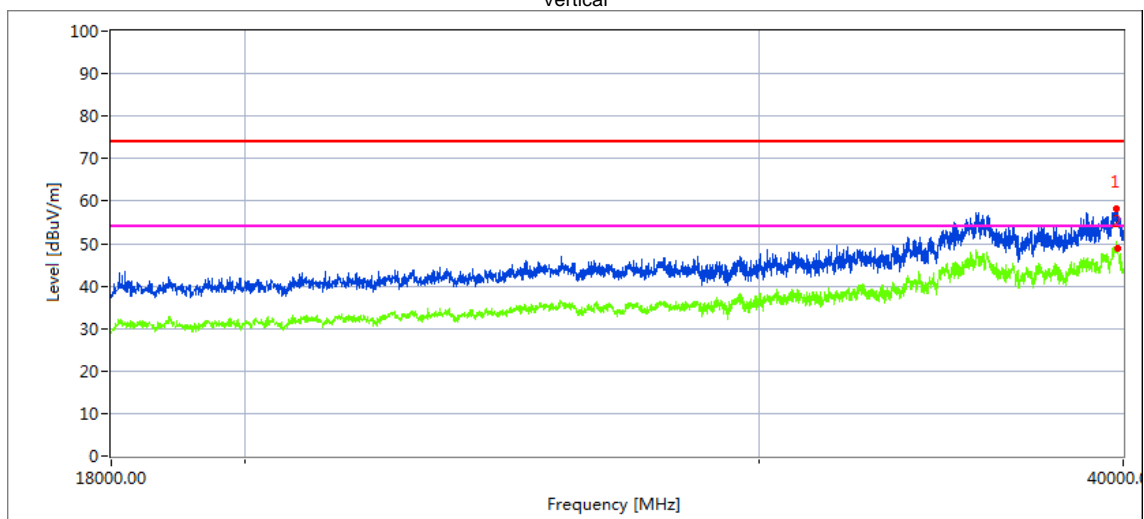

Measurement Result:

Frequency MHz	Meter Reading dBuV	Cable loss dB	Antenna Factor dB/m	Preamp Factor dB	Emission Level dBuV/m	Limits dBuV/m	Margin dB	Detector Type
39769.546	43.60	20.09	44.07	43.48	64.28	68.2	3.92	Peak
39769.365	28.08	20.09	44.04	43.48	48.73	54	5.27	AVG

High Channel (5240 MHz)-Above 1G

Horizontal

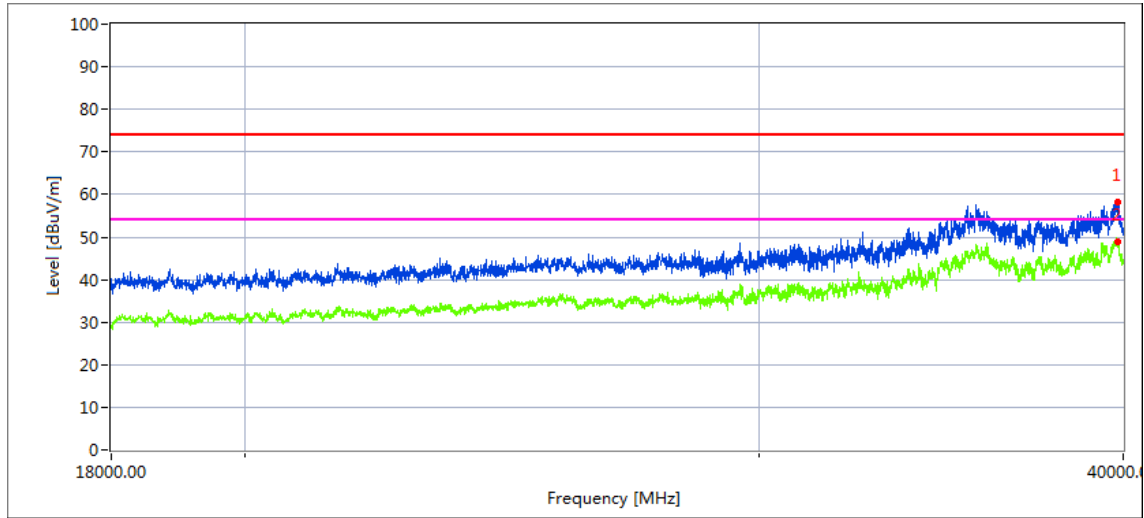

Measurement Result:

Frequency MHz	Meter Reading dBuV	Cable loss dB	Antenna Factor dB/m	Preamp Factor dB	Emission Level dBuV/m	Limits dBuV/m	Margin dB	Detector Type
35628.37	44.59	19.11	42.73	44.61	61.82	68.2	6.38	Peak
35596.986	30.97	19.11	42.73	44.61	48.20	54	5.80	AVG

Vertical

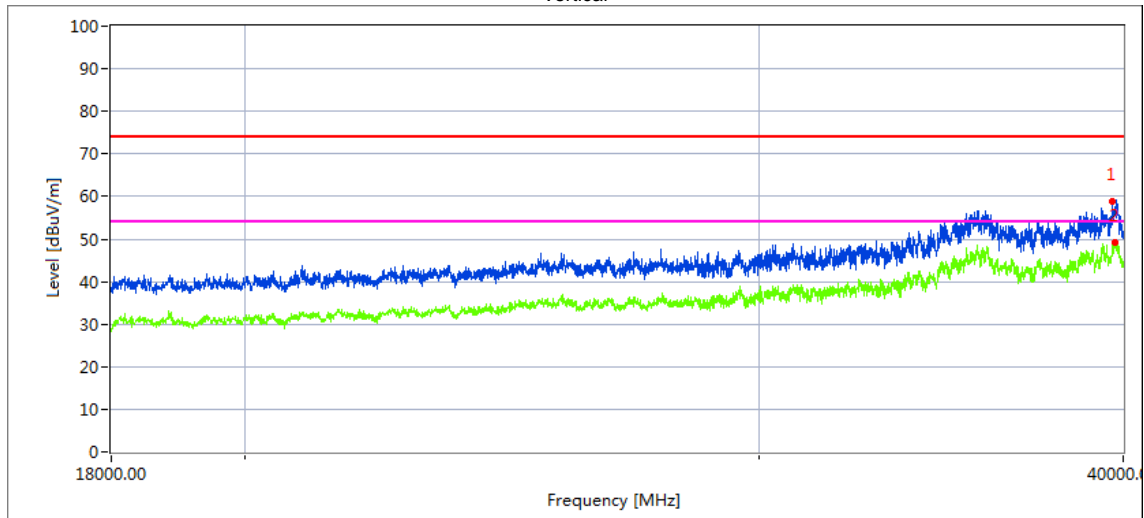

Measurement Result:

Frequency MHz	Meter Reading dBuV	Cable loss dB	Antenna Factor dB/m	Preamp Factor dB	Emission Level dBuV/m	Limits dBuV/m	Margin dB	Detector Type
39769.476	43.37	20.09	44.07	43.48	64.05	68.2	4.15	Peak
39769.476	28.97	20.09	44.04	43.48	49.62	54	4.38	AVG

Low Channel (5270 MHz)-Above 1G

Horizontal

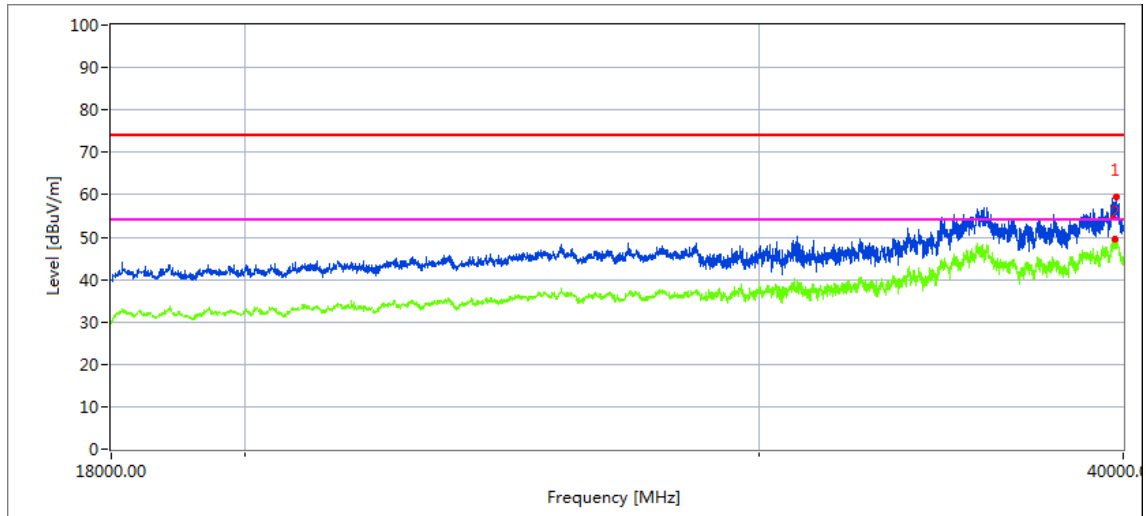

Frequency	Meter Reading	Cable loss	Antenna Factor	Preamp Factor	Emission Level	Limits	Margin	Remark
39176.23	43.71	19.98	43.84	44.62	62.91	68.2	5.29	Peak
39176.23	28.20	19.98	43.84	44.62	47.40	54	6.60	AVG

Vertical

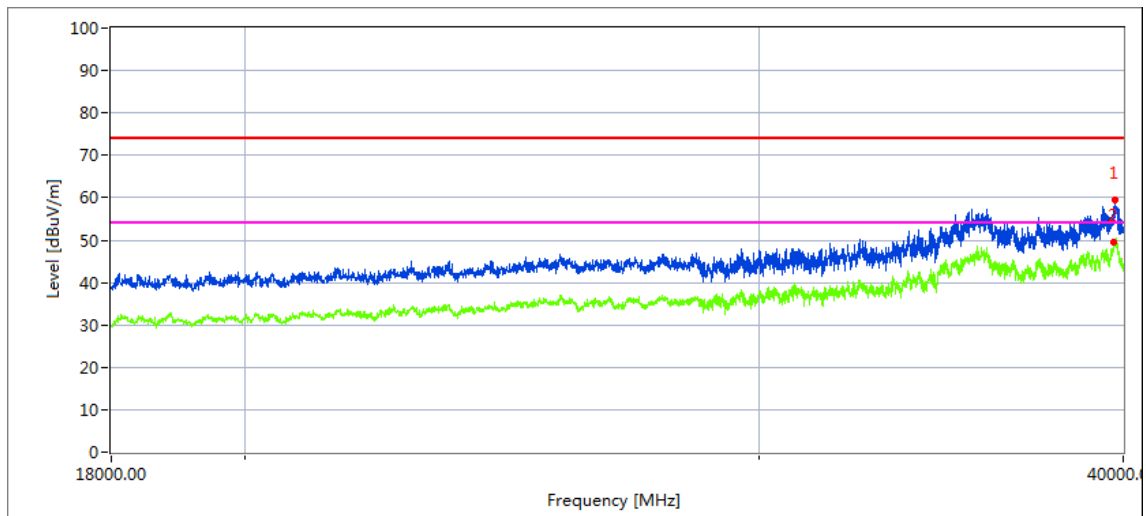

Frequency	Meter Reading	Cable loss	Antenna Factor	Preamp Factor	Emission Level	Limits	Margin	Remark
39385.84	40.93	20.01	44.06	42.69	62.31	68.2	5.89	Peak
39385.84	26.79	20.01	44.06	42.69	48.17	54	5.83	AVG

High Channel (5310 MHz)-Above 1G

Horizontal

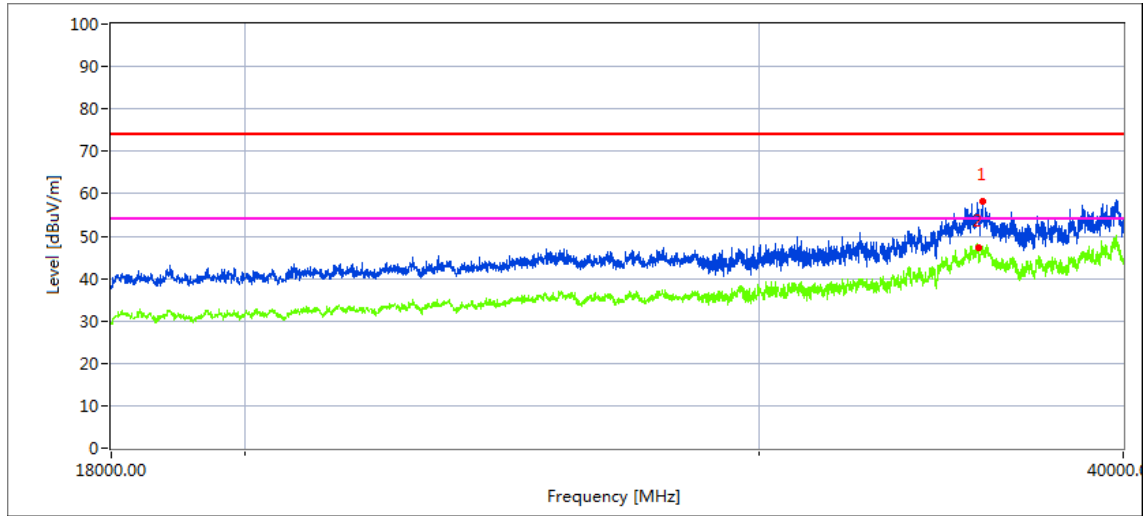

Frequency	Meter Reading	Cable loss	Antenna Factor	Preamp Factor	Emission Level	Limits	Margin	Remark
39176.94	43.13	19.98	43.84	44.62	62.33	68.2	5.87	Peak
39176.94	28.51	19.98	43.84	44.62	47.71	54	6.29	AVG

Vertical

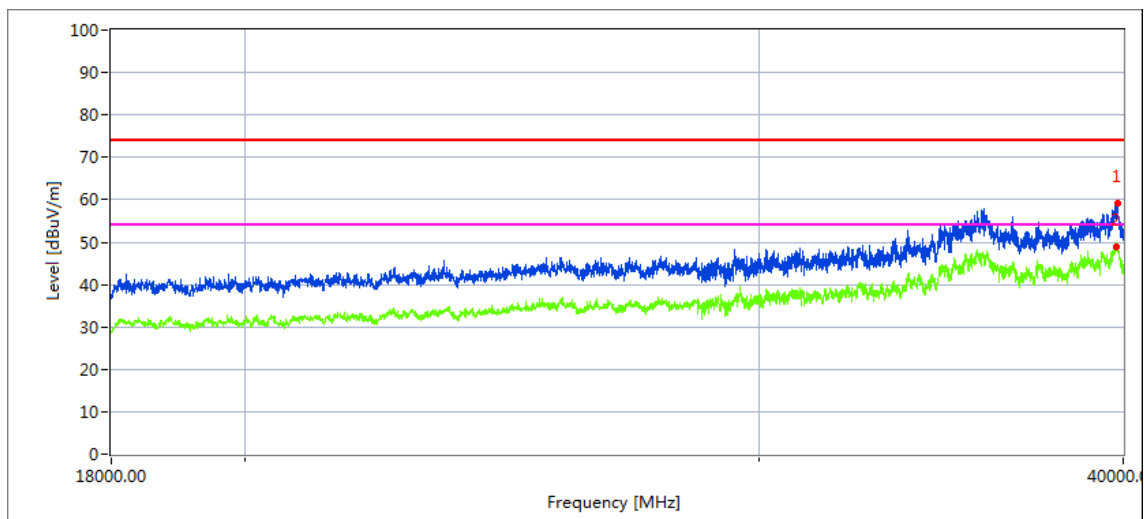

Frequency	Meter Reading	Cable loss	Antenna Factor	Preamp Factor	Emission Level	Limits	Margin	Remark
39369.174	40.09	20.01	44.06	42.69	61.47	68.2	6.73	Peak
39369.174	26.39	20.01	44.06	42.69	47.77	54	6.23	AVG

Low Channel (5500 MHz)-Above 1G

Horizontal

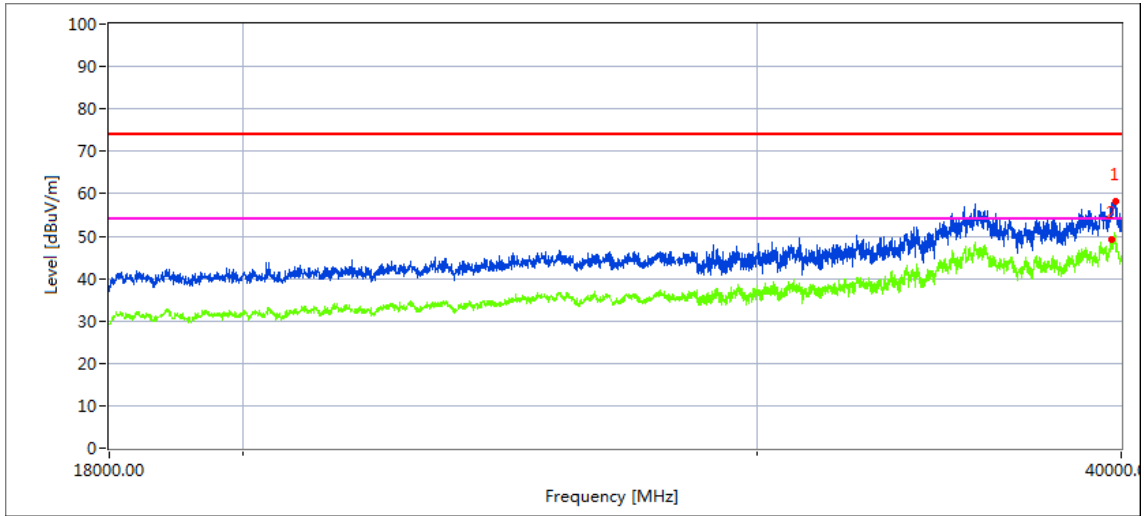

Frequency	Meter Reading	Cable loss	Antenna Factor	Preamp Factor	Emission Level	Limits	Margin	Remark
39696.437	43.98	20.09	44.07	43.48	64.66	68.2	3.54	Peak
39653.181	28.35	20.07	44.06	43.48	49.00	54	5.00	AVG

Vertical

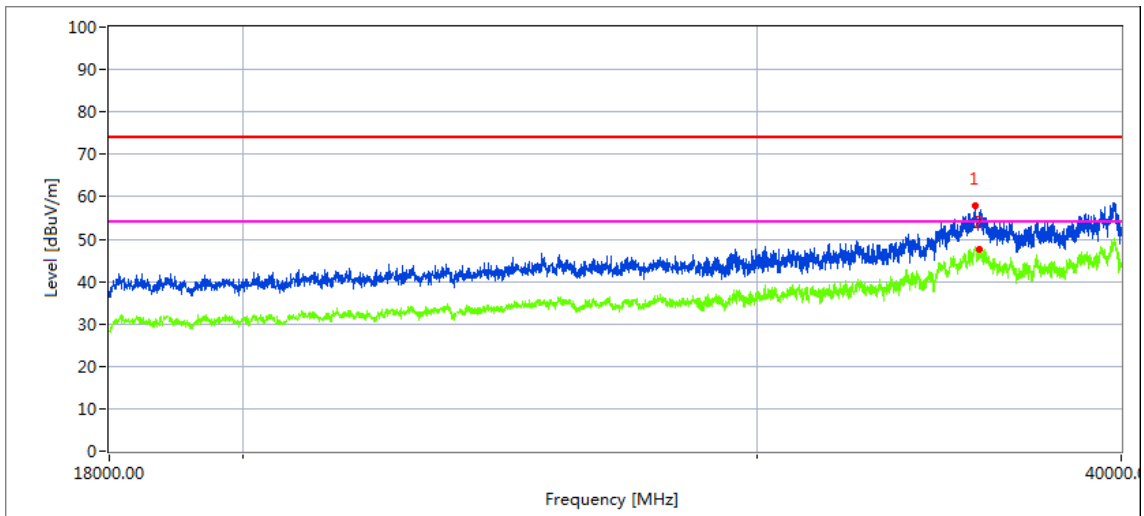

Frequency MHz	Meter Reading dBuV	Cable loss dB	Antenna Factor dB/m	Preamp Factor dB	Emission Level dBuV/m	Limits dBuV/m	Margin dB	Detector Type
36575.641	43.79	19.16	42.61	41.56	64.00	68.2	4.20	Peak
36575.641	28.59	19.16	42.61	41.56	48.80	54	5.20	AVG

High Channel (5700 MHz)-Above 1G

Horizontal

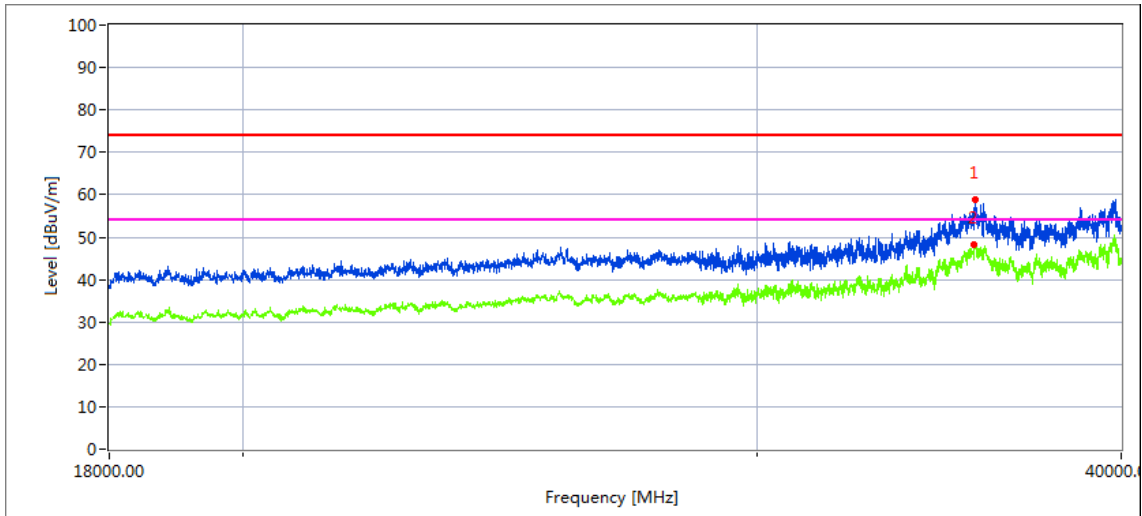

Frequency MHz	Meter Reading dBuV	Cable loss dB	Antenna Factor dB/m	Preamp Factor dB	Emission Level dBuV/m	Limits dBuV/m	Margin dB	Detector Type
35794.5	43.92	19.17	42.63	42.74	62.98	68.2	5.22	Peak
35763.418	28.77	19.14	42.61	42.71	47.81	54	6.19	AVG

Vertical

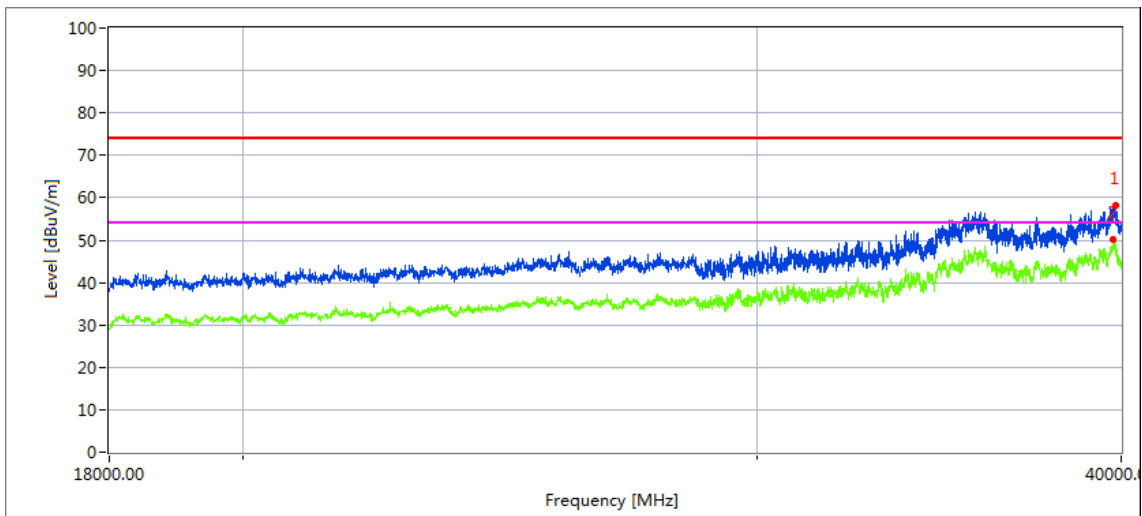

Frequency MHz	Meter Reading dBuV	Cable loss dB	Antenna Factor dB/m	Preamp Factor dB	Emission Level dBuV/m	Limits dBuV/m	Margin dB	Detector Type
39816.733	43.65	20.09	42.63	43.48	62.89	68.2	5.31	Peak
39804.018	28.72	20.09	42.61	43.48	47.94	54	6.06	AVG

Low Channel (5755 MHz)-Above 1G

Horizontal

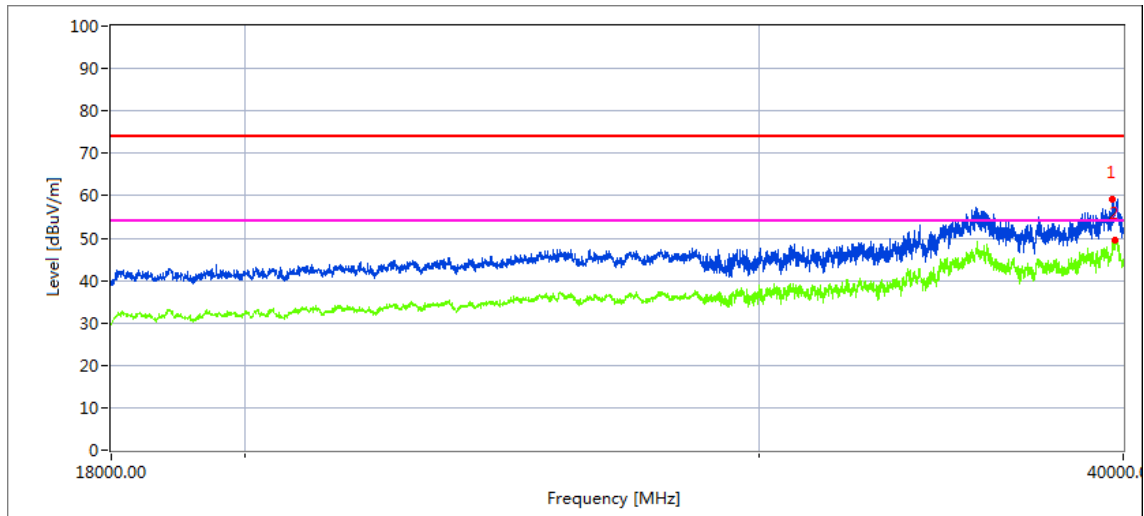

Frequency	Meter Reading	Cable loss	Antenna Factor	Preamp Factor	Emission Level	Limits	Margin	Remark
39670.224	40.32	20.09	44.16	43.48	61.09	68.2	7.11	Peak
39670.224	28.23	20.09	44.16	43.48	49.00	54	5.00	AVG

Vertical

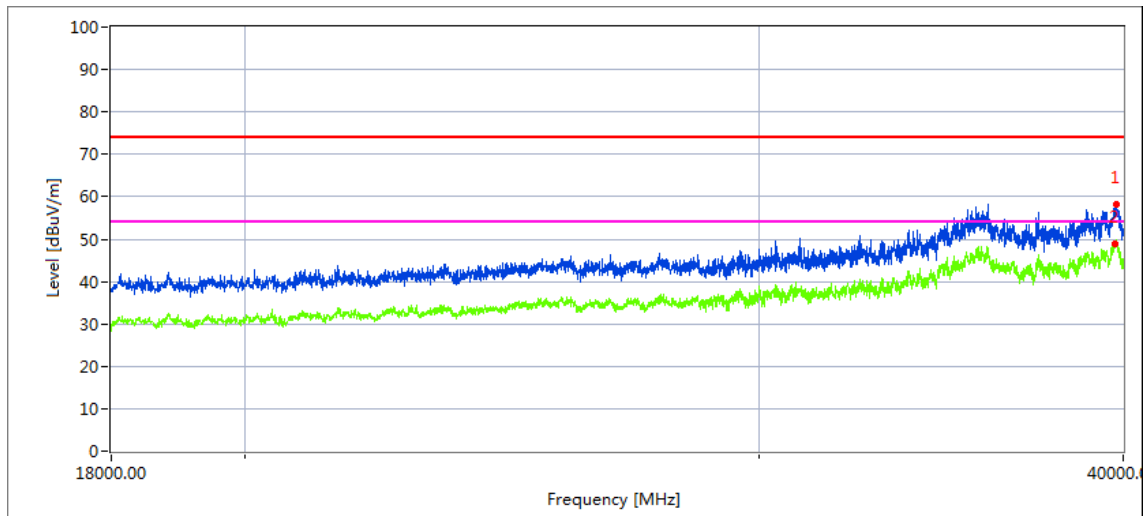

Frequency	Meter Reading	Cable loss	Antenna Factor	Preamp Factor	Emission Level	Limits	Margin	Remark
39731.342	43.26	20.06	44.07	43.21	64.18	68.2	4.02	Peak
39731.342	28.68	20.06	44.07	43.21	49.60	54	4.40	AVG

High Channel (5795 MHz)-Above 1G

Horizontal

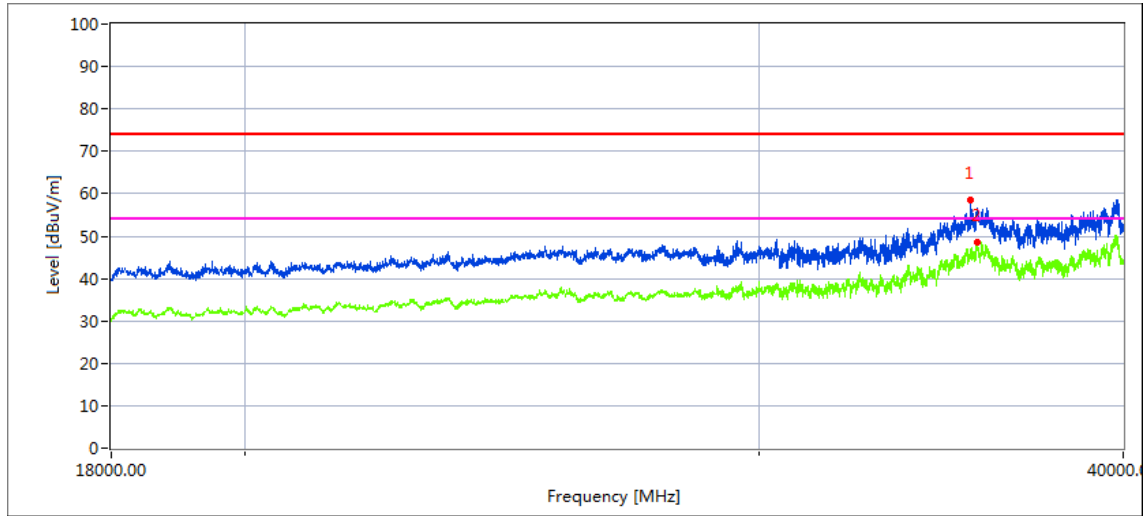

Frequency	Meter Reading	Cable loss	Antenna Factor	Preamp Factor	Emission Level	Limits	Margin	Remark
35628.534	43.12	19.11	42.63	43.48	61.38	68.2	6.82	Peak
35636.158	28.19	19.12	42.63	43.48	46.46	54	7.54	AVG

Vertical

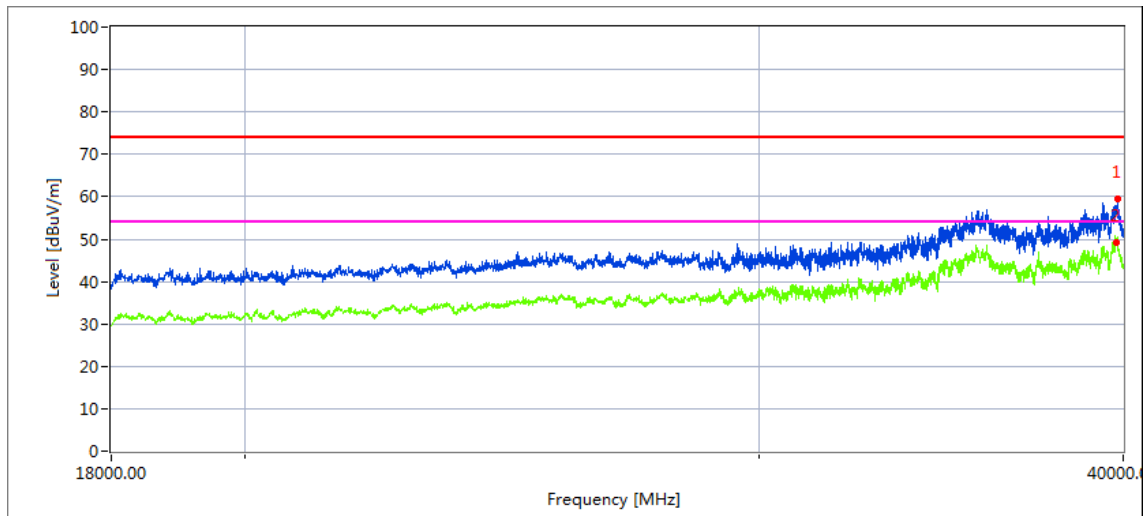

Frequency	Meter Reading	Cable loss	Antenna Factor	Preamp Factor	Emission Level	Limits	Margin	Remark
39821.763	43.99	20.1	44.1	43.22	64.97	68.2	3.23	Peak
39821.763	28.79	20.1	44.1	43.22	49.77	54	4.23	AVG

Note:802.11ac40 mode is the worst mode.

2.2.10 Spurious Emission in Restricted Band 4.5GHz~5.150 GHz& 5.350GHz~5460GHz

EUT :	E-book reader	Model Name. :	M6
Temperature :	20 °C	Relative Humidity :	48%
Pressure :	1010 hPa	Test Voltage :	DC 3.8V
Test Mode :	TX (5.2G)-802.11ac20 5150MHz~5250MHz,		

All the modulation modes have been tested, The report just record the worst data mode.

Frequency	Meter Reading	Cable Loss	Antenna Factor	Preamp Factor	Emission Level	Limits	Margin	Detector	Comment
(MHz)	(dBμV)	(dB)	dB/m	(dB)	(dBμV/m)	(dBμV/m)	(dB)	Type	
5.2G WIFI-802.11a Mode									
4500	62.86	5.2	35.6	44.2	59.46	74	-14.54	Pk	Horizontal
4500	37.01	5.2	35.6	44.2	33.61	54	-20.39	AV	Horizontal
4500	62.65	5.2	35.6	44.2	59.25	74	-14.75	Pk	Horizontal
4500	33.48	5.2	35.6	44.2	30.08	54	-23.92	AV	Horizontal
5150	62.87	5.36	35.66	44.22	59.67	74	-14.33	Pk	Horizontal
5150	33.38	5.36	35.66	44.22	30.18	54	-23.82	AV	Horizontal
5150	63.36	5.36	35.66	44.22	60.16	74	-13.84	Pk	Vertical
5150	42.39	5.36	35.66	44.22	39.19	54	-14.81	AV	Vertical
5350	62.20	5.68	35.68	44.22	59.34	74	-14.66	Pk	Vertical
5350	33.71	5.68	35.68	44.22	30.85	54	-23.15	AV	Vertical
5350	62.32	5.68	35.68	44.22	59.46	74	-14.54	Pk	Horizontal
5350	37.26	5.68	35.68	44.22	34.40	54	-19.60	AV	Horizontal

Note: (1) Emission Level= Antenna Factor + Cable Loss + Read Level - Preamp Factor

(2) "802.11ac20" mode is the worst mode. When PK value is lower than the Average value limit, average don't record.

EUT :	E-book reader	Model Name. :	M6
Temperature :	20 °C	Relative Humidity :	48%
Pressure :	1010 hPa	Test Voltage :	DC 3.8V
Test Mode :	TX (5.3G)-802.11ac40 5250MHz~5350MHz,		

All the modulation modes have been tested, The report just record the worst data mode.

Polar	Frequency	Meter Reading	Cable loss	Antenna Factor	Preamp Factor	Emission Level	Limits	Margin	Detector Type
(H/V)	(MHz)	(dBuV)	(dB)	dB/m	(dB)	(dBuV/m)	(dBuV/m)	(dB)	
High Channel (5320 MHz)-Above 1G									
Vertical	5350.00	66.27	6.96	37.24	43.50	66.97	74.00	-7.03	Pk
Vertical	5350.00	47.24	7.07	37.24	43.50	48.05	54.00	-5.95	AV
Horizontal	5350.00	66.23	7.05	37.24	43.50	67.02	74.00	-6.98	Pk
Horizontal	5350.00	42.85	7.05	37.24	43.50	43.64	54.00	-10.36	AV

Note: (1) Emission Level= Antenna Factor + Cable Loss + Read Level - Preamp Factor

(2) "802.11ac40 " mode is the worst mode. When PK value is lower than the Average value limit, average don't record.

EUT :	E-book reader	Model Name. :	M6
Temperature :	20 °C	Relative Humidity :	48%
Pressure :	1010 hPa	Test Voltage :	DC 3.8V
Test Mode :	TX (5.6G)-802.11ac20 5470MHz~5725MHz,		

All the modulation modes have been tested, The report just record the worst data mode.

Polar	Frequency	Meter Reading	Cable loss	Antenna Factor	Preamp Factor	Emission Level	Limits	Margin	Detector Type
(H/V)	(MHz)	(dBuV)	(dB)	dB/m	(dB)	(dBuV/m)	(dBuV/m)	(dB)	
Low Channel (5500 MHz)-Above 1G									
Vertical	5460.00	67.77	5.61	35.40	44.00	64.78	74.00	-9.22	Pk
Vertical	5460.00	47.06	5.76	35.40	44.00	44.22	54.00	-9.78	AV
Horizontal	5460.00	66.22	5.78	35.18	44.00	63.18	74.00	-10.82	Pk
Horizontal	5460.00	42.70	5.66	35.18	44.00	39.55	54.00	-14.45	AV

Note: (1) Emission Level= Antenna Factor + Cable Loss + Read Level - Preamp Factor

(2) "802.11ac20 " mode is the worst mode. When PK value is lower than the Average value limit, average don't record.

3. POWER SPECTRAL DENSITY TEST

3.1 APPLIED PROCEDURES / LIMIT

According to FCC §15.407(a)

For the band 5.15-5.25 GHz,

(i) For an outdoor access point operating in the band 5.15-5.25 GHz, the maximum power spectral density shall not exceed 17 dBm in any 1 megahertz band. If transmitting antennas of directional gain greater than 6 dBi are used, both the maximum conducted output power and the maximum power spectral density shall be reduced by the amount in dB that the directional gain of the antenna exceeds 6 dBi. The maximum e.i.r.p. at any elevation angle above 30 degrees as measured from the horizon must not exceed 125 mW (21 dBm).

(ii) For an indoor access point operating in the band 5.15-5.25 GHz, the maximum power spectral density shall not exceed 17 dBm in any 1 megahertz band. If transmitting antennas of directional gain greater than 6 dBi are used, both the maximum conducted output power and the maximum power spectral density shall be reduced by the amount in dB that the directional gain of the antenna exceeds 6 dBi.

(iii) For fixed point-to-point access points operating in the band 5.15-5.25 GHz, the maximum power spectral density shall not exceed 17 dBm in any 1 megahertz band. Fixed point-to-point U-NII devices may employ antennas with directional gain up to 23 dBi without any corresponding reduction in the maximum conducted output power or maximum power spectral density. For fixed point-to-point transmitters that employ a directional antenna gain greater than 23 dBi, a 1 dB reduction in maximum conducted output power and maximum power spectral density is required for each 1 dB of antenna gain in excess of 23 dBi. Fixed, point-to-point operations exclude the use of point-to-multipoint systems, omnidirectional applications, and multiple collocated transmitters transmitting the same information. The operator of the U-NII device, or if the equipment is professionally installed, the installer, is responsible for ensuring that systems employing high gain directional antennas are used exclusively for fixed, point-to-point operations.

(iv) For client devices in the 5.15-5.25 GHz band, the maximum power spectral density shall not exceed 11 dBm in any 1 megahertz band. If transmitting antennas of directional gain greater than 6 dBi are used, both the maximum conducted output power and the maximum power spectral density shall be reduced by the amount in dB that the directional gain of the antenna exceeds 6 dBi.

For the 5.25-5.35 GHz and 5.47-5.725 GHz bands, the maximum conducted output power over the frequency bands of operation shall not exceed the lesser of 250 mW or $11 \text{ dBm} + 10 \log B$, where B is the 26 dB emission bandwidth in megahertz. In addition, the maximum power spectral density shall not exceed 11 dBm in any 1 megahertz band. If transmitting antennas of directional gain greater than 6 dBi are used, both the maximum conducted output power and the maximum power spectral density shall be reduced by the amount in dB that the directional gain of the antenna exceeds 6 dBi.

For the band 5.725-5.85 GHz

(3) For the band 5.725-5.85 GHz, the maximum power spectral density shall not exceed 30 dBm in any 500-kHz band. If transmitting antennas of directional gain greater than 6 dBi are used, both the maximum conducted output power and the maximum power spectral density shall be reduced by the amount in dB that the directional gain of the antenna exceeds 6 dBi.

,

3.2 TEST PROCEDURE

For devices operating in the bands 5.15-5.25 GHz, 5.25-5.35 GHz, and 5.47-5.725 GHz, the above procedures make use of 1 MHz RBW to satisfy directly the 1 MHz reference bandwidth specified in § 15.407(a)(5). For devices operating in the band 5.725-5.85 GHz, the rules specify a measurement bandwidth of 500 kHz. Many spectrum analyzers do not have 500 kHz RBW, thus a narrower RBW may need to be used. The rules permit the use of a RBWs less than 1 MHz, or 500 kHz, “provided that the measured power is integrated over the full reference bandwidth” to show the total power over the specified measurement bandwidth (i.e., 1 MHz, or 500 kHz). If measurements are performed using a reduced resolution bandwidth (< 1 MHz, or < 500 kHz) and integrated over 1 MHz, or 500 KHz bandwidth, the following adjustments to the procedures apply:

- a) Set $RBW \geq 1/T$, where T is defined in section II.B.I.a).
- b) Set $VBW \geq 3 RBW$.
- c) If measurement bandwidth of Maximum PSD is specified in 500 kHz, add $10\log(500\text{kHz}/RBW)$ to the measured result, whereas $RBW (< 500 \text{ KHz})$ is the reduced resolution bandwidth of the spectrum analyzer set during measurement.
- d) If measurement bandwidth of Maximum PSD is specified in 1 MHz, add $10\log(1\text{MHz}/RBW)$ to the measured result, whereas $RBW (< 1 \text{ MHz})$ is the reduced resolution bandwidth of spectrum analyzer set during measurement.
- e) Care must be taken to ensure that the measurements are performed during a period of continuous transmission or are corrected upward for duty cycle.

Note: As a practical matter, it is recommended to use reduced RBW of 100 KHz for the sections 5.c) and 5.d) above, since $RBW=100 \text{ KHz}$ is available on nearly all spectrum analyzers.

3.3 DEVIATION FROM STANDARD

No deviation.

3.4 TEST SETUP

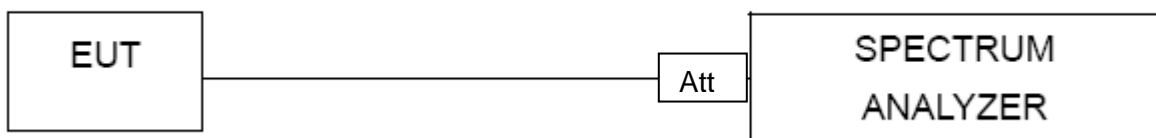

3.5 EUT OPERATION CONDITIONS

The EUT tested system was configured as the statements of 2.1 Unless otherwise a special operating condition is specified in the follows during the testing.

3.6 TEST RESULTS

EUT :	E-book reader	Model Name :	M6
Temperature :	26 °C	Relative Humidity :	54%
Pressure :	1015 hPa	Test Voltage :	DC 3.8V
Test Mode :	TX Frequency Band 1 (5150-5250MHz), Band 2A (5250-5350MHz), Band 2C (5470-5725MHz), Band 3 (5745-5825MHz)		

Test data reference attachment.

4. 26DB & 99% EMISSION BANDWIDTH

4.1 APPLIED PROCEDURES / LIMIT

The maximum power spectral density is measured as a conducted emission by direct connection of a calibrated test instrument to the equipment under test. If the device cannot be connected directly, alternative techniques acceptable to the Commission may be used. Measurements in the 5.725-5.85 GHz band are made over a reference bandwidth of 500 kHz or the 26 dB emission bandwidth of the device, whichever is less. Measurements in the 5.15-5.25 GHz, 5.25-5.35 GHz, and the 5.47-5.725 GHz bands are made over a bandwidth of 1 MHz or the 26 dB emission bandwidth of the device, whichever is less. A narrower resolution bandwidth can be used, provided that the measured power is integrated over the full reference bandwidth.

4.2 TEST PROCEDURE

- a) Set RBW = approximately 1% of the emission bandwidth.
- b) Set the VBW > RBW.
- c) Detector = Peak.
- d) Trace mode = max hold.
- e) Measure the maximum width of the emission that is 26 dB down from the maximum of the emission. Compare this with the RBW setting of the analyzer. Readjust RBW and repeat measurement as needed until the RBW/EBW ratio is approximately 1%.

The following procedure shall be used for measuring (99 %) power bandwidth:

1. Set center frequency to the nominal EUT channel center frequency.
2. Set span = 1.5 times to 5.0 times the OBW.
3. Set RBW = 1 % to 5 % of the OBW
4. Set VBW $\geq 3 \cdot$ RBW
5. Video averaging is not permitted. Where practical, a sample detection and single sweep mode shall be used. Otherwise, peak detection and max hold mode (until the trace stabilizes) shall be used.
6. Use the 99 % power bandwidth function of the instrument (if available).
7. If the instrument does not have a 99 % power bandwidth function, the trace data points are recovered and directly summed in power units. The recovered amplitude data points, beginning at the lowest frequency, are placed in a running sum until 0.5 % of the total is reached; that frequency is recorded as the lower frequency. The process is repeated until 99.5 % of the total is reached; that frequency is recorded as the upper frequency. The 99% occupied bandwidth is the difference between these two frequencies.

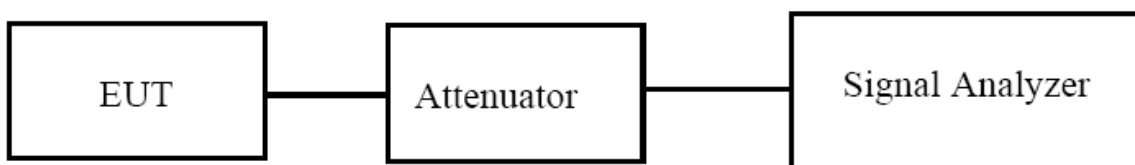

4.3 EUT OPERATION CONDITIONS

The EUT tested system was configured as the statements of 2.4 Unless otherwise a special operating condition is specified in the follows during the testing.

4.4 TEST RESULTS

EUT :	E-book reader	Model Name :	M6
Temperature :	26 °C	Relative Humidity :	54%
Pressure :	1012 hPa	Test Voltage :	DC 3.8V
Test Mode :	TX Frequency Band 1 (5150-5250MHz), Band 2A (5250-5350MHz), Band 2C(5470-5725MHz), Band 3(5725-5850MHz)		

Test data reference attachment.

5. MINIMUM 6 DB BANDWIDTH

5.1 APPLIED PROCEDURES / LIMIT

According to FCC §15.407(e)

(e) Within the 5.725-5.85 GHz band, the minimum 6 dB bandwidth of U-NII devices shall be at least 500 kHz.

5.2 TEST PROCEDURE

Section 15.407(e) specifies the minimum 6 dB emission bandwidth of at least 500 KHz for the band 5.715-5.85 GHz. The following procedure shall be used for measuring this bandwidth:

- a) Set RBW = 100 kHz.
- b) Set the video bandwidth (VBW) $\geq 3 \times$ RBW.
- c) Detector = Peak.
- d) Trace mode = max hold.
- e) Sweep = auto couple.
- f) Allow the trace to stabilize.
- g) Measure the maximum width of the emission that is constrained by the frequencies associated with the two outermost amplitude points (upper and lower frequencies) that are attenuated by 6 dB relative to the maximum level measured in the fundamental emission.

5.3 DEVIATION FROM STANDARD

No deviation.

5.4 TEST SETUP

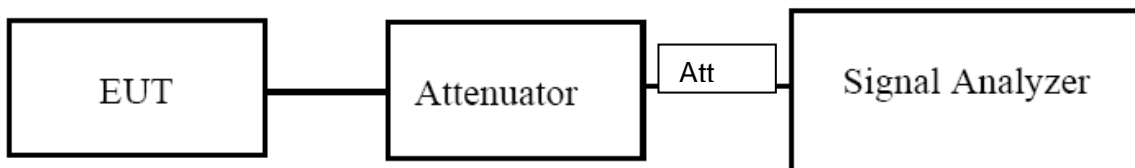

5.5 EUT OPERATION CONDITIONS

The EUT tested system was configured as the statements of 2.4 Unless otherwise a special operating condition is specified in the follows during the testing.

5.6 TEST RESULTS

EUT :	E-book reader	Model Name :	M6
Temperature :	26 °C	Relative Humidity :	54%
Pressure :	1012 hPa	Test Voltage :	DC 3.8V
Test Mode :	TX (5G) Mode Frequency Band 3 (5725-5850MHz)		

Test data reference attachment.

6. MAXIMUM CONDUCTED OUTPUT POWER

6.1 PPLIED PROCEDURES / LIMIT

According to FCC §15.407

The maximum conduced output power should not exceed:

Frequency Band(MHz)	Limit
5150~5250	250mW
5250~5350	250 mW or 11 dBm + 10 log B Note: The limit is the smaller of the two, "B" represents -26dB bandwidth.
5470~5725	250 mW or 11 dBm + 10 log B Note: The limit is the smaller of the two, "B" represents -26dB bandwidth.
5725~5850	1W

6.2 TEST PROCEDURE

- Method PM is Measurement using an RF average power meter. The procedure for this method is as follows:
 - a) Measurements may be performed using a wideband RF power meter with a thermocouple detector or equivalent if all of the following conditions are satisfied:
 - 1) The EUT is configured to transmit continuously, or to transmit with a constant duty cycle.
 - 2) At all times when the EUT is transmitting, it shall be transmitting at its maximum power control level.
 - 3) The integration period of the power meter exceeds the repetition period of the transmitted signal by at least a factor of five.
 - b) If the transmitter does not transmit continuously, measure the duty cycle D of the transmitter output signal as described in 12.2.
 - c) Measure the average power of the transmitter. This measurement is an average over both the ON and OFF periods of the transmitter.
 - d) Adjust the measurement in dBm by adding $[10 \log (1 / D)]$, where D is the duty cycle {e.g., $[10 \log (1 / 0.25)]$, if the duty cycle is 25%}.

6.3 DEVIATION FROM STANDARD

No deviation.

6.4 TEST SETUP

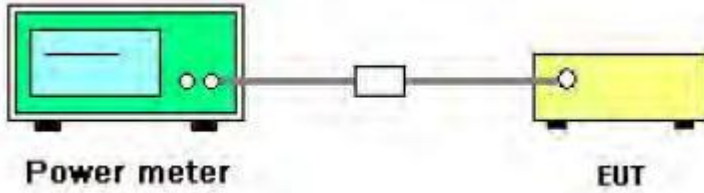

6.5 EUT OPERATION CONDITIONS

The EUT tested system was configured as the statements of 2.4 Unless otherwise a special operating condition is specified in the follows during the testing.

6.2 TEST RESULTS

EUT :	E-book reader	Model Name :	M6
Temperature :	26 °C	Relative Humidity :	54%
Pressure :	1012 hPa	Test Voltage :	DC 3.8V
Test Mode :	TX (5G) Mode Frequency Band 1 (5150-5250MHz), Band 2A (5250-5350MHz) Band 2C, (5470-5725MHz), Band 3 (5725-5850MHz)		

Test data reference attachment.

7. OUT OF BAND EMISSIONS

7.1 APPLICABLE STANDARD

According to FCC §15.407(b)

Undesirable emission limits. Except as shown in paragraph (b)(7) of this section, the maximum emissions outside of the frequency bands of operation shall be attenuated in accordance with the following limits:

- (1) For transmitters operating in the 5.15-5.25 GHz band: All emissions outside of the 5.15-5.35 GHz band shall not exceed an e.i.r.p. of -27 dBm/MHz.
- (2) For transmitters operating in the 5.25-5.35 GHz band: All emissions outside of the 5.15-5.35 GHz band shall not exceed an e.i.r.p. of -27 dBm/MHz.
- (3) For transmitters operating in the 5.47-5.725 GHz band: All emissions outside of the 5.47-5.725 GHz band shall not exceed an e.i.r.p. of -27 dBm/MHz.
- (4) For transmitters operating in the 5.725-5.85 GHz band:
 - (i) All emissions shall be limited to a level of -27 dBm/MHz at 75 MHz or more above or below the band edge increasing linearly to 10 dBm/MHz at 25 MHz above or below the band edge, and from 25 MHz above or below the band edge increasing linearly to a level of 15.6 dBm/MHz at 5 MHz above or below the band edge, and from 5 MHz above or below the band edge increasing linearly to a level of 27 dBm/MHz at the band edge.
 - (ii) Devices certified before March 2, 2017 with antenna gain greater than 10 dBi may demonstrate compliance with the emission limits in §15.247(d), but manufacturing, marketing and importing of devices certified under this alternative must cease by March 2, 2018. Devices certified before March 2, 2018 with antenna gain of 10 dBi or less may demonstrate compliance with the emission limits in §15.247(d), but manufacturing, marketing and importing of devices certified under this alternative must cease before March 2, 2020.

7.2 TEST PROCEDURE

1. Check the calibration of the measuring instrument using either an internal calibrator or a known signal from an external generator.
2. Position the EUT without connection to measurement instrument. Turn on the EUT and connect its antenna terminal to measurement instrument via a low loss cable. Then set it to any one measured frequency within its operating range, and make sure the instrument is operated in its linear range.
3. Set RBW of spectrum analyzer to 1 MHz with a convenient frequency span.
4. Measure the highest amplitude appearing on spectral display and set it as a reference level. Plot

the graph with marking the highest point and edge frequency.

5. Repeat above procedures until all measured frequencies were complete.

7.3 DEVIATION FROM STANDARD

No deviation.

7.4 TEST SETUP

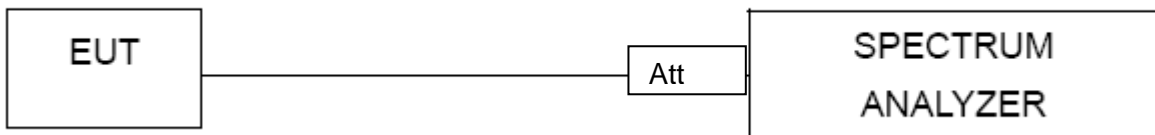

7.5 EUT OPERATION CONDITIONS

The EUT tested system was configured as the statements of 2.4 Unless otherwise a special operating condition is specified in the follows during the testing.

7.6 TEST RESULTS

EUT :	E-book reader	Model Name :	M6
Temperature :	26 °C	Relative Humidity :	54%
Pressure :	1012 hPa	Test Voltage :	DC 3.8V

Test data reference attachment.

8. Frequency Stability Measurement

8.1 LIMIT

Manufactures of U-NII devices are responsible for ensuring frequency stability such that an emission is maintained within the band of operation under all conditions of normal operation as specified in the user's manual.

8.2 TEST PROCEDURES

1. The transmitter output (antenna port) was connected to the spectrum analyzer.
2. EUT have transmitted absence of modulation signal and fixed channelize.
3. Set the spectrum analyzer span to view the entire absence of modulation emissions bandwidth.
4. Set RBW = 10 kHz, VBW = 10 kHz with peak detector and maxhold settings.
5. f_c is declaring of channel frequency. Then the frequency error formula is $(f_c - f) / f_c \times 10^6$ ppm and the limit is less than ± 20 ppm (IEEE 802.11 specification).
6. The test extreme voltage is to change the primary supply voltage from 85 to 115 percent of the nominal value
7. Extreme temperature is $-20^{\circ}\text{C} \sim 70^{\circ}\text{C}$.

8.3 TEST SETUP LAYOUT

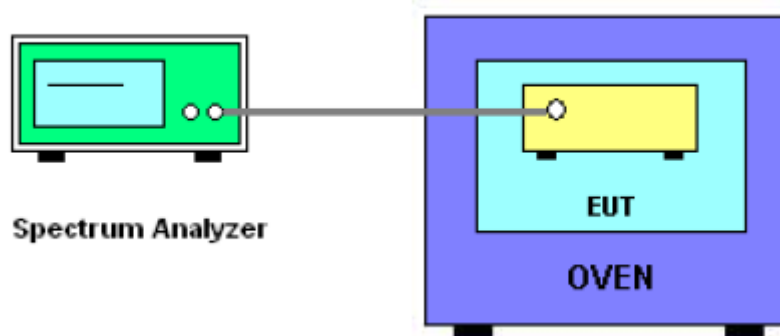

8.4 EUT OPERATION DURING TEST

1. The EUT was programmed to be in continuously un-modulation transmitting mode.

8.5 TEST RESULTS

EUT :	E-book reader	Model Name. :	M6
Temperature :	25 °C	Relative Humidity :	56%
Pressure :	1012 hPa	Test Voltage :	DC 3.8V
Test Mode :	TX Frequency Band I (5150-5250MHz)		

Voltage vs. Frequency Stability

TEST CONDITIONS				Reference Frequency: 5180MHz			
				f	fc	Max. Deviation (MHz)	Max. Deviation (ppm)
T nom (°C)	20	V nom (V)	3.8	5180.0005	5180	0.0005	-0.0926
		V max (V)	4.2	5180.0056	5180	0.0056	-1.0849
		V min (V)	3.4	5180.0026	5180	0.0026	-0.5040
Limits				Within 5150-5250MHz			
Result				Complies			

Temperature vs. Frequency Stability

TEST CONDITIONS				Reference Frequency: 5180MHz			
				f	fc	Max. Deviation (MHz)	Max. Deviation (ppm)
V nom (V)	3.8	T (°C)	-20	5180.0061	5180	0.0061	-1.1683
		T (°C)	-10	5180.0045	5180	0.0045	-0.8708
		T (°C)	0	5180.0068	5180	0.0068	-1.3208
		T (°C)	10	5180.0023	5180	0.0023	-0.4506
		T (°C)	20	5180.0061	5180	0.0061	-1.1689
		T (°C)	30	5180.0081	5180	0.0081	-1.5636
		T (°C)	40	5180.0089	5180	0.0089	-1.7189
		T (°C)	50	5180.0003	5180	0.0003	-0.0574
		T (°C)	60	5180.0072	5180	0.0072	-1.3957
		T (°C)	70	5180.0010	5180	0.0010	-0.1917
Limits				Within 5150-5250MHz			
Result				Complies			

Voltage vs. Frequency Stability

TEST CONDITIONS				Reference Frequency: 5200MHz			
				f	fc	Max. Deviation (MHz)	Max. Deviation (ppm)
T nom (°C)	20	V nom (V)	3.8	5200.0012	5200	0.0012	-0.2283
		V max (V)	4.2	5200.0081	5200	0.0081	-1.5607
		V min (V)	3.4	5200.0033	5200	0.0033	-0.6371
Limits				Within 5150-5250MHz			
Result				Complies			

Temperature vs. Frequency Stability

TEST CONDITIONS				Reference Frequency: 5200MHz			
				f	fc	Max. Deviation (MHz)	Max. Deviation (ppm)
V nom (V)	3.8	T (°C)	-20	5200.0094	5200	0.0094	-1.8107
		T (°C)	-10	5200.0021	5200	0.0021	-0.4109
		T (°C)	0	5200.0072	5200	0.0072	-1.3832
		T (°C)	10	5200.0047	5200	0.0047	-0.8993
		T (°C)	20	5200.0083	5200	0.0083	-1.5922
		T (°C)	30	5200.0025	5200	0.0025	-0.4743
		T (°C)	40	5200.0031	5200	0.0031	-0.5961
		T (°C)	50	5200.0077	5200	0.0077	-1.4804
		T (°C)	60	5200.0026	5200	0.0026	-0.5009
		T (°C)	70	5200.0073	5200	0.0073	-1.4010
Limits				Within 5150-5250MHz			
Result				Complies			

Voltage vs. Frequency Stability

TEST CONDITIONS				Reference Frequency: 5240MHz			
				f	fc	Max. Deviation (MHz)	Max. Deviation (ppm)
T nom (°C)	20	V nom (V)	3.8	5240.0009	5240	0.0009	-0.1622
		V max (V)	4.2	5240.0034	5240	0.0034	-0.6517
		V min (V)	3.4	5240.0076	5240	0.0076	-1.4478
Limits				Within 5150-5250MHz			
Result				Complies			

Temperature vs. Frequency Stability

TEST CONDITIONS				Reference Frequency: 5240MHz			
				f	fc	Max. Deviation (MHz)	Max. Deviation (ppm)
V nom (V)	3.8	T (°C)	-20	5240.0006	5240	0.0006	-0.1170
		T (°C)	-10	5240.0079	5240	0.0079	-1.5062
		T (°C)	0	5240.0055	5240	0.0055	-1.0525
		T (°C)	10	5240.0060	5240	0.0060	-1.1432
		T (°C)	20	5240.0016	5240	0.0016	-0.3000
		T (°C)	30	5240.0024	5240	0.0024	-0.4540
		T (°C)	40	5240.0007	5240	0.0007	-0.1281
		T (°C)	50	5240.0043	5240	0.0043	-0.8137
		T (°C)	60	5240.0081	5240	0.0081	-1.5380
		T (°C)	70	5240.0005	5240	0.0005	-0.0932
Limits				Within 5150-5250MHz			
Result				Complies			

EUT :	E-book reader	Model Name. :	M6
Temperature :	25 °C	Relative Humidity :	56%
Pressure :	1012 hPa	Test Voltage :	DC 3.8V
Test Mode :	TX Frequency Band 2A (5250-5350MHz)		

Voltage vs. Frequency Stability

TEST CONDITIONS				Reference Frequency: 5260MHz			
				f	fc	Max. Deviation (MHz)	Max. Deviation (ppm)
T nom (°C)	20	V nom (V)	3.8	5260.0039	5260	0.00394	-0.7487
		V max (V)	4.2	5260.0088	5260	0.00882	-1.6761
		V min (V)	3.4	5260.0041	5260	0.00406	-0.7724
Limits				Within 5250-5350MHz			
Result				Complies			

Temperature vs. Frequency Stability

TEST CONDITIONS				Reference Frequency: 5260MHz			
				f	fc	Max. Deviation (MHz)	Max. Deviation (ppm)
V nom (V)	3.8	T (°C)	-20	5260.0037	5260	0.00375	-0.7125
		T (°C)	-10	5260.0060	5260	0.00597	-1.1345
		T (°C)	0	5260.0044	5260	0.00438	-0.8336
		T (°C)	10	5260.0031	5260	0.00309	-0.5872
		T (°C)	20	5260.0071	5260	0.00713	-1.3554
		T (°C)	30	5260.0034	5260	0.00339	-0.6442
		T (°C)	40	5260.0030	5260	0.00299	-0.5689
		T (°C)	50	5260.0087	5260	0.00874	-1.6625
		T (°C)	60	5260.0077	5260	0.00768	-1.4596
		T (°C)	70	5260.0023	5260	0.00228	-0.4336
Limits				Within 5250-5350MHz			
Result				Complies			

Voltage vs. Frequency Stability

TEST CONDITIONS				Reference Frequency: 5280MHz			
				f	fc	Max. Deviation (MHz)	Max. Deviation (ppm)
T nom (°C)	20	V nom (V)	3.8	5280.0084	5280	0.00844	-1.5993
		V max (V)	4.2	5280.0054	5280	0.00539	-1.0212
		V min (V)	3.4	5280.0025	5280	0.00253	-0.4791
Limits				Within 5250-5350MHz			
Result				Complies			

Temperature vs. Frequency Stability

TEST CONDITIONS				Reference Frequency: 5280MHz			
				f	fc	Max. Deviation (MHz)	Max. Deviation (ppm)
V nom (V)	3.8	T (°C)	-20	5280.0007	5280	0.00070	-0.1331
		T (°C)	-10	5280.0037	5280	0.00373	-0.7058
		T (°C)	0	5280.0025	5280	0.00248	-0.4698
		T (°C)	10	5280.0070	5280	0.00700	-1.3264
		T (°C)	20	5280.0039	5280	0.00388	-0.7344
		T (°C)	30	5280.0027	5280	0.00270	-0.5120
		T (°C)	40	5280.0000	5280	0.00002	-0.0041
		T (°C)	50	5280.0055	5280	0.00550	-1.0414
		T (°C)	60	5280.0070	5280	0.00700	-1.3260
		T (°C)	70	5280.0073	5280	0.00731	-1.3848
Limits				Within 5250-5350MHz			
Result				Complies			

Voltage vs. Frequency Stability

TEST CONDITIONS				Reference Frequency: 5320MHz			
				f	fc	Max. Deviation (MHz)	Max. Deviation (ppm)
T nom (°C)	20	V nom (V)	3.8	5320.0004	5320	0.00041	-0.0772
		V max (V)	4.2	5320.0037	5320	0.00373	-0.7004
		V min (V)	3.4	5320.0087	5320	0.00871	-1.6379
Limits				Within 5250-5350MHz			
Result				Complies			

Temperature vs. Frequency Stability

TEST CONDITIONS				Reference Frequency: 5320MHz			
				f	fc	Max. Deviation (MHz)	Max. Deviation (ppm)
V nom (V)	3.8	T (°C)	-20	5320.0015	5320	0.00146	-0.2745
		T (°C)	-10	5320.0043	5320	0.00434	-0.8153
		T (°C)	0	5320.0034	5320	0.00336	-0.6316
		T (°C)	10	5320.0033	5320	0.00327	-0.6141
		T (°C)	20	5320.0006	5320	0.00063	-0.1176
		T (°C)	30	5320.0009	5320	0.00088	-0.1657
		T (°C)	40	5320.0067	5320	0.00674	-1.2660
		T (°C)	50	5320.0079	5320	0.00786	-1.4775
		T (°C)	60	5320.0069	5320	0.00690	-1.2964
		T (°C)	70	5320.0057	5320	0.00575	-1.0808
Limits				Within 5250-5350MHz			
Result				Complies			

EUT :	E-book reader	Model Name. :	M6
Temperature :	25 °C	Relative Humidity :	56%
Pressure :	1012 hPa	Test Voltage :	DC 3.8V
Test Mode :	TX Frequency Band 2C (5470-5725MHz)		

Voltage vs. Frequency Stability

TEST CONDITIONS				Reference Frequency: 5500MHz			
				f	fc	Max. Deviation (MHz)	Max. Deviation (ppm)
T nom (°C)	20	V nom (V)	3.8	5500.0050	5500	0.00504	-0.9157
		V max (V)	4.2	5500.0042	5500	0.00418	-0.7592
		V min (V)	3.4	5500.0021	5500	0.00206	-0.3748
Limits				Within 5470-5725MHz			
Result				Complies			

Temperature vs. Frequency Stability

TEST CONDITIONS				Reference Frequency: 5500MHz			
				f	fc	Max. Deviation (MHz)	Max. Deviation (ppm)
V nom (V)	3.8	T (°C)	-20	5500.0000	5500	0.00004	-0.0073
		T (°C)	-10	5500.0062	5500	0.00616	-1.1191
		T (°C)	0	5500.0055	5500	0.00546	-0.9929
		T (°C)	10	5500.0081	5500	0.00815	-1.4810
		T (°C)	20	5500.0060	5500	0.00600	-1.0916
		T (°C)	30	5500.0003	5500	0.00033	-0.0593
		T (°C)	40	5500.0008	5500	0.00078	-0.1416
		T (°C)	50	5500.0091	5500	0.00913	-1.6597
		T (°C)	60	5500.0038	5500	0.00381	-0.6932
		T (°C)	70	5500.0050	5500	0.00499	-0.9064
Limits				Within 5470-5725MHz			
Result				Complies			

Voltage vs. Frequency Stability

TEST CONDITIONS				Reference Frequency: 5600MHz			
				f	fc	Max. Deviation (MHz)	Max. Deviation (ppm)
T nom (°C)	20	V nom (V)	3.8	5600.0052	5600	0.00523	-0.9340
		V max (V)	4.2	5600.0064	5600	0.00640	-1.1435
		V min (V)	3.4	5600.0081	5600	0.00806	-1.4390
Limits				Within 5470-5725MHz			
Result				Complies			

Temperature vs. Frequency Stability

TEST CONDITIONS				Reference Frequency: 5600MHz			
				f	fc	Max. Deviation (MHz)	Max. Deviation (ppm)
V nom (V)	3.8	T (°C)	-20	5600.0040	5600	0.00403	-0.7196
		T (°C)	-10	5600.0018	5600	0.00177	-0.3152
		T (°C)	0	5600.0038	5600	0.00384	-0.6854
		T (°C)	10	5600.0084	5600	0.00841	-1.5015
		T (°C)	20	5600.0022	5600	0.00216	-0.3863
		T (°C)	30	5600.0050	5600	0.00500	-0.8935
		T (°C)	40	5600.0080	5600	0.00799	-1.4264
		T (°C)	50	5600.0024	5600	0.00236	-0.4211
		T (°C)	60	5600.0038	5600	0.00379	-0.6765
		T (°C)	70	5600.0091	5600	0.00911	-1.6273
Limits				Within 5470-5725MHz			
Result				Complies			

Voltage vs. Frequency Stability

TEST CONDITIONS				Reference Frequency: 5700MHz			
				f	fc	Max. Deviation (MHz)	Max. Deviation (ppm)
T nom (°C)	20	V nom (V)	3.8	5700.0039	5700	0.00387	-0.6789
		V max (V)	4.2	5700.0098	5700	0.00976	-1.7117
		V min (V)	3.4	5700.0086	5700	0.00860	-1.5085
Limits				Within 5470-5725MHz			
Result				Complies			

Temperature vs. Frequency Stability

TEST CONDITIONS				Reference Frequency: 5700MHz			
				f	fc	Max. Deviation (MHz)	Max. Deviation (ppm)
V nom (V)	3.8	T (°C)	-20	5700.0029	5700	0.00287	-0.5032
		T (°C)	-10	5700.0017	5700	0.00167	-0.2931
		T (°C)	0	5700.0055	5700	0.00546	-0.9587
		T (°C)	10	5700.0084	5700	0.00842	-1.4780
		T (°C)	20	5700.0088	5700	0.00881	-1.5464
		T (°C)	30	5700.0075	5700	0.00754	-1.3223
		T (°C)	40	5700.0041	5700	0.00413	-0.7242
		T (°C)	50	5700.0086	5700	0.00860	-1.5089
		T (°C)	60	5700.0048	5700	0.00476	-0.8349
		T (°C)	70	5700.0012	5700	0.00122	-0.2135
Limits				Within 5470-5725MHz			
Result				Complies			

EUT :	E-book reader	Model Name. :	M6
Temperature :	25 °C	Relative Humidity :	56%
Pressure :	1012 hPa	Test Voltage :	DC 3.8V
Test Mode :	TX Frequency(5745-5850MHz)		

Voltage vs. Frequency Stability

TEST CONDITIONS				Reference Frequency: 5745MHz			
				f	fc	Max. Deviation (MHz)	Max. Deviation (ppm)
T nom (°C)	20	V nom (V)	3.8	5745.0054	5745	0.00540	-0.9403
		V max (V)	4.2	5745.0025	5745	0.00248	-0.4324
		V min (V)	3.4	5745.0074	5745	0.00744	-1.2951
Limits				Within 5745-5850MHz			
Result				Complies			

Temperature vs. Frequency Stability

TEST CONDITIONS				Reference Frequency: 5745MHz			
				f	fc	Max. Deviation (MHz)	Max. Deviation (ppm)
V nom (V)	3.8	T (°C)	-20	5745.0082	5745	0.00820	-1.4268
		T (°C)	-10	5745.0045	5745	0.00454	-0.7895
		T (°C)	0	5745.0026	5745	0.00256	-0.4462
		T (°C)	10	5745.0094	5745	0.00940	-1.6358
		T (°C)	20	5745.0010	5745	0.00101	-0.1759
		T (°C)	30	5745.0061	5745	0.00608	-1.0584
		T (°C)	40	5745.0026	5745	0.00259	-0.4505
		T (°C)	50	5745.0092	5745	0.00918	-1.5978
		T (°C)	60	5745.0071	5745	0.00711	-1.2375
		T (°C)	70	5745.0070	5745	0.00699	-1.2162
Limits				Within 5745-5850MHz			
Result				Complies			

Voltage vs. Frequency Stability

TEST CONDITIONS				Reference Frequency: 5785MHz			
				f	fc	Max. Deviation (MHz)	Max. Deviation (ppm)
T nom (°C)	20	V nom (V)	3.8	5785.0034	5785	0.00336	-0.5808
		V max (V)	4.2	5785.0005	5785	0.00046	-0.0796
		V min (V)	3.4	5785.0084	5785	0.00837	-1.4465
Limits				Within 5745-5850MHz			
Result				Complies			

Temperature vs. Frequency Stability

TEST CONDITIONS				Reference Frequency: 5785MHz			
				f	fc	Max. Deviation (MHz)	Max. Deviation (ppm)
V nom (V)	3.8	T (°C)	-20	5785.0008	5785	0.00078	-0.1345
		T (°C)	-10	5785.0088	5785	0.00878	-1.5175
		T (°C)	0	5785.0085	5785	0.00848	-1.4663
		T (°C)	10	5785.0051	5785	0.00515	-0.8902
		T (°C)	20	5785.0008	5785	0.00083	-0.1433
		T (°C)	30	5785.0055	5785	0.00550	-0.9505
		T (°C)	40	5785.0052	5785	0.00521	-0.9000
		T (°C)	50	5785.0025	5785	0.00246	-0.4253
		T (°C)	60	5785.0013	5785	0.00130	-0.2246
		T (°C)	70	5785.0021	5785	0.00212	-0.3666
Limits				Within 5745-5850MHz			
Result				Complies			

Voltage vs. Frequency Stability

TEST CONDITIONS				Reference Frequency: 5825MHz			
				f	fc	Max. Deviation (MHz)	Max. Deviation (ppm)
T nom (°C)	20	V nom (V)	3.8	5825.0013	5825	0.00133	-0.2286
		V max (V)	4.2	5825.0014	5825	0.00141	-0.2420
		V min (V)	3.4	5825.0012	5825	0.00116	-0.1991
Limits				Within 5745-5850MHz			
Result				Complies			

Temperature vs. Frequency Stability

TEST CONDITIONS				Reference Frequency: 5825MHz			
				f	fc	Max. Deviation (MHz)	Max. Deviation (ppm)
V nom (V)	3.8	T (°C)	-20	5825.0057	5825	0.00567	-0.9725
		T (°C)	-10	5825.0083	5825	0.00833	-1.4308
		T (°C)	0	5825.0079	5825	0.00789	-1.3550
		T (°C)	10	5825.0029	5825	0.00293	-0.5035
		T (°C)	20	5825.0058	5825	0.00577	-0.9910
		T (°C)	30	5825.0046	5825	0.00464	-0.7972
		T (°C)	40	5825.0041	5825	0.00411	-0.7060
		T (°C)	50	5825.0093	5825	0.00932	-1.6007
		T (°C)	60	5825.0059	5825	0.00591	-1.0141
T (°C)	70	5825.0066	5825	0.00663	-1.1390		
Limits				Within 5745-5850MHz			
Result				Complies			

9. DYNAMIC FREQUENCY SELECTION(DFS)

9.1 APPLICABILITY OF DFS REQUIREMENTS

EUT is client and operates as client without radar detection function.

Table 1: Applicability of DFS Requirements Prior to Use of a Channel

Requirement	Operational Mode		
	Master	Client Without Radar Detection	Client With Radar Detection
Non-Occupancy Period	Yes	Not required	Yes
DFS Detection Threshold	Yes	Not required	Yes
Channel Availability Check Time	Yes	Not required	Not required
U-NII Detection Bandwidth	Yes	Not required	Yes

Table 2: Applicability of DFS requirements during normal operation

Requirement	Operational Mode		
	Master	Client Without Radar Detection	Client With Radar Detection
DFS Detection Threshold	Yes	Not required	Yes
Channel Closing Transmission Time	Yes	Yes	Yes
Channel Move Time	Yes	Yes	Yes
U-NII Detection Bandwidth	Yes	Not required	Yes
Client Beacon Test	N/A	Yes	Yes

Additional requirements for devices with multiple bandwidth modes	Operational Mode	
	Master or Client With Radar Detection	Client Without Radar Detection
U-NII Detection Bandwidth and Statistical Performance Check	All BW modes must be tested	Not required
Channel Move Time and Channel Closing Transmission Time	Test using widest BW mode available	Test using the widest BW mode available for the link
All other tests	Any single BW mode	Not required
<p>Note Frequencies selected for statistical performance check (Section 7.8.4) should include several frequencies within the radar detection bandwidth and frequencies near the edge of the radar detection bandwidth. For 802.11 devices it is suggested to select frequencies in each of the bonded 20 MHz channels and the channel center frequency.</p>		

9.2 INTERFERENCE THRESHOLD VALUES, MASTER OR CLIENT INCORPORATING IN-SERVICE MONITORING

Maximum Transmit Power	Value (see notes 1, 2, and 3)
EIRP ≥ 200 milliwatt	-64 dBm
EIRP < 200 milliwatt and power spectral density < 10 dBm/MHz	-62 dBm
EIRP < 200 milliwatt that do not meet the power spectral density requirement	-64 dBm
<p>Note 1: This is the level at the input of the receiver assuming a 0 dBi receive antenna.</p> <p>Note 2: Throughout these test procedures an additional 1 dB has been added to the amplitude of the test transmission waveforms to account for variations in measurement equipment. This will ensure that the test signal is at or above the detection threshold level to trigger a DFS response.</p> <p>Note 3: EIRP is based on the highest antenna gain.</p>	

9.3 DFS RESPONSE REQUIREMENT VALUES

Parameter	Value
Non-occupancy period	Minimum 30 minutes
Channel Availability Check Time	60 seconds
Channel Move Time	10 seconds See Note 1.
Channel Closing Transmission Time	200 milliseconds + an aggregate of 60 milliseconds over remaining 10 second period. See Notes 1 and 2.
U-NII Detection Bandwidth	Minimum 100% of the 99% power bandwidth See Note 3.

Note 1: The instant that the Channel Move Time and the Channel Closing Transmission Time begins is as follows:

- For the Short pulse radar Test Signals this instant is the end of the Burst.
- For the Frequency Hopping radar Test Signal, this instant is the end of the last radar Burst generated.
- For the Long Pulse radar Test Signal this instant is the end of the 12 second period defining the radar transmission.

Note 2: The Channel Closing Transmission Time is comprised of 200 milliseconds starting at the beginning of the Channel Move Time plus any additional intermittent control signals required to facilitate Channel changes (an aggregate of 60 milliseconds) during the remainder of the 10 second period. The aggregate duration of control signals will not count quiet periods in between transmissions.

Note 3: During the U-NII Detection Bandwidth detection test, radar type 0 is used and for each frequency step the minimum percentage of detection is 90%. Measurements are performed with no data traffic.

9.4 SHORT PULSE RADAR TEST WAVEFORMS

As the EUT is a Client Device with no Radar Detection, only one type radar pulse is required for the testing. Radar Pulse type 0 was used in the evaluation of the Client device for the purpose of measuring the Channel Move Time and the Channel Closing Transmission Time.

Radar Type	Pulse Width (µsec)	PRI (µsec)	Number of Pulses	Minimum Percentage of Successful Detection	Minimum Trials
0	1	1428	18	60%	30
1	1	Test A Test B	$\text{Roundup}\left(\frac{1}{360} \cdot \frac{19 \cdot 10^6}{\text{PRI}_{\text{min}}}\right)$	60%	30
2	1-5	150-230	23-29	60%	30
3	6-10	200-500	16-18	60%	30
4	11-20	200-500	12-16	60%	30
Aggregate (Radar Types 1-4)				80%	120

Test A: 15 unique PRI values randomly selected from the list of 23 PRI values in Table 5a
 Test B: 15 unique PRI values randomly selected within the range of 518-3066 µsec, with a minimum increment of 1 µsec, excluding PRI values selected in Test A

A minimum of 30 unique waveforms are required for each of the short pulse radar types 2 through 4. For short pulse radar type 1, the same waveform is used a minimum of 30 times. If more than 30 waveforms are used for short pulse radar types 2 through 4, then each additional waveform must also be unique and not repeated from the previous waveforms.
 If more than 30 waveforms are used for Short Pulse Radar Type 1, then each additional waveform is generated with Test B and must also be unique and not repeated from the previous waveforms in Tests A or B. The aggregate is the average of the percentage of successful detections of short pulse radar types 1-4.

9.5 CALIBRATION SETUP AND DFS TEST RESULTS

Radar Waveform Calibration Procedure

- 1) A 50 ohm load is connected in place of the spectrum analyzer, and the spectrum analyzer is connected to place of the master
- 2) The interference Radar Detection Threshold Level is $-62\text{dBm} - 2\text{dBi} + 1\text{dB} = -63\text{dBm}$ that had been taken into account the output power range and antenna gain.
- 3) The following equipment setup was used to calibrate the conducted radar waveform. A vector signal generator was utilized to establish the test signal level for radar type 0. During this process there were no transmissions by either the master or client device. The spectrum analyzer was switched to the zero spans (time domain) at the frequency of the radar waveform generator. Peak detection was used. The spectrum analyzer resolution bandwidth (RBW) and video bandwidth (VBW) were set to 3 MHz. The spectrum analyzer had offset -1.0dB to compensate RF cable loss 1.0dB .
- 4) The vector signal generator amplitude was set so that the power level measured at the spectrum analyzer was $-62\text{dBm} - 2\text{dBi} + 1\text{dB} = -63\text{dBm}$. Capture the spectrum analyzer plots on short pulse radar waveform.

9.6 CONDUCTED CALIBRATION SETUP

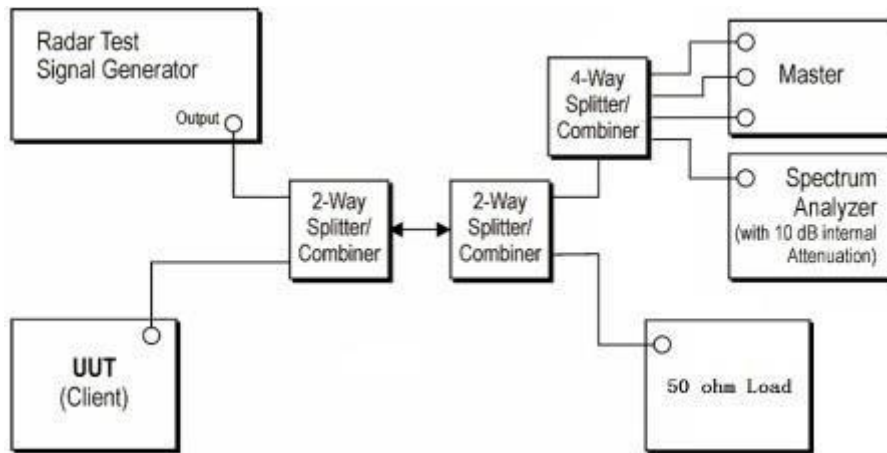

Wireless AP	Manufacturer	ASUSTek Computer Inc
	Model NO.	AX5400
	FCC ID	MSQ-RTAXJ300

- Note: 1. The Slave device associated with the EUT during these tests does not have radar detection capability.
2. WLAN traffic is generated by using the iperf software to send packets from the Master IP address to the Slave IP address.
 3. The time required for the master and slave devices to fully start up is 120s.
 4. EUT does not support TPC.

9.7 RADAR WAVEFORM CALIBRATION RESULT

Test data reference attachment.

9.8 IN-SERVICE MONITORING: CHANNEL MOVE TIME, CHANNEL CLOSING TRANSMISSION TIME AND NON-OCCUPANCY PERIOD

TEST CONFIGURATION:

Setup for Client with injection at the Master

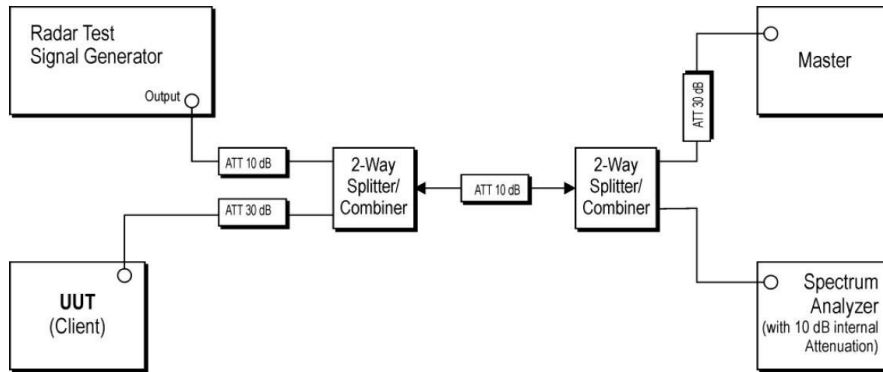

TEST PROCEDURE:

1. The radar pulse generator is setup to provide a pulse at frequency that the master and client are operating. A type 0 radar pulse with a 1us pulse width and a 1428us PRI is used for the testing.
2. The vector signal generator is adjusted to provide the radar burst (18 pulses) at the level of approximately -61dBm at the antenna port of the master device
3. A trigger is provided from the pulse generator to the DFS monitoring system in order to capture the traffic and the occurrence of the radar pulse.
4. EUT will associate with the master at channel. The file "iperf.exe" specified by the FCC is Streamed from the PC 2 through the master and the client device to the PC 1 and played in full motion video using Media Player Classic Ver. 6.4.8.6 in order to properly load the network for the entire period of the test.
5. When radar burst with a level equal to the DFS Detection Threshold +1dB is generated on the operating channel of the U-NII device. At time T0 the radar waveform generator sends a burst of pulse of the radar waveform at Detection Threshold +1dB.
6. Observe the transmissions of the EUT at the end of the radar Burst on the Operating Channel Measure and record the transmissions from the UUT during the observation time (Channel Move Time). One 15 seconds plot is reported for the Short Pulse Radar Type 0. The plot for the Short Pulse Radar Types start at the end of the radar burst. The Channel Move Time will be calculated based on the zoom In 600ms plot of the Short Pulse Radar Type
7. Measurement of the aggregate duration of the Channel Closed Transmission Time method. With the spectrum analyzer set to zero span tuned to the center frequency of the EUT operating channel at the radar simulated frequency, peak detection, and max hold, the dwell time per bin is given by: $Dwell (0.3ms) = S (12000ms) / B (4000)$; where Dwell is the dwell time per spectrum analyzer sampling bin, S is sweep time and B is the number of spectrum analyzer sampling bins. An upper bound of the aggregate duration of the intermittent control signals of Channel Closing Transmission Time is calculated by: $C (ms) = N \times Dwell (0.3ms)$; where C is the Closing Time, N is the number of spectrum analyzer sampling bins (intermittent control signals) showing a U-NII transmission and Dwell is the dwell time per bin.
8. Measurement the EUT for more than 30 minutes following the channel move time to verify that no transmission or beacons occur on this channel.

TEST MODE:

Please refer to the clause 2.2

**9.9 RESULT OF CHANNEL MOVE TIME, CHANNEL CLOSING TRANSMISSION TIME AND
NON-OCCUPANCY PERIOD FOR CLIENT BEACON TEST**

TEST DATA REFERENCE ATTACHMENT.

9. ANTENNA REQUIREMENT

9.1 STANDARD REQUIREMENT

15.203 requirement: For intentional device, according to 15.203: an intentional radiator shall be designed to ensure that no antenna other than that furnished by the responsible party shall be used with the device.

9.2 EUT ANTENNA

The EUT antenna is permanent attached FPCB antenna (antenna gain: -0.07 dBi). It comply with the standard requirement.

END OF REPORT