

Product specification

Quick Reference Date

	Antenna module on the system board
Frequenc Range	2400 ~ 2500MHz
Ant. Port Input Pwr. (dBm)	0 (Typ. BT class 2 output power)
Tot. Rad. Pwr.(dBm)	-1.2 (Input pwr – loss pwr)
Peak EIRP (dBm)	1.2
Directivity (dBi)	1 (all direction antenna)
Efficiency (dB)	6 0.2 %
Gain (dBi)	1.9 (Avg Gain XY-plane)
Maximum Power (dBm)	1.7 (XY-plane)
Minimum Power (dBm)	-4(XY-plane)
Avg. Power (dBm)	-0.5(XY-plane)
Input Impedence(ohm)	50
Polarization Type	V ertical & Horizontal
V . S .W . R	< 1.4
Manufacture	SHANGJAIN MOUNTAIN VIEW SILICON TECHNOLOGV CO LTD
Address	4c, Building 3, Hengyue International Building, Lane 1238, Zhangjiang Road, Pudong New Area, Shanghai

All the technical data and information contained herein are subject to change without prior notice

Antenna Layout & module on the system board

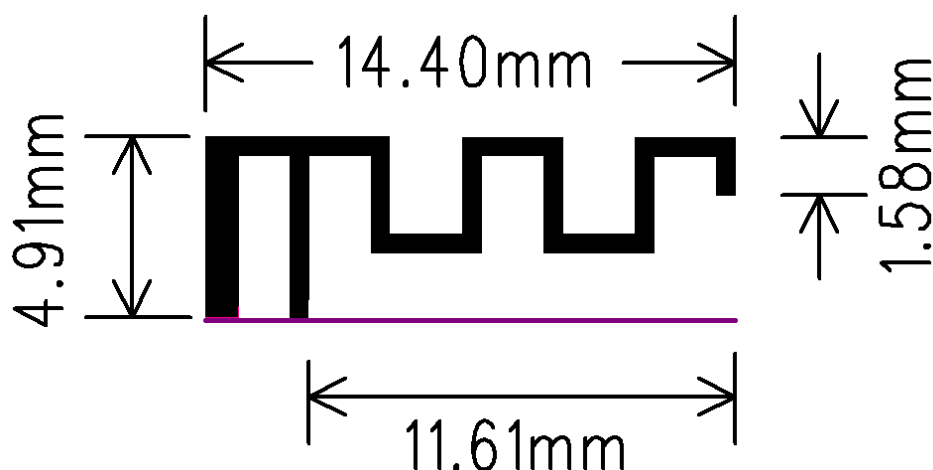

Antenna Gain

Gain Table

Unit in dBi @244GHz	XY-plane		XZ-plane		YZ-plane		Efficiency
	Peak	Avg.	Peak	Avg.	Peak	Avg.	
Module Board	1.2	-0.5	1.9	-3.6	1.1	-3.0	6 0.2 %

Antenna type: Flat strip antenna

Antenna no.: L-D

Return Loss

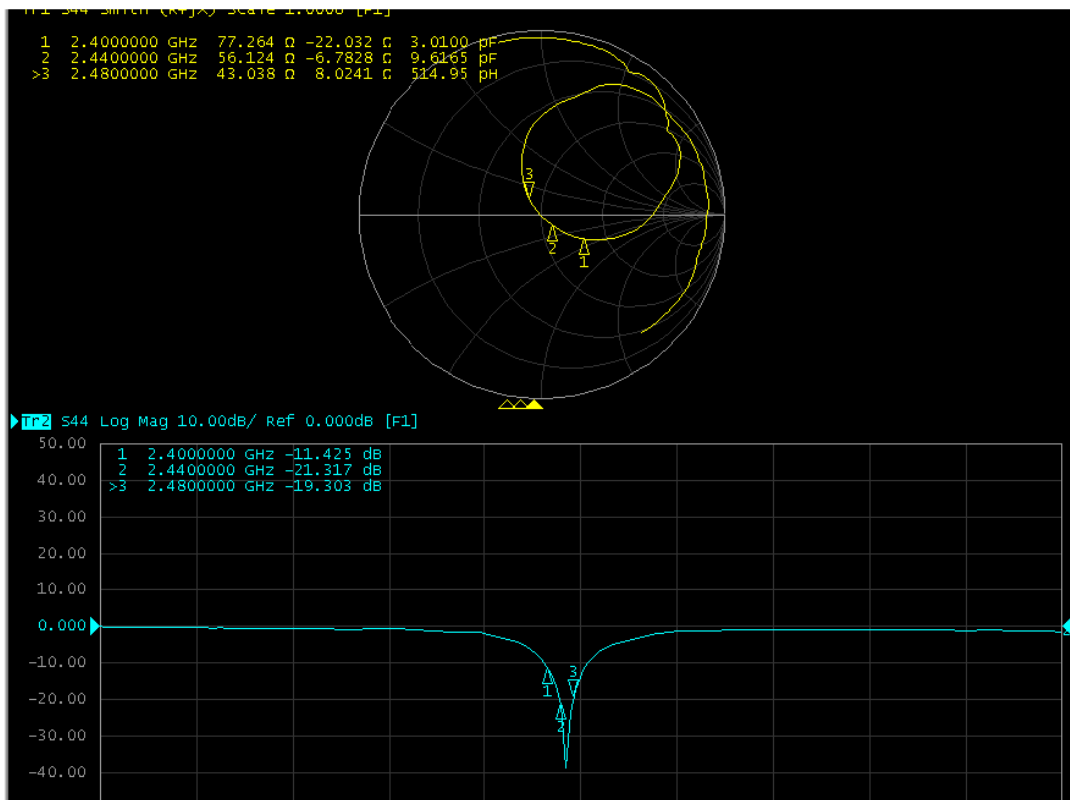

The Environment of Antenna Radiation Pattern

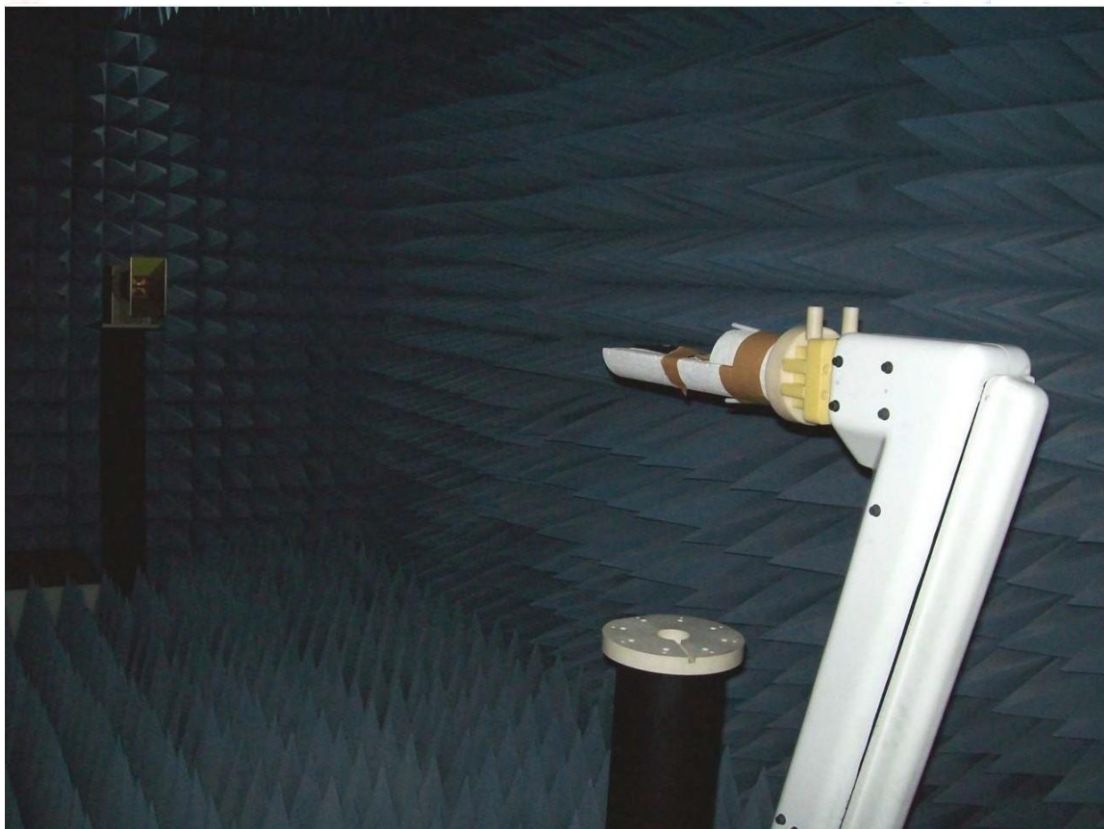
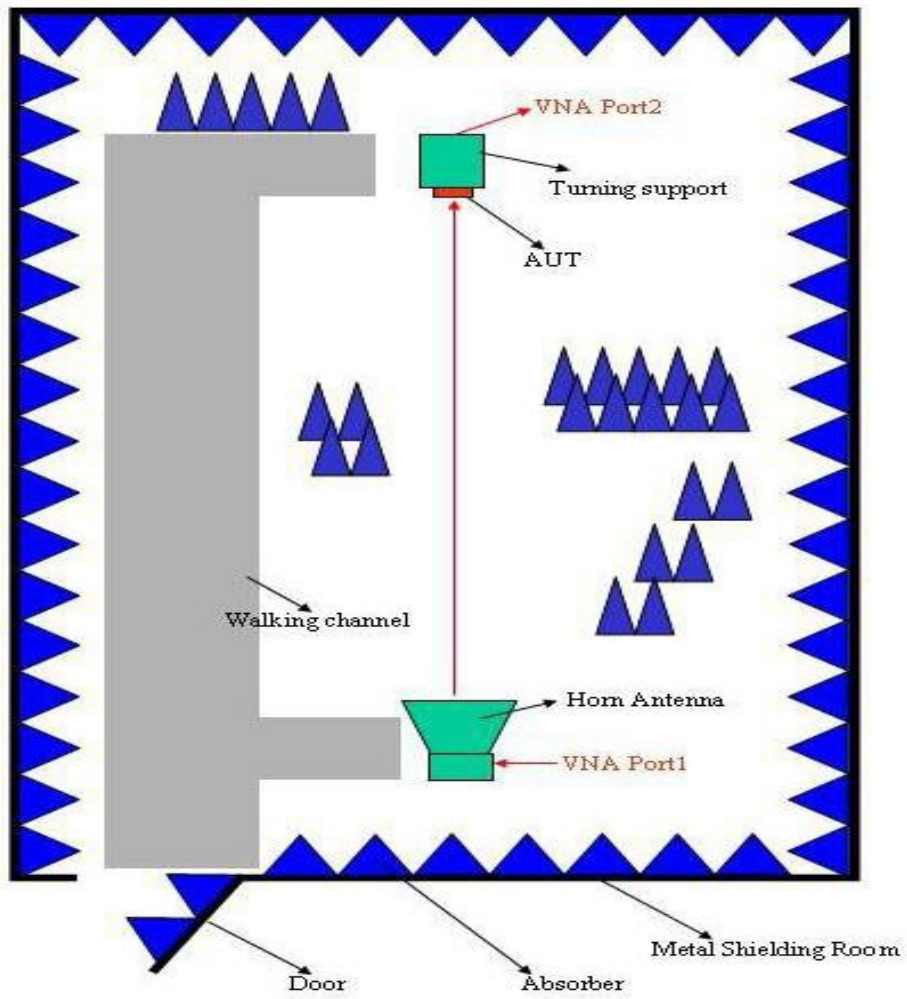

3D radiation pattern diagram

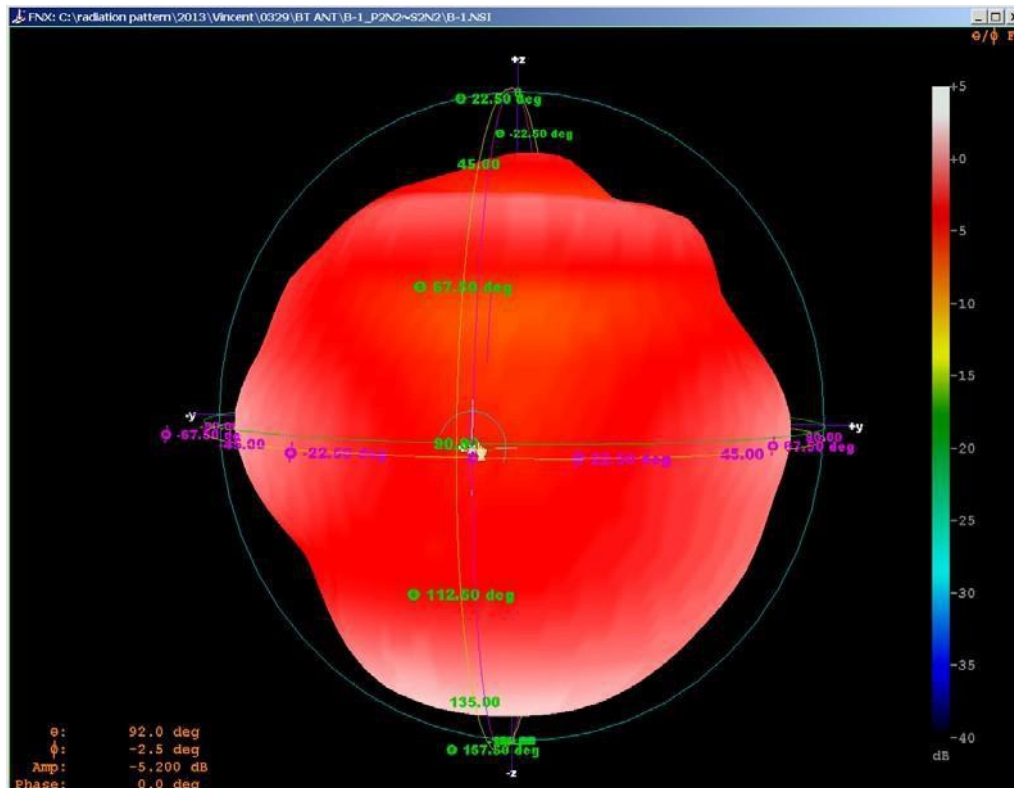

XY-plane

Far-field Power Distribution(H+V) on X-Y Plane
Plot Peak Gain(H+V)= 1.35 dB; Plot AvgGain(H+V)= -0.48dB @2.44000 GHz

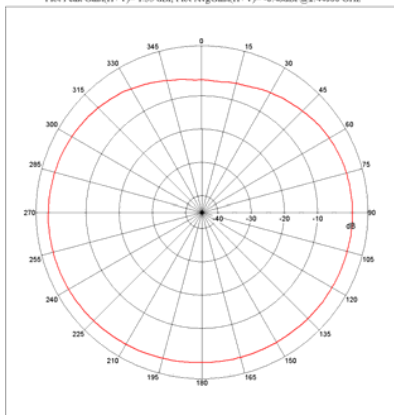

XZ-plane

Far-field Power Distribution(H+V) on X-Z Plane
Plot Peak Gain(H+V)= 1.68 dB; Plot AvgGain(H+V)= -3.83dB @2.44000 GHz

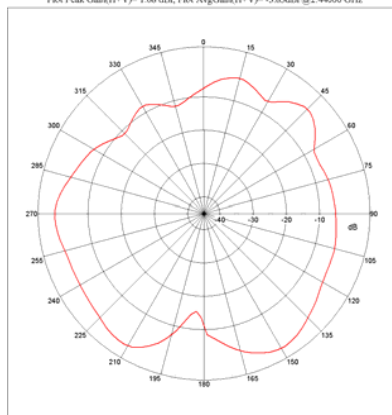

YZ-plane

Far-field Power Distribution(H+V) on Y-Z Plane
Plot Peak Gain(H+V)= 1.11 dB; Plot AvgGain(H+V)= -2.99dB @2.44000 GHz

