



FCC TEST REPORT

**Test report
On Behalf of
Southern Audio Services, Inc
For**

Wireless relay pack

**Model No.: YP-RP5WR, YP-RP5W-OR, YP-RP5W-OEM,
YP-RP5W-OEM2, YP-RP5W-OEM3, YP-RP5W-ASC, YP-RP5W-01,
YP-RP5W-02, YP-RP5W-03**

FCC ID: 2A4ZE-YP-RP5WR

**Prepared for : Southern Audio Services, Inc
14763 Florida Blvd, Baton Rouge, LA 70819**

**Prepared By : Shenzhen HUAK Testing Technology Co., Ltd.
1-2/F., Building B2, Junfeng Zhongcheng Zhizao Innovation Park, Heping,
Fuhai Street, Bao'an District, Shenzhen, Guangdong, China**

Date of Test: Feb. 08, 2022 ~ Feb. 28, 2022

Date of Report: Feb. 28, 2022

Report Number: HK2202220586-E



TEST RESULT CERTIFICATION

Applicant's name : Southern Audio Services, Inc
Address : 14763 Florida Blvd, Baton Rouge, LA 70819
Manufacturer's Name : Southern Audio Services, Inc
Address : 14763 Florida Blvd, Baton Rouge, LA 70819

Product description

Trade Mark: N/A
Product name : Wireless relay pack
Model and/or type reference : YP-RP5WR, YP-RP5W-OR, YP-RP5W-OEM, YP-RP5W-OEM2, YP-RP5W-OEM3, YP-RP5W-ASC, YP-RP5W-01, YP-RP5W-02, YP-RP5W-03

Standards : FCC Rules and Regulations Part 15 Subpart C Section 15.249
ANSI C63.10: 2013

This publication may be reproduced in whole or in part for non-commercial purposes as long as the Shenzhen HUAK Testing Technology Co., Ltd. is acknowledged as copyright owner and source of the material. Shenzhen HUAK Testing Technology Co., Ltd. takes no responsibility for and will not assume liability for damages resulting from the reader's interpretation of the reproduced material due to its placement and context.

Date of Test :
Date (s) of performance of tests : Feb. 08, 2022 ~ Feb. 28, 2022
Date of Issue : Feb. 28, 2022
Test Result : Pass

Testing Engineer : Gary Qian
(Gary Qian)

Technical Manager : Eden Hu
(Eden Hu)

Authorized Signatory : Jason Zhou
(Jason Zhou)

The results shown in this test report refer only to the sample(s) tested unless otherwise stated and the sample(s) are retained for 30 days only. The document is issued by HUAK, this document cannot be reproduced except in full with our prior written permission. The more details and the authenticity of the report will be confirmed at http://www.cer-mark.com.



| Table of Contents | Page |
|---|-------------|
| 1 . TEST SUMMARY | 5 |
| 2 . GENERAL INFORMATION | 6 |
| 2.1 GENERAL DESCRIPTION OF EUT | 6 |
| 2.2 Carrier Frequency of Channels | 7 |
| 2.3 Operation of EUT during testing | 7 |
| 2.4 DESCRIPTION OF TEST SETUP | 7 |
| 2.5 MEASUREMENT INSTRUMENTS LIST | 8 |
| 3 . CONDUCTED EMISSIONS TEST | 9 |
| 3.1 Conducted Power Line Emission Limit | 9 |
| 3.2 Test Setup | 9 |
| 3.3 Test Procedure | 9 |
| 3.4 Test Result | 10 |
| 4 RADIATED EMISSION TEST | 11 |
| 4.1 Radiation Limit | 11 |
| 4.2 Test Setup | 11 |
| 4.3 Test Procedure | 12 |
| 4.4 Test Result | 12 |
| 5 BAND EDGE | 16 |
| 5.1 Limits | 16 |
| 5.2 Test Procedure | 16 |
| 5.3 Test Result | 17 |
| 6 OCCUPIED BANDWIDTH MEASUREMENT | 18 |
| 6.1 Test Setup | 18 |
| 6.2 Test Procedure | 18 |
| 6.3 Measurement Equipment Used | 18 |
| 6.4 Test Result | 18 |
| 7 ANTENNA REQUIREMENT | 19 |
| 8 PHOTOGRAPH OF TEST | 20 |
| 8.1 Radiated Emission | 20 |
| 9 PHOTOS OF THE EUT | 21 |



**** Modified History ****

| Revision | Description | Issued Data | Remark |
|-----------------|-----------------------------|--------------------|---------------|
| Revision 1.0 | Initial Test Report Release | Feb. 27, 2022 | Jason Zhou |
| | | | |
| | | | |

The results shown in this test report refer only to the sample(s) tested unless otherwise stated and the sample(s) are retained for 30 days only. The document is issued by HUAK, this document cannot be reproduced except in full with our prior written permission. The more details and the authenticity of the report will be confirmed at <http://www.cer-mark.com>.

HUAK Testing Lab TEL : +86-755 2302 9901 FAX : +86-755 2302 9901 E-mail : service@cer-mark.com

1-2/F., Building B2, Junfeng Zhongcheng Zhizao Innovation Park, Heping, Fuhai Street, Bao'an District, Shenzhen, Guangdong, China



1. TEST SUMMARY

1.1 TEST PROCEDURES AND RESULTS

| DESCRIPTION OF TEST | | RESULT |
|--------------------------------|------------------------|-----------|
| CONDUCTED EMISSIONS TEST | § 15.207 | N/A |
| RADIATED EMISSION TEST | § 15.249 (a) / §15.209 | COMPLIANT |
| BAND EDGE | § 15.249 (d) / §15.209 | COMPLIANT |
| OCCUPIED BANDWIDTH MEASUREMENT | § 15.215 (c) | COMPLIANT |
| ANTENNA REQUIREMENT | § 15.203 | COMPLIANT |

1.2 INFORMATION OF THE TEST LABORATORY

Shenzhen HUAK Testing Technology Co., Ltd.

Add.: 1-2/F., Building B2, Junfeng Zhongcheng Zhizao Innovation Park, Heping, Fuhai Street, Bao'an District, Shenzhen, Guangdong, China

Testing Laboratory Authorization :

A2LA Accreditation Code is 4781.01.

FCC Designation Number is CN1229.

Canada IC CAB identifier is CN0045.

CNAS Registration Number is L9589.

1.3 MEASUREMENT UNCERTAINTY

Measurement Uncertainty

Conducted Emission Expanded Uncertainty = 2.23dB, k=2

Radiated emission expanded uncertainty(9kHz-30MHz) = 3.08dB, k=2

Radiated emission expanded uncertainty(30MHz-1000MHz) = 4.42dB, k=2

Radiated emission expanded uncertainty(Above 1GHz) = 4.06dB, k=2



2. GENERAL INFORMATION

2.1 GENERAL DESCRIPTION OF EUT

| | |
|---------------------|--|
| Equipment | Wireless relay pack |
| Model Name | YP-RP5WR |
| Series Models | YP-RP5W-OR, YP-RP5W-OEM, YP-RP5W-OEM2, YP-RP5W-OEM3, YP-RP5W-ASC, YP-RP5W-01, YP-RP5W-02, YP-RP5W-03 |
| Model Difference | All model's the function, software and electric circuit are the same, only with a product color, appearance and model named different. Test sample model: YP-RP5WR |
| FCC ID | 2A4ZEYP-RP5WR |
| Antenna Type | PCB Antenna |
| Antenna Gain | 0dBi |
| Equipment | Wireless relay pack |
| Operation frequency | 2478MHz |
| Number of Channels | 1CH |
| Modulation Type | GFSK |
| Power Source | DC 12V |
| Power Rating | DC 12V |

The results shown in this test report refer only to the sample(s) tested unless otherwise stated and the sample(s) are retained for 30 days only. The document is issued by HUAK, this document cannot be reproduced except in full with our prior written permission. The more details and the authenticity of the report will be confirmed at <http://www.cer-mark.com>.



2.2 Carrier Frequency of Channels

| Channel List | |
|--------------|-----------------|
| Channel | Frequency (MHz) |
| 01 | 2478 |

2.3 Operation of EUT during testing

Operating Mode

The mode is used: **Transmitting mode**

Channel: 2478MHz

2.4 DESCRIPTION OF TEST SETUP

Operation of EUT during conducted testing and Radiation testing:

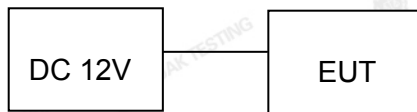

The sample was placed (0.8m below 1GHz, 1.5m above 1GHz) above the ground plane of 3m chamber. Measurements in both horizontal and vertical polarities were performed. During the test, each emission was maximized by: having the EUT continuously working, investigated all operating modes, rotated about all 3 axis (X, Y & Z) and considered typical configuration to obtain worst position, manipulating interconnecting cables, rotating the turntable, varying antenna height from 1m to 4m in both horizontal and vertical polarizations. The emissions worst-case are shown in Test Results of the following pages. The worst case is X position



2.5 MEASUREMENT INSTRUMENTS LIST

| Item | Equipment | Manufacturer | Model No. | Serial No. | Last Cal. | Cal. Interval |
|------|---|--------------------|---------------------|------------|---------------|---------------|
| 1. | L.I.S.N. Artificial Mains Network | R&S | ENV216 | HKE-002 | Dec. 09, 2021 | 1 Year |
| 2. | Receiver | R&S | ESR-7 | HKE-010 | Dec. 09, 2021 | 1 Year |
| 3. | RF automatic control unit | Tonscend | JS0806-2 | HKE-060 | Dec. 09, 2021 | 1 Year |
| 4. | Spectrum analyzer | R&S | FSP40 | HKE-025 | Dec. 09, 2021 | 1 Year |
| 5. | Spectrum analyzer | Agilent | N9020A | HKE-048 | Dec. 09, 2021 | 1 Year |
| 6. | Preamplifier | Schwarzbeck | BBV 9743 | HKE-006 | Dec. 09, 2021 | 1 Year |
| 7. | EMI Test Receiver | Rohde & Schwarz | ESCI 7 | HKE-010 | Dec. 09, 2021 | 1 Year |
| 8. | Bilog Broadband Antenna | Schwarzbeck | VULB9163 | HKE-012 | Dec. 09, 2021 | 1 Year |
| 9. | Loop Antenna | Schwarzbeck | FMZB 1519 B | HKE-014 | Dec. 09, 2021 | 1 Year |
| 10. | Horn Antenna | Schwarzbeck | 9120D | HKE-013 | Dec. 09, 2021 | 1 Year |
| 11. | Pre-amplifier | EMCI | EMC051845S E | HKE-015 | Dec. 09, 2021 | 1 Year |
| 12. | Pre-amplifier | Agilent | 83051A | HKE-016 | Dec. 09, 2021 | 1 Year |
| 13. | EMI Test Software EZ-EMC | Tonscend | JY3120-B Version | HKE-083 | Dec. 09, 2021 | N/A |
| 14. | Power Sensor | Agilent | E9300A | HKE-086 | Dec. 09, 2021 | 1 Year |
| 15. | Spectrum analyzer | Agilent | N9020A | HKE-048 | Dec. 09, 2021 | 1 Year |
| 16. | Signal generator | Agilent | N5182A | HKE-029 | Dec. 09, 2021 | 1 Year |
| 17. | Signal Generator | Agilent | 83630A | HKE-028 | Dec. 09, 2021 | 1 Year |
| 18. | Shielded room | Shiel Hong | 4*3*3 | HKE-039 | Dec. 17, 2020 | 3 Year |
| 19. | High gain antenna | Schwarzbeck | LB-180400KF | HKE-054 | Dec. 09, 2021 | 1 Year |

The results shown in this test report refer only to the sample(s) tested unless otherwise stated and the sample(s) are retained for 30 days only. The document is issued by HUAK, this document cannot be reproduced except in full with our prior written permission. The more details and the authenticity of the report will be confirmed at <http://www.cer-mark.com>.

HUAK Testing Lab TEL : +86-755 2302 9901 FAX : +86-755 2302 9901 E-mail : service@cer-mark.com

1-2/F., Building B2, Junfeng Zhongcheng Zhizao Innovation Park, Heping, Fuhai Street, Bao'an District, Shenzhen, Guangdong, China

3. CONDUCTED EMISSIONS TEST

3.1 Conducted Power Line Emission Limit

For unintentional device, according to § 15.107(a) Line Conducted Emission Limits is as following

| Frequency (MHz) | Maximum RF Line Voltage (dBµV) | | | |
|-----------------|--------------------------------|------|---------|--------|
| | CLASS A | | CLASS B | |
| | Q.P. | Ave. | Q.P. | Ave. |
| 0.15 - 0.50 | 79 | 66 | 66-56* | 56-46* |
| 0.50 - 5.00 | 73 | 60 | 56 | 46 |
| 5.00 - 30.0 | 73 | 60 | 60 | 50 |

* Decreasing linearly with the logarithm of the frequency

For intentional device, according to §15.207(a) Line Conducted Emission Limit is same as above table.

3.2 Test Setup

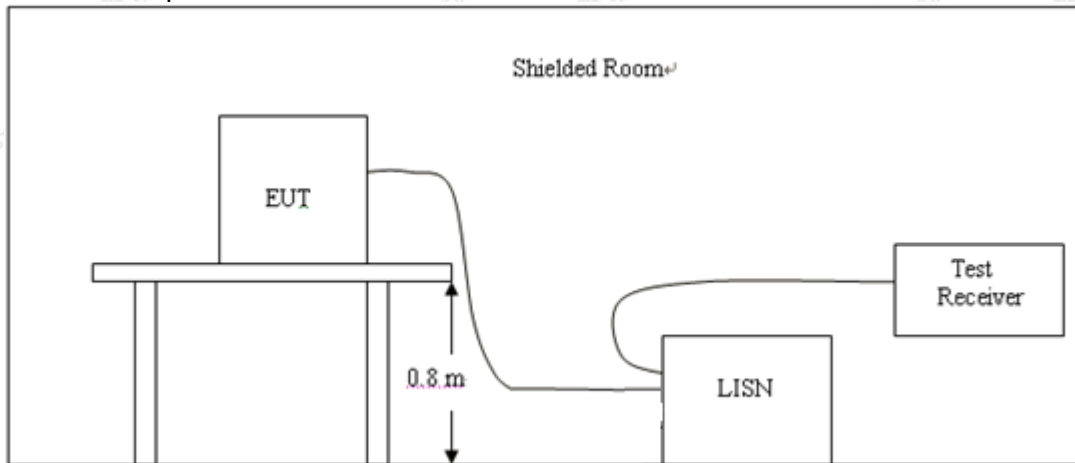

3.3 Test Procedure

- 1, The equipment was set up as per the test configuration to simulate typical actual usage per the user's manual. The EUT is a tabletop system, a wooden table with a height of 0.8 meters is used and is placed on the ground plane as per ANSI C63.10.
- 2, Support equipment, if needed, was placed as per ANSI C63.10.
- 3, All I/O cables were positioned to simulate typical actual usage as per ANSI C63.10.
- 4, If a EUT received DC power from the USB Port of Notebook PC, the PC's adapter received AC120V/60Hz power through a Line Impedance Stabilization Network (LISN) which supplied power source and was grounded to the ground plane.
- 5, All support equipments received AC power from a second LISN, if any.
- 6, The EUT test program was started. Emissions were measured on each current carrying line of the EUT using a spectrum Analyzer / Receiver connected to the LISN powering the EUT. The LISN has two monitoring points: Line 1 (Hot Side) and Line 2 (Neutral Side). Two scans were taken: one with Line 1 connected to Analyzer / Receiver and Line 2 connected to a 50 ohm load; the second scan had Line 1 connected to a 50 ohm load and Line 2 connected to the Analyzer / Receiver.
- 7, Analyzer / Receiver scanned from 150 KHz to 30MHz for emissions in each of the test modes.



3.4 Test Result

Not applicable

Note: EUT powers supply by DC Power, so this test item not applicable.

4 RADIATED EMISSION TEST

4.1 Radiation Limit

For unintentional device, according to § 15.109(a), except for Class A digital devices, the field strength of radiated emissions from unintentional radiators at a distance of 3 meters shall not exceed the following values:

| Frequency (MHz) | Distance (Meters) | Radiated (dB μ V/m) | Radiated (μ V/m) |
|-----------------|-------------------|-------------------------|-----------------------|
| 30-88 | 3 | 40 | 100 |
| 88-216 | 3 | 43.5 | 150 |
| 216-960 | 3 | 46 | 200 |
| Above 960 | 3 | 54 | 500 |

For intentional device, according to § 15.209(a), the general requirement of field strength of radiated emissions from intentional radiators at a distance of 3 meters shall not exceed the above table.

4.2 Test Setup

(1) Radiated Emission Test-Up Frequency Below 30MHz

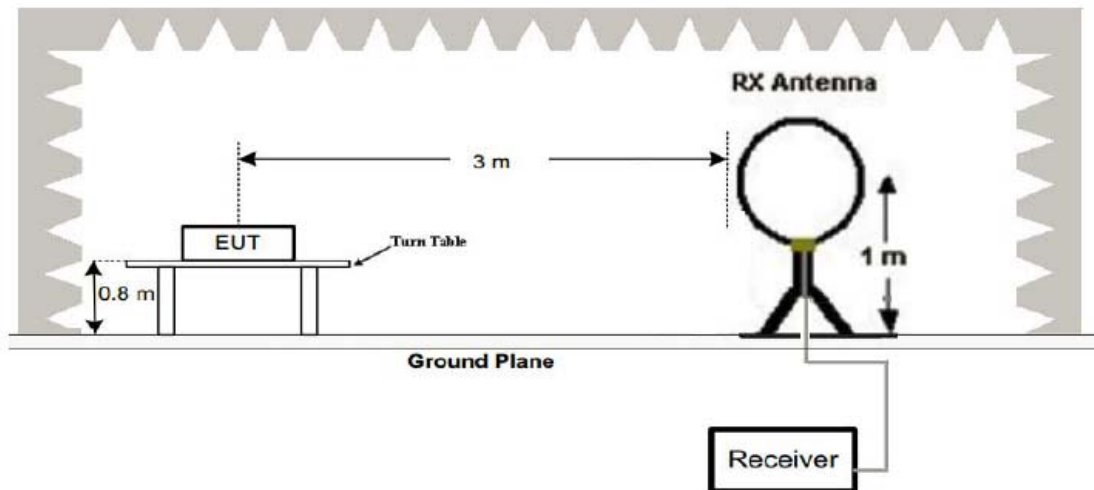

(2) Radiated Emission Test-Up Frequency 30MHz~1GHz

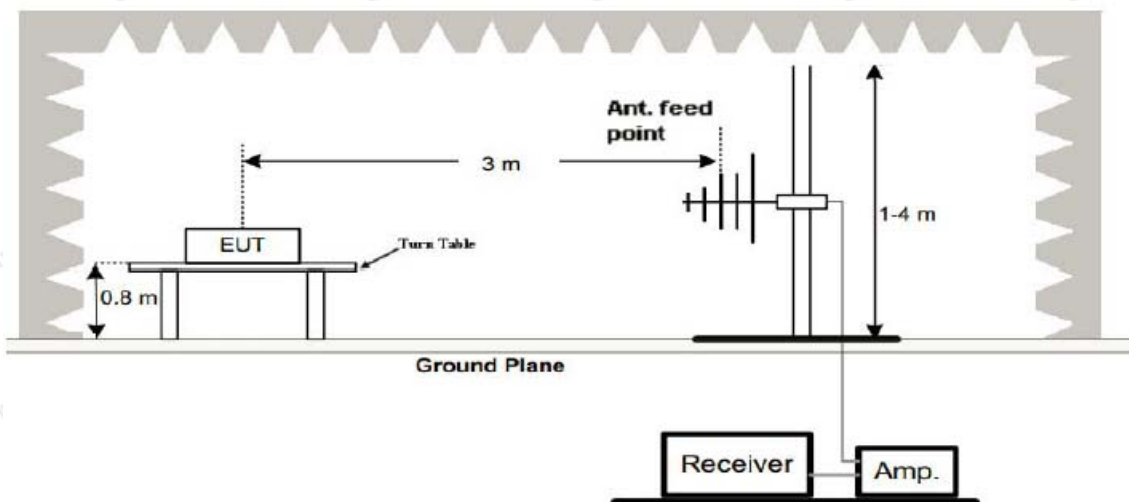



(3) Radiated Emission Test-Up Frequency Above 1GHz

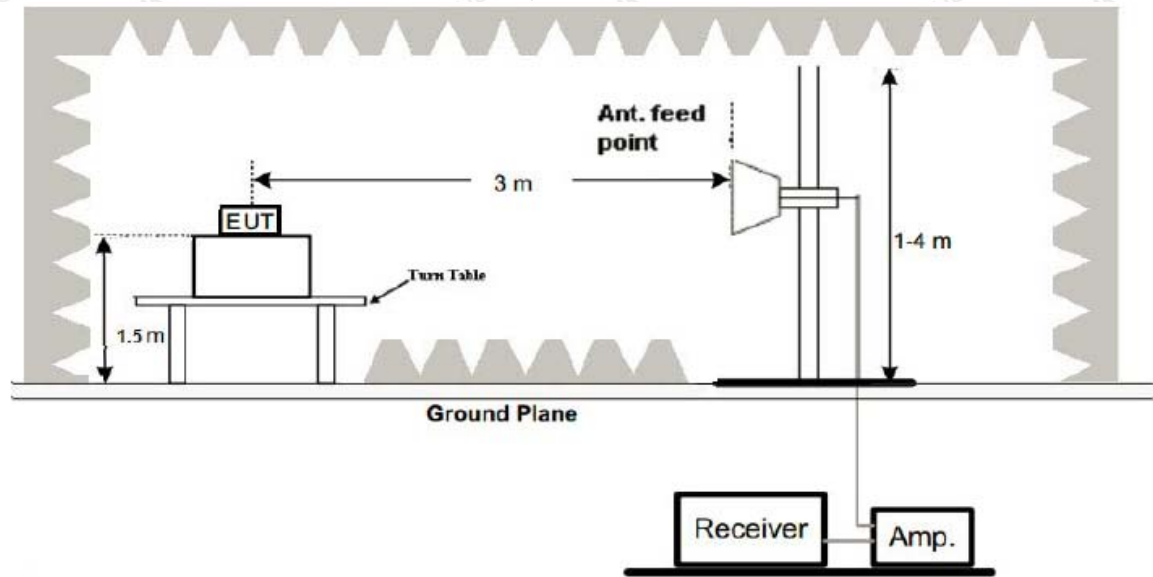

4.3 Test Procedure

1. Below 1GHz measurement the EUT is placed on turntable which is 0.8m above ground plane. And above 1GHz measurement EUT was placed on low permittivity and low tangent turn table which is 1.5m above ground plane.
2. The turntable shall be rotated for 360 degrees to determine the position of maximum emission level.
3. EUT is set 3m away from the receiving antenna, which is varied from 1m to 4m to find out the highest emissions.
4. Maximum procedure was performed on the six highest emissions to ensure EUT compliance.
5. And also, each emission was to be maximized by changing the polarization of receiving antenna both horizontal and vertical.
6. Repeat above procedures until the measurements for all frequencies are complete.
7. The test frequency range from 9KHz to 25GHz per FCC PART 15.33(a).

Note:

For battery operated equipment, the equipment tests shall be performed using a new battery.

4.4 Test Result

PASS



Below 1GHz Test Results:

Antenna polarity: H

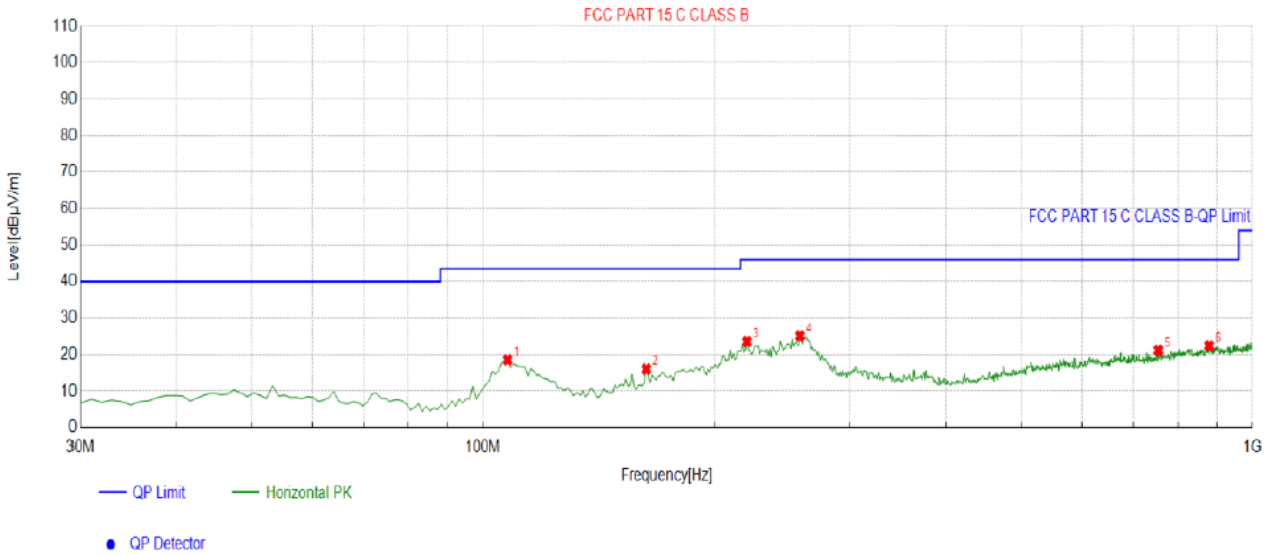

| Suspected List | | | | | | | | | |
|----------------|-------------|-------------|------------------|----------------|----------------|-------------|-------------|-----------|------------|
| NO. | Freq. [MHz] | Factor [dB] | Reading [dBµV/m] | Level [dBµV/m] | Limit [dBµV/m] | Margin [dB] | Height [cm] | Angle [°] | Polarity |
| 1 | 107.6777 | -15.42 | 33.97 | 18.55 | 43.50 | 24.95 | 100 | 234 | Horizontal |
| 2 | 163.0230 | -17.94 | 33.96 | 16.02 | 43.50 | 27.48 | 100 | 32 | Horizontal |
| 3 | 220.3103 | -14.55 | 38.13 | 23.58 | 46.00 | 22.42 | 100 | 214 | Horizontal |
| 4 | 258.1782 | -13.50 | 38.64 | 25.14 | 46.00 | 20.86 | 100 | 266 | Horizontal |
| 5 | 754.3443 | -3.62 | 24.78 | 21.16 | 46.00 | 24.84 | 100 | 163 | Horizontal |
| 6 | 878.6286 | -2.09 | 24.50 | 22.41 | 46.00 | 23.59 | 100 | 1 | Horizontal |

Remark: Factor = Cable loss + Antenna factor – Pre-amplifier; Level = Reading + Factor; Margin = Limit – Level



Antenna polarity: V

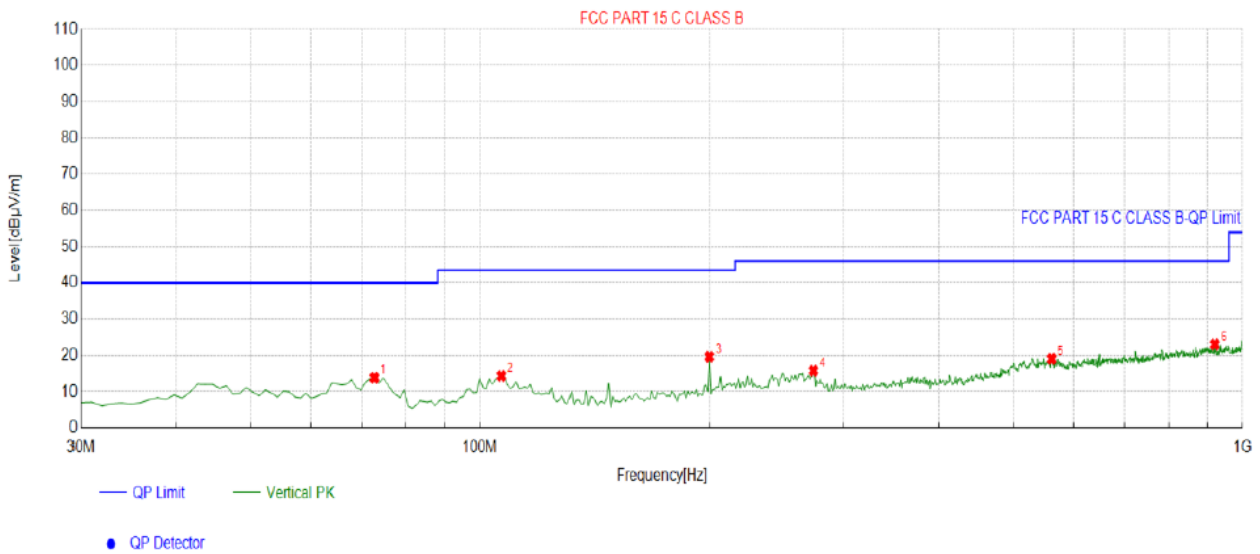

| Suspected List | | | | | | | | | |
|----------------|-------------|-------------|------------------|----------------|----------------|-------------|-------------|-----------|----------|
| NO. | Freq. [MHz] | Factor [dB] | Reading [dBµV/m] | Level [dBµV/m] | Limit [dBµV/m] | Margin [dB] | Height [cm] | Angle [°] | Polarity |
| 1 | 72.7227 | -18.16 | 32.00 | 13.84 | 40.00 | 26.16 | 100 | 201 | Vertical |
| 2 | 106.7067 | -15.42 | 29.75 | 14.33 | 43.50 | 29.17 | 100 | 161 | Vertical |
| 3 | 199.9199 | -15.07 | 34.75 | 19.68 | 43.50 | 23.82 | 100 | 19 | Vertical |
| 4 | 273.7137 | -13.51 | 29.31 | 15.80 | 46.00 | 30.20 | 100 | 288 | Vertical |
| 5 | 562.0921 | -6.62 | 25.69 | 19.07 | 46.00 | 26.93 | 100 | 324 | Vertical |
| 6 | 919.4094 | -1.79 | 24.82 | 23.03 | 46.00 | 22.97 | 100 | 59 | Vertical |

Remark: Factor = Cable loss + Antenna factor – Pre-amplifier; Level = Reading + Factor; Margin = Limit – Level

Remark:

- (1) Measuring frequencies from 9 KHz to the 1 GHz, Radiated emission test from 9KHz to 30MHz was verified, and no any emission was found except system noise floor.
- (2) * denotes emission frequency which appearing within the Restricted Bands specified in provision of 15.205, then the general radiated emission limits in 15.209 apply.
- (3) The IF bandwidth of EMI Test Receiver between 30MHz to 1GHz was 120KHz, 1 MHz for measuring above 1 GHz, below 30MHz was 10KHz.



Above 1 GHz Test Results:

CH High (2478MHz)

Horizontal:

| Frequency (MHz) | Meter Reading (dBµV) | Factor (dB) | Emission Level (dBµV/m) | Limits (dBµV/m) | Margin (dB) | Detector Type |
|--------------------|----------------------------|----------------|----------------------------|--------------------|----------------|------------------|
| 2478 | 101.25 | -5.84 | 95.41 | 114 | -18.59 | peak |
| 2478 | 88.14 | -5.84 | 82.3 | 94 | -11.7 | AVG |
| 4956 | 59.32 | -3.64 | 55.68 | 74 | -18.32 | peak |
| 4956 | 44.62 | -3.64 | 40.98 | 54 | -13.02 | AVG |
| 7434 | 56.78 | -0.95 | 55.83 | 74 | -18.17 | peak |
| 7434 | 44.05 | -0.95 | 43.1 | 54 | -10.9 | AVG |

Remark: Factor = Antenna Factor + Cable Loss – Pre-amplifier.

Vertical:

| Frequency (MHz) | Meter Reading (dBµV) | Factor (dB) | Emission Level (dBµV/m) | Limits (dBµV/m) | Margin (dB) | Detector Type |
|--------------------|----------------------------|----------------|----------------------------|--------------------|----------------|------------------|
| 2478 | 102.98 | -5.84 | 97.14 | 114 | -16.86 | peak |
| 2478 | 85.34 | -5.84 | 79.5 | 94 | -14.5 | AVG |
| 4956 | 60.41 | -3.64 | 56.77 | 74 | -17.23 | peak |
| 4956 | 45.32 | -3.64 | 41.68 | 54 | -12.32 | AVG |
| 7434 | 56.78 | -0.95 | 55.83 | 74 | -18.17 | peak |
| 7434 | 38.59 | -0.95 | 37.64 | 54 | -16.36 | AVG |

Remark: Factor = Antenna Factor + Cable Loss – Pre-amplifier.

Remark :

- (1) Measuring frequencies from 1 GHz to the 25 GHz .
- (2) "F" denotes fundamental frequency; "H" denotes spurious frequency. "E" denotes band edge frequency.
- (3) * denotes emission frequency which appearing within the Restricted Bands specified in provision of 15.205, then the general radiated emission limits in 15.209 apply.
- (4) The emissions are attenuated more than 20dB below the permissible limits are not record in the report.
- (5) The IF bandwidth of EMI Test Receiver between 30MHz to 1GHz was 120KHz, 1 MHz for measuring above 1 GHz, below 30MHz was 10KHz. The resolution bandwidth of test receiver/spectrum analyzer is 1MHz and video bandwidth is 3MHz for peak measurement with peak detector at frequency above 1GHz. The resolution bandwidth of test receiver/spectrum analyzer is 1MHz and video bandwidth is 10Hz for Average measurement with peak detection at frequency above 1GHz.
- (6) When the test results of Peak Detected below the limits of Average Detected, the Average Detected is not need completed. For example: Top Channel at Fundamental 73.16dBuV/m(PK Value) <93.98(AV Limit), at harmonic 53.20 dBuV/m(PK Value) <54 dBuV/m(AV Limit), the Average Detected not need to completed.
- (7) All modes of operation were investigated and the worst-case emissions are reported.

The results shown in this test report refer only to the sample(s) tested unless otherwise stated and the sample(s) are retained for 30 days only. The document is issued by HUAKE, this document cannot be reproduced except in full with our prior written permission. The more details and the authenticity of the report will be confirmed at <http://www.cer-mark.com>.



5 BAND EDGE

5.1 Limits

FCC PART 15.249(d) Emissions radiated outside of the specified frequency bands, except for harmonics, shall be attenuated by at least 50 dB below the level of the fundamental or to the general radiated emission limits in §15.209, whichever is the lesser attenuation.

5.2 Test Procedure

The band edge compliance of RF radiated emission should be measured by following the guidance in ANSI C63.10 with respect to maximizing the emission by rotating the EUT, measuring the emission while the EUT is situated in three orthogonal planes (if appropriate), adjusting the measurement antenna height and polarization etc. Set RBW to 1MHz and VBM to 3MHz to measure the peak field strength and set RBW to 1MHz and VBW to 10Hz to measure the average radiated field strength. The conducted RF band edge was measured by using a spectrum analyzer. Set span wide enough to capture the highest in-band emission and the emission at the band edge. Set RBW to 1MHz and VBW to 3MHz, to measure the conducted peak band edge.



5.3 Test Result

PASS

Radiated Band Edge Test:

Operation Mode: TX CH High (2478MHz)

Horizontal (Worst case)

| Frequency | Meter Reading | Factor | Emission Level | Limits | Margin | Detector Type |
|-----------|---------------|--------|----------------|----------|--------|---------------|
| (MHz) | (dBμV) | (dB) | (dBμV/m) | (dBμV/m) | (dB) | |
| 2480 | 55.03 | -3.38 | 51.65 | 74 | -22.35 | peak |
| 2480 | / | -2.99 | / | 54 | / | AVG |

Remark: Factor = Antenna Factor + Cable Loss – Pre-amplifier.

Vertical:

| Frequency | Meter Reading | Factor | Emission Level | Limits | Margin | Detector Type |
|-----------|---------------|--------|----------------|----------|--------|---------------|
| (MHz) | (dBμV) | (dB) | (dBμV/m) | (dBμV/m) | (dB) | |
| 2480 | 54.12 | -3.38 | 50.74 | 74 | -23.26 | peak |
| 2480 | / | -2.99 | / | 54 | / | AVG |

Remark: Factor = Antenna Factor + Cable Loss – Pre-amplifier.

Remark: All the other emissions not reported were too low to read and deemed to comply with FCC limit.



6 OCCUPIED BANDWIDTH MEASUREMENT

6.1 Test Setup

Same as Radiated Emission Measurement

6.2 Test Procedure

1. The EUT was placed on a turn table which is 0.8m above ground plane.
2. Set EUT as normal operation.
3. Based on ANSI C63.10 section 6.9.2: RBW= 30KHz. VBW= 100 KHz, Span=3MHz.
4. The useful radiated emission from the EUT was detected by the spectrum analyser with peak detector.

6.3 Measurement Equipment Used

Same as Radiated Emission Measurement

6.4 Test Result

PASS

| Frequency | 20dB Bandwidth (MHz) | Result |
|-----------|----------------------|-------------|
| 2478 MHz | 1.285 | PASS |

CH: 2478 MHz

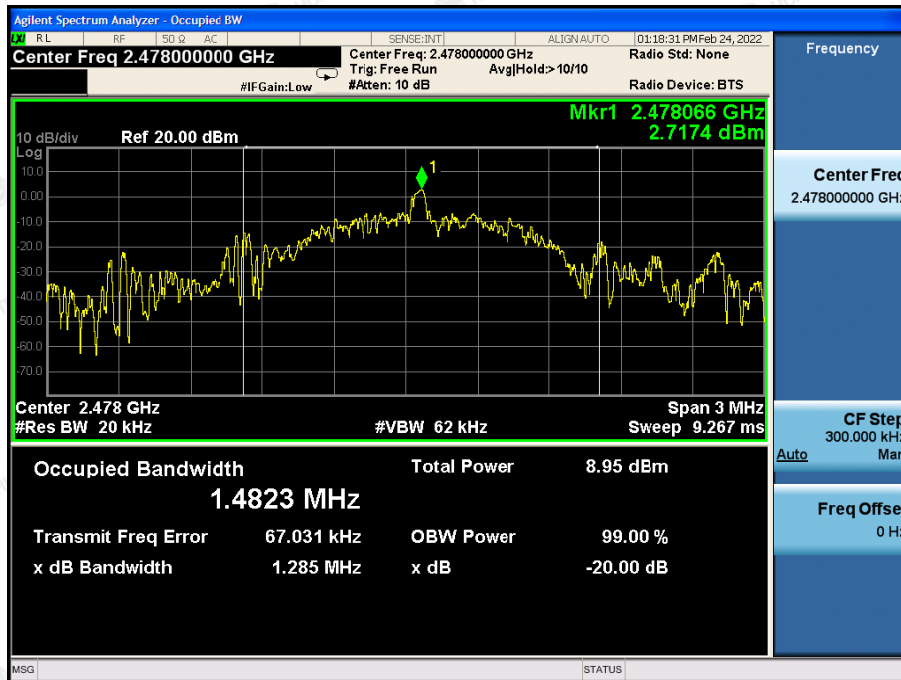

The results shown in this test report refer only to the sample(s) tested unless otherwise stated and the sample(s) are retained for 30 days only. The document is issued by HUAKE, this document cannot be reproduced except in full with our prior written permission. The more details and the authenticity of the report will be confirmed at <http://www.cer-mark.com>.

7 ANTENNA REQUIREMENT

Standard Applicable

For intentional device, according to FCC 47 CFR Section 15.203, an intentional radiator shall be designed to ensure that no antenna other than that furnished by the responsible party shall be used with the device.

Antenna Connected Construction

The antenna used in this product is a Internal Antenna which permanently attached. It conforms to the standard requirements, The directional gains of antenna used for transmitting is 0dBi.

ANTENNA

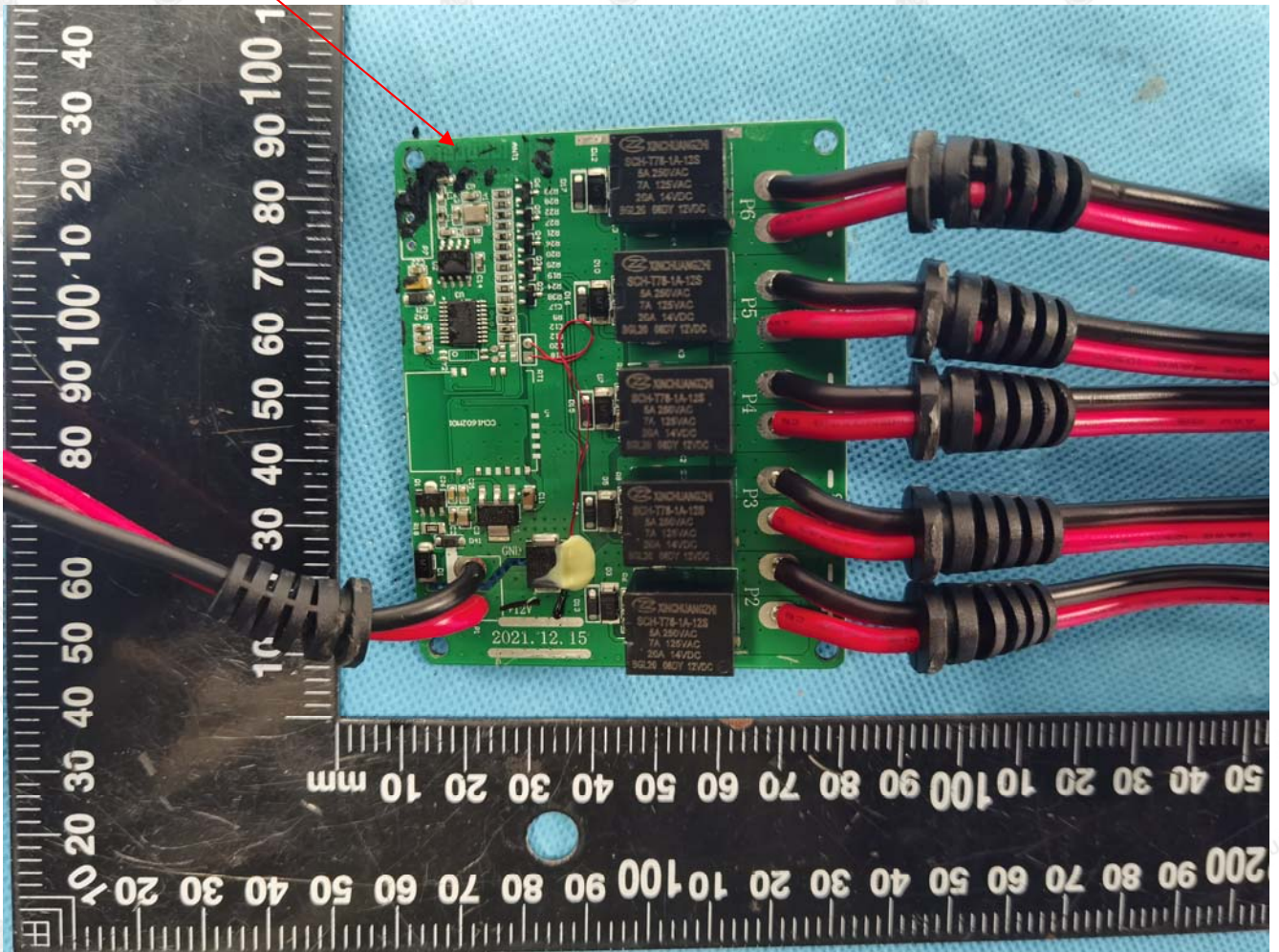



8 PHOTOGRAPH OF TEST

8.1 Radiated Emission

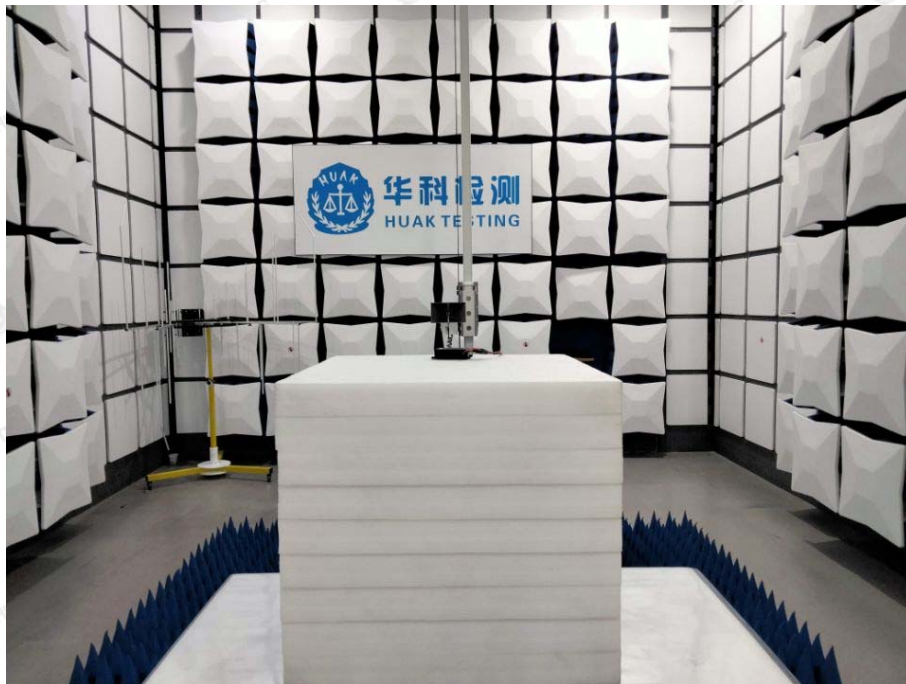
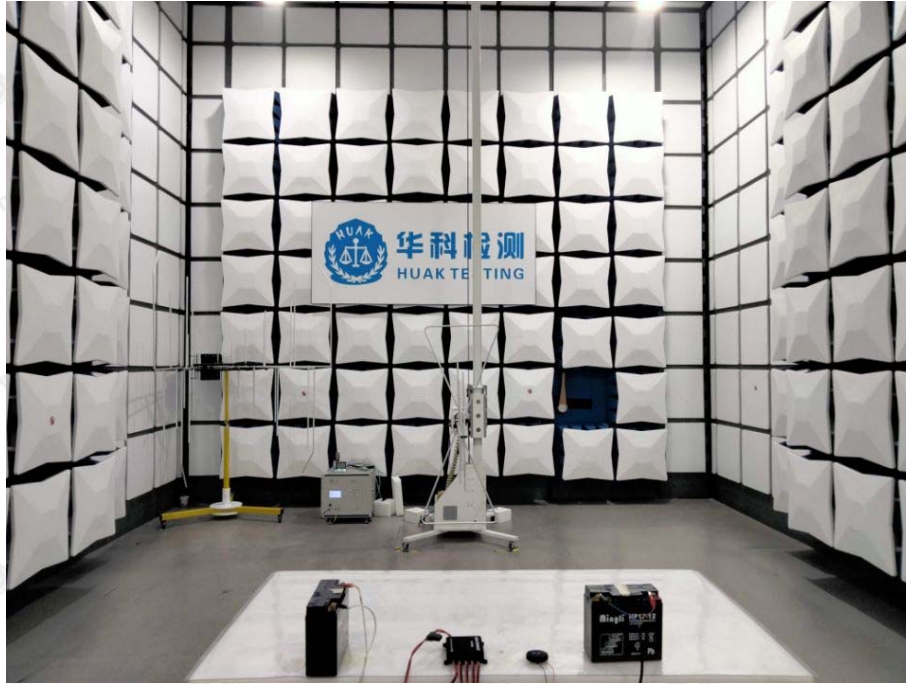

The results shown in this test report refer only to the sample(s) tested unless otherwise stated and the sample(s) are retained for 30 days only. The document is issued by HUAK, this document cannot be reproduced except in full with our prior written permission. The more details and the authenticity of the report will be confirmed at <http://www.cer-mark.com>.

HUAK Testing Lab TEL : +86-755 2302 9901 FAX : +86-755 2302 9901 E-mail : service@cer-mark.com

1-2/F., Building B2, Junfeng Zhongcheng Zhizao Innovation Park, Heping, Fuhai Street, Bao'an District, Shenzhen, Guangdong, China



9 PHOTOS OF THE EUT

Reference to the report: ANNEX A of external photos and ANNEX B of internal photos

-----End of test report-----