

**FCC PART 15 SUBPART C TEST REPORT**

**FCC PART 15 SUBPART E 15.407**

**Report Reference No.**.....: **MTEB23040075-R3**

**FCC ID**.....: **2A4WZ-WS01M1**

Compiled by

( position+printed name+signature)..:

File administrators Alisa Luo



Supervised by

( position+printed name+signature)..:

Test Engineer Sunny Deng



Approved by

( position+printed name+signature)..:

Manager Yvette Zhou



Date of issue.....: April 14, 2023

**Representative Laboratory Name.:** **Shenzhen Most Technology Service Co., Ltd.**

Address.....: No.5, 2nd Langshan Road, North District, Hi-tech Industrial Park,  
Nanshan, Shenzhen, Guangdong, China.

**Applicant's name**.....: **ENGINE TECHNOLOGY LIMITED**

Address.....: No.2, Hangtian South Road, Longquanyi District, Chengdu City,  
Sichuan Province

**Test specification**.....:

Standard.....: **FCC Part 15 Subpart E 15.407**

**Shenzhen Most Technology Service Co., Ltd. All rights reserved.**

This publication may be reproduced in whole or in part for non-commercial purposes as long as the Shenzhen Most Technology Service Co., Ltd. is acknowledged as copyright owner and source of the material. Shenzhen Most Technology Service Co., Ltd. takes no responsibility for and will not assume liability for damages resulting from the reader's interpretation of the reproduced material due to its placement and context.

**Test item description**.....: **ULTRA SHORT FOCAL INTELLIGENT PROJECTOR**

Trade Mark.....:



**Manufacturer**.....: **ENGINE TECHNOLOGY LIMITED**

Model/Type reference.....: WS01-M10

Listed Models.....: WS01-M11,WS01-M12

Ratings.....: DC 19V by Adapter  
 (Input: AC 100-240V~50/60Hz 1.8A MAX  
 Output: DC 19V=3.78A)

Modulation.....: OFDM

Frequency.....: From 5180MHz-5240MHz

Hardware version.....: P9\_MAIN\_V2.X

Software version.....: 2.X.X.X\_XXXXXXX

Result.....: **PASS**

**TEST REPORT**

Equipment under Test : Ultra short focal Intelligent projector

Model /Type : WS01-M10

Listed Models : WS01-M11,WS01-M12

Remark : Only the appearance color and outer packaging are different.

**Applicant** : **ENGINE TECHNOLOGY LIMITED**

Address : No.2, Hangtian South Road, Longquanyi District, Chengdu City,  
Sichuan Province

**Manufacturer** : **ENGINE TECHNOLOGY LIMITED**

Address : No.2, Hangtian South Road, Longquanyi District, Chengdu City,  
Sichuan Province

**Test Result:****PASS**

The test report merely corresponds to the test sample.  
It is not permitted to copy extracts of these test result without the written permission of the test laboratory.

## Contents

|                           |          |
|---------------------------|----------|
| <b>1 REVISION HISTORY</b> | <b>4</b> |
| <b>2 TEST STANDARDS</b>   | <b>5</b> |
| <b>3 SUMMARY</b>          | <b>6</b> |

### 目录

|  |    |
|--|----|
| TEST REPORT                              | 2  |
| Applicant: ENGINE TECHNOLOGY LIMITED     | 2  |
| Manufacturer: ENGINE TECHNOLOGY LIMITED  | 2  |
| Test Result: PASS                        | 2  |
| Contents                                 | 3  |
| 1 Revision History                       | 5  |
| 3 SUMMARY                                | 7  |
| 3.1 General Remarks                      | 7  |
| 3.2 Product Description                  | 7  |
| 3.5 EUT operation mode                   | 8  |
| 3.2 Auxiliary Equipment (AE) Description | 8  |
| 3.4 Related Submittal(s) / Grant (s)     | 8  |
| 3.5 Modifications                        | 8  |
| 4 TEST ENVIRONMENT                       | 9  |
| 4.1 Address of the test laboratory       | 9  |
| 4.2 Test Facility                        | 9  |
| 4.3 Environmental conditions             | 9  |
| 4.4 Test Description                     | 10 |
| 4.6 Equipments Used during the Test      | 11 |
| 7 TEST CONDITIONS AND RESULTS            | 12 |
| 7.1 AC Power Conducted Emission          | 12 |
| 7.2 Radiated Emissions                   | 15 |
| Limit                                    | 15 |
| 30P                                      | 15 |
| TEST CONFIGURATION                       | 16 |
| 7.5 Power Spectral Density               | 31 |
| Test Procedure                           | 31 |
| 3. Set the VBW $\geq 3 \times$ RBW       | 31 |
| Test Configuration                       | 31 |
| 7.6 Emission Bandwidth (26dBm Bandwidth) | 33 |
| 7.8 Frequency Stability                  | 41 |
| 7.9 Duty Cycle Information               | 42 |
| 7.10 Antenna Requirement                 | 43 |
| Standard Applicable                      | 43 |
| Test Result:                             | 43 |
| 8 Test Setup Photos of the EUT           | 44 |
| APPENDIX I. Frequency Stability          | 45 |
| Test Result                              | 45 |
| Test Graphs                              | 45 |
| APPENDIX II. Conducted Peak Output Power | 49 |
| APPENDIX III. 6dB Bandwidth              | 49 |
| Test Result                              | 49 |
| Test Graphs                              | 49 |
| APPENDIX IV. 26dB Bandwidth              | 52 |
| Test Result                              | 52 |
| Test Graphs                              | 52 |

APPENDIX V. Conducted Out Of Band Emission ..... 55  
Test Result .....55  
Test Graphs ..... 55  
APPENDIX VI. Duty Cycle ..... 63  
Test Result .....63  
Test Graphs ..... 63  
APPENDIX VII. Peak Power Spectral Density ..... 71  
Test Result .....71  
Test Graphs ..... 71

## 1 Revision History

| Revision | Issue Date | Revisions     | Revised By |
|----------|------------|---------------|------------|
| 00       | 2023.07.07 | Initial Issue | Alisa Luo  |
|          |            |               |            |
|          |            |               |            |

## **2 TEST STANDARDS**

The tests were performed according to following standards:

[FCC Rules Part 15 Subpart E](#)—Unlicensed National Information Infrastructure Devices  
[ANSI C63.10-2013](#): American National Standard for Testing Unlicensed Wireless Devices  
[KDB789033 D02](#): General UNII Test Procedures New Rules v01r02

### 3 SUMMARY

#### 3.1 General Remarks

|                                |   |              |
|--------------------------------|---|--------------|
| Date of receipt of test sample | : | Mar.21, 2023 |
|                                |   |              |
| Testing commenced on           | : | Mar.21, 2023 |
|                                |   |              |
| Testing concluded on           | : | Apr.06, 2023 |

#### 3.2 Product Description

|                      |  |                     |              |               |
|----------------------|--|---------------------|--------------|---------------|
| Product Description: | Ultra short focal Intelligent projector  |                     |              |               |
| Model:               | WS01-M10   |                     |              |               |
| Power supply:        | DC 19V by Adapter<br>(Input: AC 100-240V~50/60Hz 1.8A MAX<br>Output: DC 19V=3.78A) |                     |              |               |
| Testing sample ID:   | MT23030244   |                     |              |               |
| <b>WIFI</b>          |  |                     |              |               |
|                      | 20MHz system   | 40MHz system        | 80MHz system | 160MHz system |
| Supported type:      | 802.11a<br>802.11n<br>802.11ac   | 802.11n<br>802.11ac | 802.11ac     | N/A           |
| Operation frequency: | 5180MHz-5240MHz  | 5190MHz-5230MHz     | 5210MHz      | N/A           |
| Modulation:          | OFDM   | OFDM                | OFDM         | N/A           |
| Channel number:      | 4  | 2                   | 1            | N/A           |
| Antenna type:        | FPC Antenna  |                     |              |               |
| Antenna gain:        | 5180MHz-5240MHz:2.71dBi  |                     |              |               |

#### 3.3 Equipment Under Test

##### Power supply system utilised

|                      |   |   |                                   |
|----------------------|---|---|-----------------------------------|
| Power supply voltage | : | <input type="radio"/> 230V / 50 Hz                                | <input type="radio"/> 120V / 60Hz |
|                      |   | <input type="radio"/> 12 V DC                                     | <input type="radio"/> 24 V DC     |
|                      |   | <input checked="" type="radio"/> Other (specified in blank below) |                                   |

DC 19V by Adapter  
(Input: AC 100-240V~50/60Hz 1.8A MAX  
Output: DC 19V=3.78A)

#### 3.4 Short description of the Equipment under Test (EUT)

This is a Ultra short focal Intelligent projector

For more details, refer to the user's manual of the EUT.

### 3.5 EUT operation mode

The Applicant provides communication tools software (AT command) to control the EUT for staying in continuous transmitting (Duty Cycle more than 98%) and receiving mode for testing. All test performed at the low, middle and high of operational frequency range of each mode.

Operation Frequency List WIFI on 5G Band:

| Operating band               | 20MHz   |                 | 40MHz   |                 | 80MHz   |                 |
|------------------------------|---------|-----------------|---------|-----------------|---------|-----------------|
|                              | Channel | Frequency (MHz) | Channel | Frequency (MHz) | Channel | Frequency (MHz) |
| U-NII 1<br>(5150MHz-5250MHz) | 36      | 5180            | 38      | 5190            | 42      | 5210            |
|                              | 40      | 5200            |         |                 |         |                 |
|                              | 44      | 5220            | 46      | 5230            |         |                 |
|                              | 48      | 5240            |         |                 |         |                 |

Note: The line display in grey is those Channels/Frequencies select to test in this report for each operation mode.

### 3.6 Block Diagram of Test Setup

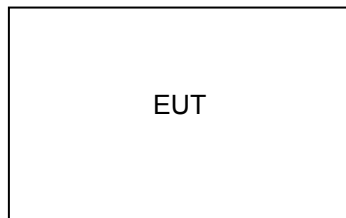

### 3.1 Test Item (Equipment Under Test) Description\*

| Short designation | EUT Name | EUT Description | Serial number | Hardware status | Software status |
|-------------------|----------|-----------------|---------------|-----------------|-----------------|
| EUT A             |          |                 |               |                 |                 |
| EUT B             |          |                 |               |                 |                 |

\*: declared by the applicant. According to customers information EUTs A and B are the same devices.

### 3.2 Auxiliary Equipment (AE) Description

| AE short designation | EUT Name (if available) | EUT Description | Serial number (if available) | Software (if used) |
|----------------------|-------------------------|-----------------|------------------------------|--------------------|
| AE 1                 | -                       |                 |                              |                    |
| AE 2                 | -                       |                 |                              |                    |

### 3.3 Antenna Information\*

| Short designation | Antenna Name | Antenna Type | Frequency Range | Serial number | Antenna Peak Gain |
|-------------------|--------------|--------------|-----------------|---------------|-------------------|
| Antenna 1         | ---          | FPC Antenna  | 5180MHz-5240MHz | ---           | 2.71dBi           |
| Antenna 2         |              |              |                 |               |                   |

\*: declared by the applicant.



### **3.4 Related Submittal(s) / Grant (s)**

This submittal(s) (test report) is intended to comply with Section 15.407 of the FCC Part 15, Subpart E Rules.

### **3.5 Modifications**

No modifications were implemented to meet testing criteria.

## 4 TEST ENVIRONMENT

### 4.1 Address of the test laboratory

Shenzhen Most Technology Service Co., Ltd.  
No.5, 2nd Langshan Road, North District, Hi-tech Industrial Park, Nanshan, Shenzhen, Guangdong, China.

The 3m-Semi anechoic test site fulfils CISPR 16-1-4 according to ANSI C63.4:2014 and CISPR 16-1-4:2010 SVSWR requirement for radiated emission above 1GHz.

### 4.2 Test Facility

The test facility is recognized, certified, or accredited by the following organizations:

The test facility is recognized, certified, or accredited by the following organizations:

#### **FCC-Registration No.: 0031192610**

Shenzhen Most Technology Service Co., Ltd. EMC Laboratory has been registered and fully described in a report filed with the (FCC) Federal Communications Commission. The acceptance letter from the FCC is maintained in our files.

#### **A2LA-Lab Cert. No.: 6343.01**

Shenzhen Most Technology Service Co., Ltd. EMC Laboratory has been accredited by A2LA for technical competence in the field of electrical testing, and proved to be in compliance with ISO/IEC 17025: 2005 General Requirements for the Competence of Testing and Calibration Laboratories and any additional program requirements in the identified field of testing.

### 4.3 Environmental conditions

Radiated Emission:

|                       |              |
|-----------------------|--------------|
| Temperature:          | 23 ° C       |
| Humidity:             | 48 %         |
| Atmospheric pressure: | 950-1050mbar |

AC Main Conducted testing:

|                       |              |
|-----------------------|--------------|
| Temperature:          | 24 ° C       |
| Humidity:             | 45 %         |
| Atmospheric pressure: | 950-1050mbar |

Conducted testing:

|                       |              |
|-----------------------|--------------|
| Temperature:          | 24 ° C       |
| Humidity:             | 45 %         |
| Atmospheric pressure: | 950-1050mbar |

#### 4.4 Test Description

| FCC Requirement                  |  |                       |
|----------------------------------|--|-----------------------|
| FCC Part 15.207                  | AC Power Conducted Emission                | PASS                  |
| FCC Part 15.407(a)               | Emission Bandwidth(26dBm Bandwidth)        | PASS <sup>Note1</sup> |
| FCC Part 15.407(e)               | Minimum Emission Bandwidth(6dBm Bandwidth) | N/A <sup>Note2</sup>  |
| FCC Part 15.407(a)               | Maximum Conducted Output Power             | PASS                  |
| FCC Part 15.407(a)               | Peak Power Spectral Density                | PASS                  |
| FCC Part 15.407(g)               | Frequency Stability                        | PASS                  |
| FCC Part 15.407(b)               | Undesirable emission                       | PASS                  |
| FCC Part 15.407(b)/15.205/15.209 | Radiated Emissions                         | PASS                  |
| FCC Part 15.407(h)               | Dynamic Frequency Selection                | N/A <sup>Note 3</sup> |
| FCC Part 15.203/15.247(b)        | Antenna Requirement                        | PASS                  |

Note 1: Apply to U-NII 1, U-NII 2A, and U-NII 2C band.

Note 2: Apply to U-NII 3 band only.

Note 3: This device not work in DFS band.

#### Data Rate Used:

Preliminary tests were performed in different data rate to find the worst radiated emission. The data rate shown in the table below is the worst-case rate with respect to the specific test item. Investigation has been done on all the possible configurations for searching the worst cases. The following table is a list of the test modes shown in this test report.

| Test Items   | Mode                        | Data Rate |
|--|-----------------------------|-----------|
| Maximum Conducted Output Power<br>Power Spectral Density<br>Emission Bandwidth(26dBm Bandwidth)<br>Minimum Emission Bandwidth(6dBm Bandwidth)<br>Undesirable emission<br>Frequency Stability | 11a/OFDM                    | 6 Mbps    |
|  | 11n(20MHz),11ac(20MHz)/OFDM | 7.2 Mbps  |
|  | 11n(40MHz),11ac(40MHz)/OFDM | 15.0Mbps  |
|  | 11ac(80MHz)/OFDM            | 65.0Mbps  |

#### 4.5 Statement of the measurement uncertainty

The data and results referenced in this document are true and accurate. The reader is cautioned that there may be errors within the calibration limits of the equipment and facilities. The measurement uncertainty was calculated for all measurements listed in this test report acc. to CISPR 16 - 4 „Specification for radio disturbance and immunity measuring apparatus and methods – Part 4: Uncertainty in EMC Measurements— and is documented in the Shenzhen Most Technology Service Co., Ltd. quality system acc. to DIN EN ISO/IEC 17025. Furthermore, component and process variability of devices similar to that tested may result in additional deviation. The manufacturer has the sole responsibility of continued compliance of the device.

Hereafter the best measurement capability for Shenzhen Most Technology Service Co., Ltd. is reported:

| Test                  | Range      | Measurement Uncertainty | Notes |
|-----------------------|------------|-------------------------|-------|
| Radiated Emission     | 30~1000MHz | 4.10 Db                 | (1)   |
| Radiated Emission     | 1~18GHz    | 4.32 Db                 | (1)   |
| Radiated Emission     | 18-40GHz   | 5.54 dB                 | (1)   |
| Conducted Disturbance | 0.15~30MHz | 3.12 dB                 | (1)   |

(1) This uncertainty represents an expanded uncertainty expressed at approximately the 95% confidence level using a coverage factor of k=2.

#### 4.6 Equipments Used during the Test

5

| Item | Equipment                            | Manufacturer     | Model No.    | Serial No. | Firmware versions | Last Cal.  | Cal. Interval |
|------|--------------------------------------|------------------|--------------|------------|-------------------|------------|---------------|
| 1.   | L.I.S.N.                             | R&S              | ENV216       | 100093     | /                 | 2023/03/17 | 1 Year        |
| 2    | Three-phase artificial power network | Schwarzback Mess | NNLK8129     | 8129178    | /                 | 2023/03/17 | 1 Year        |
| 3.   | Receiver                             | R&S              | ESCI         | 100492     | V3.0-10-2         | 2023/03/17 | 1 Year        |
| 4    | Receiver                             | R&S              | ESPI         | 101202     | V3.0-10-2         | 2023/03/17 | 1 Year        |
| 5    | Spectrum analyzer                    | Agilent          | 9020A        | MT-E306    | A14.16            | 2023/03/17 | 1 Year        |
| 6    | Bilong Antenna                       | Sunol Sciences   | JB3          | A121206    | /                 | 2023/03/17 | 1 Year        |
| 7    | Horn antenna                         | HF Antenna       | HF Antenna   | MT-E158    | /                 | 2023/03/17 | 1 Year        |
| 8    | Loop antenna                         | Beijing Daze     | ZN30900B     | /          | /                 | 2023/03/17 | 1 Year        |
| 9    | Horn antenna                         | R&S              | OBH100400    | 26999002   | /                 | 2023/03/17 | 1 Year        |
| 10   | Wireless Communication Test Set      | R&S              | CMW500       | /          | CMW-BASE-3.7.21   | 2023/03/17 | 1 Year        |
| 11   | Spectrum analyzer                    | R&S              | FSP          | 100019     | V4.40 SP2         | 2023/03/17 | 1 Year        |
| 12   | High gain antenna                    | Schwarzbeck      | LB-180400KF  | MT-E389    | /                 | 2023/03/17 | 1 Year        |
| 13   | Preamplifier                         | Schwarzbeck      | BBV 9743     | MT-E390    | /                 | 2023/03/17 | 1 Year        |
| 14   | Pre-amplifier                        | EMCI             | EMC051845S E | MT-E391    | /                 | 2023/03/17 | 1 Year        |
| 15   | Pre-amplifier                        | Agilent          | 83051A       | MT-E392    | /                 | 2023/03/17 | 1 Year        |
| 16   | High pass filter unit                | Tonscend         | JS0806-F     | MT-E393    | /                 | 2023/03/17 | 1 Year        |
| 17   | RF Cable(below1GHz)                  | Times            | 9kHz-1GHz    | MT-E394    | /                 | 2023/03/17 | 1 Year        |
| 18   | RF Cable(above 1GHz)                 | Times            | 1-40G        | MT-E395    | /                 | 2023/03/17 | 1 Year        |
| 19   | RF Cable (9KHz-40GHz)                | Tonscend         | 170660       | N/A        | /                 | 2023/03/17 | 1 Year        |

6 Note: The Cal.Interval was one year.

## 7 TEST CONDITIONS AND RESULTS

### 7.1 AC Power Conducted Emission

#### TEST CONFIGURATION

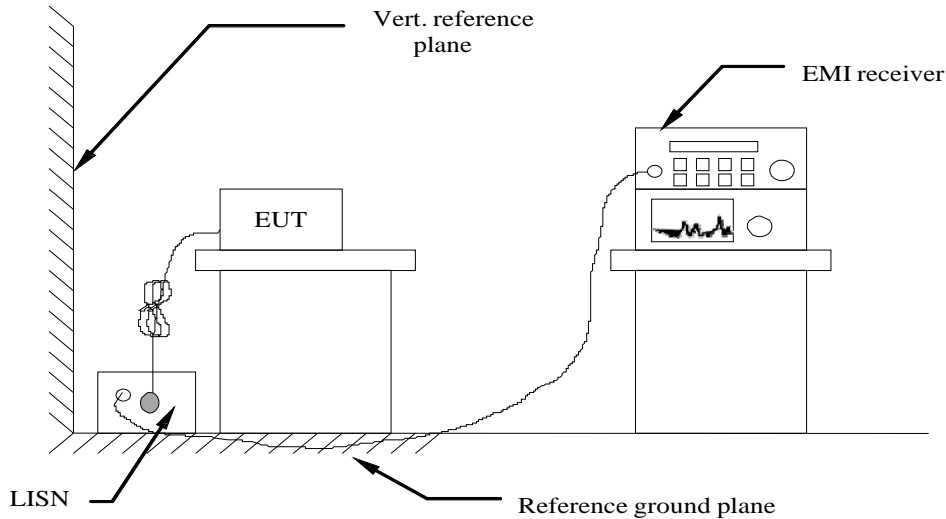

#### TEST PROCEDURE

- 1 The equipment was set up as per the test configuration to simulate typical actual usage per the user's manual. The EUT is a tabletop system, a wooden table with a height of 0.8 meters is used and is placed on the ground plane as per ANSI C63.10-2013.
- 2 Support equipment, if needed, was placed as per ANSI C63.10-2013
- 3 All I/O cables were positioned to simulate typical actual usage as per ANSI C63.10-2013
- 4 The EUT received DC 12V power from adapter, the adapter received AC120V/60Hz and AC 240V/60Hz power through a Line Impedance Stabilization Network (LISN) which supplied power source and was grounded to the ground plane.
- 5 All support equipments received AC power from a second LISN, if any.
- 6 The EUT test program was started. Emissions were measured on each current carrying line of the EUT using a spectrum Analyzer / Receiver connected to the LISN powering the EUT. The LISN has two monitoring points: Line 1 (Hot Side) and Line 2 (Neutral Side). Two scans were taken: one with Line 1 connected to Analyzer / Receiver and Line 2 connected to a 50 ohm load; the second scan had Line 1 connected to a 50 ohm load and Line 2 connected to the Analyzer / Receiver.
- 7 Analyzer / Receiver scanned from 150 KHz to 30MHz for emissions in each of the test modes.
- 8 During the above scans, the emissions were maximized by cable manipulation.

#### AC Power Conducted Emission Limit

For intentional device, according to § 15.207(a) AC Power Conducted Emission Limits is as following :

| Frequency range (MHz) | Limit (dBuV) |           |
|-----------------------|--------------|-----------|
|                       | Quasi-peak   | Average   |
| 0.15-0.5              | 66 to 56*    | 56 to 46* |
| 0.5-5                 | 56           | 46        |
| 5-30                  | 60           | 50        |

\* Decreases with the logarithm of the frequency.

#### TEST RESULTS

Remark:

1. All modes were test at Low, Middle, and High channel; only the worst result of 802.11a Middle Channel was reported as below:

2. Remark: Result=Reading value+Factor,and Margin=Limit- Result

Power Supply

DC 5V (by USB)

Line

L

Power Supply

DC 5V (by USB)

Line

N

## 7.2 Radiated Emissions

### Limit

The maximum emissions outside of the frequency bands of operation shall be attenuated in accordance with the following limits:

- (1) For transmitters operating in the 5.15-5.25 GHz band: All emissions outside of the 5.15-5.35 GHz band shall not exceed an e.i.r.p. of -27 dBm/MHz.
- (2) For transmitters operating in the 5.25-5.35 GHz band: All emissions outside of the 5.15-5.35 GHz band shall not exceed an e.i.r.p. of -27 dBm/MHz.
- (3) For transmitters operating in the 5.47-5.725 GHz band: All emissions outside of the 5.47-5.725 GHz band shall not exceed an e.i.r.p. of -27 dBm/MHz.
- (4) For transmitters operating in the 5.725-5.85 GHz band: All emissions shall be limited to a level of -27 dBm/MHz at 75 MHz or more above or below the band edge increasing linearly to 10 dBm/MHz at 25 MHz above or below the band edge, and from 25 MHz above or below the band edge increasing linearly to a level of 15.6 dBm/MHz at 5 MHz above or below the band edge, and from 5 MHz above or below the band edge increasing linearly to a level of 27 dBm/MHz at the band edge.

#### Undesirable emission limits

| Requirement  | Limit(EIRP)     | Limit (Field strength at 3m) <small>Note1</small> |
|--------------|-----------------|---|
| 15.407(b)(1) | PK:-27(dBm/MHz) | PK:68.2(dBμV/m)                                   |
| 15.407(b)(2) |                 |   |
| 15.407(b)(3) |                 |   |
| 15.407(b)(4) |                 |   |

Note1: The following formula is used to convert the equipment isotropic radiated power (eirp) to field strength:

$$E = \frac{1000000\sqrt{30P}}{3} \mu\text{V/m, where P is the eirp (Watts)}$$

- (5) Unwanted emissions below 1 GHz must comply with the general field strength limits set forth in §15.209
- (6) In addition, radiated emissions which fall in the restricted bands, as defined in §15.205(a), must also comply with the radiated emission limits specified in §15.209(a)

#### Radiated emission limits

| Frequency (MHz) | Distance (Meters) | Radiated (dBμV/m)                | Radiated (μV/m) |
|-----------------|-------------------|----------------------------------|-----------------|
| 0.009-0.49      | 3                 | 20log(2400/F(KHz))+40log(300/3)  | 2400/F(KHz)     |
| 0.49-1.705      | 3                 | 20log(24000/F(KHz))+ 40log(30/3) | 24000/F(KHz)    |
| 1.705-30        | 3                 | 20log(30)+ 40log(30/3)           | 30              |
| 30-88           | 3                 | 40.0                             | 100             |
| 88-216          | 3                 | 43.5                             | 150             |
| 216-960         | 3                 | 46.0                             | 200             |
| Above 960       | 3                 | 54.0                             | 500             |



**TEST CONFIGURATION**

(A) Radiated Emission Test Set-Up, Frequency Below 30MHz

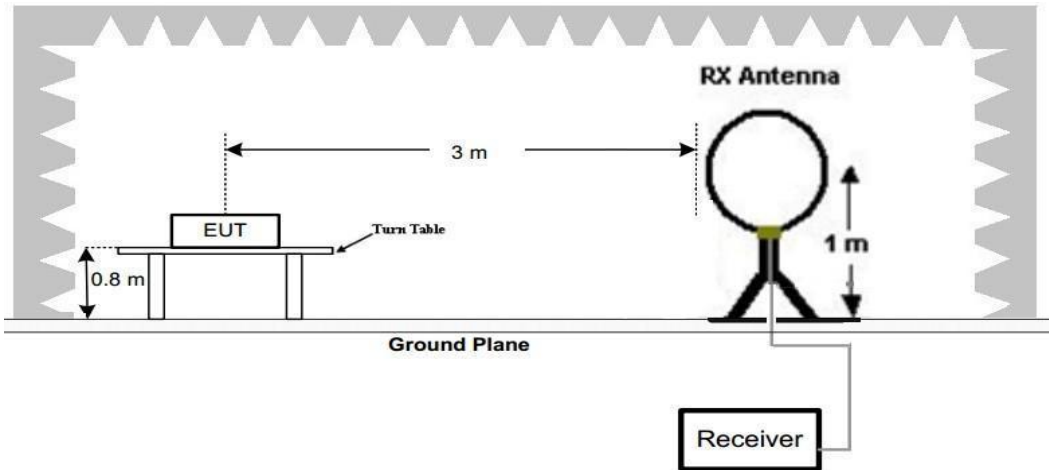

(B) Radiated Emission Test Set-Up, Frequency below 1000MHz

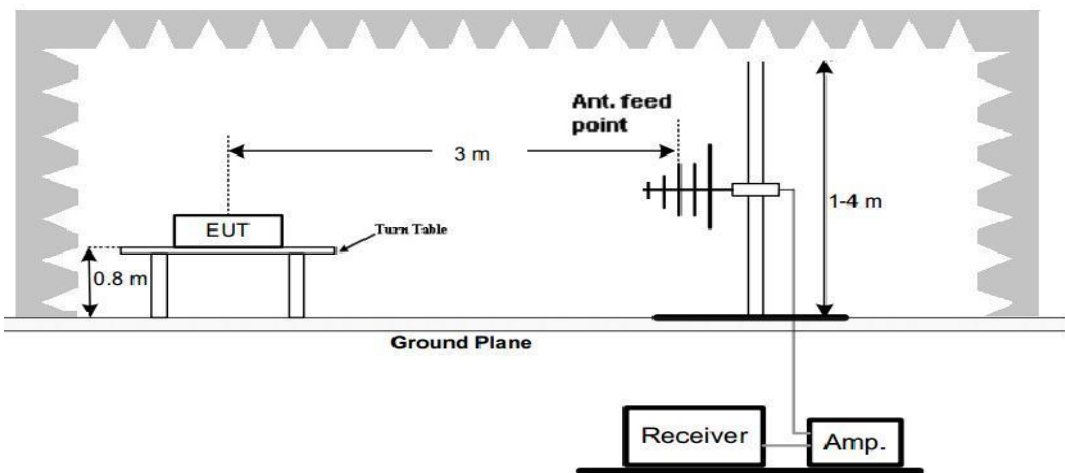

(C) Radiated Emission Test Set-Up, Frequency above 1000MHz

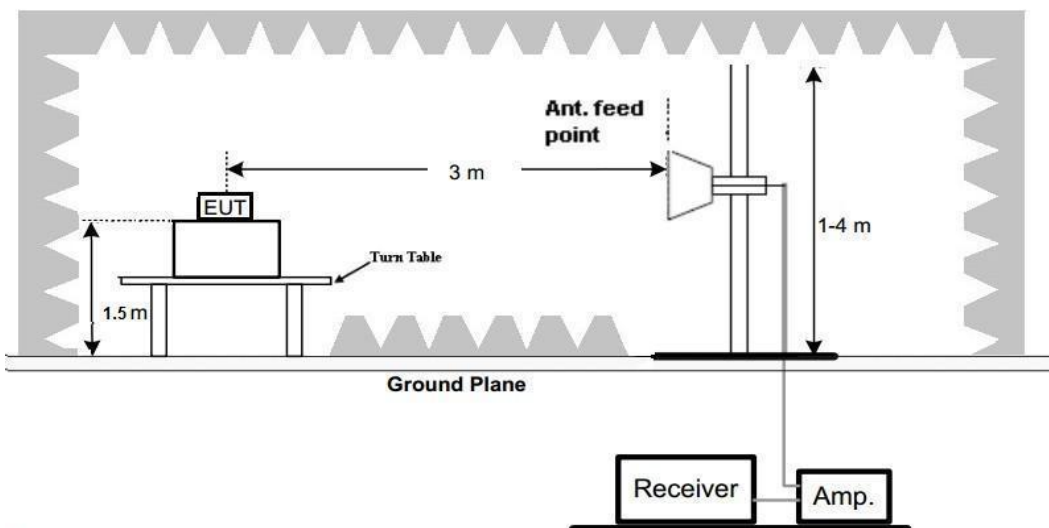

**Test Procedure**

1. Below 1GHz measurement the EUT is placed on a turntable which is 0.8m above ground plane, and above 1GHz measurement EUT was placed on a low permittivity and low loss tangent turn table which is 1.5m above ground plane.
2. Maximum procedure was performed by raising the receiving antenna from 1m to 4m and rotating the turn table from 0° to 360° to acquire the highest emissions from EUT
3. And also, each emission was to be maximized by changing the polarization of receiving antenna both horizontal and vertical.
4. Repeat above procedures until all frequency measurements have been completed.
5. Radiated emission test frequency band from 9KHz to 40GHz.
6. The distance between test antenna and EUT as following table states:

| Test Frequency range | Test Antenna Type   | Test Distance |
|----------------------|---------------------|---------------|
| 9KHz-30MHz           | Active Loop Antenna | 3             |
| 30MHz-1GHz           | Bilog Antenna       | 3             |
| 1GHz-18GHz           | Horn Antenna        | 3             |
| 18GHz-25GHz          | Horn Antenna        | 1             |

7. Setting test receiver/spectrum as following table states:

| Test Frequency range | Test Receiver/Spectrum Setting  | Detector |
|----------------------|---|----------|
| 9KHz-150KHz          | RBW=200Hz/VBW=3KHz, Sweep time=Auto   | QP       |
| 150KHz-30MHz         | RBW=9KHz/VBW=100KHz, Sweep time=Auto  | QP       |
| 30MHz-1GHz           | RBW=120KHz/VBW=1000KHz, Sweep time=Auto   | QP       |
| 1GHz-40GHz           | Peak Value: RBW=1MHz/VBW=3MHz,<br>Sweep time=Auto<br>Average Value: RBW=1MHz/VBW=10Hz,<br>Sweep time=Auto | Peak     |

**TEST RESULTS**

Remark:

1. This test was performed with EUT in X, Y, Z position and the worse case was found when EUT in X position.
  1. All 802.11a / 802.11n (HT20) / 802.11n (HT40) modes have been tested for below 1GHz test, only the worst case 802.11a low channel of U-NII 1 band was recorded.
  2. All 802.11a / 802.11n (HT20) / 802.11n (HT40) modes have been tested for above 1GHz test, only the worst case 802.11a was recorded.
  3. Radiated emission test from 9 KHz to 10th harmonic of fundamental was verified, and no emission found except system noise floor in 9 KHz to 30MHz and not recorded in this report.
  4. Remark: Result=Reading value+Factor

For 30MHz-1GHz

Horizontal

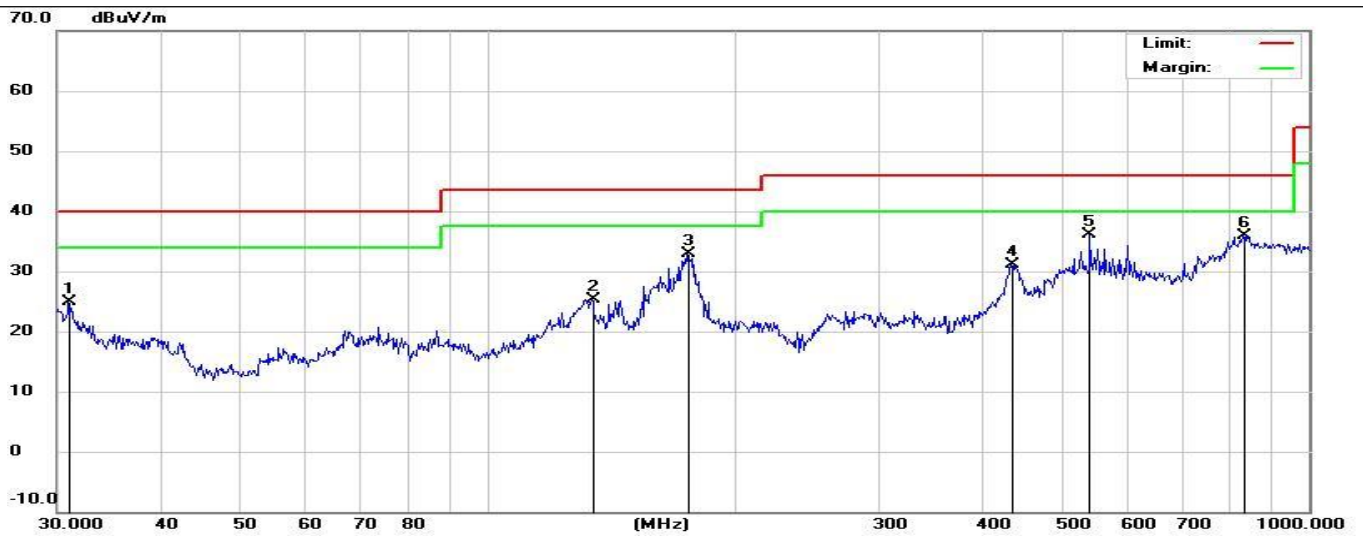

| No. | Mk. | Freq.<br>MHz | Reading<br>Level<br>dBuV | Correct<br>Factor<br>dB | Measure-<br>ment<br>dBuV/m | Limit<br>dBuV/m | Over<br>dB | Detector | Antenna<br>Height<br>cm | Table<br>Degree | Comment |
|-----|-----|--------------|--------------------------|-------------------------|----------------------------|-----------------|------------|----------|-------------------------|-----------------|---------|
| 1   |     | 30.9619      | 4.57                     | 20.25                   | 24.82                      | 40.00           | -15.18     | QP       | 200                     | 288             |         |
| 2   |     | 134.0882     | 9.09                     | 16.24                   | 25.33                      | 43.50           | -18.17     | QP       | 200                     | 254             |         |
| 3   |     | 175.0368     | 16.17                    | 16.78                   | 32.95                      | 43.50           | -10.55     | QP       | 200                     | 247             |         |
| 4   |     | 434.0651     | 11.83                    | 19.21                   | 31.04                      | 46.00           | -14.96     | QP       | 200                     | 197             |         |
| 5   | *   | 541.3725     | 12.92                    | 23.16                   | 36.08                      | 46.00           | -9.92      | QP       | 200                     | 157             |         |
| 6   |     | 830.4002     | 7.69                     | 28.23                   | 35.92                      | 46.00           | -10.08     | QP       | 200                     | 87              |         |

\*:Maximum data    x:Over limit    !:over margin

\*:Maximum data x:Over limit !:over margin

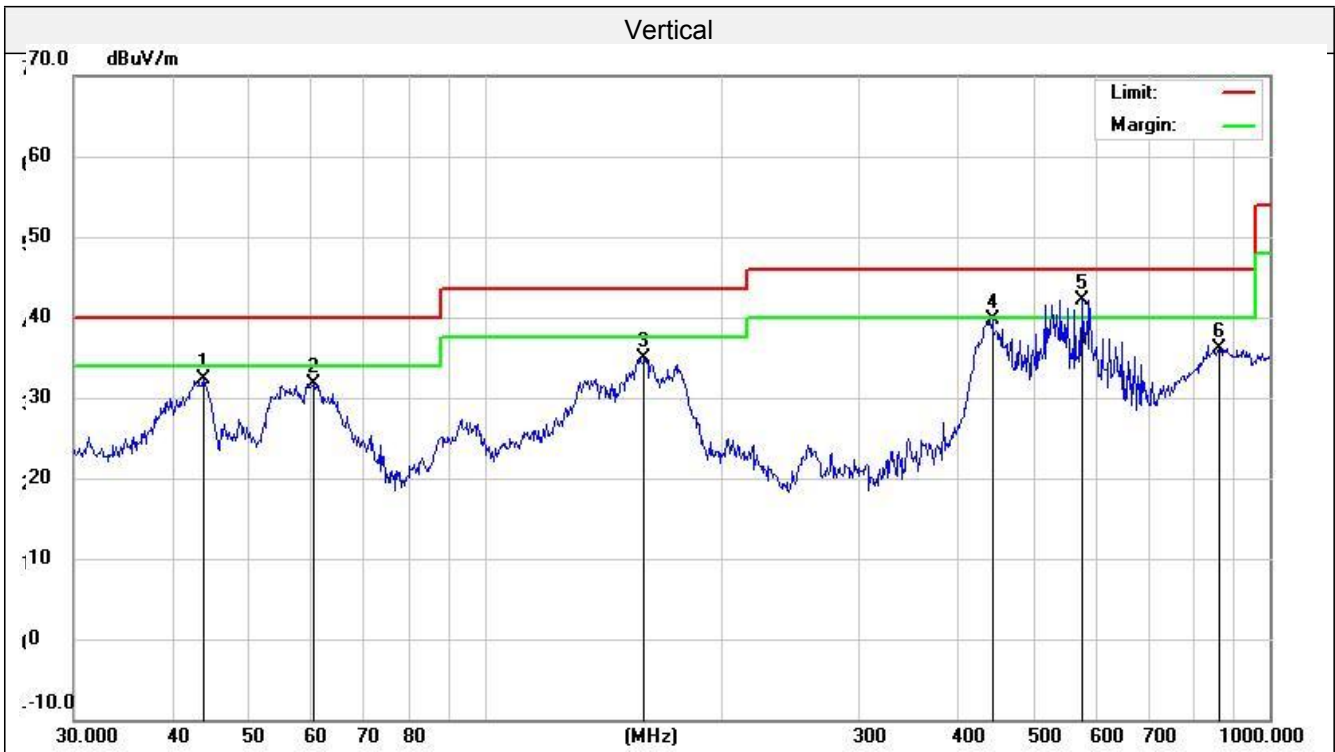

| No. | Mk. | Freq.    | Reading Level | Correct Factor | Measurement | Limit  | Over  | Antenna Height | Table Degree |         |
|-----|-----|----------|---------------|----------------|-------------|--------|-------|----------------|--------------|---------|
|     |     | MHz      | dBuV          | dB             | dBuV/m      | dBuV/m | dB    | cm             | degree       | Comment |
| 1   |     | 43.8119  | 21.10         | 11.28          | 32.38       | 40.00  | -7.62 | QP             | 100          | 265     |
| 2   |     | 60.4919  | 23.15         | 8.63           | 31.78       | 40.00  | -8.22 | QP             | 100          | 119     |
| 3   |     | 159.7844 | 17.63         | 17.31          | 34.94       | 43.50  | -8.56 | QP             | 100          | 120     |
| 4   |     | 443.2943 | 20.10         | 19.69          | 39.79       | 46.00  | -6.21 | QP             | 100          | 158     |
| 5   | *   | 576.6443 | 18.66         | 23.54          | 42.20       | 46.00  | -3.80 | QP             | 100          | 258     |
| 6   |     | 863.0562 | 7.50          | 28.59          | 36.09       | 46.00  | -9.91 | QP             | 100          | 305     |

\*:Maximum data x:Over limit !:over margin

**For 1GHz to 40GHz**

Note: All 802.11a / 802.11n (HT20) /802.11n (HT40)/ 802.11ac (HT20)/ 802.11ac (HT40)/ 802.11ac (HT80) modes have been tested for above 1GHz test, only the worst case 802.11a was recorded.

| Polar (H/V)                  | Frequency | Meter Reading | Antenna Factor | Cable loss | Preamp factor | Emission Level | Limits   | Margin | Detector Type |
|------------------------------|-----------|---------------|----------------|------------|---------------|----------------|----------|--------|---------------|
|                              | (MHz)     | (dBuV)        | (dB)           | (dB)       | (dB)          | (dBuV/m)       | (dBuV/m) | (dB)   |               |
| <b>802.11a Mode -5180MHz</b> |           |               |                |            |               |                |          |        |               |
| V                            | 3467      | 57.17         | 29.03          | 5.24       | 36.4          | 55.04          | 68.2     | 13.16  | PK            |
| V                            | 3467      | 43.85         | 29.03          | 5.24       | 36.4          | 41.72          | 54       | 12.28  | AV            |
| H                            | 3467      | 54.97         | 29.03          | 5.24       | 36.4          | 52.84          | 68.2     | 15.36  | PK            |
| H                            | 3467      | 48.34         | 29.03          | 5.24       | 36.4          | 46.21          | 54       | 7.79   | AV            |
| V                            | 10360     | 36.04         | 39.41          | 11.45      | 34.28         | 52.62          | 68.2     | 15.58  | PK            |
| V                            | 10360     | 25.22         | 39.41          | 11.45      | 34.28         | 41.8           | 54       | 12.2   | AV            |
| H                            | 10360     | 35.03         | 39.41          | 11.45      | 34.28         | 51.61          | 68.2     | 16.59  | PK            |
| H                            | 10360     | 26.48         | 39.41          | 11.45      | 34.28         | 43.06          | 54       | 10.94  | AV            |
| <b>802.11a Mode -5200MHz</b> |           |               |                |            |               |                |          |        |               |
| V                            | 3467      | 53.44         | 29.03          | 5.24       | 36.4          | 51.31          | 68.2     | 16.89  | PK            |
| V                            | 3467      | 43.47         | 29.03          | 5.24       | 36.4          | 41.34          | 54       | 12.66  | AV            |
| H                            | 3467      | 53.05         | 29.03          | 5.24       | 36.4          | 50.92          | 68.2     | 17.28  | PK            |
| H                            | 3467      | 46.29         | 29.03          | 5.24       | 36.4          | 44.16          | 54       | 9.84   | AV            |
| V                            | 10400     | 35.88         | 39.42          | 11.47      | 34.28         | 52.49          | 68.2     | 15.71  | PK            |
| V                            | 10400     | 26.01         | 39.42          | 11.47      | 34.28         | 42.62          | 54       | 11.38  | AV            |
| H                            | 10400     | 37.24         | 39.42          | 11.47      | 34.28         | 53.85          | 68.2     | 14.35  | PK            |
| H                            | 10400     | 27.55         | 39.42          | 11.47      | 34.28         | 44.16          | 54       | 9.84   | AV            |
| <b>802.11b Mode -5240MHz</b> |           |               |                |            |               |                |          |        |               |
| V                            | 3467      | 53.77         | 29.03          | 5.24       | 36.4          | 51.64          | 68.2     | 16.56  | PK            |
| V                            | 3467      | 42.64         | 29.03          | 5.24       | 36.4          | 40.51          | 54       | 13.49  | AV            |
| H                            | 3467      | 53.07         | 29.03          | 5.24       | 36.4          | 50.94          | 68.2     | 17.26  | PK            |
| H                            | 3467      | 47.48         | 29.03          | 5.24       | 36.4          | 45.35          | 54       | 8.65   | AV            |
| V                            | 10480     | 34.95         | 39.43          | 11.47      | 34.28         | 51.57          | 68.2     | 16.63  | PK            |
| V                            | 10480     | 26.8          | 39.43          | 11.47      | 34.28         | 43.42          | 54       | 10.58  | AV            |
| H                            | 10480     | 37.15         | 39.43          | 11.47      | 34.28         | 53.77          | 68.2     | 14.43  | PK            |
| H                            | 10480     | 29.13         | 39.43          | 11.47      | 34.28         | 45.75          | 54       | 8.25   | AV            |

**REMARKS:**

1. Emission level (dBuV/m) =Raw Value (dBuV)+Correction Factor (dB/m)
2. Correction Factor (dB/m) = Antenna Factor (dB/m)+Cable Factor (dB)-Pre-amplifier Factor
3. Margin value = Limit value- Emission level.
4. -- Mean the other emission levels were very low against the limit.
5. RBW1MHz VBW3MHz Peak detector is for PK value; RBW 1MHz VBW10Hz Peak detector is for AV value.

## Radiated Band Edge Test:

| Polar (H/V)            | Frequency | Meter Reading | Antenna Factor | Cable loss | Preamp factor | Emission Level | Limits   | Margin | Detector Type |
|------------------------|-----------|---------------|----------------|------------|---------------|----------------|----------|--------|---------------|
|                        | (MHz)     | (dBuV)        | (dB)           | (dB)       | (dB)          | (dBuV/m)       | (dBuV/m) | (dB)   |               |
| <b>802.11a-5180MHz</b> |           |               |                |            |               |                |          |        |               |
| V                      | 5150      | 54.62         | 31.22          | 7.62       | 36.5          | 56.96          | 74       | 17.04  | PK            |
| V                      | 5150      | 39.17         | 31.22          | 7.62       | 36.5          | 41.51          | 54       | 12.49  | AV            |
| H                      | 5150      | 53.69         | 31.22          | 7.62       | 36.5          | 56.03          | 74       | 17.97  | PK            |
| H                      | 5150      | 41.99         | 31.22          | 7.62       | 36.5          | 44.33          | 54       | 9.67   | AV            |
| V                      | 5350      | 55.83         | 31.56          | 7.83       | 35.82         | 59.4           | 74       | 14.6   | PK            |
| V                      | 5350      | 39.27         | 31.56          | 7.83       | 35.82         | 42.84          | 54       | 11.16  | AV            |
| H                      | 5350      | 53.49         | 31.56          | 7.83       | 35.82         | 57.06          | 74       | 16.94  | PK            |
| H                      | 5350      | 41.83         | 31.56          | 7.83       | 35.82         | 45.4           | 54       | 8.6    | AV            |

| Polar (H/V)                    | Frequency | Meter Reading | Antenna Factor | Cable loss | Preamp factor | Emission Level | Limits   | Margin | Detector Type |
|--------------------------------|-----------|---------------|----------------|------------|---------------|----------------|----------|--------|---------------|
|                                | (MHz)     | (dBuV)        | (dB)           | (dB)       | (dB)          | (dBuV/m)       | (dBuV/m) | (dB)   |               |
| <b>802.11n (HT20) -5180MHz</b> |           |               |                |            |               |                |          |        |               |
| V                              | 5150      | 53.99         | 31.22          | 7.62       | 36.5          | 56.33          | 74       | 17.67  | PK            |
| V                              | 5150      | 37.93         | 31.22          | 7.62       | 36.5          | 40.27          | 54       | 13.73  | AV            |
| H                              | 5150      | 54.76         | 31.22          | 7.62       | 36.5          | 57.1           | 74       | 16.9   | PK            |
| H                              | 5150      | 42.13         | 31.22          | 7.62       | 36.5          | 44.47          | 54       | 9.53   | AV            |
| V                              | 5350      | 54.56         | 31.56          | 7.83       | 35.82         | 58.13          | 74       | 15.87  | PK            |
| V                              | 5350      | 39.3          | 31.56          | 7.83       | 35.82         | 42.87          | 54       | 11.13  | AV            |
| H                              | 5350      | 55.08         | 31.56          | 7.83       | 35.82         | 58.65          | 74       | 15.35  | PK            |
| H                              | 5350      | 42.19         | 31.56          | 7.83       | 35.82         | 45.76          | 54       | 8.24   | AV            |

| Polar (H/V)                    | Frequency | Meter Reading | Antenna Factor | Cable loss | Preamp factor | Emission Level | Limits   | Margin | Detector Type |
|--------------------------------|-----------|---------------|----------------|------------|---------------|----------------|----------|--------|---------------|
|                                | (MHz)     | (dBuV)        | (dB)           | (dB)       | (dB)          | (dBuV/m)       | (dBuV/m) | (dB)   |               |
| <b>802.11n (HT40) -5190MHz</b> |           |               |                |            |               |                |          |        |               |
| V                              | 5150      | 55.6          | 31.22          | 7.62       | 36.5          | 57.94          | 74       | 16.06  | PK            |
| V                              | 5150      | 38.34         | 31.22          | 7.62       | 36.5          | 40.68          | 54       | 13.32  | AV            |
| H                              | 5150      | 54.65         | 31.22          | 7.62       | 36.5          | 56.99          | 74       | 17.01  | PK            |
| H                              | 5150      | 44.28         | 31.22          | 7.62       | 36.5          | 46.62          | 54       | 7.38   | AV            |
| V                              | 5350      | 55.95         | 31.56          | 7.83       | 35.82         | 59.52          | 74       | 14.48  | PK            |
| V                              | 5350      | 38.94         | 31.56          | 7.83       | 35.82         | 42.51          | 54       | 11.49  | AV            |
| H                              | 5350      | 55.28         | 31.56          | 7.83       | 35.82         | 58.85          | 74       | 15.15  | PK            |
| H                              | 5350      | 41.59         | 31.56          | 7.83       | 35.82         | 45.16          | 54       | 8.84   | AV            |

| Polar (H/V)                     | Frequency | Meter Reading | Antenna Factor | Cable loss | Preamp factor | Emission Level | Limits   | Margin | Detector Type |
|---------------------------------|-----------|---------------|----------------|------------|---------------|----------------|----------|--------|---------------|
|                                 | (MHz)     | (dBuV)        | (dB)           | (dB)       | (dB)          | (dBuV/m)       | (dBuV/m) | (dB)   |               |
| <b>802.11ac (HT20) -5180MHz</b> |           |               |                |            |               |                |          |        |               |
| V                               | 5150      | 55.14         | 31.22          | 7.62       | 36.5          | 57.48          | 74       | 16.52  | PK            |
| V                               | 5150      | 38.75         | 31.22          | 7.62       | 36.5          | 41.09          | 54       | 12.91  | AV            |
| H                               | 5150      | 54.22         | 31.22          | 7.62       | 36.5          | 56.56          | 74       | 17.44  | PK            |
| H                               | 5150      | 42.11         | 31.22          | 7.62       | 36.5          | 44.45          | 54       | 9.55   | AV            |
| V                               | 5350      | 53.77         | 31.56          | 7.83       | 35.82         | 57.34          | 74       | 16.66  | PK            |
| V                               | 5350      | 40.15         | 31.56          | 7.83       | 35.82         | 43.72          | 54       | 10.28  | AV            |
| H                               | 5350      | 55.55         | 31.56          | 7.83       | 35.82         | 59.12          | 74       | 14.88  | PK            |
| H                               | 5350      | 41.21         | 31.56          | 7.83       | 35.82         | 44.78          | 54       | 9.22   | AV            |

| Polar (H/V)                     | Frequency | Meter Reading | Antenna Factor | Cable loss | Preamp factor | Emission Level | Limits   | Margin | Detector Type |
|---------------------------------|-----------|---------------|----------------|------------|---------------|----------------|----------|--------|---------------|
|                                 | (MHz)     | (dBuV)        | (dB)           | (dB)       | (dB)          | (dBuV/m)       | (dBuV/m) | (dB)   |               |
| <b>802.11ac (HT40) -5190MHz</b> |           |               |                |            |               |                |          |        |               |
| V                               | 5150      | 55.84         | 31.22          | 7.62       | 36.5          | 58.18          | 74       | 15.82  | PK            |
| V                               | 5150      | 39.47         | 31.22          | 7.62       | 36.5          | 41.81          | 54       | 12.19  | AV            |
| H                               | 5150      | 56            | 31.22          | 7.62       | 36.5          | 58.34          | 74       | 15.66  | PK            |
| H                               | 5150      | 43.21         | 31.22          | 7.62       | 36.5          | 45.55          | 54       | 8.45   | AV            |
| V                               | 5350      | 54.53         | 31.56          | 7.83       | 35.82         | 58.1           | 74       | 15.9   | PK            |
| V                               | 5350      | 40.31         | 31.56          | 7.83       | 35.82         | 43.88          | 54       | 10.12  | AV            |
| H                               | 5350      | 55.58         | 31.56          | 7.83       | 35.82         | 59.15          | 74       | 14.85  | PK            |
| H                               | 5350      | 40.39         | 31.56          | 7.83       | 35.82         | 43.96          | 54       | 10.04  | AV            |

| Polar (H/V)                     | Frequency | Meter Reading | Antenna Factor | Cable loss | Preamp factor | Emission Level | Limits   | Margin | Detector Type |
|---------------------------------|-----------|---------------|----------------|------------|---------------|----------------|----------|--------|---------------|
|                                 | (MHz)     | (dBuV)        | (dB)           | (dB)       | (dB)          | (dBuV/m)       | (dBuV/m) | (dB)   |               |
| <b>802.11ac (HT80) -5210MHz</b> |           |               |                |            |               |                |          |        |               |
| V                               | 5150      | 56.22         | 31.22          | 7.62       | 36.5          | 58.56          | 74       | 15.44  | PK            |
| V                               | 5150      | 38.11         | 31.22          | 7.62       | 36.5          | 40.45          | 54       | 13.55  | AV            |
| H                               | 5150      | 53.77         | 31.22          | 7.62       | 36.5          | 56.11          | 74       | 17.89  | PK            |
| H                               | 5150      | 42.24         | 31.22          | 7.62       | 36.5          | 44.58          | 54       | 9.42   | AV            |
| V                               | 5350      | 53.86         | 31.56          | 7.83       | 35.82         | 57.43          | 74       | 16.57  | PK            |
| V                               | 5350      | 38.62         | 31.56          | 7.83       | 35.82         | 42.19          | 54       | 11.81  | AV            |
| H                               | 5350      | 56.22         | 31.56          | 7.83       | 35.82         | 59.79          | 74       | 14.21  | PK            |
| H                               | 5350      | 40.81         | 31.56          | 7.83       | 35.82         | 44.38          | 54       | 9.62   | AV            |

### 7.3 Conduction spurious emission

#### Limit

The maximum emissions outside of the frequency bands of operation shall be attenuated in accordance with the following limits:

- (1) For transmitters operating in the 5.15-5.25 GHz band: All emissions outside of the 5.15-5.35 GHz band shall not exceed an e.i.r.p. of  $-27$  dBm/MHz.
- (2) For transmitters operating in the 5.25-5.35 GHz band: All emissions outside of the 5.15-5.35 GHz band shall not exceed an e.i.r.p. of  $-27$  dBm/MHz.
- (3) For transmitters operating in the 5.47-5.725 GHz band: All emissions outside of the 5.47-5.725 GHz band shall not exceed an e.i.r.p. of  $-27$  dBm/MHz.
- (4) For transmitters operating in the 5.725-5.85 GHz band: All emissions shall be limited to a level of  $-27$  dBm/MHz at 75 MHz or more above or below the band edge increasing linearly to 10 dBm/MHz at 25 MHz above or below the band edge, and from 25 MHz above or below the band edge increasing linearly to a level of 15.6 dBm/MHz at 5 MHz above or below the band edge, and from 5 MHz above or below the band edge increasing linearly to a level of 27 dBm/MHz at the band edge.

#### Test Procedure

Use the following spectrum analyzer settings:

Span = wide enough to capture the peak level of the in-band emission and all spurious emissions (e.g., harmonics) from the lowest frequency generated in the EUT up through the 10th harmonic. Typically, several plots are required to cover this entire span.

RBW = 1 MHz for  $f \geq 1$  GHz, 100 kHz for  $f < 1$  GHz

VBW  $\geq$  RBW

Sweep = auto

Detector function = peak

Trace = max hold

Allow the trace to stabilize

#### Test Configuration



#### TEST RESULTS

See APPENDIX V.



## 7.4 Maximum Conducted Average Output Power

### Limit

#### **For the band 5.15-5.25 GHz.**

(i) For an outdoor access point operating in the band 5.15-5.25 GHz, the maximum conducted output power over the frequency band of operation shall not exceed 1 W provided the maximum antenna gain does not exceed 6 dBi.

(ii) For an indoor access point operating in the band 5.15-5.25 GHz, the maximum conducted output power over the frequency band of operation shall not exceed 1 W provided the maximum antenna gain does not exceed 6 dBi.

(iii) For fixed point-to-point access points operating in the band 5.15-5.25 GHz, the maximum conducted output power over the frequency band of operation shall not exceed 1 W.

(iv) For client devices in the 5.15-5.25 GHz band, the maximum conducted output power over the frequency band of operation shall not exceed 250 mW provided the maximum antenna gain does not exceed 6 dBi.

**For the 5.25-5.35 GHz and 5.47-5.725 GHz bands**, the maximum conducted output power over the frequency bands of operation shall not exceed the lesser of 250 mW or  $11 \text{ dBm} + 10 \log B$ , where B is the 26 dB emission bandwidth in megahertz.

**For the band 5.725-5.85 GHz**, the maximum conducted output power over the frequency band of operation shall not exceed 1 W

### Test Procedure

Remove the antenna from the EUT and then connect a low loss RF cable from the antenna port to the power sensor.

### Test Configuration

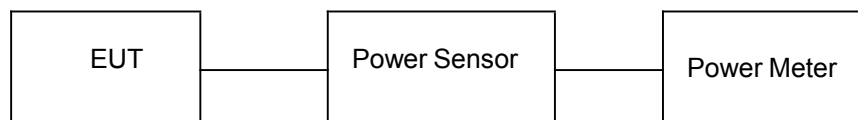

### Test Results

See APPENDIX II.

## 7.5 Power Spectral Density

### Limit

(1) For the band 5.15 - 5.25 GHz.

(i) For an outdoor access point operating in the band 5.15 - 5.25 GHz, the maximum power spectral density shall not exceed 17 dBm in any 1 MHz band. <sup>note1</sup>

(ii) For an indoor access point operating in the band 5.15 - 5.25 GHz, the maximum power spectral density shall not exceed 17 dBm in any 1 MHz band. <sup>note1</sup>

(iii) For fixed point-to-point access points operating in the band 5.15 - 5.25 GHz, transmitters that employ a directional antenna gain greater than 23 dBi, a 1 dB reduction in maximum power spectral density is required for each 1 dB of antenna gain in excess of 23 dBi.

(iv) For mobile and portable client devices in the 5.15 - 5.25 GHz band, the maximum power spectral density shall not exceed 11 dBm in any 1 MHz band. <sup>note1</sup>

(2) For the 5.25 - 5.35 GHz and 5.47 - 5.725 GHz bands, the peak power spectral density shall not exceed 11 dBm in any 1 MHz band. <sup>note1</sup>

(3) For the band 5.725 - 5.85 GHz, the maximum power spectral density shall not exceed 30 dBm in any 500 kHz band. <sup>note1, note2</sup>

Note1: If transmitting antennas of directional gain greater than 6 dBi are used, the peak power spectral density shall be reduced by the amount in dB that the directional gain of the antenna exceeds 6 dBi.

Note2: Fixed point - to-point U-NII devices operating in this band may employ transmitting antennas with directional gain greater than 6 dBi without any corresponding reduction in transmitter conducted power. Fixed, point-to-point operations exclude the use of point-to-multipoint systems, omnidirectional applications, and multiple collocated transmitters transmitting the same information.

### Test Procedure

1. Use this procedure when the maximum peak conducted output power in the fundamental emission is used to demonstrate compliance.
2. Set the RBW = 1MHz for U-NII 1, U-NII 2A, U-NII C band and 510KHz for U-NII 3 band.
3. Set the VBW  $\geq 3 \times$  RBW.
4. Set the span to encompass the entire EBW.
5. Detector = peak.
6. Sweep time = auto couple.
7. Trace mode = max hold.
8. Allow trace to fully stabilize.
9. Use the peak marker function to determine the maximum power level.

### Test Configuration



**Test Results**

See APPENDIX VII.

## 7.6 Emission Bandwidth (26dBm Bandwidth)

### Limit

N/A

### Test Procedure

1. Set resolution bandwidth (RBW) = approximately 1 % of the EBW.
2. Set the video bandwidth (VBW) > RBW.
3. Detector = Peak.
4. Trace mode = Max hold.
5. Measure the maximum width of the emission that is 26 dB down from the peak of the emission. Compare this with the RBW setting of the analyzer. Readjust RBW and repeat measurement as needed until the RBW / EBW ratio is approximately 1 %.

### Test Configuration



### Test Results

See APPENDIX IV.

## 7.7 Minimum Emission Bandwidth (6dBm Bandwidth)

### Limit

Within the 5.725-5.85 GHz band, the minimum 6 dB bandwidth of U-NII devices shall be at least 500 kHz.

### Test Procedure

1. Set resolution bandwidth (RBW) = 100 kHz
2. Set the video bandwidth 3 x RBW.
3. Detector = Peak.
4. Trace mode = Max hold.
5. Measure the maximum width of the emission that is constrained by the frequencies associated with the two outermost amplitude points (upper and lower frequencies) that are attenuated by 6 dB relative to the maximum level measured in the fundamental emission.

### Test Configuration



### Test Results

See APPENDIX III.

## 7.8 Frequency Stability

### LIMIT

Manufacturers of U-NII devices are responsible for ensuring frequency stability such that an emission is maintained within the band of operation under all conditions of normal operation as specified in the users manual.

### TEST CONFIGURATION

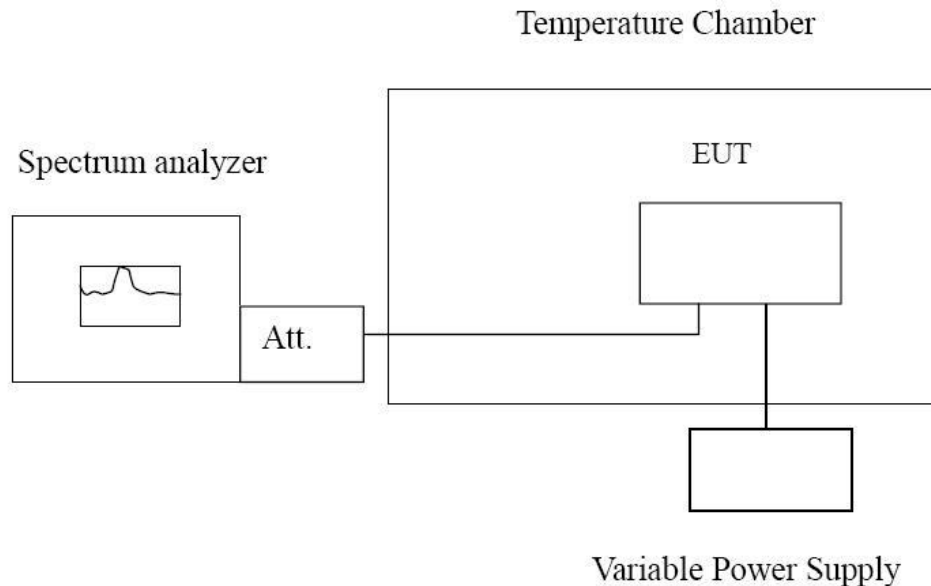

### TEST PROCEDURE

#### **Frequency Stability under Temperature Variations:**

The equipment under test was connected to an external AC or DC power supply and input rated voltage. RF output was connected to a frequency counter or spectrum analyzer via feed through attenuators. The EUT was placed inside the temperature chamber. Set the spectrum analyzer RBW low enough to obtain the desired frequency resolution and measure EUT 20°C operating frequency as reference frequency. Turn EUT off and set the chamber temperature to -30°C. After the temperature stabilized for approximately 30 minutes recorded the frequency. Repeat step measure with 10°C increased per stage until the highest temperature of +50°C reached.

#### **Frequency Stability under Voltage Variations:**

Set chamber temperature to 20°C. Use a variable AC power supply / DC power source to power the EUT and set the voltage to rated voltage. Set the spectrum analyzer RBW low enough to obtain the desired frequency resolution and recorded the frequency.

Reduce the input voltage to specify extreme voltage variation ( $\pm 15\%$ ) and endpoint, record the maximum frequency change.

### TEST RESULTS

See APPENDIX I.

## 7.9 Duty Cycle Information

### Test Results

See APPENDIX VI.

## 7.10 Antenna Requirement

### Standard Applicable

#### **For intentional device, according to FCC 47 CFR Section 15.203:**

An intentional radiator shall be designed to ensure that no antenna other than that furnished by the responsible party shall be used with the device. The use of a permanently attached antenna or of an antenna that uses a unique coupling to the intentional radiator, the manufacturer may design the unit so that a broken antenna can be replaced by the user, but the use of a standard antenna jack or electrical connector is prohibited.

#### **FCC CFR Title 47 Part 15 Subpart C Section 15.407::**

An intentional radiator shall be designed to ensure that no antenna other than that furnished by the responsible party shall be used with the device. The use of a permanently attached antenna or of an antenna that uses a unique coupling to the intentional radiator shall be considered sufficient to comply with the provisions of this section. The manufacturer may design the unit so that a broken antenna can be replaced by the user, but the use of a standard antenna jack or electrical connector is prohibited. This requirement does not apply to carrier current devices or to devices operated under the provisions of §15.211, §15.213,

§15.217, §15.219, or §15.221. Further, this requirement does not apply to intentional radiators that must be professionally installed, such as perimeter protection systems and some field disturbance sensors, or to other intentional radiators which, in accordance with §15.31(d), must be measured at the installation site. However, the installer shall be responsible for ensuring that the proper antenna is employed so that the limits in this part are not exceeded.

### Test Result:

The directional gains of antenna used for transmitting is 2.71dBi, and the antenna is an internal antenna connect to FPC Antenna and no consideration of replacement. Please see EUT photo for details.

Results: Compliance.



## 8 Test Setup Photos of the EUT

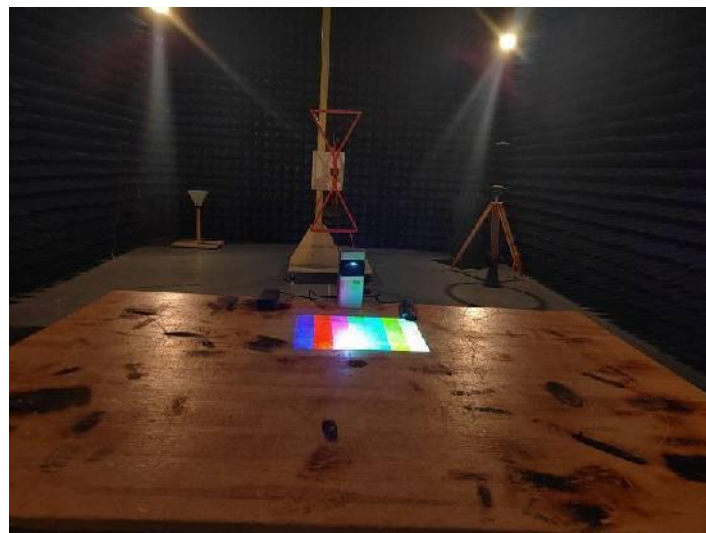

## 9 External and Internal Photos of the EUT

See related photo report.

### APPENDIX I. Frequency Stability

**Test Result**

| Condition | Mode             | Ch. | Antenna | Modulation Signal | Center Frequency (MHz) | Calculated Value of Center Frequency(MHz) | Result (ppm) | Limit (ppm)            | State |
|-----------|------------------|-----|---------|-------------------|------------------------|---|--------------|------------------------|-------|
| NT/NV     | IEEE 802.11a     | 36  | 2.71    | False             | 5180.0                 | 5180.225074                               | 43.45        | Within authorized band | PASS  |
|           |                  | 40  |         | False             | 5200.0                 | 5200.221524                               | 42.6         |                        | PASS  |
|           |                  | 44  |         | False             | 5220.0                 | 5219.755325                               | -46.87       |                        | PASS  |
|           | IEEE 802.11n_20  | 36  |         | False             | 5180.0                 | 5180.240087                               | 46.35        |                        | PASS  |
|           |                  | 40  |         | False             | 5200.0                 | 5200.242250                               | 46.59        |                        | PASS  |
|           |                  | 44  |         | False             | 5220.0                 | 5220.232662                               | 44.57        |                        | PASS  |
|           | IEEE 802.11n_40  | 38  |         | False             | 5190.0                 | 5189.755875                               | -47.04       |                        | PASS  |
|           |                  | 46  |         | False             | 5230.0                 | 5230.215524                               | 41.21        |                        | PASS  |
|           | IEEE 802.11ac_20 | 36  |         | False             | 5180.0                 | 5180.246525                               | 47.59        |                        | PASS  |
|           |                  | 40  |         | False             | 5200.0                 | 5200.248712                               | 47.83        |                        | PASS  |
|           |                  | 44  |         | False             | 5220.0                 | 5220.236350                               | 45.28        |                        | PASS  |
|           | IEEE 802.11ac_40 | 38  |         | False             | 5190.0                 | 5190.249950                               | 48.16        |                        | PASS  |
|           |                  | 46  |         | False             | 5230.0                 | 5230.237475                               | 45.41        |                        | PASS  |
|           | IEEE 802.11ac_80 | 42  |         | False             | 5210.0                 | 5210.249950                               | 47.98        |                        | PASS  |

**Test Graphs**

**NT/NV**

**IEEE 802.11a**

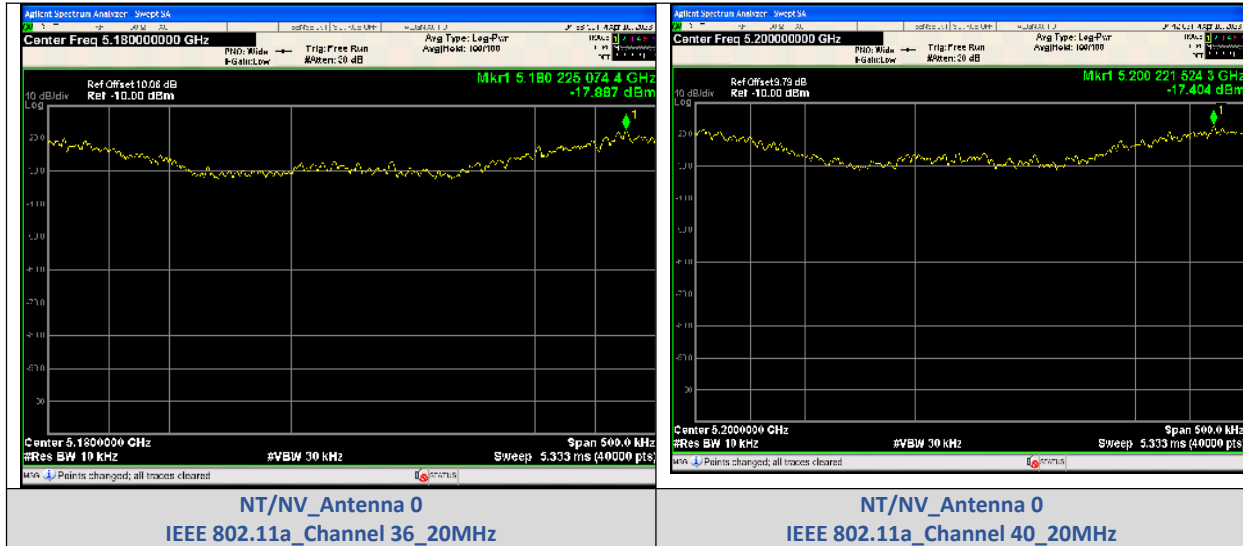

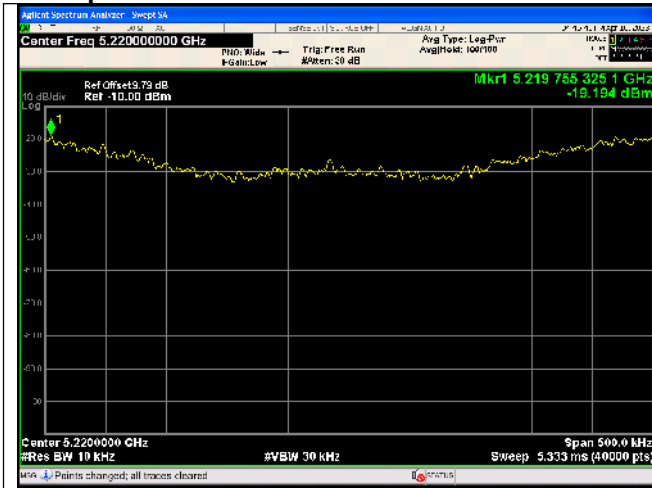

Void

NT/NV\_Antenna 0  
IEEE 802.11a\_Channel 44\_20MHz

IEEE 802.11n\_20

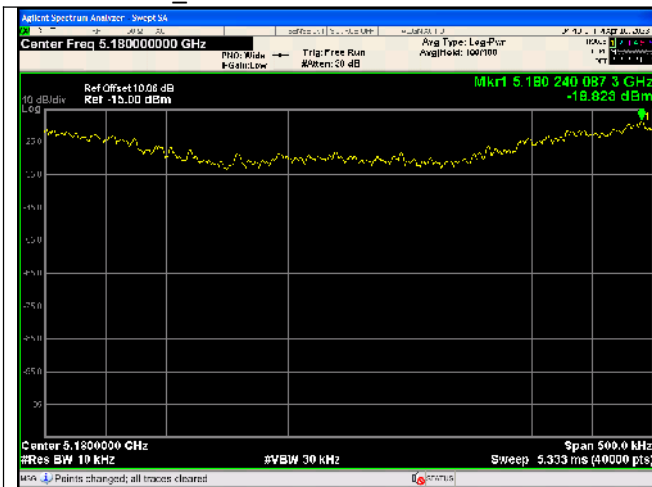

NT/NV\_Antenna 0  
IEEE 802.11n\_Channel 36\_20MHz

NT/NV\_Antenna 0  
IEEE 802.11n\_Channel 40\_20MHz



Void

NT/NV\_Antenna 0  
IEEE 802.11n\_Channel 44\_20MHz

IEEE 802.11n\_40

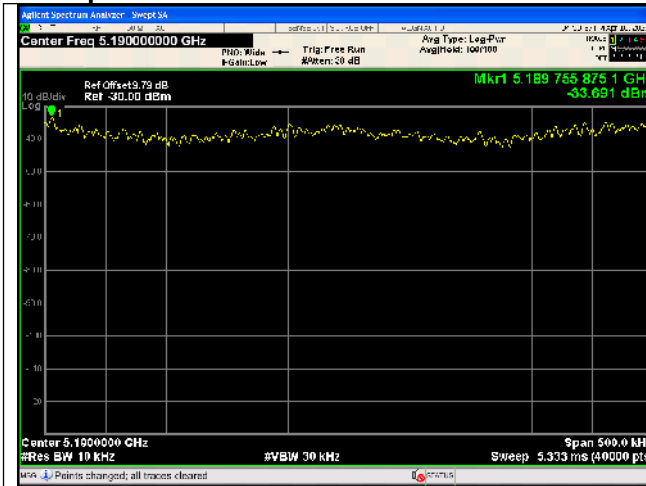

NT/NV\_Antenna 0  
IEEE 802.11n\_Channel 38\_40MHz

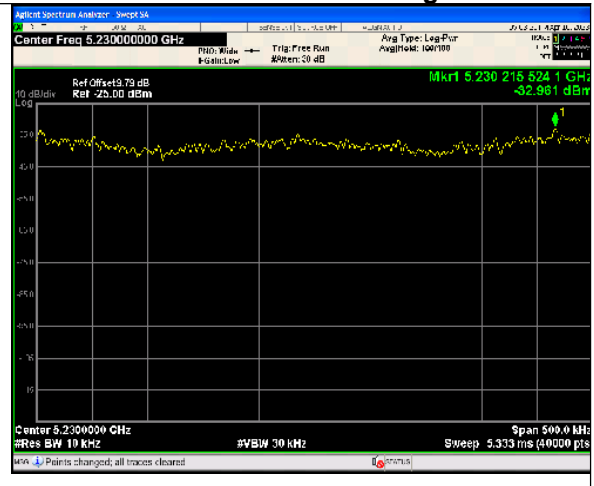

NT/NV\_Antenna 0  
IEEE 802.11n\_Channel 46\_40MHz

IEEE 802.11ac\_20

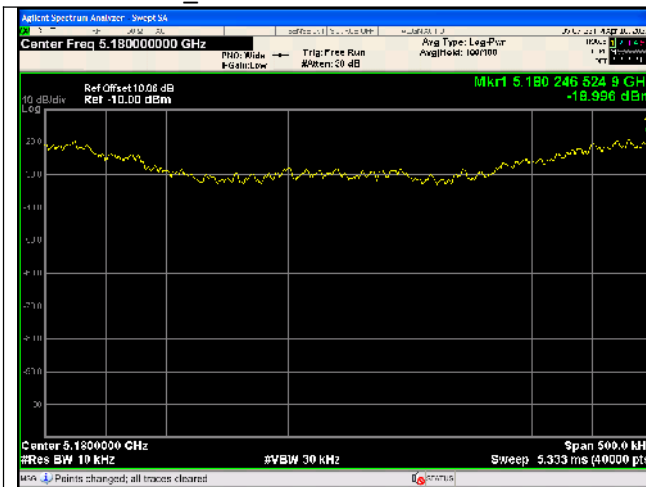

NT/NV\_Antenna 0  
IEEE 802.11ac\_Channel 36\_20MHz



NT/NV\_Antenna 0  
IEEE 802.11ac\_Channel 40\_20MHz



NT/NV\_Antenna 0  
IEEE 802.11ac\_Channel 44\_20MHz

Void

IEEE 802.11ac\_40



NT/NV\_Antenna 0  
IEEE 802.11ac\_Channel 38\_40MHz

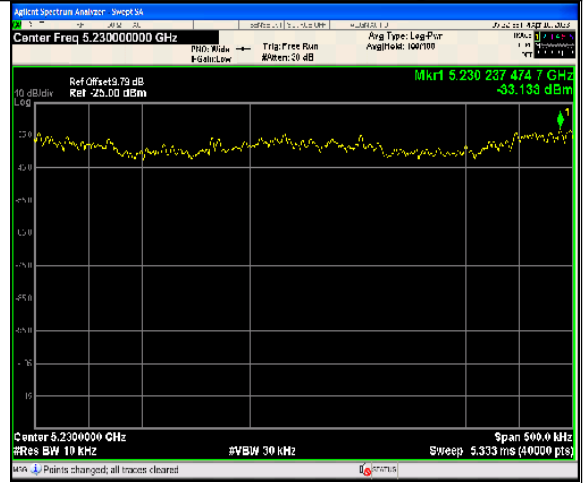

NT/NV\_Antenna 0  
IEEE 802.11ac\_Channel 46\_40MHz

IEEE 802.11ac\_80

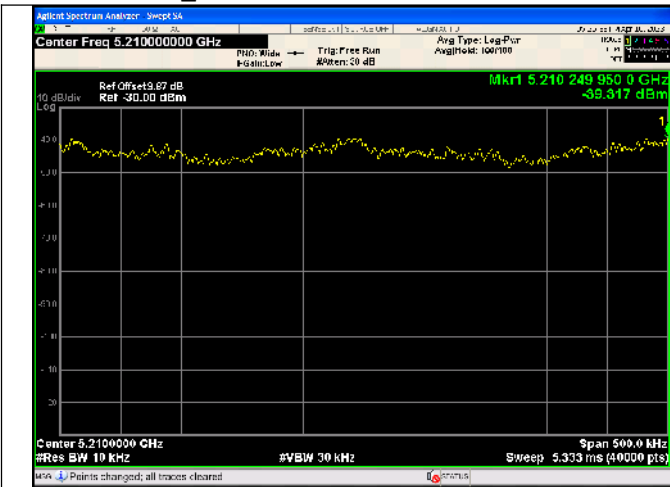

NT/NV\_Antenna 0  
IEEE 802.11ac\_Channel 42\_80MHz

Void

## APPENDIX II. Conducted Peak Output Power

Conducted AVG output power

| Mode             | Channel | Ant. 0 (dBm) | Limit (dBm) | Result |
|------------------|---------|--------------|-------------|--------|
| IEEE 802.11a     | 36      | 12.30        | 24          | PASS   |
|                  | 40      | 11.20        | 24          | PASS   |
|                  | 44      | 14.33        | 24          | PASS   |
| IEEE 802.11n_20  | 36      | 15.22        | 24          | PASS   |
|                  | 40      | 14.52        | 24          | PASS   |
|                  | 44      | 15.21        | 24          | PASS   |
| IEEE 802.11n_40  | 38      | 13.69        | 24          | PASS   |
|                  | 46      | 14.52        | 24          | PASS   |
| IEEE 802.11ac_20 | 36      | 13.58        | 24          | PASS   |
|                  | 40      | 13.22        | 24          | PASS   |
|                  | 44      | 14.47        | 24          | PASS   |
| IEEE 802.11ac_40 | 38      | 13.69        | 24          | PASS   |
|                  | 46      | 14.85        | 24          | PASS   |
| IEEE 802.11ac_80 | 42      | 13.89        | 24          | PASS   |

## APPENDIX III. 6dB Bandwidth

Test Result

| Mode             | Channel | Ant. | Center Frequency (MHz) | 6 dB Bandwidth (MHz) | Limit (MHz) | Result |
|------------------|---------|------|------------------------|----------------------|-------------|--------|
| IEEE 802.11a     | 36      | 2.71 | 5180                   | 15.51                | 0.5         | PASS   |
|                  | 40      |      | 5200                   | 15.34                |             | PASS   |
|                  | 44      |      | 5220                   | 15.11                |             | PASS   |
| IEEE 802.11n_20  | 36      |      | 5180                   | 15.11                |             | PASS   |
|                  | 40      |      | 5200                   | 15.12                |             | PASS   |
|                  | 44      |      | 5220                   | 15.37                |             | PASS   |
| IEEE 802.11n_40  | 38      |      | 5190                   | 35.67                |             | PASS   |
|                  | 46      |      | 5230                   | 35.09                |             | PASS   |
| IEEE 802.11ac_20 | 36      |      | 5180                   | 15.67                |             | PASS   |
|                  | 40      |      | 5200                   | 16.61                |             | PASS   |
|                  | 44      |      | 5220                   | 16.05                |             | PASS   |
| IEEE 802.11ac_40 | 38      |      | 5190                   | 35.11                |             | PASS   |
|                  | 46      |      | 5230                   | 35.10                |             | PASS   |
| IEEE 802.11ac_80 | 42      |      | 5210                   | 75.11                |             | PASS   |

Test Graphs

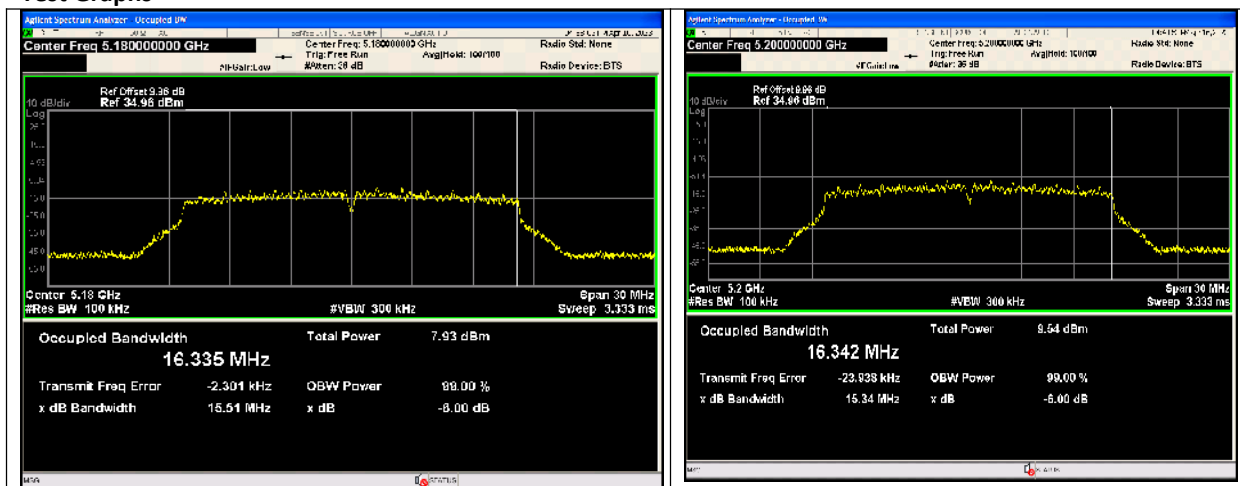

IEEE 802.11a\_Channel 36\_20MHz\_Antenna 0

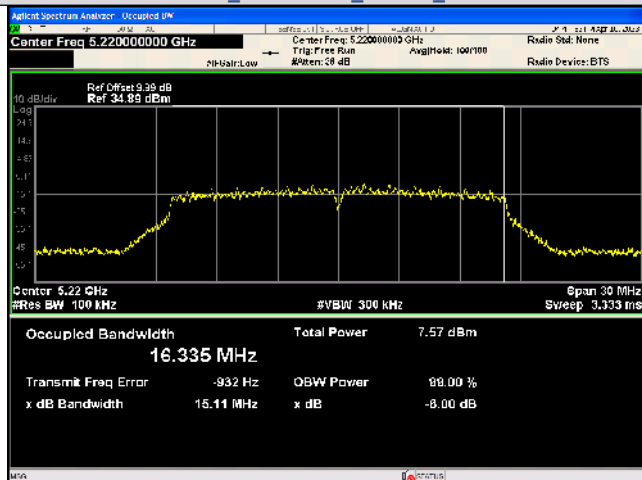

IEEE 802.11a\_Channel 40\_20MHz\_Antenna 0

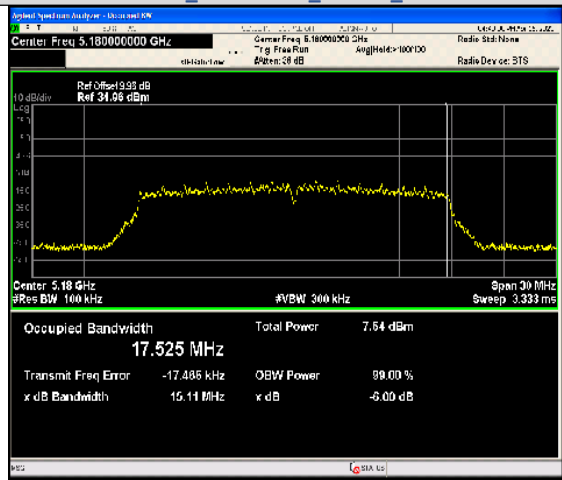

IEEE 802.11a\_Channel 44\_20MHz\_Antenna 0

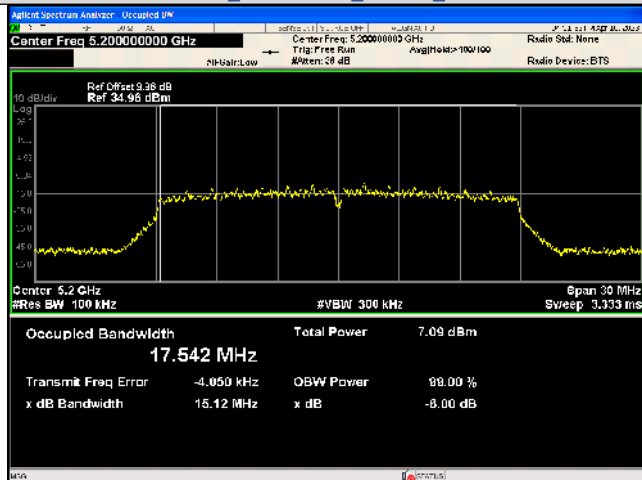

IEEE 802.11n\_Channel 36\_20MHz\_Antenna 0

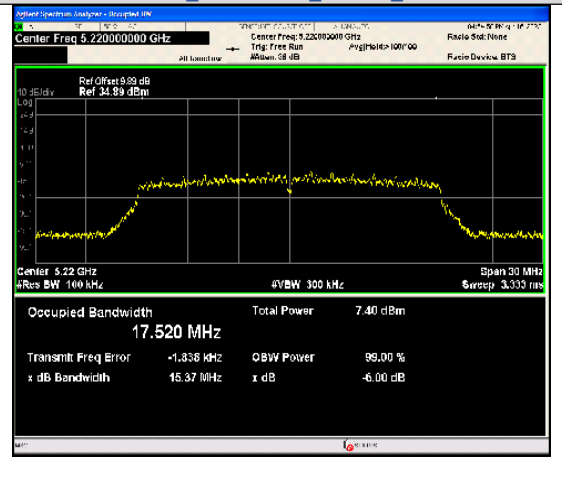

IEEE 802.11n\_Channel 40\_20MHz\_Antenna 0

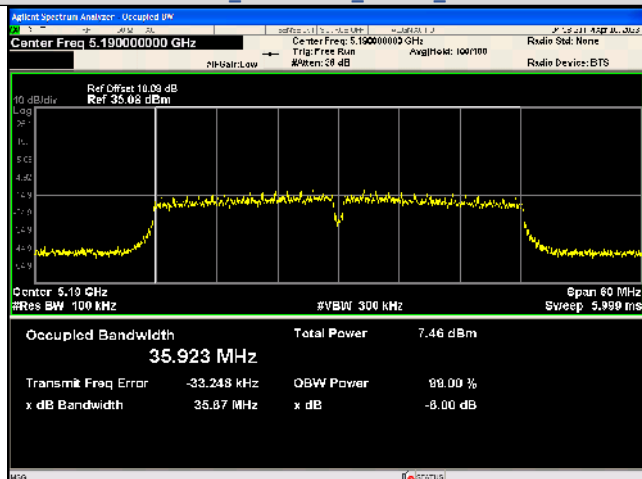

IEEE 802.11n\_Channel 44\_20MHz\_Antenna 0

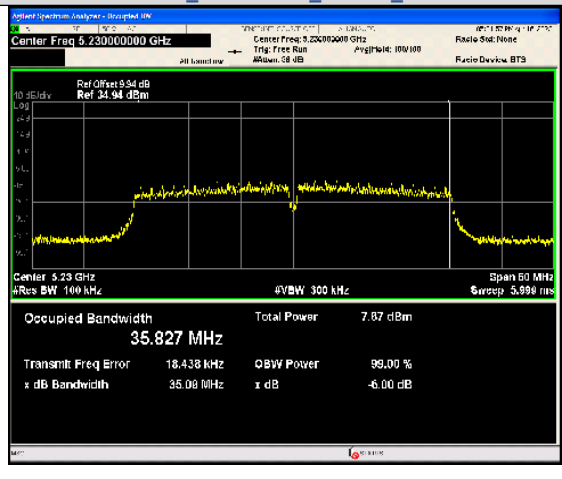

IEEE 802.11n\_Channel 38\_40MHz\_Antenna 0

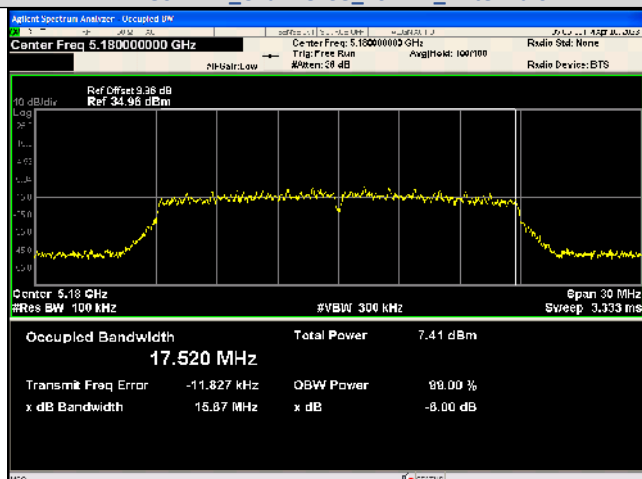

IEEE 802.11n\_Channel 46\_40MHz\_Antenna 0

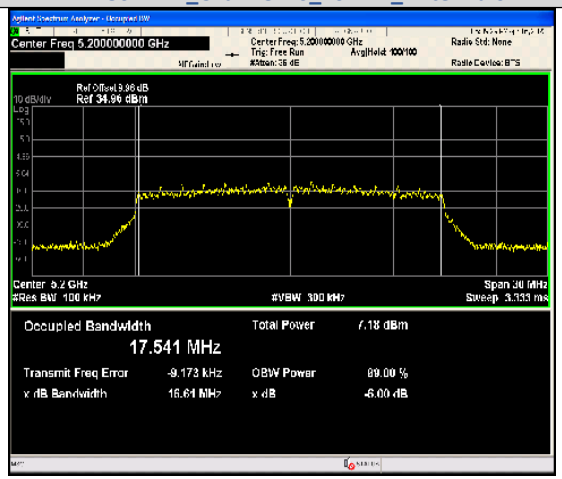

IEEE 802.11ac\_Channel 36\_20MHz\_Antenna 0

IEEE 802.11ac\_Channel 40\_20MHz\_Antenna 0

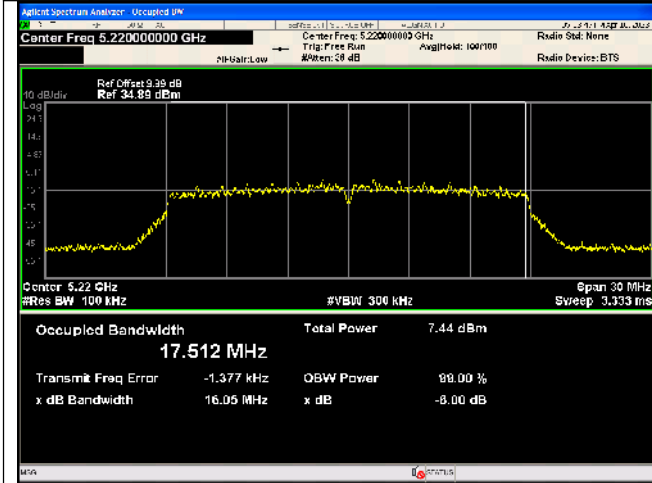

IEEE 802.11ac\_Channel 44\_20MHz\_Antenna 0

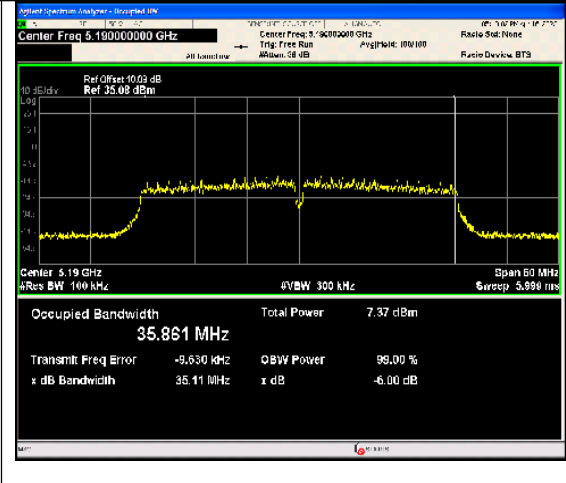

IEEE 802.11ac\_Channel 38\_40MHz\_Antenna 0

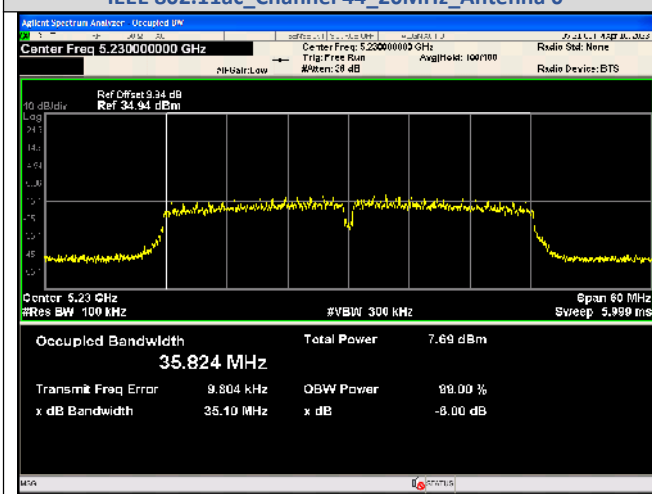

IEEE 802.11ac\_Channel 46\_40MHz\_Antenna 0

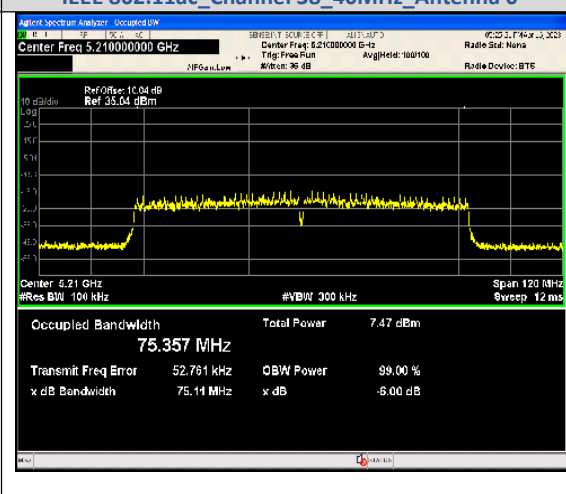

IEEE 802.11ac\_Channel 42\_80MHz\_Antenna 0



# APPENDIX IV. 26dB Bandwidth

## Test Result

| Mode             | Channel | Ant. | Center Frequency (MHz) | 26 dB Bandwidth (MHz) | RBW/EBW |
|------------------|---------|------|------------------------|-----------------------|---------|
| IEEE 802.11a     | 36      | 2.71 | 5180                   | 19.34                 | 1.13    |
|                  | 40      |      | 5200                   | 19.59                 | 1.1     |
|                  | 44      |      | 5220                   | 19.49                 | 1.11    |
| IEEE 802.11n_20  | 36      |      | 5180                   | 19.95                 | 1.1     |
|                  | 40      |      | 5200                   | 19.81                 | 1.12    |
|                  | 44      |      | 5220                   | 19.89                 | 1.11    |
| IEEE 802.11n_40  | 38      |      | 5190                   | 39.87                 | 1.07    |
|                  | 46      |      | 5230                   | 39.66                 | 1.07    |
| IEEE 802.11ac_20 | 36      |      | 5180                   | 19.71                 | 1.11    |
|                  | 40      |      | 5200                   | 19.67                 | 1.13    |
|                  | 44      |      | 5220                   | 20.10                 | 1.1     |
| IEEE 802.11ac_40 | 38      |      | 5190                   | 40.13                 | 1.07    |
|                  | 46      | 5230 | 40.54                  | 1.05                  |         |
| IEEE 802.11ac_80 | 42      | 5210 | 81.20                  | 1.03                  |         |

## Test Graphs

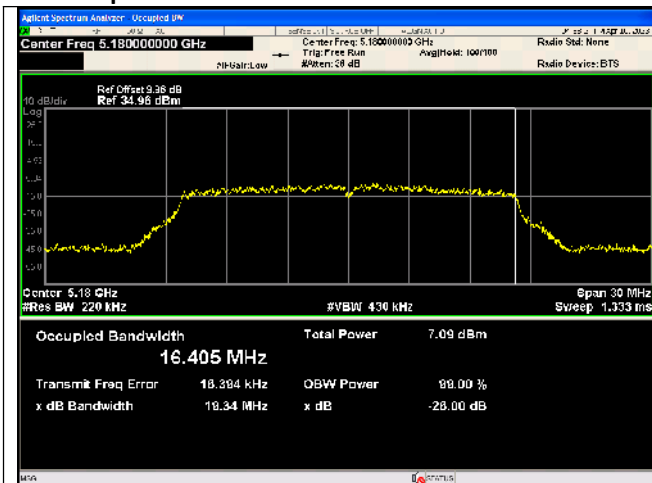

IEEE 802.11a\_Channel 36\_20MHz\_Antenna 0

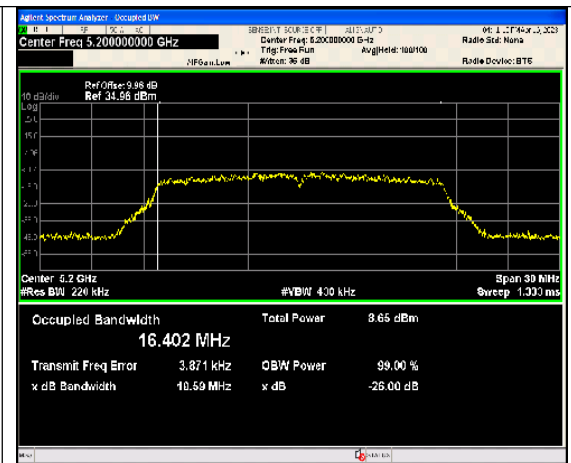

IEEE 802.11a\_Channel 40\_20MHz\_Antenna 0

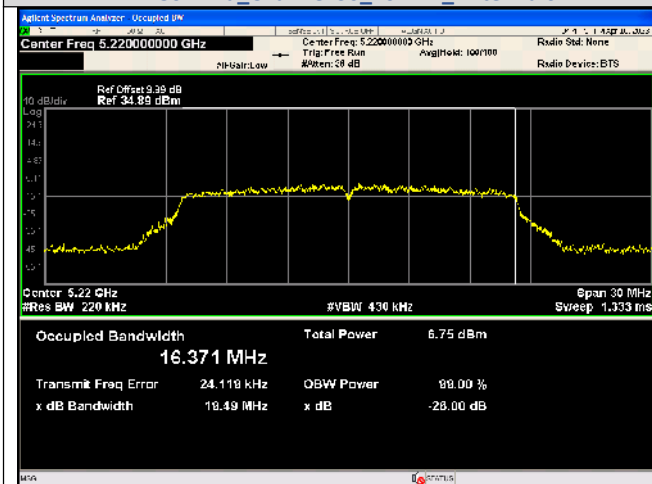

IEEE 802.11a\_Channel 44\_20MHz\_Antenna 0

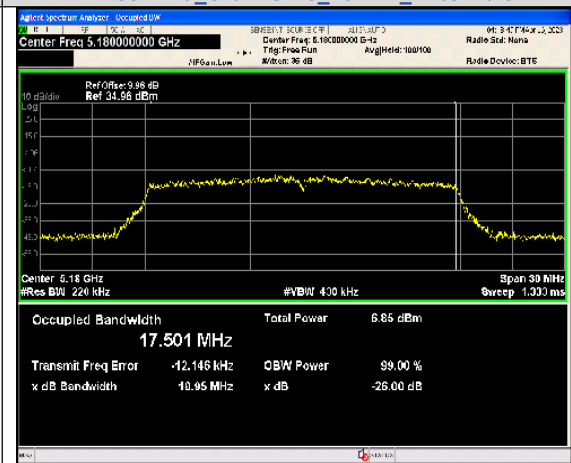

IEEE 802.11n\_Channel 36\_20MHz\_Antenna 0

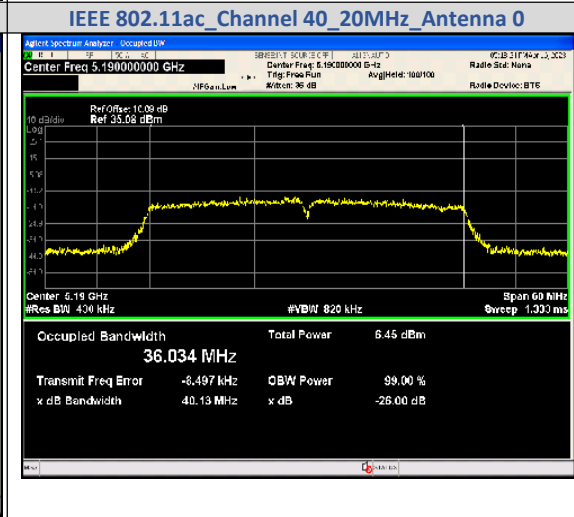
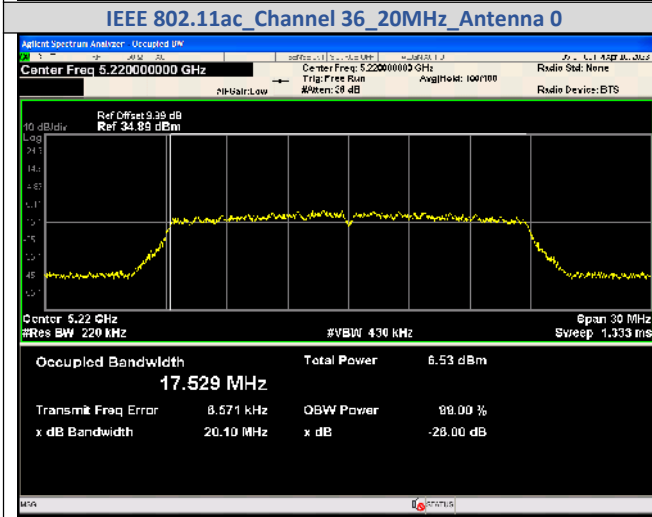
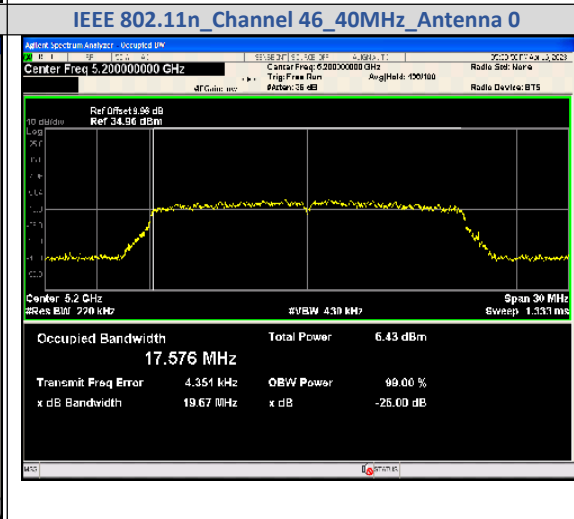
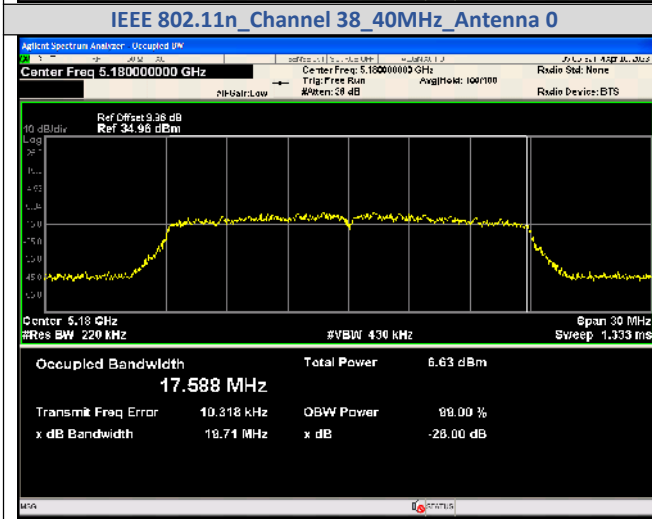
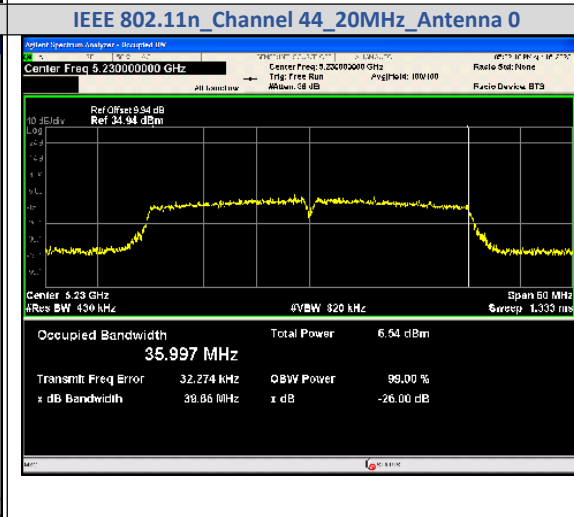
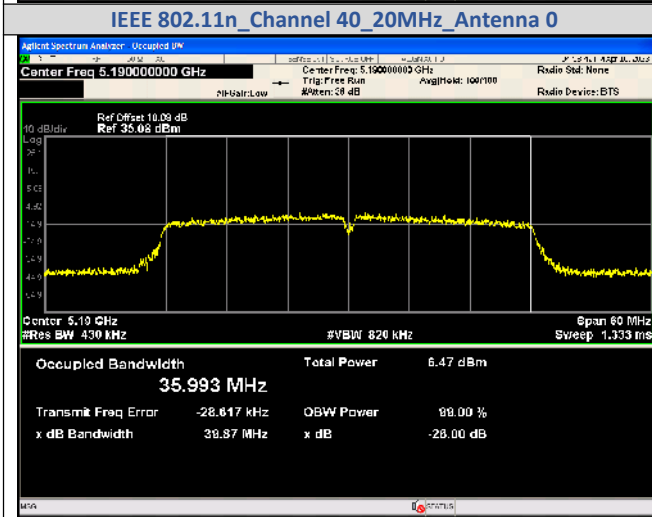
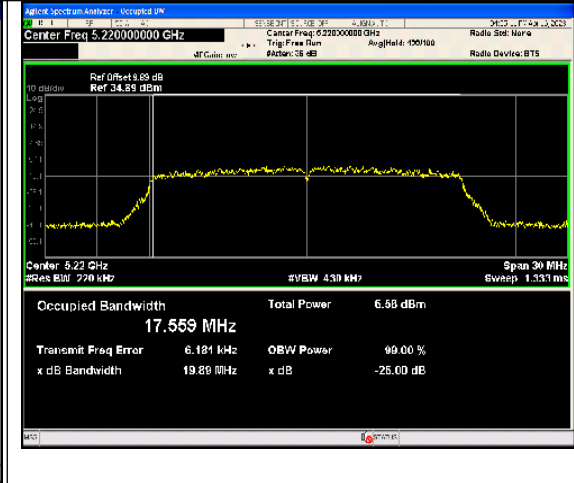
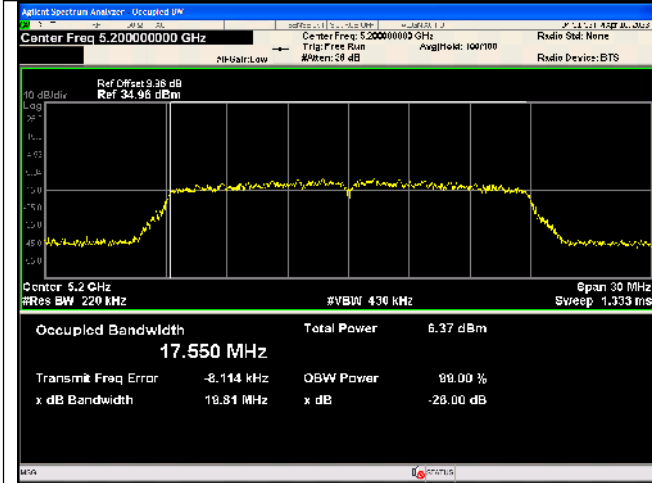

IEEE 802.11ac\_Channel 44\_20MHz\_Antenna 0

IEEE 802.11ac\_Channel 38\_40MHz\_Antenna 0

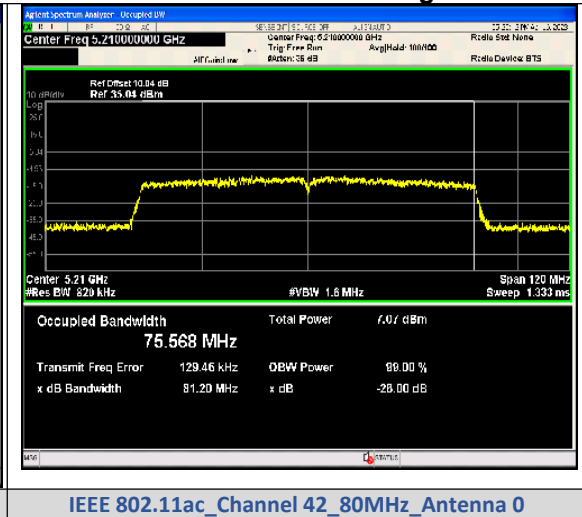
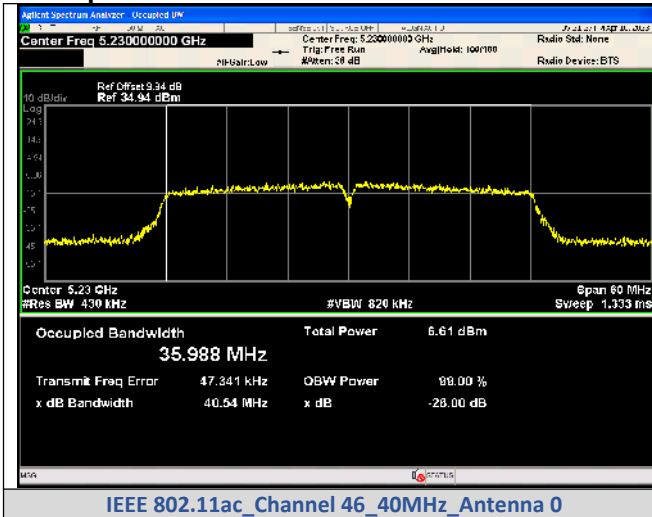

## APPENDIX V. Conducted Out Of Band Emission

### Test Result

| Mode             | Channel | Ant.    | OOB Emission Frequency (MHz) | OOB Emission Level (dBm) | Limit (dBm) | Over Limit (dB) | Result |
|------------------|---------|---------|------------------------------|--------------------------|-------------|-----------------|--------|
| IEEE 802.11a     | 36      | 0       | 2483.50                      | -43.596                  | -28.74      | -15             | PASS   |
|                  |         |         | 5177.69                      | -5.878                   | -28.74      | 22.862          | PASS   |
|                  | 40      |         | 2483.50                      | -42.947                  | -27.19      | -16             | PASS   |
|                  |         |         | 5198.92                      | -3.175                   | -27.19      | 24.015          | PASS   |
|                  | 44      |         | 2483.50                      | -44.005                  | -29.11      | -15             | PASS   |
|                  |         |         | 5218.90                      | -4.955                   | -29.11      | 24.155          | PASS   |
| IEEE 802.11n_20  | 36      |         | 2483.50                      | -43.471                  | -28.83      | -15             | PASS   |
|                  |         |         | 5181.44                      | -4.675                   | -28.83      | 24.155          | PASS   |
|                  | 40      |         | 2483.50                      | -43.647                  | -29.13      | -15             | PASS   |
|                  |         |         | 5202.66                      | -5.364                   | -29.13      | 23.766          | PASS   |
|                  | 44      |         | 2483.50                      | -44.199                  | -28.87      | -15             | PASS   |
|                  |         |         | 5216.40                      | -6.624                   | -28.87      | 22.246          | PASS   |
| IEEE 802.11n_40  | 38      | 2483.50 | -43.757                      | -31.92                   | -12         | PASS            |        |
|                  |         | 5192.68 | -7.744                       | -31.92                   | 24.177      | PASS            |        |
|                  | 46      | 2483.50 | -42.969                      | -31.72                   | -11         | PASS            |        |
|                  |         | 5232.63 | -7.494                       | -31.72                   | 24.226      | PASS            |        |
| IEEE 802.11ac_20 | 36      | 2483.50 | -44.238                      | -28.69                   | -16         | PASS            |        |
|                  |         | 5181.44 | -5.334                       | -28.69                   | 23.356      | PASS            |        |
|                  | 40      | 2483.50 | -43.096                      | -29.06                   | -14         | PASS            |        |
|                  |         | 5201.42 | -5.139                       | -29.06                   | 23.921      | PASS            |        |
|                  | 44      | 2483.50 | -44.556                      | -29.05                   | -16         | PASS            |        |
|                  |         | 5222.64 | -7.047                       | -29.05                   | 22.003      | PASS            |        |
| IEEE 802.11ac_40 | 38      | 2483.50 | -43.752                      | -31.94                   | -12         | PASS            |        |
|                  |         | 5193.93 | -8.431                       | -31.94                   | 23.509      | PASS            |        |
|                  | 46      | 2483.50 | -44.067                      | -31.58                   | -12         | PASS            |        |
|                  |         | 5227.64 | -8.156                       | -31.58                   | 23.424      | PASS            |        |
| IEEE 802.11ac_80 | 42      | 2483.50 | -42.428                      | -34.5                    | -8          | PASS            |        |
|                  |         | 5215.15 | -10.738                      | -34.5                    | 23.762      | PASS            |        |

### Test Graphs

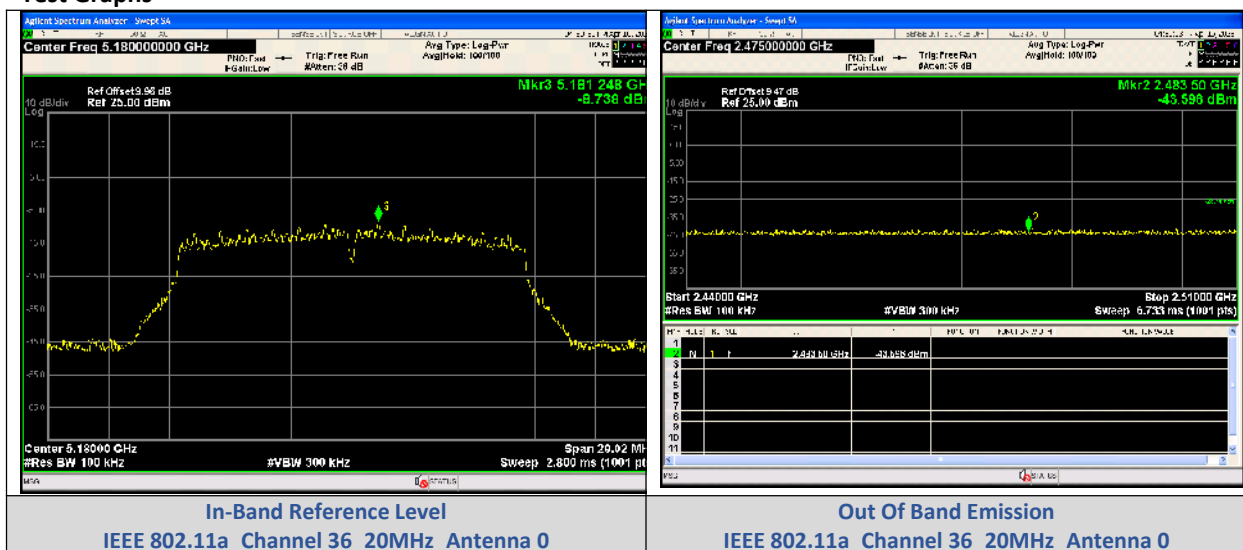

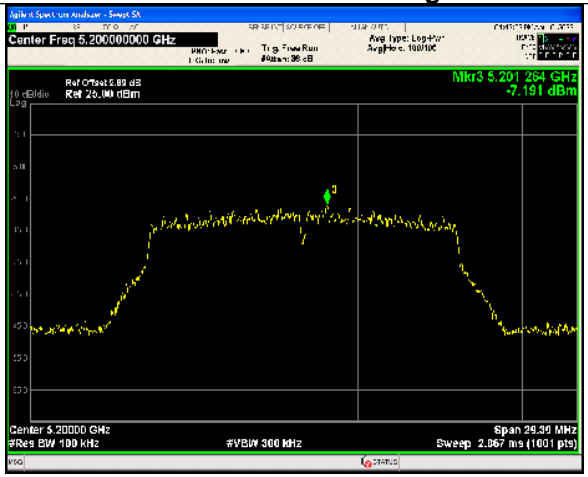
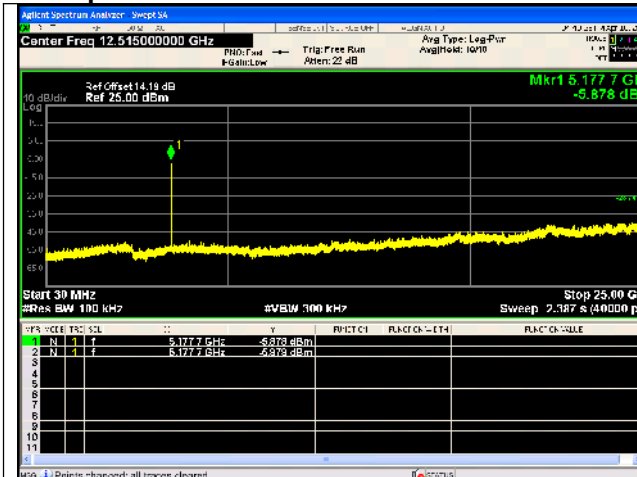

Spurious Emission  
IEEE 802.11a\_Channel 36\_20MHz\_Antenna 0

In-Band Reference Level  
IEEE 802.11a\_Channel 40\_20MHz\_Antenna 0

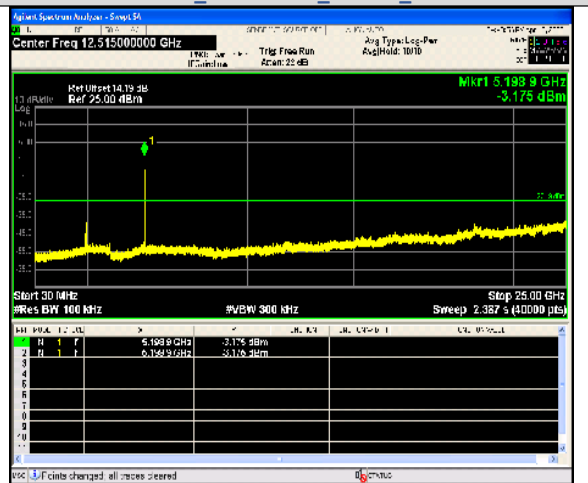
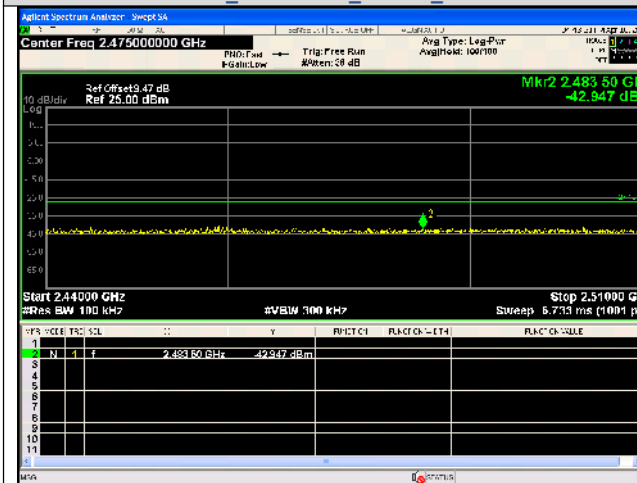

Out Of Band Emission  
IEEE 802.11a\_Channel 40\_20MHz\_Antenna 0

Spurious Emission  
IEEE 802.11a\_Channel 40\_20MHz\_Antenna 0

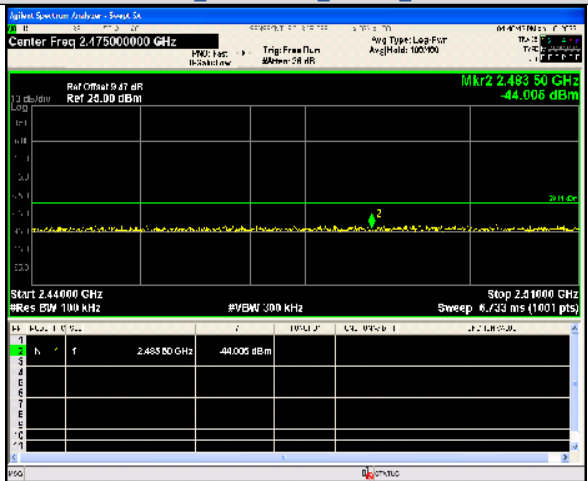
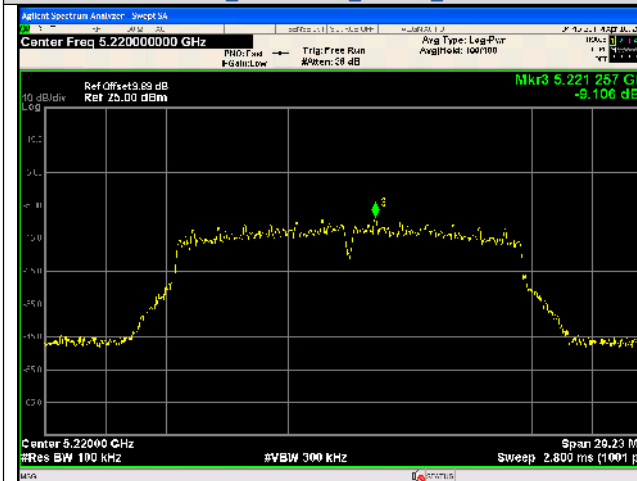

In-Band Reference Level  
IEEE 802.11a\_Channel 44\_20MHz\_Antenna 0

Out Of Band Emission  
IEEE 802.11a\_Channel 44\_20MHz\_Antenna 0

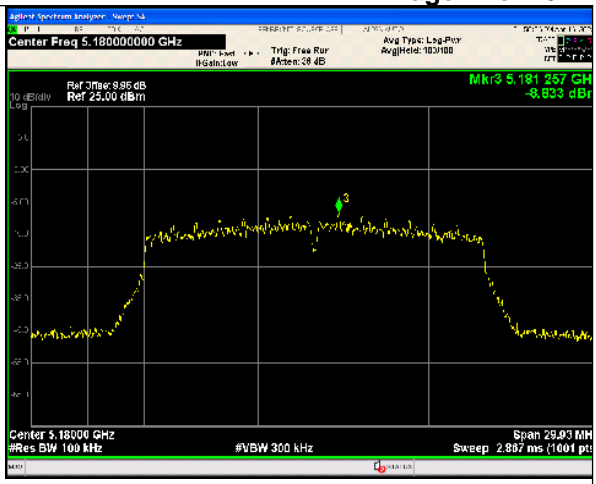
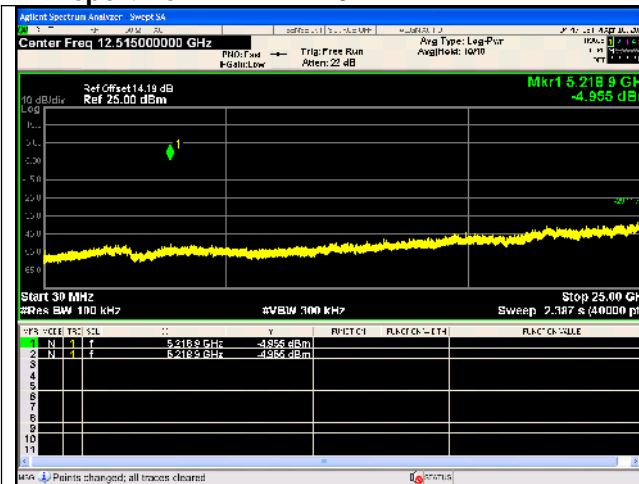

Spurious Emission  
 IEEE 802.11a\_Channel 44\_20MHz\_Antenna 0

In-Band Reference Level  
 IEEE 802.11n\_Channel 36\_20MHz\_Antenna 0

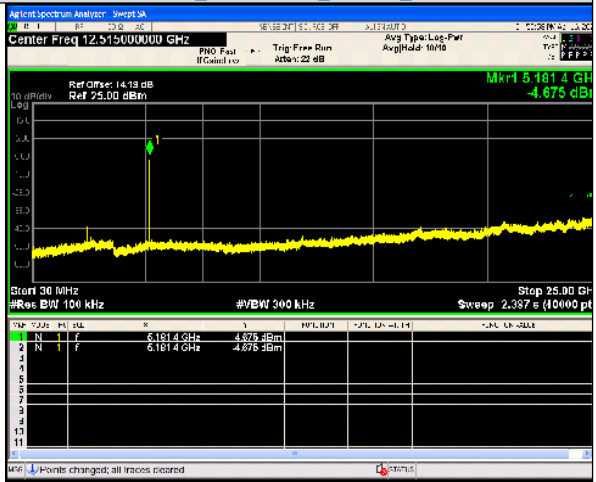
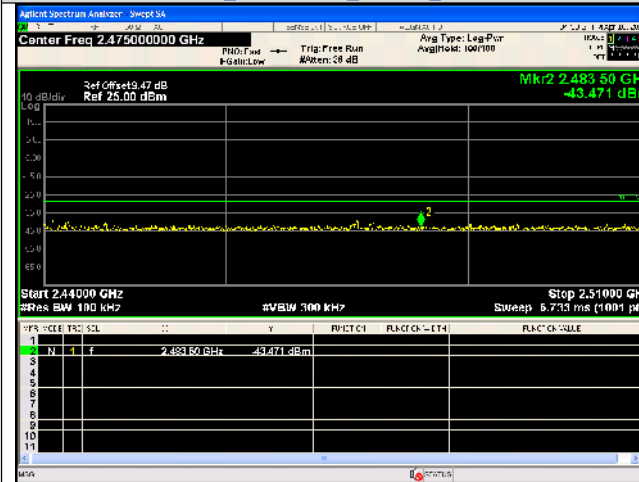

Out Of Band Emission  
 IEEE 802.11n\_Channel 36\_20MHz\_Antenna 0

Spurious Emission  
 IEEE 802.11n\_Channel 36\_20MHz\_Antenna 0

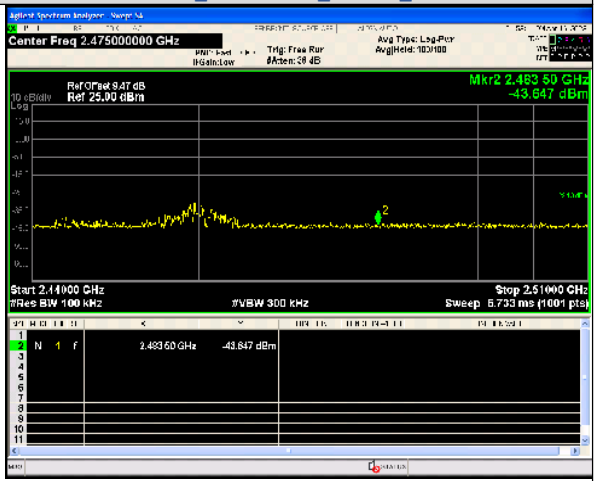
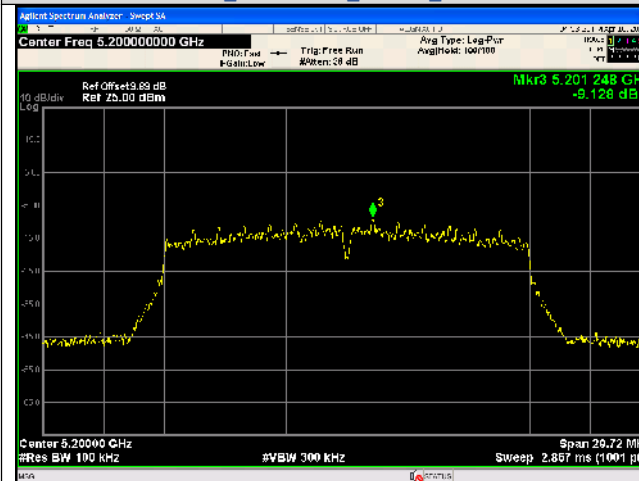

In-Band Reference Level  
 IEEE 802.11n\_Channel 40\_20MHz\_Antenna 0

Out Of Band Emission  
 IEEE 802.11n\_Channel 40\_20MHz\_Antenna 0

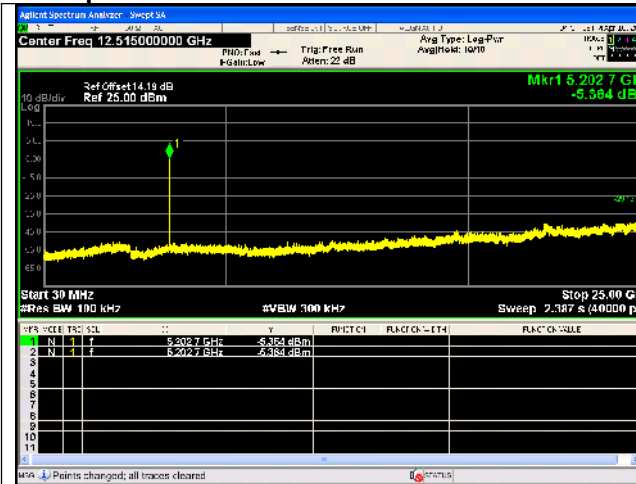

Spurious Emission  
 IEEE 802.11n\_Channel 40\_20MHz\_Antenna 0



In-Band Reference Level  
 IEEE 802.11n\_Channel 44\_20MHz\_Antenna 0

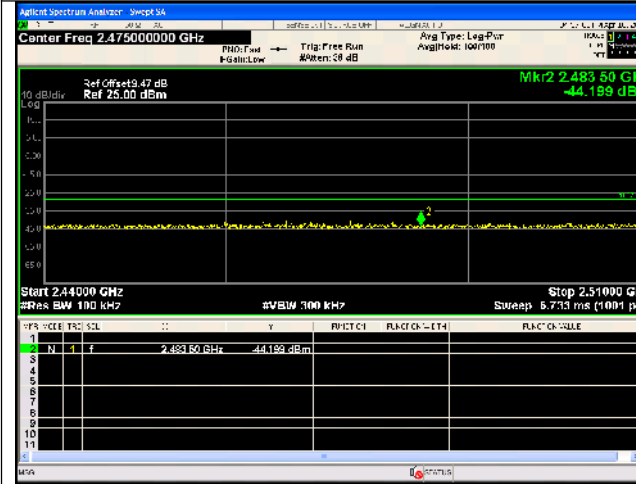

Out Of Band Emission  
 IEEE 802.11n\_Channel 44\_20MHz\_Antenna 0

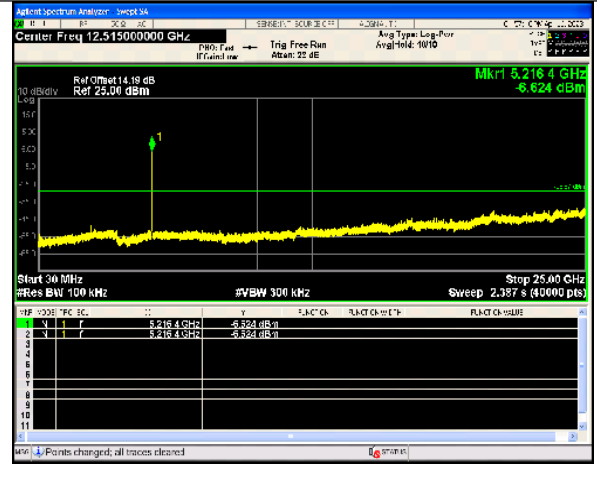

Spurious Emission  
 IEEE 802.11n\_Channel 44\_20MHz\_Antenna 0

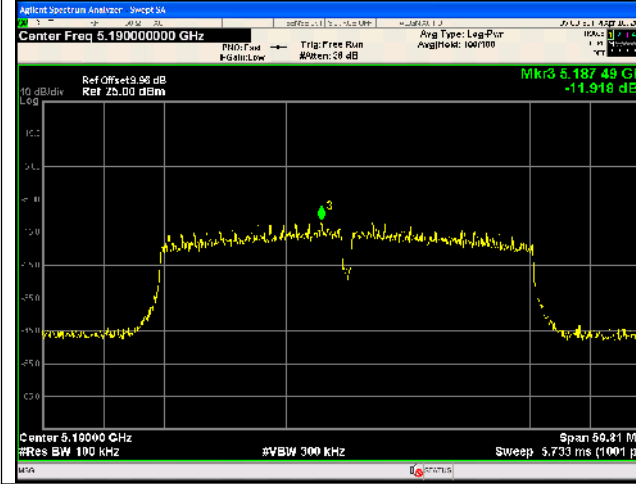

In-Band Reference Level  
 IEEE 802.11n\_Channel 38\_40MHz\_Antenna 0

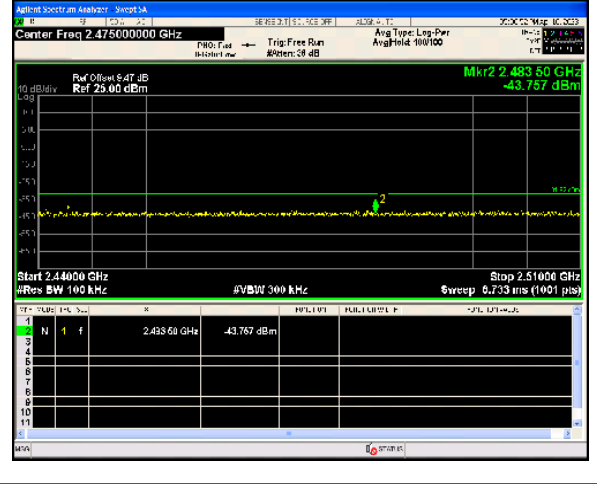

Out Of Band Emission  
 IEEE 802.11n\_Channel 38\_40MHz\_Antenna 0

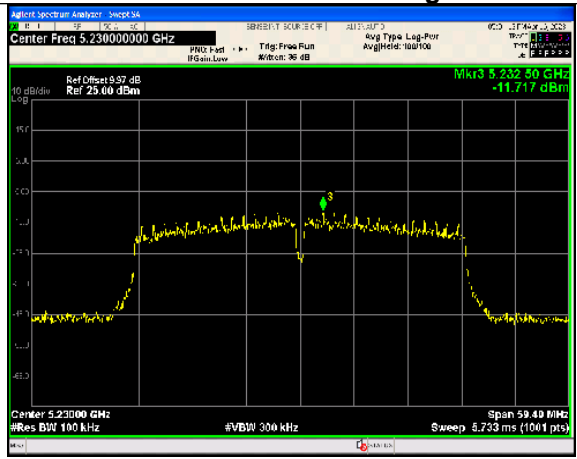
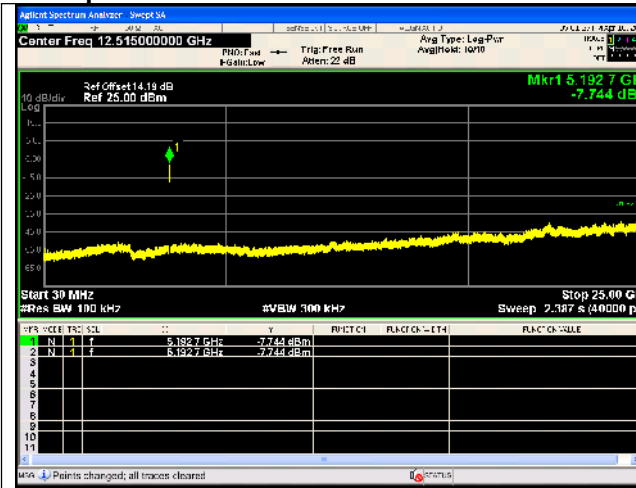

Spurious Emission  
 IEEE 802.11n\_Channel 38\_40MHz\_Antenna 0

In-Band Reference Level  
 IEEE 802.11n\_Channel 46\_40MHz\_Antenna 0

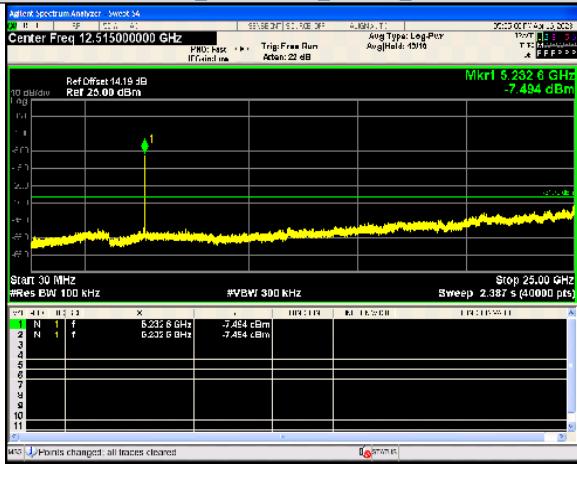
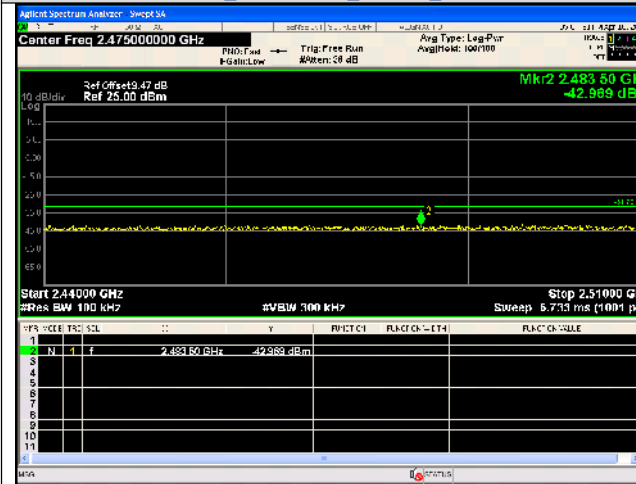

Out Of Band Emission  
 IEEE 802.11n\_Channel 46\_40MHz\_Antenna 0

Spurious Emission  
 IEEE 802.11n\_Channel 46\_40MHz\_Antenna 0

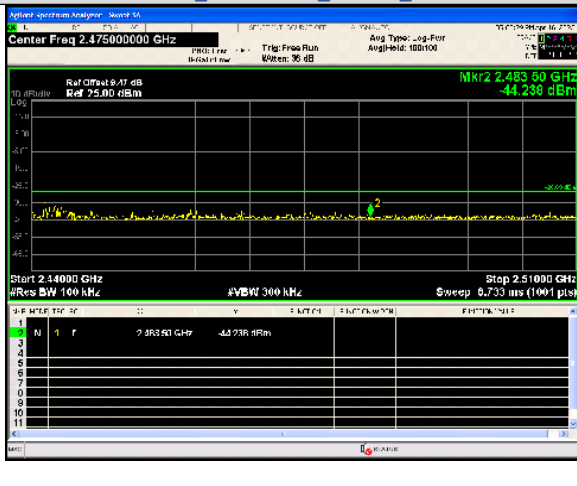
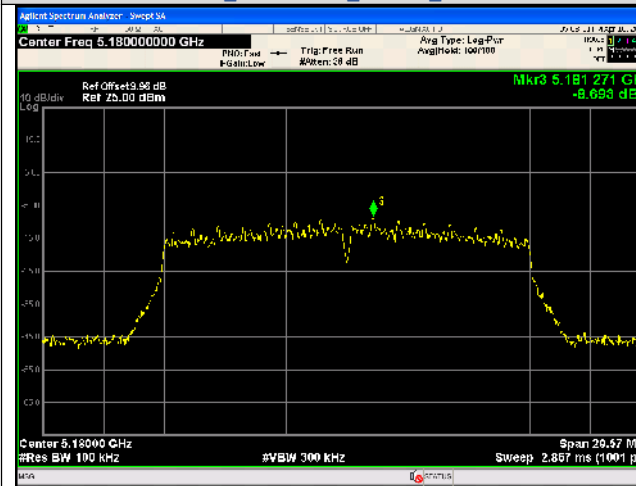

In-Band Reference Level  
 IEEE 802.11ac\_Channel 36\_20MHz\_Antenna 0

Out Of Band Emission  
 IEEE 802.11ac\_Channel 36\_20MHz\_Antenna 0



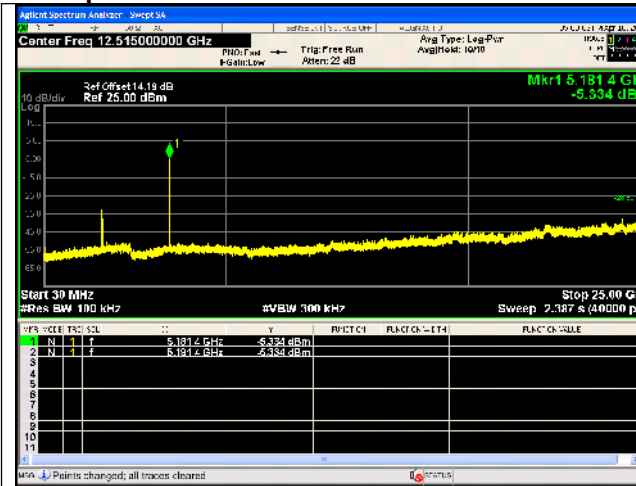

Spurious Emission  
 IEEE 802.11ac\_Channel 36\_20MHz\_Antenna 0

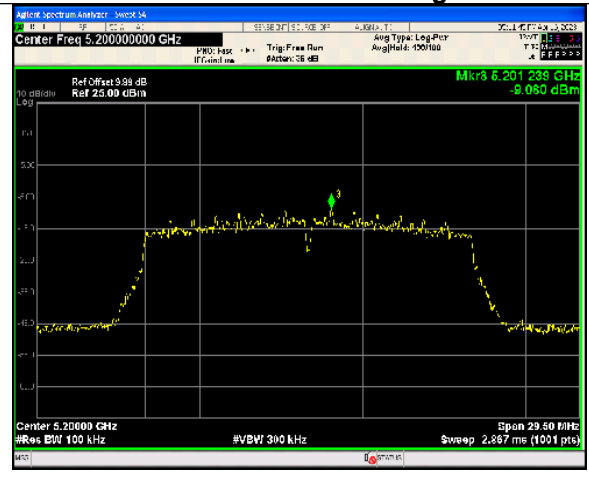

In-Band Reference Level  
 IEEE 802.11ac\_Channel 40\_20MHz\_Antenna 0

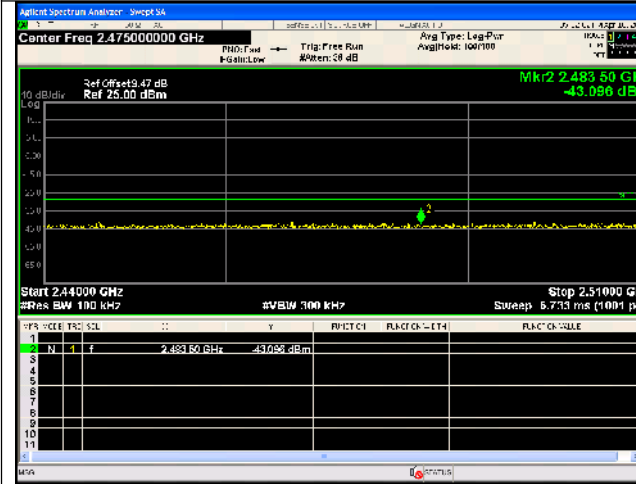

Out Of Band Emission  
 IEEE 802.11ac\_Channel 40\_20MHz\_Antenna 0

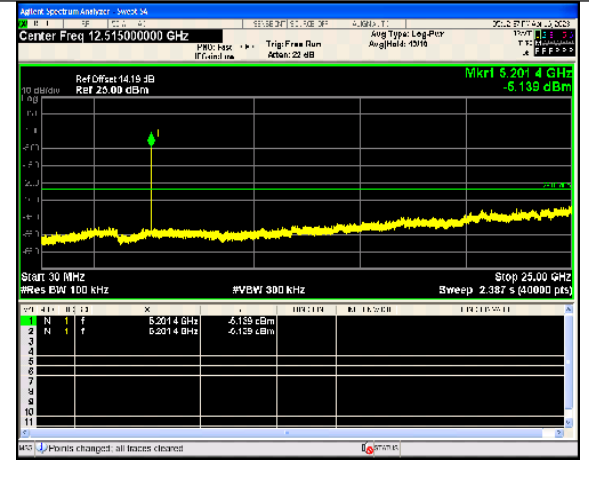

Spurious Emission  
 IEEE 802.11ac\_Channel 40\_20MHz\_Antenna 0

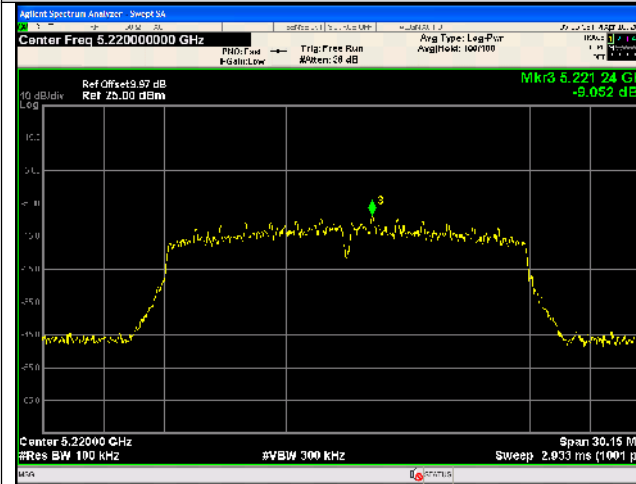

In-Band Reference Level  
 IEEE 802.11ac\_Channel 44\_20MHz\_Antenna 0

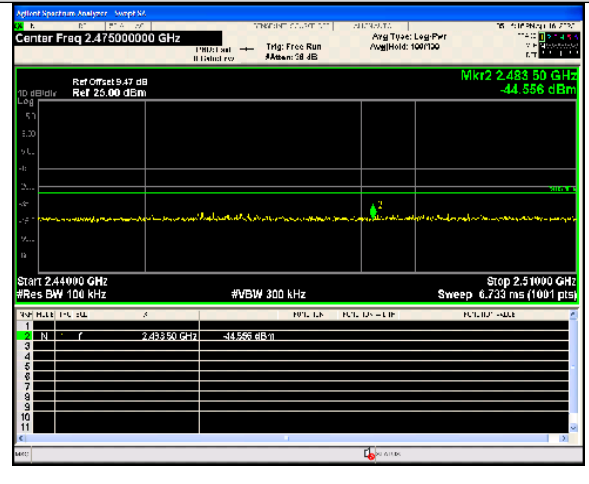

Out Of Band Emission  
 IEEE 802.11ac\_Channel 44\_20MHz\_Antenna 0

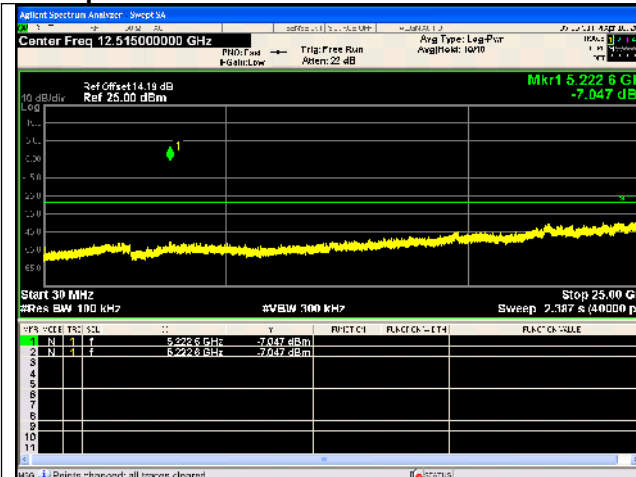

Spurious Emission  
IEEE 802.11ac\_Channel 44\_20MHz\_Antenna 0

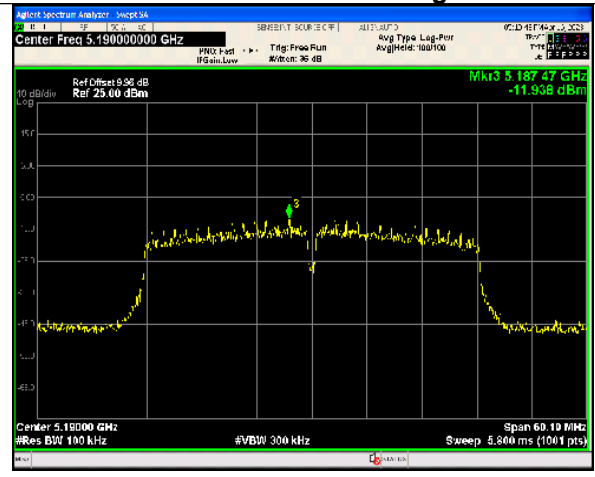

In-Band Reference Level  
IEEE 802.11ac\_Channel 38\_40MHz\_Antenna 0

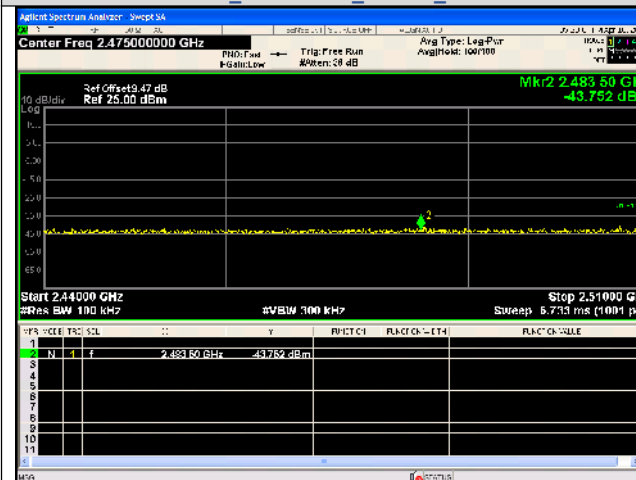

Out Of Band Emission  
IEEE 802.11ac\_Channel 38\_40MHz\_Antenna 0

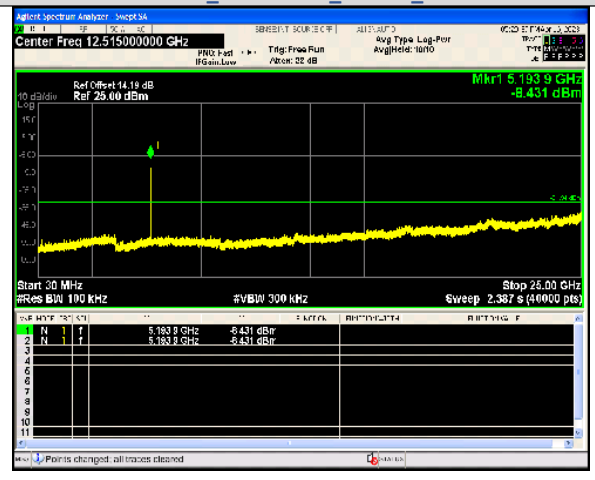

Spurious Emission  
IEEE 802.11ac\_Channel 38\_40MHz\_Antenna 0

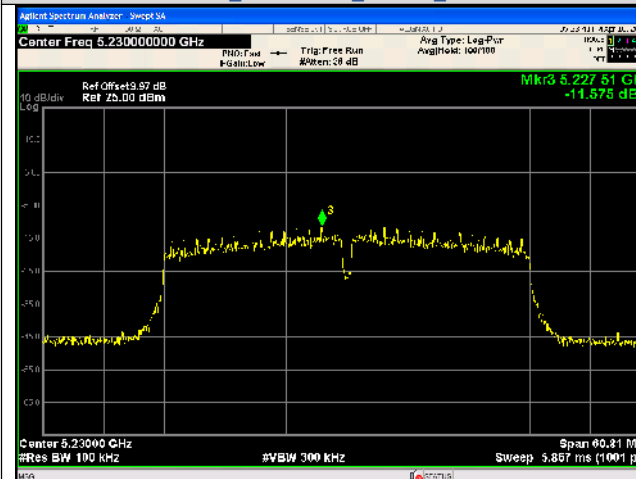

In-Band Reference Level  
IEEE 802.11ac\_Channel 46\_40MHz\_Antenna 0

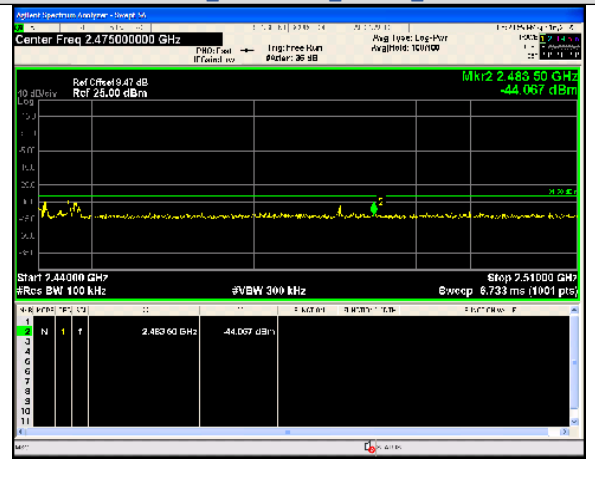

Out Of Band Emission  
IEEE 802.11ac\_Channel 46\_40MHz\_Antenna 0

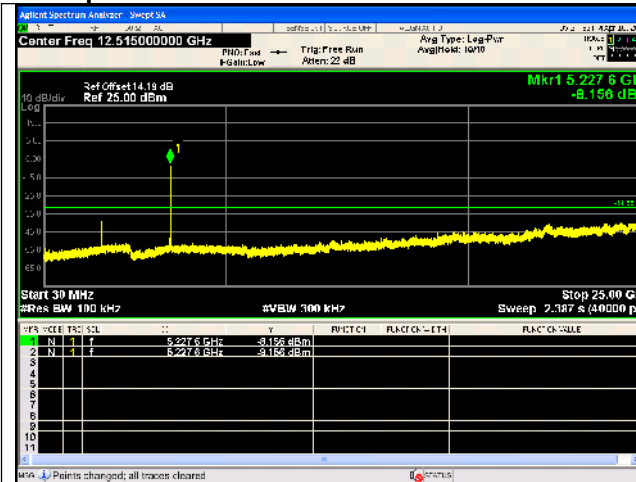

Spurious Emission  
 IEEE 802.11ac\_Channel 46\_40MHz\_Antenna 0

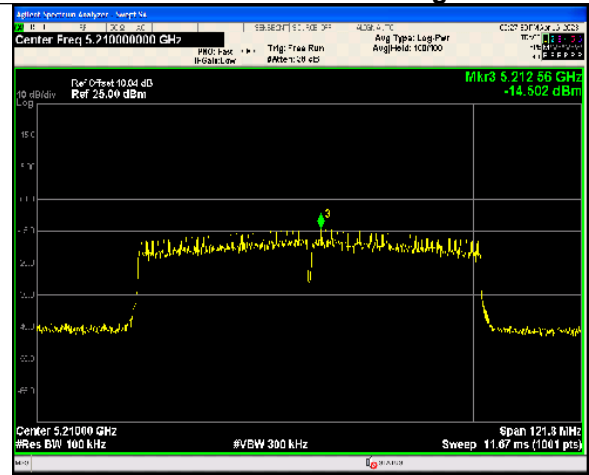

In-Band Reference Level  
 IEEE 802.11ac\_Channel 42\_80MHz\_Antenna 0

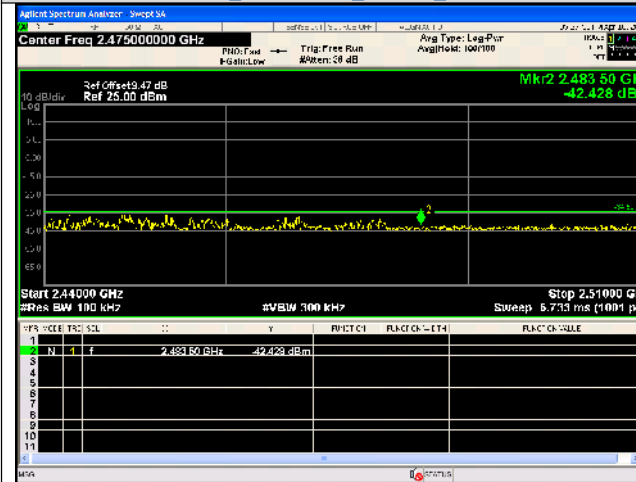

Out Of Band Emission  
 IEEE 802.11ac\_Channel 42\_80MHz\_Antenna 0

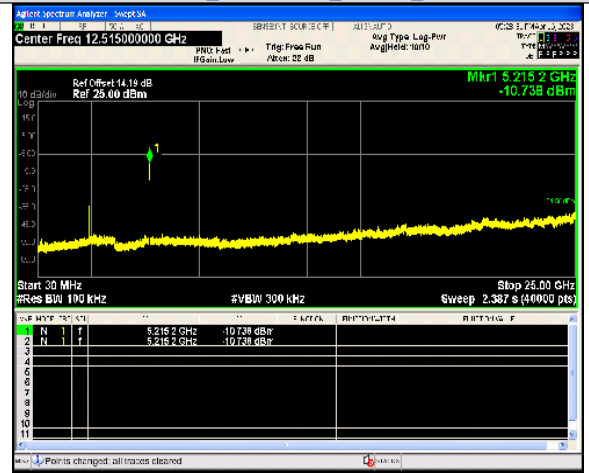

Spurious Emission  
 IEEE 802.11ac\_Channel 42\_80MHz\_Antenna 0

## APPENDIX VI. Duty Cycle

### Test Result

| Mode             | Data rates | Channel | On Time (ms) | Period (ms) | Duty Cycle (%) | Duty Cycle (linear) | Duty Cycle Factor (dB) |
|------------------|------------|---------|--------------|-------------|----------------|---------------------|------------------------|
| IEEE 802.11a     | 54         | 36      | 0.077        | 0.077       | 99.91          | 0.9991              | 0.0039                 |
|                  |            | 40      | 0.176        | 0.221       | 79.93          | 0.7993              | 0.9729                 |
|                  |            | 44      | 0.033        | 0.033       | 99.97          | 0.9997              | 0.0013                 |
| IEEE 802.11n_20  | MCS 7      | 36      | 0.121        | 0.121       | 100.00         | 1.0000              | 0.0                    |
|                  |            | 40      | 0.129        | 0.129       | 99.97          | 0.9997              | 0.0013                 |
|                  |            | 44      | 0.164        | 0.209       | 78.79          | 0.7879              | 1.0353                 |
| IEEE 802.11n_40  | MCS 7      | 38      | 0.033        | 0.033       | 99.95          | 0.9995              | 0.0022                 |
|                  |            | 46      | 0.022        | 0.022       | 99.96          | 0.9996              | 0.0017                 |
| IEEE 802.11ac_20 | MCS 9      | 36      | 0.068        | 0.068       | 100.00         | 1.0000              | 0.0                    |
|                  |            | 40      | 0.098        | 0.098       | 100.00         | 1.0000              | 0.0                    |
|                  |            | 44      | 0.044        | 0.044       | 100.00         | 1.0000              | 0.0                    |
| IEEE 802.11ac_40 | MCS 9      | 38      | 0.020        | 0.020       | 100.00         | 1.0000              | 0.0                    |
| 46               |            | 0.002   | 0.002        | 98.92       | 0.9892         | 0.0472              |                        |
| IEEE 802.11ac_80 | MCS 9      | 42      | 0.004        | 0.004       | 99.83          | 0.9983              | 0.0074                 |

### Test Graphs

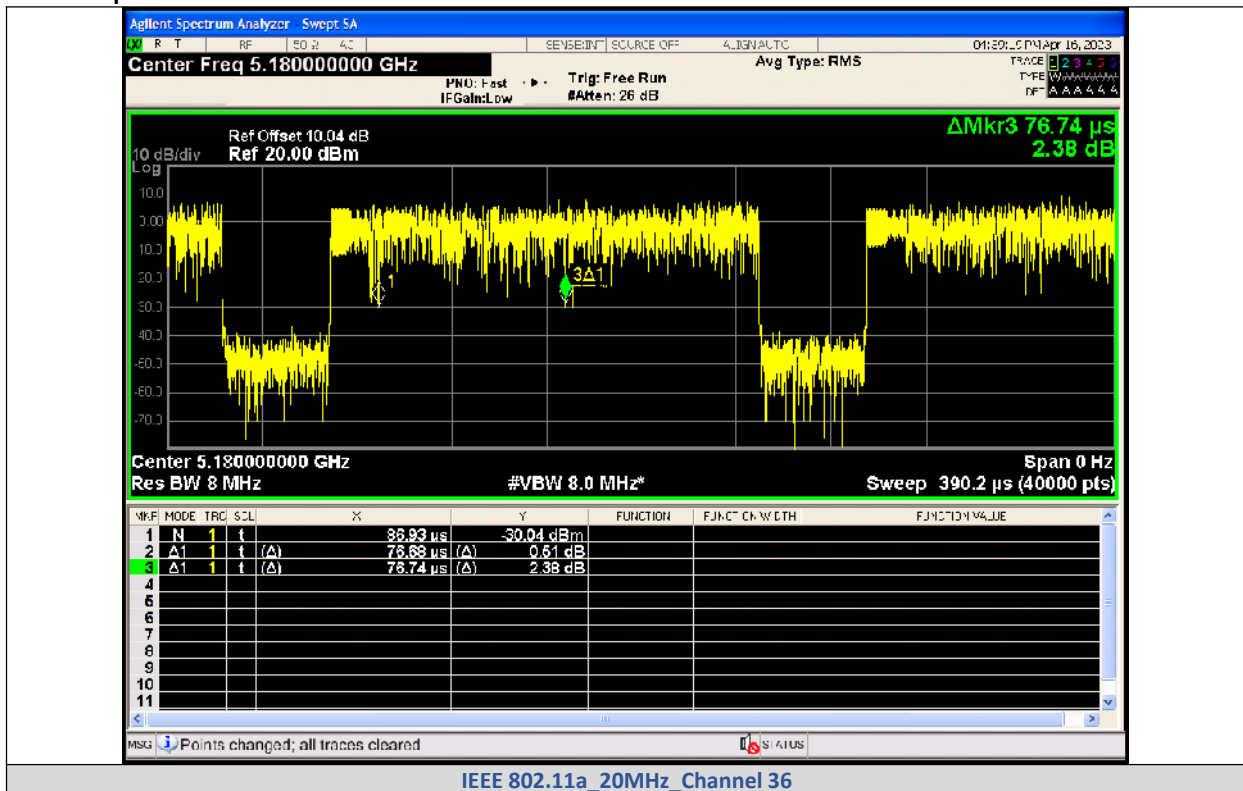

IEEE 802.11a\_20MHz\_Channel 36

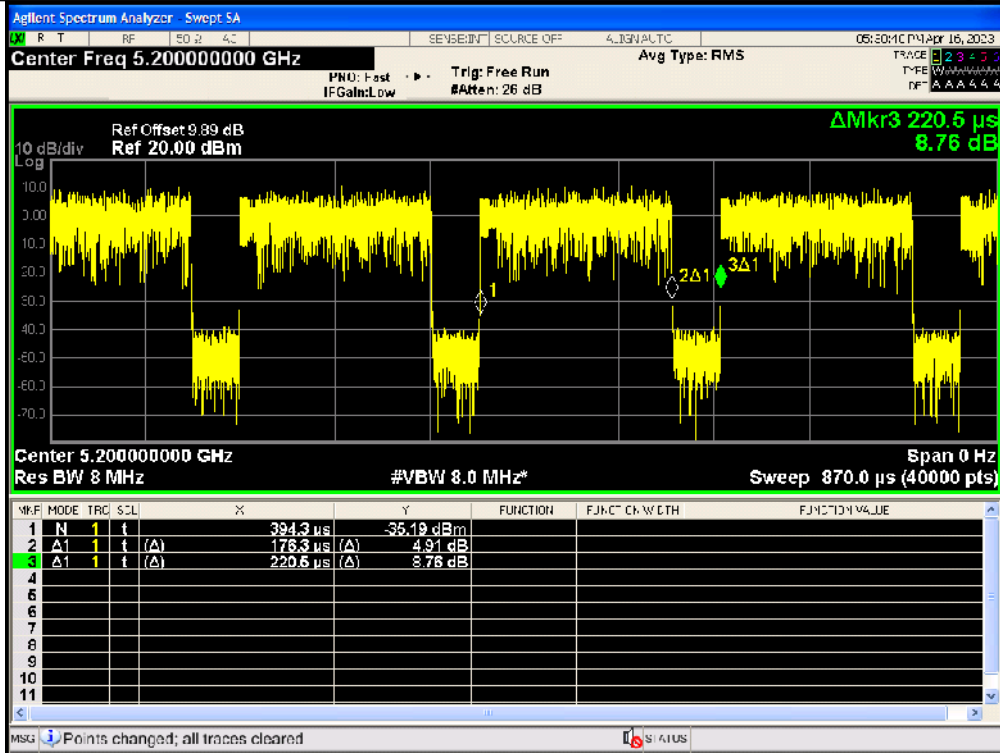

IEEE 802.11a\_20MHz\_Channel 40

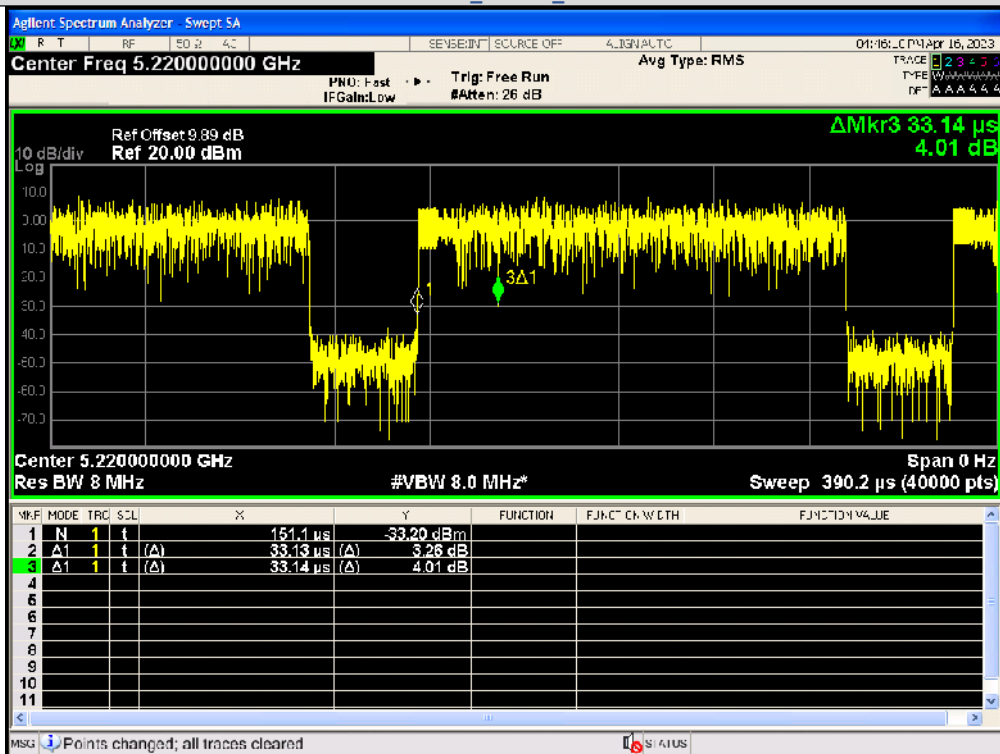

IEEE 802.11a\_20MHz\_Channel 44

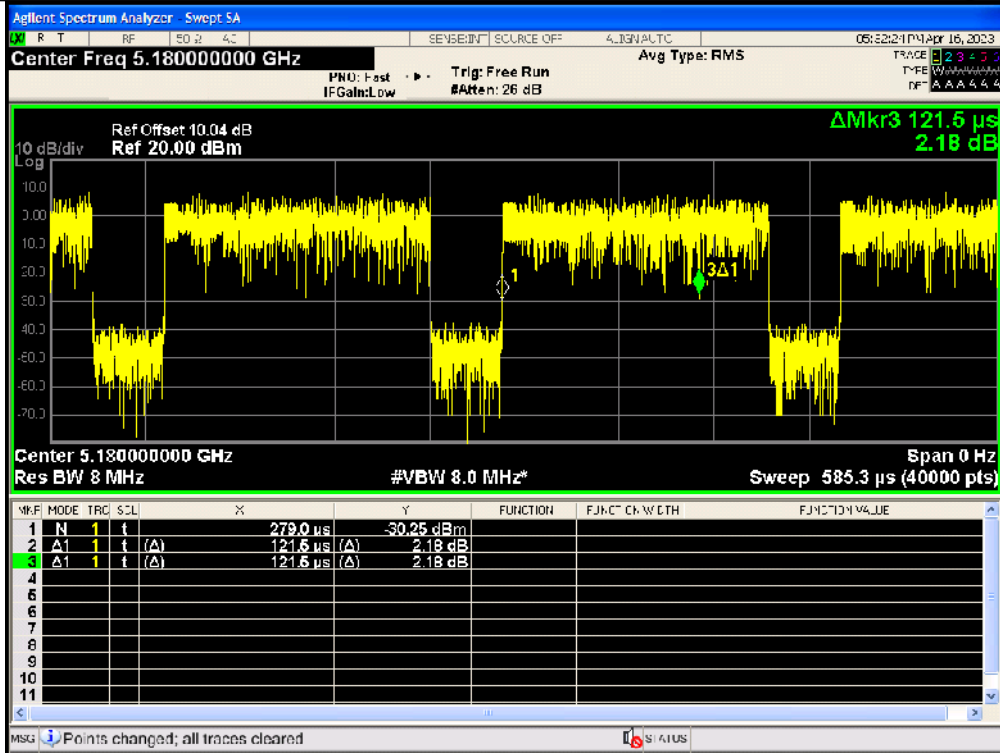

IEEE 802.11n\_20MHz\_Channel 36

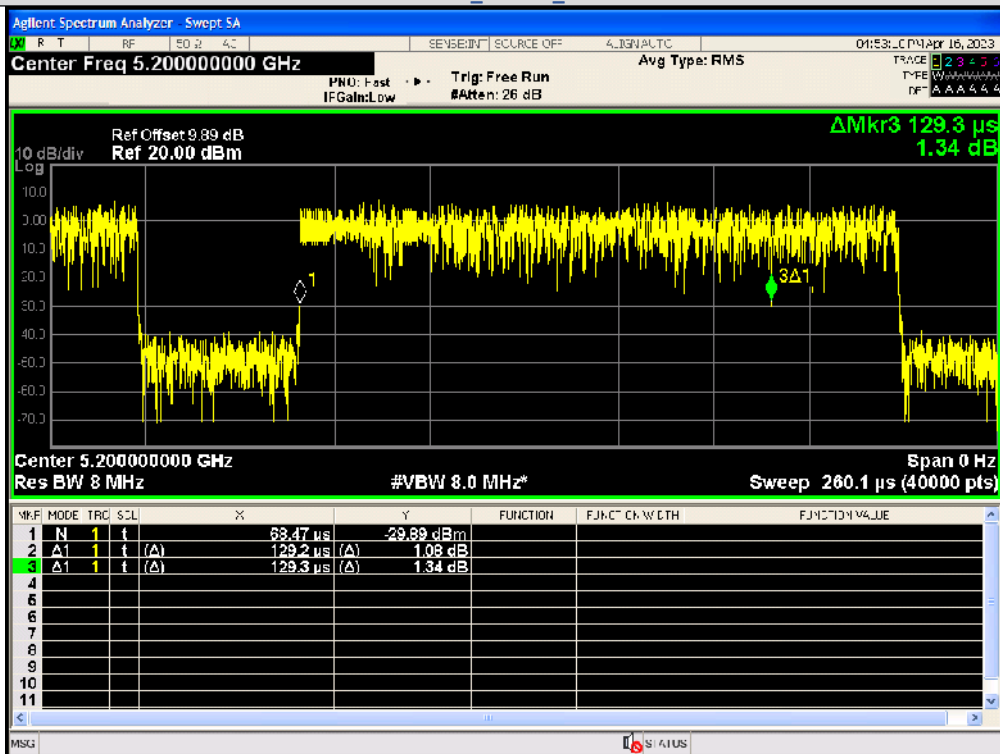

IEEE 802.11n\_20MHz\_Channel 40

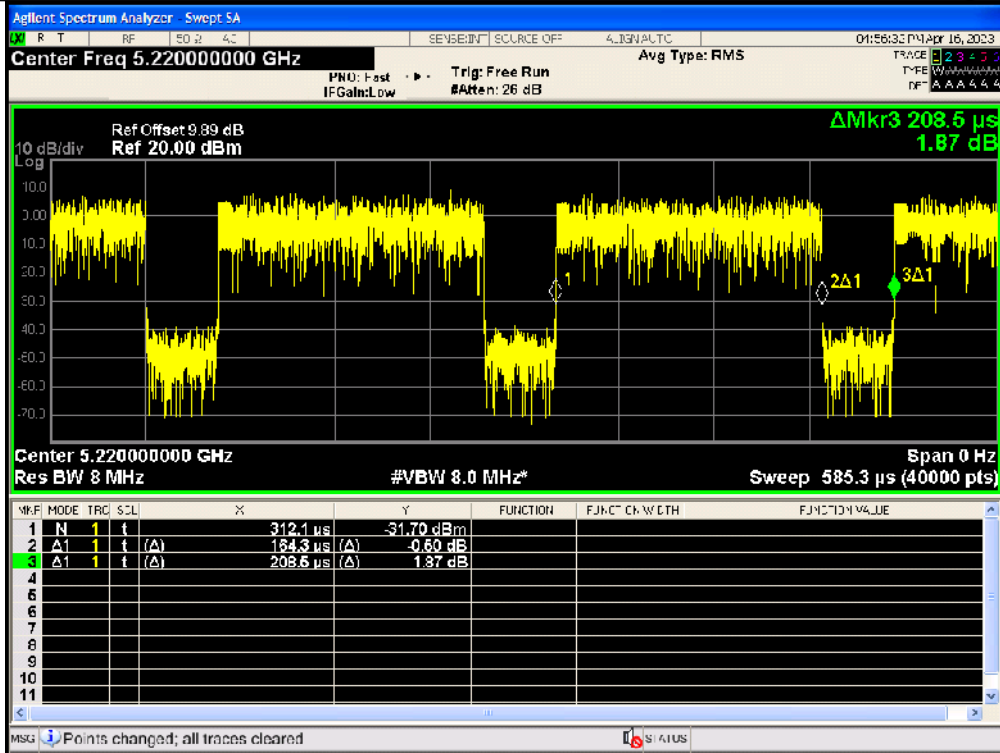

IEEE 802.11n 20MHz Channel 44

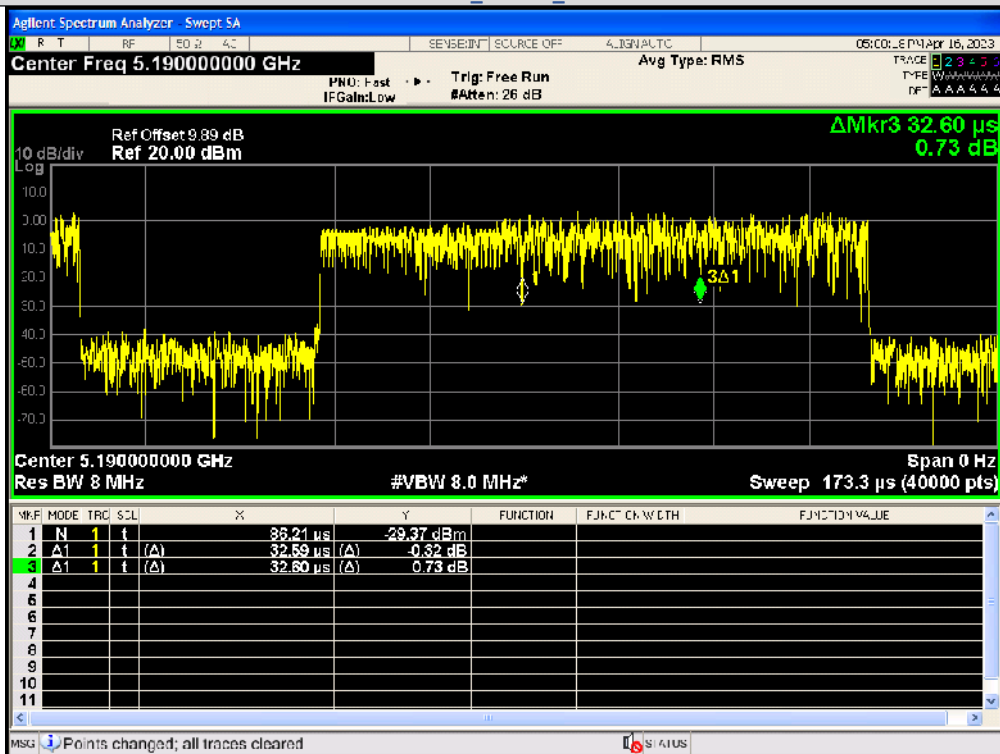

IEEE 802.11n 40MHz Channel 38

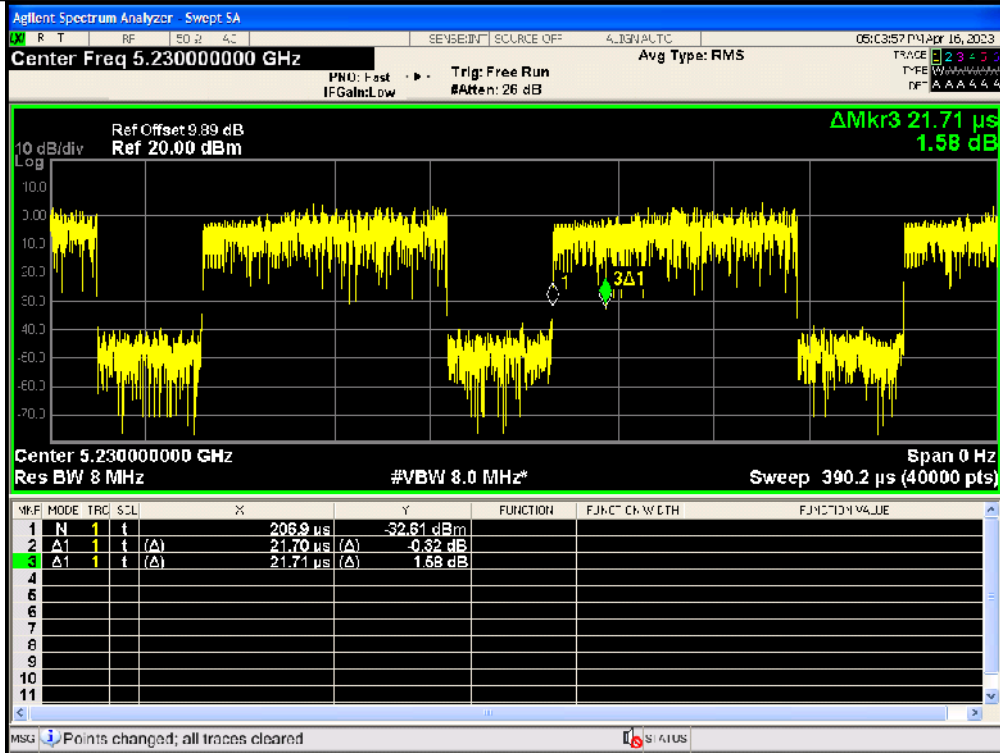

IEEE 802.11n 40MHz Channel 46

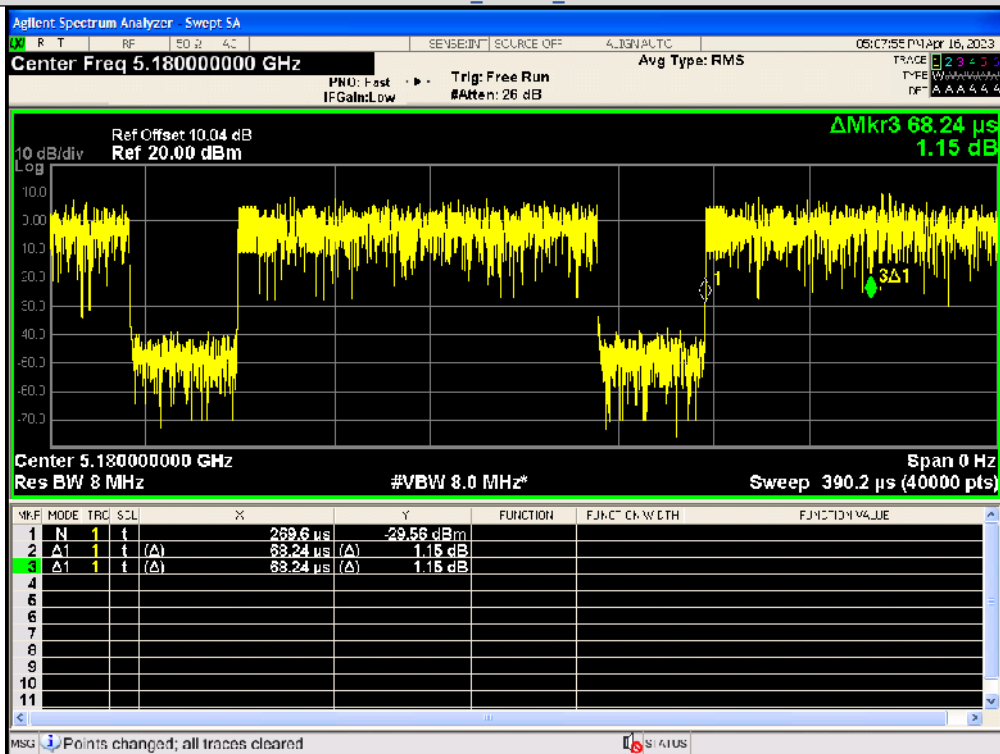

IEEE 802.11ac 20MHz Channel 36



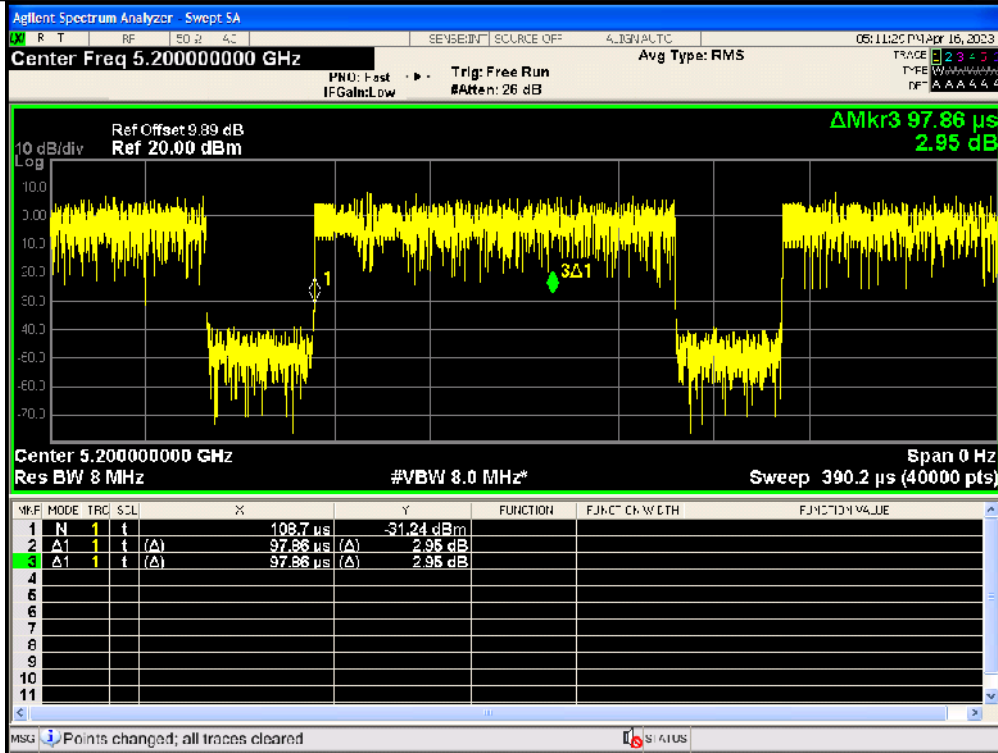

IEEE 802.11ac\_20MHz\_Channel 40

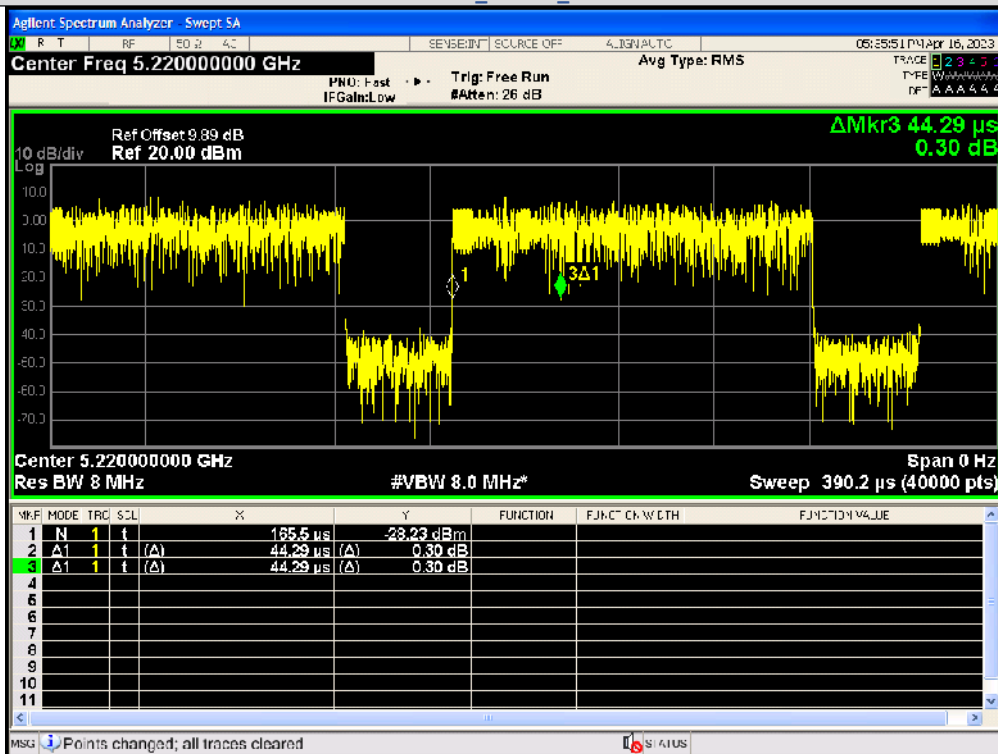

IEEE 802.11ac\_20MHz\_Channel 44

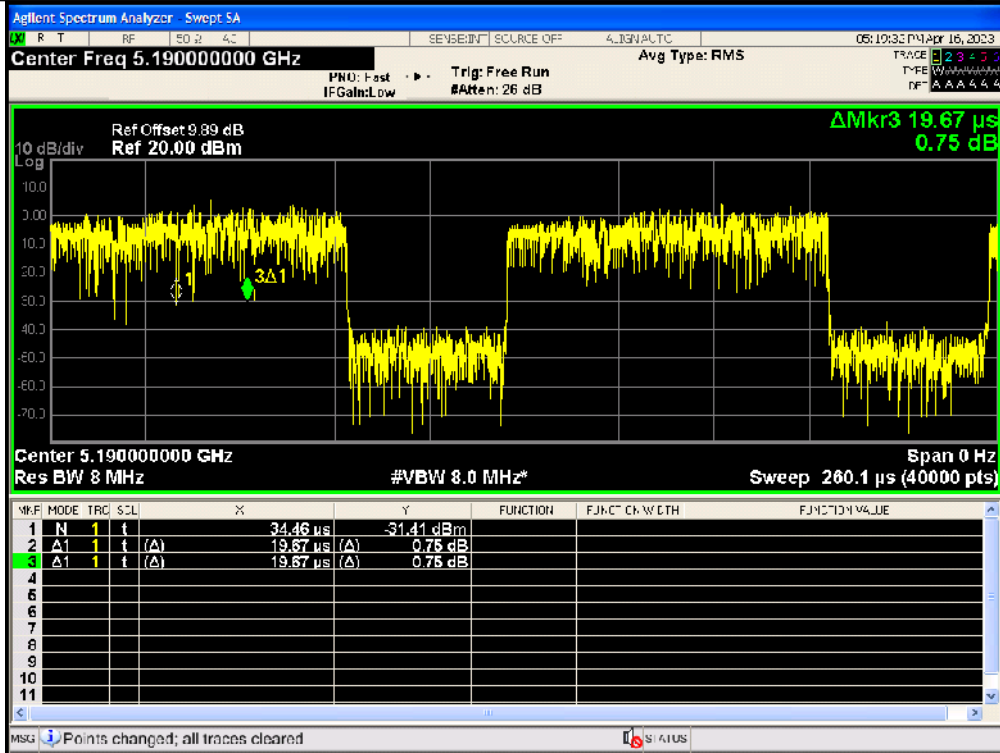

IEEE 802.11ac\_40MHz\_Channel 38

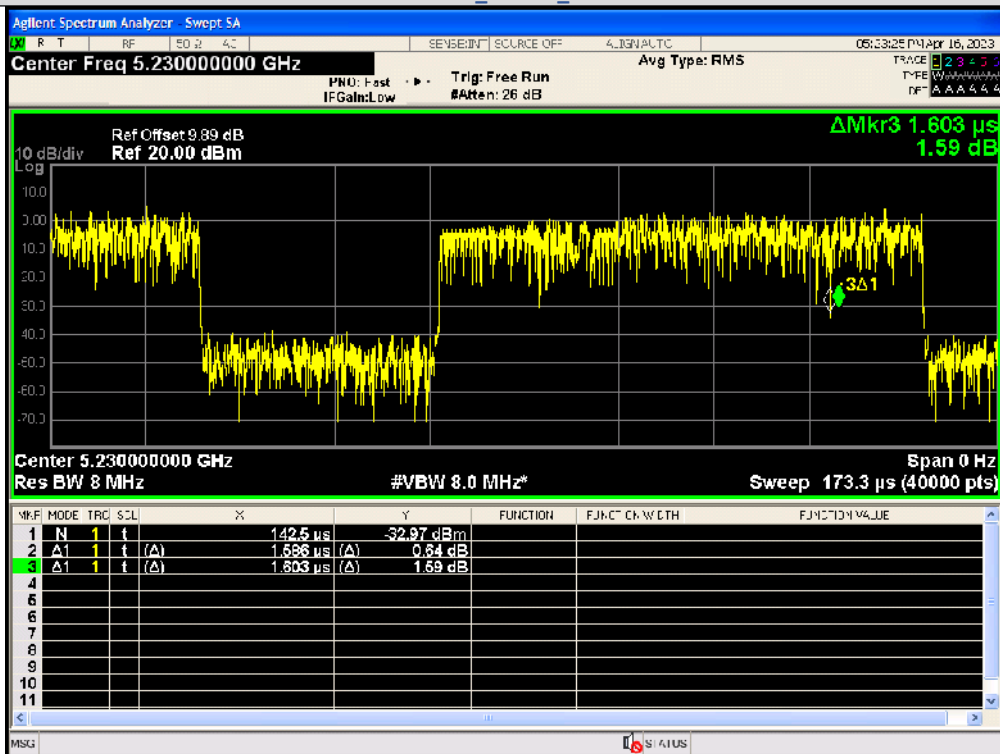

IEEE 802.11ac\_40MHz\_Channel 46

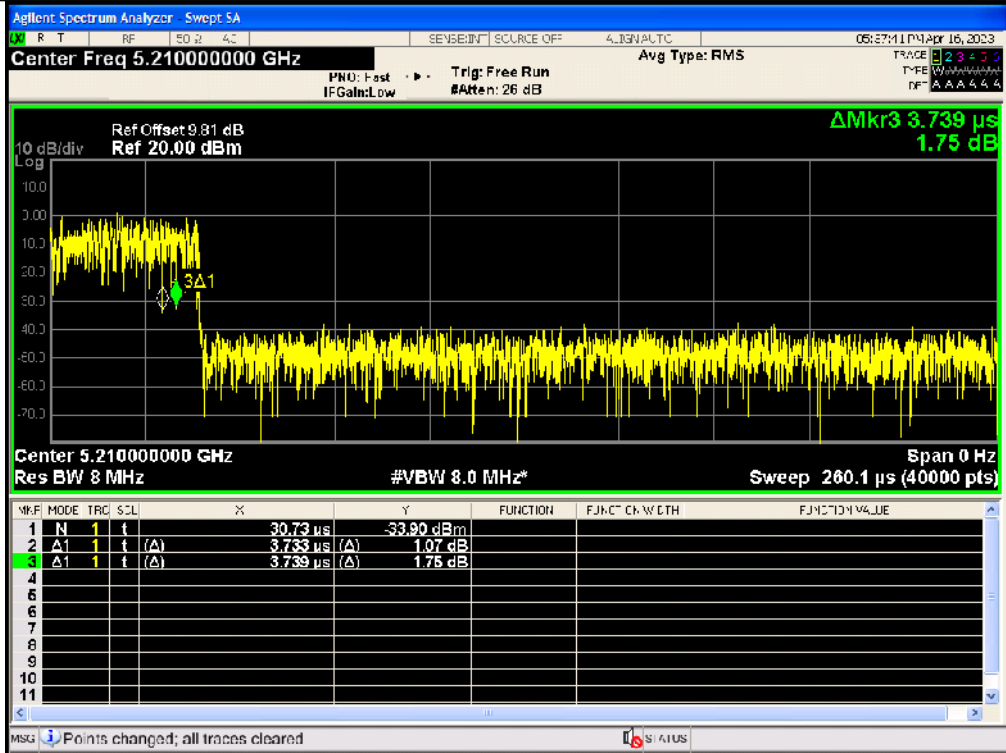

IEEE 802.11ac\_80MHz\_Channel 42

# APPENDIX VII. Peak Power Spectral Density

## Test Result

| Mode             | Channel | Ant. 0 Meas PSD (dBm/MHz or dBm/0.5MHz) | Ant. 0 Corr'd PSD (dBm/MHz or dBm/0.5MHz) | Limit (dBm/MHz or dBm/0.5MHz) | Result |
|------------------|---------|---|---|-------------------------------|--------|
| IEEE 802.11a     | 36      | -9.489                                  | -8.516                                    | 11                            | PASS   |
|                  | 40      | -7.642                                  | -6.669                                    |                               | PASS   |
|                  | 44      | -9.592                                  | -8.619                                    |                               | PASS   |
| IEEE 802.11n_20  | 36      | -9.780                                  | -9.78                                     |                               | PASS   |
|                  | 40      | -10.076                                 | -10.076                                   |                               | PASS   |
|                  | 44      | -9.872                                  | -9.872                                    |                               | PASS   |
| IEEE 802.11n_40  | 38      | -13.363                                 | -13.361                                   |                               | PASS   |
|                  | 46      | -12.622                                 | -12.62                                    |                               | PASS   |
| IEEE 802.11ac_20 | 36      | -9.847                                  | -9.847                                    |                               | PASS   |
|                  | 40      | -9.976                                  | -9.976                                    |                               | PASS   |
|                  | 44      | -9.619                                  | -9.619                                    |                               | PASS   |
| IEEE 802.11ac_40 | 38      | -13.340                                 | -13.293                                   | PASS                          |        |
|                  | 46      | -13.602                                 | -13.555                                   | PASS                          |        |
| IEEE 802.11ac_80 | 42      | -17.545                                 | -17.538                                   | PASS                          |        |

## Test Graphs

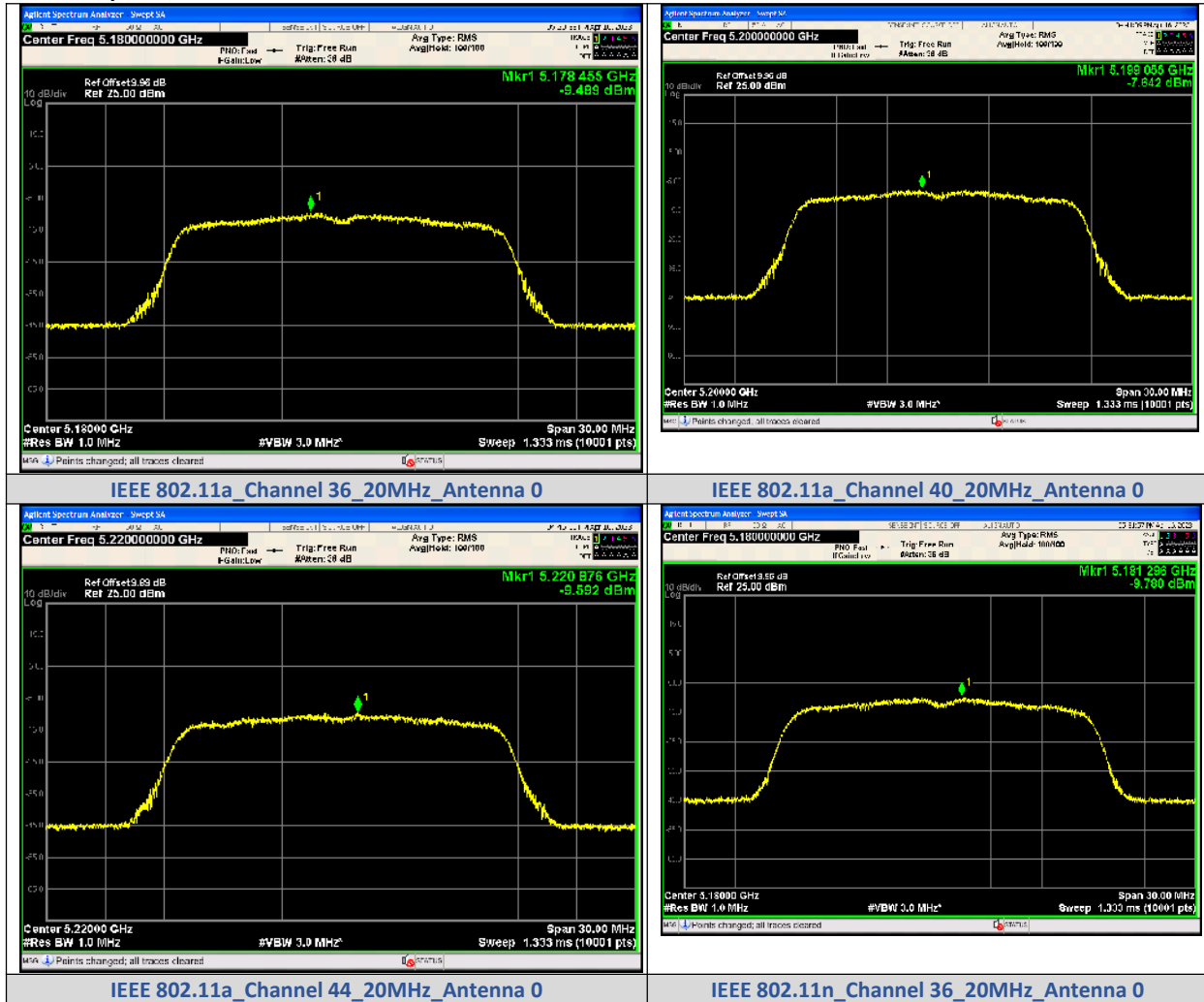



IEEE 802.11n Channel 40\_20MHz\_Antenna 0

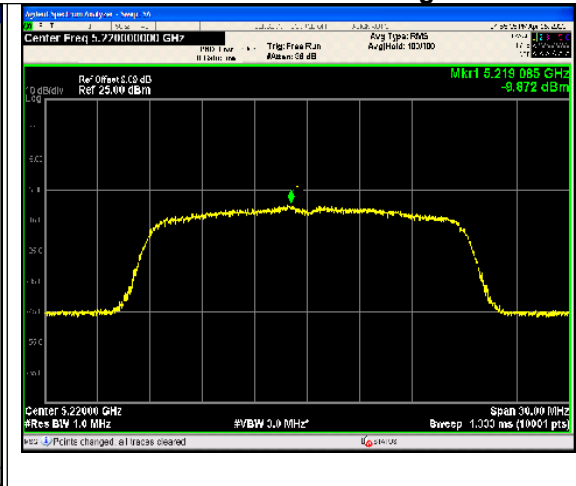

IEEE 802.11n Channel 44\_20MHz\_Antenna 0

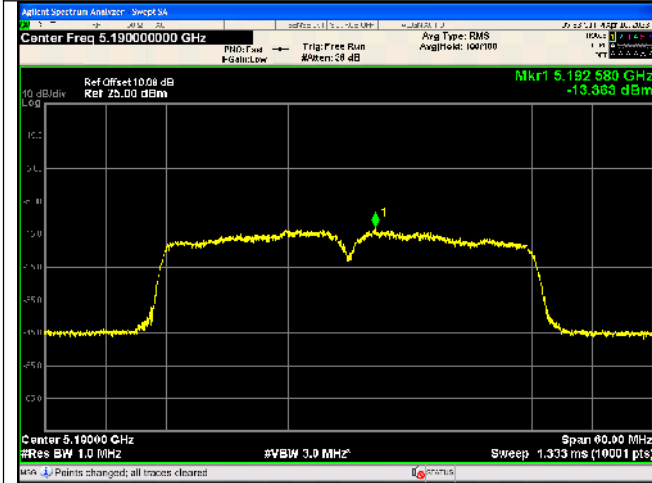

IEEE 802.11n Channel 38\_40MHz\_Antenna 0

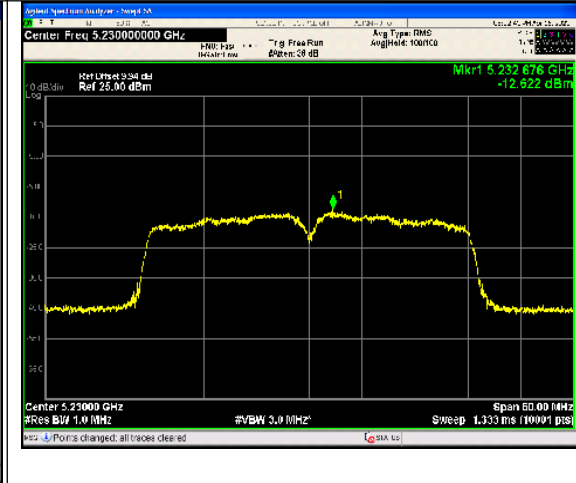

IEEE 802.11n Channel 46\_40MHz\_Antenna 0

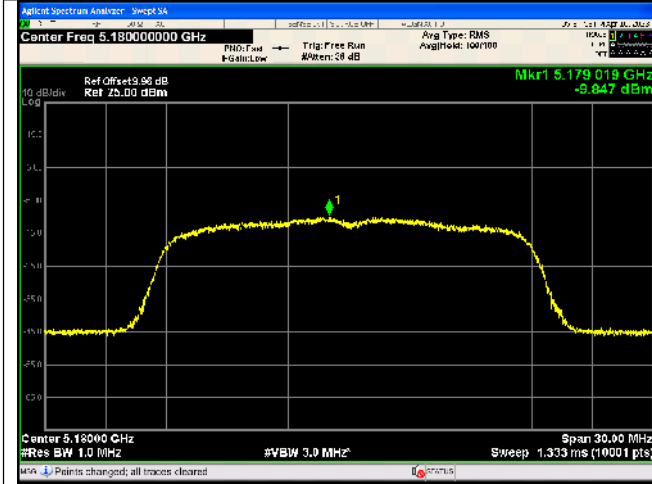

IEEE 802.11ac Channel 36\_20MHz\_Antenna 0

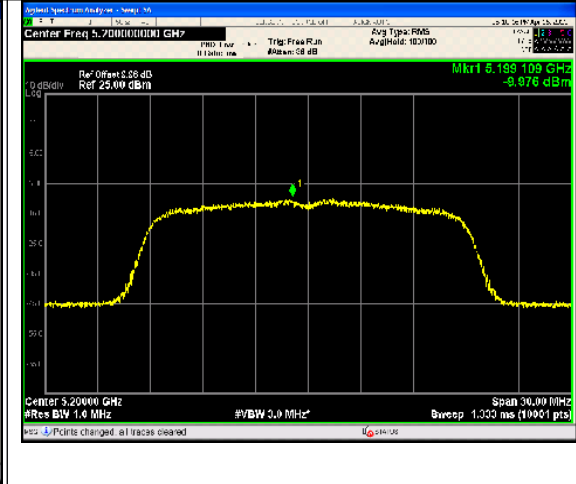

IEEE 802.11ac Channel 40\_20MHz\_Antenna 0

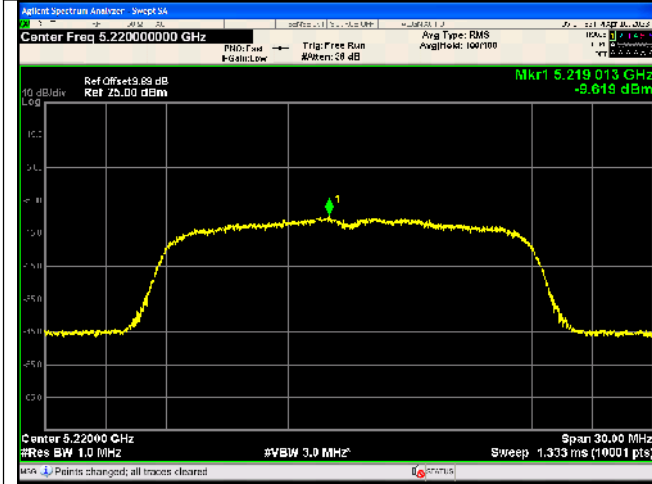

IEEE 802.11ac Channel 44\_20MHz\_Antenna 0

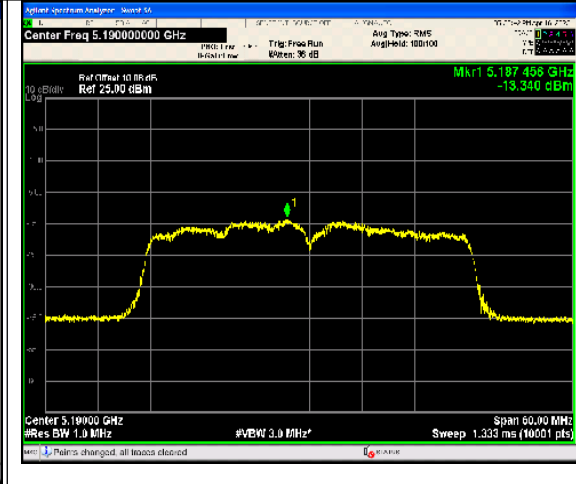

IEEE 802.11ac Channel 38\_40MHz\_Antenna 0

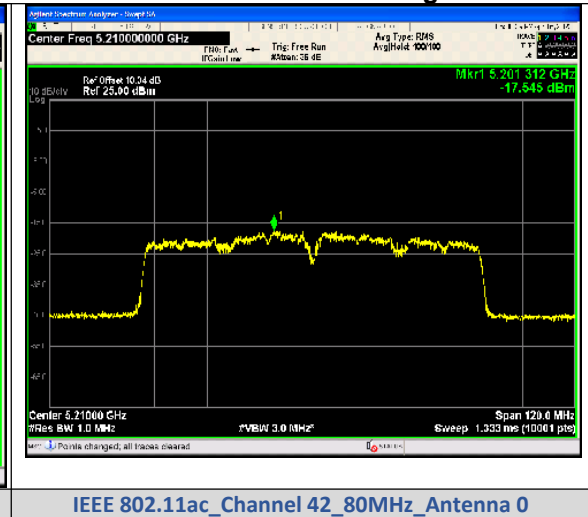
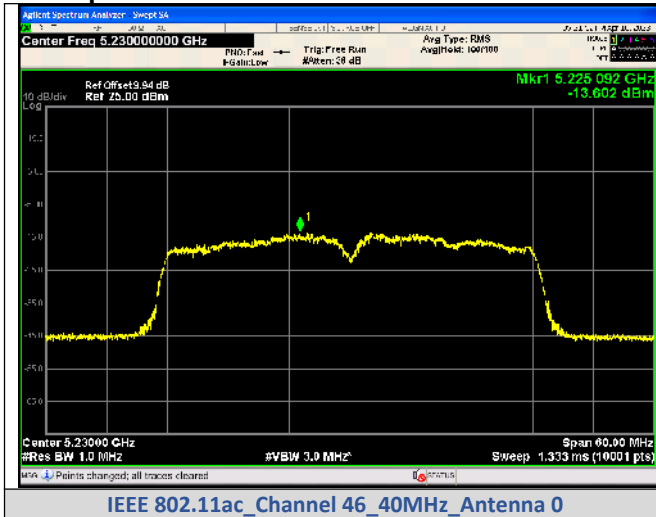

IEEE 802.11ac\_Channel 46\_40MHz\_Antenna 0

IEEE 802.11ac\_Channel 42\_80MHz\_Antenna 0

\*\*\*\*\* End of Report \*\*\*\*\*