

## Antenna Specifications

1. Manufacture: DONGGUAN KIMCHEN INDUSTRY INTL LIMITED
2. Model number: 20.5\*42\*0.08\*105P\*10TS\*10mm
3. Floor plan: unit: MM

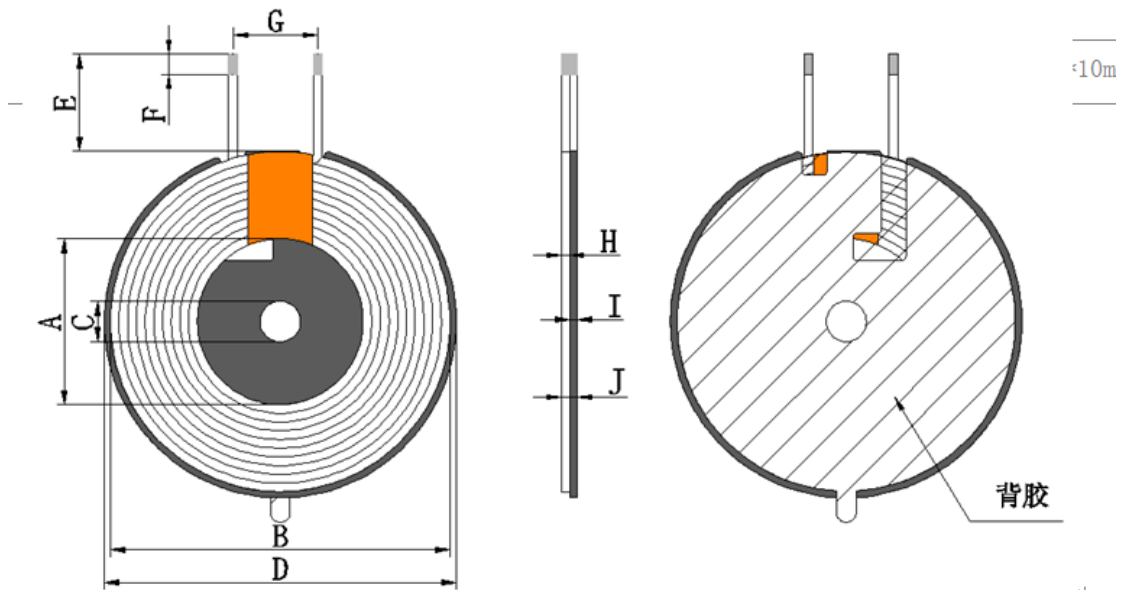

A	B	C	D	E	F	G	H	I	J
20.5±0.5	42±1	5.0±0.5	43.5±0.5	10±1	3±1	10±2	1.25max	1.0±0.1	2.8max

#### 4. Product parameters

Antenna Gain: 0dBi

Line diameter: 0.08x105

Number of turns: 10

