

MASSAGE CHAIR

G600-8 Operation Instructions

SAVE THESE INSTRUCTIONS

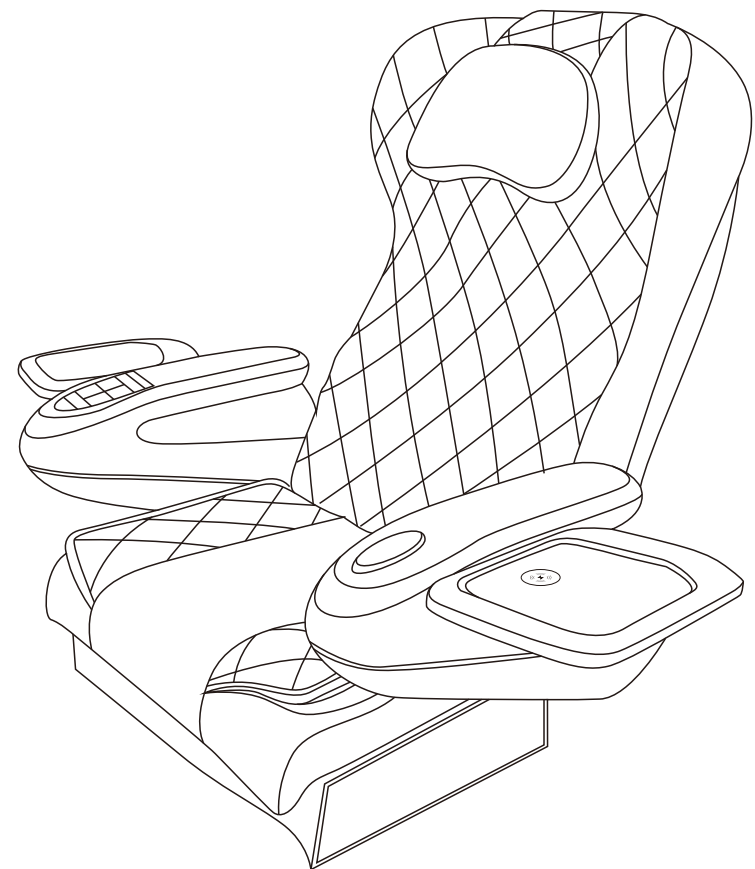

Thanks for purchasing this product. Please read this manual instruction carefully in order to know how to use this product correctly before operation. Please pay more attention to some important safety warning and keep this manual book properly for future use.

Note: Our Company reserves the right to revise the design and description of this product without any further notice. Please refer to the actual color of this product.

CONTENTS

Important Safety Warning	02
Instructions de securite importantes	04
Massage System Lnstallation	06
Name and function of components	07
Function	08
Method of usage	09
Product specification	16

IMPORTANT SAFETY INSTRUCTIONS

Warning:

This product can expose you to chemicals including lead which are known to the State of California to cause cancer or birth defects or other reproductive harms. For more information go to www.P65Warnings.ca.gov/furniture.

When using an electrical appliance, basic precautions should always be followed, including the following:

Read all instructions before using (this appliance)

DANGER-To reduce the risk of electric shock:

1) Always unplug this appliance from the electrical outlet immediately after using and before cleaning.

WARNING-To reduce the risk of burns, fire, electric shock, or injury to Persons:

- 1) An appliance should never be left unattended when plugged in. Unplug from outlet when not in use, and before putting on or taking off parts.
- 2) Do not operate under blanket or pillow. Excessive heating can occur and Cause fire, electric shock, or injury to persons.
- 3) Close supervision is necessary when this appliance is used by, on, or near children, invalids, or disabled persons.
- 4) Use the appliance only for its intended use as described in this manual. Do not use attachments not recommended by the manufacturer.
- 5) Never operate this appliance if it has a damaged cord or plug, if it is not working properly, if it has been dropped or damaged, or dropped into water. Return the appliance to a service center for examination and repair.
- 6) Do not carry this appliance by supply cord or use cord as a handle.
- 7) Keep the cord away from heated surfaces.
- 8) Never operate the appliance with the air openings blocked. Keep the air openings free of lint, hair, and the like.
- 9) Never drop or insert any object into any opening.
- 10) Do not use outdoors.
- 11) Do not operate where aerosol (spray) products are being used or where oxygen is being administered.

Safety and maintenance

- 12) To disconnect, turn all controls to the off position, then remove plug from outlet.
- 13) The appliance is intended for household and indoor use only.
- 14) Connect this appliance to a properly grounded outlet only ,see grounding instructions .
- 15)Keep children away from extended foot support (or other similar parts)
- 16)Do not use massager in close proximity to loose clothing or jewelry.
- 17)Keep long hair away from massager while in use.
- 18)Connect this appliance to properly grounded outlet only. See Grounding Instructions.
- 19)Donot use massager inclose proximity to loose clothing or jewelry.
- 20)Keep long hair away from massager while in use.

SAVE THESE INSTRUCTIONS

GROUNDING INSTRUCTIONS

This product must be grounded ,if it should malfunction or breakdown ,grounding provides a path of least resistance for electric current to reduce the risk of electric shock ,this product is equipped with a cord having an equipment grounding conductor and a grounding plug ,the plug must be plugged into an appropriate outlet that is properly installed and grounded in accordance with all local codes and ordinances

DANGER:Improper connection of the equipment grounding conductor can result in a risk of electric shock ,check with a qualified electrician or serviceman of you are in doubt as to whether the product is properly grounded ,do not modify the plug provided with the product-if it will not fit the outlet,have a proper outlet installed by a qualified electrician

1)This product is for use on nominal 120-volt circuit,and has a grounding plug that looks like the plug illustrated in sketch on the page 16 ,A temporary adapter that looks like the adapter illustrated in sketches B and C may be used to connect this plug to a 2-pole receptacle as shown in sketch B if a properly grounded outlet is not available the temporary adapter should be used only until a properly grounded outlet (shetch A)can be installed by a qualified electrician ,the green colored rigid ear ,lug ,or the like extending from the adapter must be connected to a permanent ground such as a properly grounded outlet box cover ,Whenever the adapter is used ,it must be held in place by a metal screw

INSTRUCTIONS DE SECURITE IMPORTANTES

lors de l'utilisation d'un appareil électrique, des précautions de bases doivent être respectées, y compris ce qui suit :

Lisez toutes les instructions avant d'utiliser l'appareil.

DANGER- Pour réduire le risque de choc électrique:

- 1) Toujours débrancher cet appareil de la prise électrique immédiatement après usage et avant nettoyage

AVERTISSEMENT- Pour réduire le risque de brûlures, d'incendie, de choc électrique ou de blessures:

- 1) Cet appareil ne doit jamais quitter votre surveillance lorsqu'il est branché. Débranchez-le de la prise lorsqu'il est inutilisé, et avant de placer ou d'enlever des pièces.
- 2) Ne pas utiliser cet appareil sous une couverture ou un oreiller. Une chaleur excessive peut provoquer un incendie, un choc électrique ou des blessures corporelles.
- 3) Soyez prudent et maintenez une surveillance accrue lorsque cet appareil est utilisé par, sur, ou près des enfants, de personnes invalides ou handicapées.
- 4) Utilisez l'appareil uniquement pour un usage habituel, comme décrit dans ce manuel. Ne pas utiliser d'accessoires non recommandés par le fabricant.
- 5) Ne jamais faire fonctionner cet appareil si le cordon ou la fiche sont endommagés, s'il ne fonctionne pas correctement, s'il est endommagé ou s'il est tombé dans l'eau. Retournez l'appareil au service technique pour examen et réparation.
- 6) Ne transportez pas cet appareil par le cordon d'alimentation ou d'utilisation comme une poignée.
- 7) Gardez le cordon loin des surfaces chauffées.
- 8) Ne jamais faire fonctionner l'appareil en obstruant les ouvertures d'air. Gardez les ouvertures à l'air, libre de peluches, de cheveux, etc.
- 9) Ne jamais laisser tomber, ou insérer d'objet dans les ouvertures.
- 10) Ne pas utiliser à l'extérieur.
- 11) Ne pas utiliser dans les lieux où des aérosols (vaporisateurs) sont utilisés, ni là où l'oxygène est administré.
- 12) Pour débrancher, mettre tous les boutons de l'appareil sur la position arrêt, puis retirer la fiche de la prise.
- 13) L'appareil est destiné à un usage domestique et à l'intérieur seulement.
- 14) Connectez cet appareil à une prise correctement reliée à la terre. Voir les instructions de mise à la terre.

SECURITE ET ENTRETIEN

- 15) Éloignez les enfants du support de pied ouvert (ou des autres pièces semblables).
- 16) Ne pas utiliser de massage à proximité des vêtements amples ou des bijoux.
- 17) Garder les cheveux longs à l'écart de masseur en cours d'utilisation.
- 18) Raccordez cet appareil à une prise correctement mise à la terre.
- 19) Ne pas utiliser l'appareil de massage à proximité des vêtements amples ou des bijoux.
- 20) Gardez les cheveux longs loin du masseur pendant l'utilisation.

CONSERVER CES INSTRUCTIONS INSTRUCTIONS DE BASES

Ce produit doit être relié à la terre. Si il dysfonctionne ou tombe en panne, la terre fournit un chemin de moindre résistance pour le courant électrique afin de réduire le risque de choc électrique. Cet appareil est équipé d'un cordon avec un conducteur de mise à la terre des équipements et une prise de terre. La fiche doit être branchée dans une prise appropriée qui est correctement installée et mise à la terre conformément à la réglementation locale.

DANGER: un mauvais branchement de l'équipement à la prise de terre, peut entraîner un risque de choc électrique. Consultez un électricien qualifié si vous avez des doutes quant à savoir si le produit est correctement mis à la terre. Ne pas modifier la fiche fournie avec le produit si elle ne rentre pas dans la prise. Adressez vous à un électricien qualifié le cas échéant.

1) Ce produit est destiné à être utilisé sur un circuit de 120 volts, et possède une fiche de mise à la terre semblable à la fiche illustrée sur le croquis de la page 16. Un adaptateur temporaire qui ressemble à l'adaptateur illustré sur le croquis B et C peut être utilisé pour brancher cette fiche à un réceptacle 2-pole, comme indiqué sur le croquis B. Si une prise de terre n'est pas disponible, l'adaptateur temporaire ne doit être utilisé que jusqu'à une prise de terre correcte (croquis A) pour être installé par un électricien qualifié. L'oreille rigide de couleur verte, qui dépasse de l'adaptateur, doit être connectée à une terre permanente comme un couvercle de boîte de sortie mise à la terre. Chaque fois que l'adaptateur est utilisé, il doit être maintenu en place par une vis en métal.

**S'il vous plaît noter que lorsque ne pas coincer votre détection des doigts
Avant le nettoyage ou la réparation doivent couper l'alimentation**

Massage System Installation

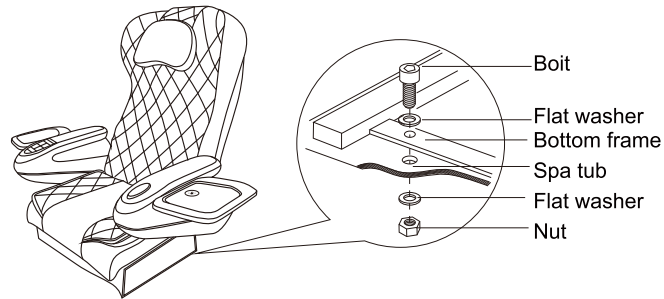

1. select a concrete or wood or chinaware platform with an area more than 40cm*36cm
2. drill four holes on each corner with a diameter 7.8mm
3. locked the massage chair on the platforms

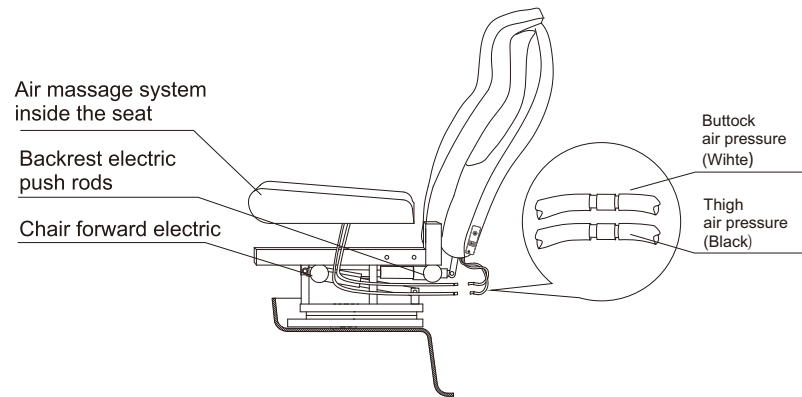

4. Connect black pipe to black pipe, connect white pipe to white pipe.

Name and function of components

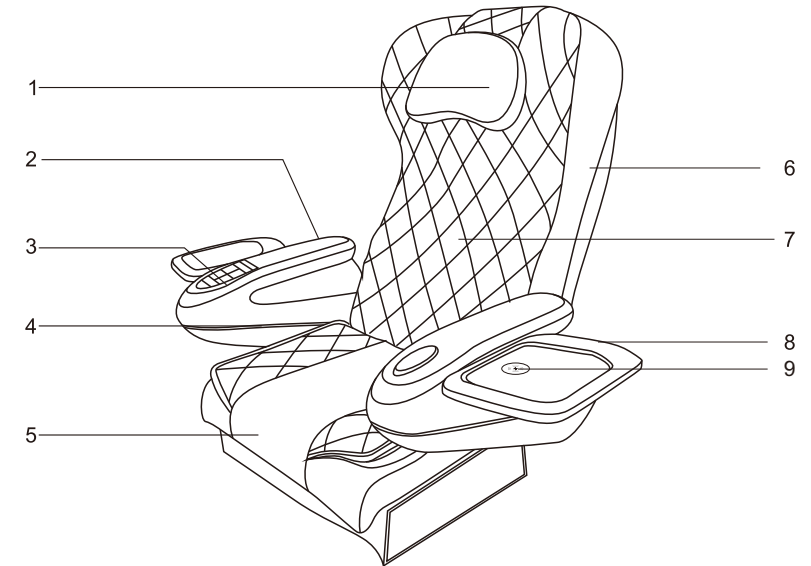

1. Detachable pillow pad
2. USB Charging Port
3. Controller
4. Armrest
5. Detachable seat cushion
6. The back covering
7. Back pad
8. Tray
9. Wireless recharge station

Function

Function

- Designed with a four-wheel driven muted massage mechanism which can move up and down in the backrest.
- Air pressure function: Buttock is equipped with 5 airbags, with 2 modes and 2 strengths.
- Programmed with five kinds of emulational massage functions of Shiatsu, kneading, flapping, knocking and synchronous kneading and flapping.
- Programmed with manual and automatic control modes for the upper body.
- Under the automatic mode, it offers three automatic changed combinations of massage function: lower, upper and full. Under the manual mode, it offers three options of overall, fixed and partial area. Under fixed state, the massage hands can be moved up and down; Each massage function has five levels of speed options; the width between the two massage hands can be adjustable in three levels of wide, middle and narrow when it is under flapping, shiatsu or knocking state.
- Seat frame forward and backward movement, backrest reclining and declining movement.
- Restoring the massage hands after turning off the machine.
- Design with USB charger on right armrest.
- Design with wireless charging function.

Method of usage





Method of usage







1.Controller operate

Button	Adjust massage balls
	To start or stop massage of the upper body































(1)Auto Massage

Button	Adjust massage balls
	To carrying on automatic massage around the neck shoulder mainly
	Carry on automatic massage around in carrying the waist mainly
	Adopt the various tactics to carry on automatic massage to different position of the upper part of the body, the massage position covers the whole upper part of the body.

(2)Upper body manual massage

Button	Function	Display status	Adjust massage balls
	Knead		Speed
	Flap		Speed, Width
	Knock		Speed, Width
	Press		Speed, Width
	Kneading & Flapping		Speed
Massage modes are equipped with 5 strengths.			



Method of usage

Intensity		For speed and massage treatments selection. five intensity options available. the indicators are as follows(black stands for on)	 I  I  I  I  I  II  II  II  II  II  III  III  III  III  III 1 2 3 4 5
Width		Width:when massage treatment of flapping,shiatsu,or knocking has been chosen,press this button to adjust the width of the massage hands,three options,not available under auto kneadingstate.	 I  I  I  II  II  II  III  III  III narrow mid wide
Back Stretching		Upper body(overall) trip massage	
		Small area(partial) trip massage	
		Fixed position (fixed) massage	
Roller Position		When fixed massage has been chosen, press this button to move the massage device downward to suit precise massage points, not available under auto state.	
		When fixed massage has been chosen, press this button to move the massage device upward to suit precise massage points, not available under auto state.	

(3)Other manual function





Timing		Three modes of timing: 10 mins, 20 mins and 30 mins.
--------	--	--

(4)Air mode

Air		Turn on or turn off buttock air pressure massage, 2 modes options available.
Intensity		2 intensity options available.

Method of usage

(5) Adjust angle of backrest and footrest

Seat	 Forward	Press this button continually and the seat frame will move forward, loose your finger and the movement will stop.
	 Backward	Press this button continually and the seat frame will move backward, loose your finger and the movement will stop.
Back	 Back Recline	Press this button continually and the backrest frame will move upward, loose your finger and the movement will stop.
	 Back Up	Press this button continually and the backrest frame will move downward, loose your finger and the movement will stop.

2.Components install direction

- Place the bottom frame of massage chair on the spa tub.
- Make sure the holes of the bottom frame are aligned with the pre-drilled holes on the spa tub.
- Secure the massage chair onto spa tub by using provided hardware as shown in the diagram below.

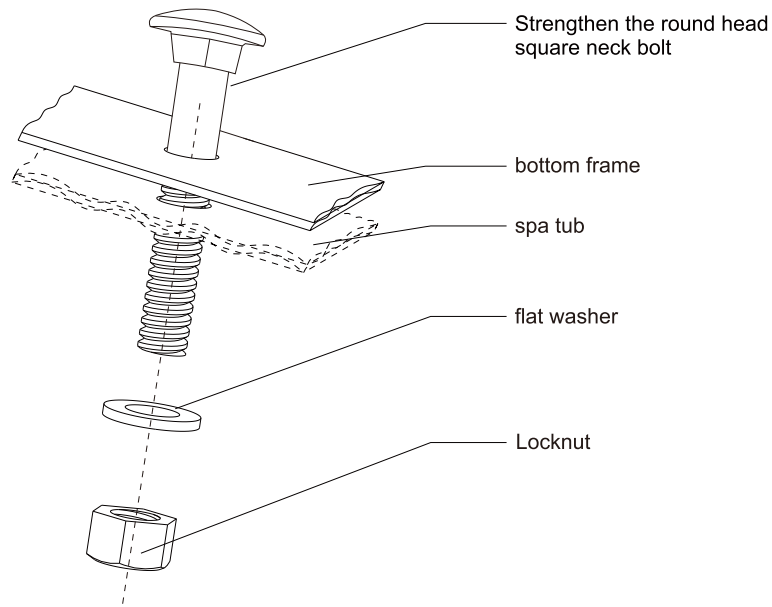

Method of usage

3.Armrest assembling instructions

- 1.Insert the bolt of the handrail connection plate into the positioning hole of the armrest support plate on moving frame.
- 2.Lock corresponding bolt with one M12 I type non-metallic insert locking nut and three M6 I type non-metallic insert locking nut set.

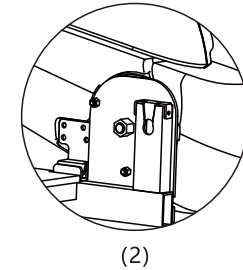
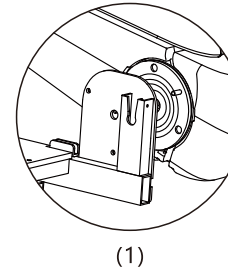

4.Instruction of backrest installation

- Put backrest support shaft into the card slot of backrest support seat. (Note: The shaft can only put into the card slot at certain angle).
- Erect the backrest, the self locking hook will lock the cylinder limit shaft automatically.

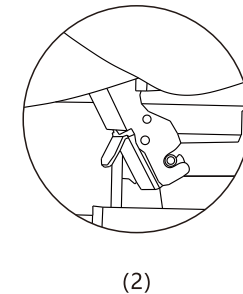
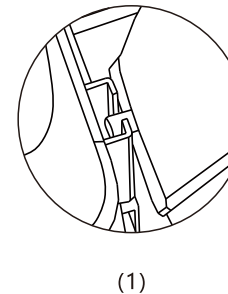

Warning: Before operating the massage, please ensure that the backrest electric cylinder and the pin which fixed backrest connect correctly, and the backrest must be erected before turning on the massage chair. Otherwise, after turned on, the front of electronic cylinder will hit the board under the seat frame, resulting in the seat frame deformation, and even derail or damage the steel ball railway.

Method of usage

5. Operation sequence

SWITCH ON POWER

- (1).insert the plug into the socket outlet.
- (2).switch on the power button behind the armrest.

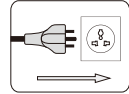

MASSAGE

- (1)Select relative massage according to the operation instructions of the control.

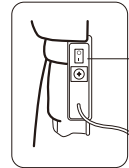

POWER

SWITCH OFF POWER

- (1).stop overall massage.
- (2).switch off the power button behind the armrest.
- (3).pull the plug out of the socket outlet.

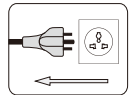

6. Attaching or detaching the pillow pad and back cushion

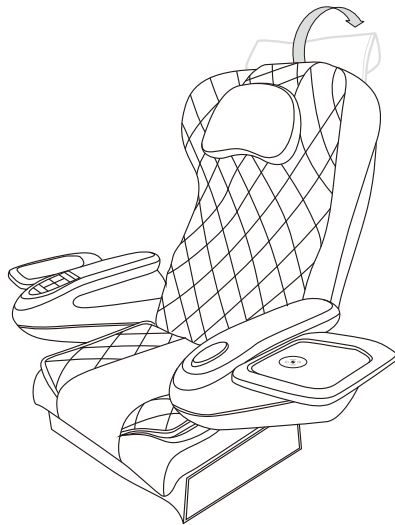

The pillow pad and back cushion (recommended) reduces the kneading intensity of your neck and shoulder, but you can decide to put it on or not according to your personal need.

WARNING : IN CASE OF DANGER, DO NOT REMOVE THE CUSHION



Method of usage

7.To Adjust The Back Simultaneously

Backrest adjustment
press and hold the  button on the controller,the backrest will recline backward slowly. Release the button,then the backrest will be stopped upright
press and hold the  button on the controller,the backrest will move slowly. Loose the button,then the backrest will be stopped .

WARNING: DO NOT EXERT ANY PRESSURE OTHER THAN YOUR OWN BODY ON THE BACK WHILE IT IS RISING.

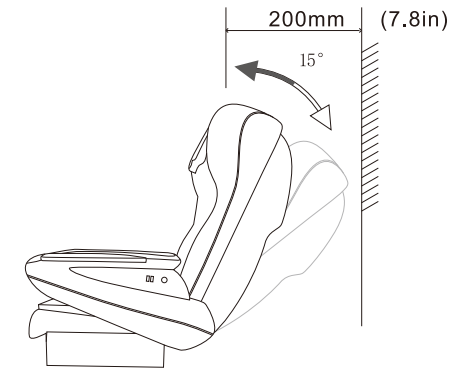

8.To Adjust Seat Frame Separately

The flex fuction of seat frame could fix the different height of the people to adjust the massage place of the calf airbags,the maximum distance moving forward and backward is 120mm.



Method of usage

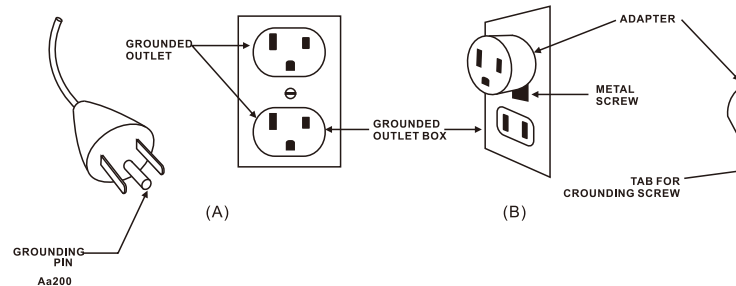

Product specification

Model:9660-6
Name: Massage Chair
Rated Voltage: 120V~ 60Hz 1.1A
Rated Input Power: 70W
Safety Design:Class I

FCC Statement:

This device complies with part 15 of the FCC Rules. Operation is subject to the following

two conditions: (1) This device may not cause harmful interference, and (2) this device

must accept any interference received, including interference that may cause undesired operation.

This equipment has been tested and found to comply with the limits for a Class B digital

device, pursuant to part 15 of the FCC Rules. These limits are designed to provide reasonable protection against harmful interference in a residential installation. This equipment generates, uses and can radiate radio frequency energy and, if not installed and used in accordance with the instructions, may cause harmful interference to radio communications. However, there is no guarantee that interference will not occur in a particular installation. If this equipment does cause harmful interference to radio or television reception, which can be determined by turning the equipment off and on, the

user is encouraged to try to correct the interference by one or more of the following measures:

- Reorient or relocate the receiving antenna.
- Increase the separation between the equipment and receiver.
- Connect the equipment into an outlet on a circuit different from that to which the receiver is connected.
- Consult the dealer or an experienced radio/TV technician for help.

Caution: Any changes or modifications not expressly approved by the party responsible

for compliance could void the user's authority to operate the equipment.

This equipment complies with FCC radiation exposure limits set forth for an uncontrolled environment. This transmitter must not be co-located or operating in conjunction with any other antenna or transmitter.