



FCC TEST REPORT
FCC ID: 2A4VU-G600-8

On Behalf of

iRest Health Science and Technology Co., Ltd.

Spa Massage Chair

**Model No.: G600-8, G509, G530, G510-3, G505-2, G505-5, 9660-X, NS
769, NS 769 VX, G503, G503-X, G505-X, G510-3X**

Prepared for : iRest Health Science and Technology Co., Ltd.
Address : No.468 Shibali East Road, Daqiao Town, Nanhu District, Jiaxing, Zhejiang,
China

Prepared By : Shenzhen Alpha Product Testing Co., Ltd.
Address : Building i, No.2, Lixin Road, Fuyong Street, Bao'an District,
518103, Shenzhen, Guangdong, China

Report Number : A2210146-C01-R01
Date of Receipt : October 21, 2022
Date of Test : October 21, 2022– October 26, 2022
Date of Report : October 26, 2022
Version Number : V0

TABLE OF CONTENTS

Description	Page
1. Test Result Summary	5
2. EUT Description	6
2.1. Description of Device (EUT).....	6
2.2. Accessories of Device (EUT)	8
2.3. Tested Supporting System Details	8
2.4. Block Diagram of Connection between EUT and Simulators.....	8
2.5. Description of Test Modes.....	8
2.6. Test Conditions	8
2.7. Test Facility	9
2.8. Measurement Uncertainty	9
3. Test Results and Measurement Data	10
3.1. RF Exposure Test	10
3.1.1. Test Specification	10
3.1.2. Test Instruments	11
3.1.3. Test data.....	11
4. Photos of test setup	13
5. Photographs of EUT	21

Revision History

Revision	Issue Date	Revisions	Revised By
V0	October 26, 2022	Initial released Issue	Yannis Wen

1. Test Result Summary

Requirement	CFR 47 Section	Result
RF EXPOSURE	§1.1307(b)(1) & KDB680106	PASS

Note:

1. PASS: Test item meets the requirement.
2. Fail: Test item does not meet the requirement.
3. N/A: Test case does not apply to the test object.
4. The test result judgment is decided by the limit of test standard.

2. EUT Description

2.1. Description of Device (EUT)

EUT Name	:	Spa Massage Chair
Model No.	:	G600-8, G509, G530, G510-3, G505-2, G505-5, 9660-X, NS 769, NS 769 VX, G503, G503-X, G505-X, G510-3X
DIFF	:	Only difference is the appearance , and the wireless part has no difference.
Trademark	:	N/A
Power supply	:	AC 120V/60Hz
EUT information	:	Wireless Output: 5W
Operation frequency	:	110~205KHz
Modulation	:	MSK
Antenna Type	:	Coil Antenna, Maximum Gain is 0dBi (This value is supplied by applicant).
Software version	:	V1.0
Hardware version	:	V1.0
Connector cable loss	:	0.5dB (This value is supplied by applicant).
Intend use environment	:	Residential, commercial and light industrial environment

The EUT does comply with section 5 b) of KDB 680106 D01 RF Exposure Wireless charging App V03r01.

Conditions requirement	Answers
Power transfer frequency is less than 1 MHz.	After measuring the product the transfer frequency is 0.110-0.205MHz
Output power from each primary coil is less than or equal to 15 watts.	After measuring the product the each primary coil power is 5 watts
The system may consist of more than one source primary coils, charging one or more clients. If more than one primary coil is present, the coil pairs may be powered on at the same time.	The transfer system includes one primary.
Client device is placed directly in contact with the transmitter.	Client device is placed directly in contact with the transmitter.
Mobile exposure conditions only (portable exposure conditions are not covered by this exclusion).	Mobile exposure conditions only.
The aggregate H-field strengths at 15 cm surrounding the device and 20 cm above the top surface from all simultaneous transmitting coils are demonstrated to be less than 50% of the MPE limit.	After measuring the product the Max H-field Strength is 0.802A/m Far less than 50% of the MPE limit.

2.2. Accessories of Device (EUT)

Accessories1 : /
 Manufacturer : /
 Model : /
 Ratings : /

2.3. Tested Supporting System Details

No.	Description	Manufacturer	Model	Serial Number	Certification
1	Wireless load	--	--	--	--

2.4. Block Diagram of Connection between EUT and Simulators

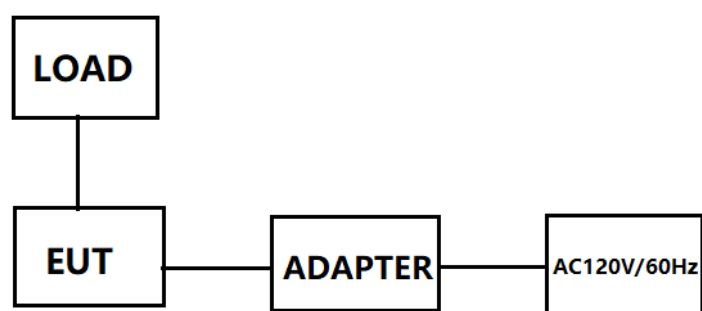

2.5. Description of Test Modes

Channel	Frequency (KHz)
1	128

2.6. Test Conditions

Items	Required	Actual
Temperature range:	15-35°C	24°C
Humidity range:	25-75%	56%
Pressure range:	86-106kPa	98kPa

2.7. Test Facility

Shenzhen Alpha Product Testing Co., Ltd

Building i, No.2, Lixin Road, Fuyong Street, Bao'an District, 518103, Shenzhen, Guangdong, China

June 21, 2018 File on Federal Communication Commission

Registration Number: 293961

July 15, 2019 Certificated by IC

Registration Number: CN0085

2.8. Measurement Uncertainty

(95% confidence levels, k=2)

Item	Uncertainty
Uncertainty for H-Field	2.39dB
Uncertainty for E-Field	2.45dB
Uncertainty for conducted RF Power	0.65dB
Uncertainty for temperature	0.2°C
Uncertainty for humidity	1%
Uncertainty for DC and low frequency voltages	0.06%

3. Test Results and Measurement Data

3.1. RF Exposure Test

3.1.1. Test Specification

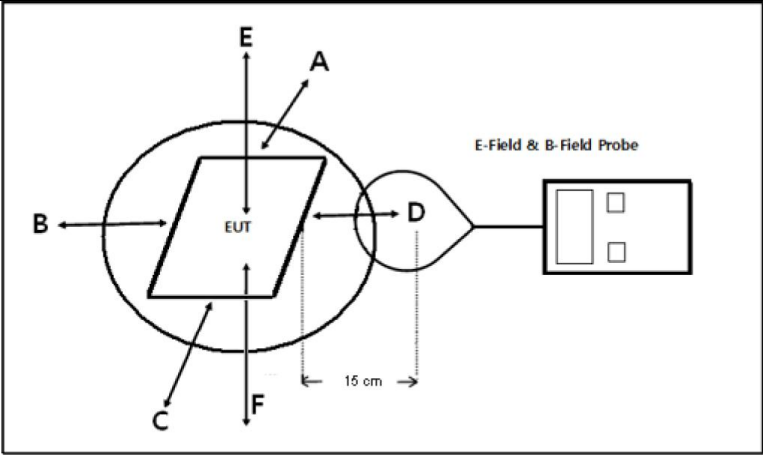
Test Requirement:	FCC Rules and Regulations KDB680106
Test Method:	§1.1307(b)(1) & KDB680106
Limits:	According to §1.1307(b)(1), systems operating under the provisions of this section shall be operated in a manner that ensures that the public is not exposed to radio frequency energy level in excess of the Commission's guidelines. According to §1.1310 and §2.1093 RF exposure is calculated. According KDB680106 D01v03r01: RF Exposure Wireless Charging.
Test Setup:	
Test Mode:	Wireless charging load has been charge at no load, middle load and full load. All test modes were pre-tested, but we only recorded the worse case in this report.
Test Procedure:	<ol style="list-style-type: none"> 1. The RF exposure test was performed in shielded chamber 2. The measurement probe was placed at test distance(15cm) which is between the edge of the charger and the geometric centre of probe. 3. The measurement probe used to search of highest strength. 4. The highest emission level was recorded and compared with limit as soon as measurement of each points (A,B,C,D,E,F) were completed. 5. The EUT were measured according to the dictates of KDB 680106 DR03-44118.
Test Result:	PASS

3.1.2. Test Instruments

Item	Equipment	Manufacturer	Model No.	Firmware version	Serial No.	Last Cal.	Cal. Due day
1	Exposure Level Tester	narda	ELT-400	/	N-0231	2022.08.30	2022.08.30
2	Magnetic field probe 100cm2	narda	ELT probe 100cm2	/	M0675	2022.08.30	2023.08.29
3	Isotropic Electric Field Probe	narda	EP-601	/	511WX60706	2022.08.30	2023.08.29

3.1.3. Test data

For Full load mode:

E-Field Strength at 15 cm for position A,B,C,D 20cm for position E from the edges surrounding the EUT (V/m)

Frequency Range (MHz)	Test Position A	Test Position B	Test Position C	Test Position D	Test Position E	Limit (50%) (V/m)	Limits Test (V/m)
0.110-0.205	1.233	1.102	1.220	1.253	1.147	307	614

H-Filed Strength at 15 cm for position A,B,C,D 20cm for position E from the edges surrounding the EUT (A/m)

Frequency Range (MHz)	Test Position A	Test Position B	Test Position C	Test Position D	Test Position E	Limit (50%) (A/m)	Limits Test (A/m)
0.110-0.205	0.792	0.772	0.710	0.748	0.802	0.815	1.63

E-Field Strength at 0cm for position C,E from the edges surrounding the EUT (V/m)

Frequency Range (MHz)	Test Position A	Test Position B	Test Position C	Test Position D	Test Position E	Limit (50%) (V/m)	Limits Test (V/m)
0.110-0.205	/	/	1.736	/	1.538	307	614

H-Filed Strength at 0cm for position C,E from the edges surrounding the EUT (A/m)

Frequency Range (MHz)	Test Position A	Test Position B	Test Position C	Test Position D	Test Position E	Limit (50%) (A/m)	Limits Test (A/m)
0.110-0.205	/	/	0.814	/	0.793	0.815	1.63

For Null load mode:

E-Field Strength at 15 cm for position A,B,C,D 20cm for position E from the edges surrounding the EUT (V/m)

Frequency Range (MHz)	Test Position A	Test Position B	Test Position C	Test Position D	Test Position E	Limit (50%) (V/m)	Limits Test (V/m)
0.110-0.205	1.244	1.103	1.236	1.276	1.150	307	614

H-Filed Strength at 15 cm for position A,B,C,D 20cm for position E from the edges surrounding the EUT (A/m)

Frequency Range (MHz)	Test Position A	Test Position B	Test Position C	Test Position D	Test Position E	Limit (50%) (A/m)	Limits Test (A/m)
0.110-0.205	0.587	0.576	0.655	0.641	0.626	0.815	1.63

E-Field Strength at 0cm for position C,E from the edges surrounding the EUT (V/m)

Frequency Range (MHz)	Test Position A	Test Position B	Test Position C	Test Position D	Test Position E	Limit (50%) (V/m)	Limits Test (V/m)
0.110-0.205	/	/	1.278	/	1.237	307	614

H-Filed Strength at 0cm for position C,E from the edges surrounding the EUT (A/m)

Frequency Range (MHz)	Test Position A	Test Position B	Test Position C	Test Position D	Test Position E	Limit (50%) (A/m)	Limits Test (A/m)
0.110-0.205	/	/	0.703	/	0.769	0.815	1.63

4. Photos of test setup

For Full load mode(10cm)

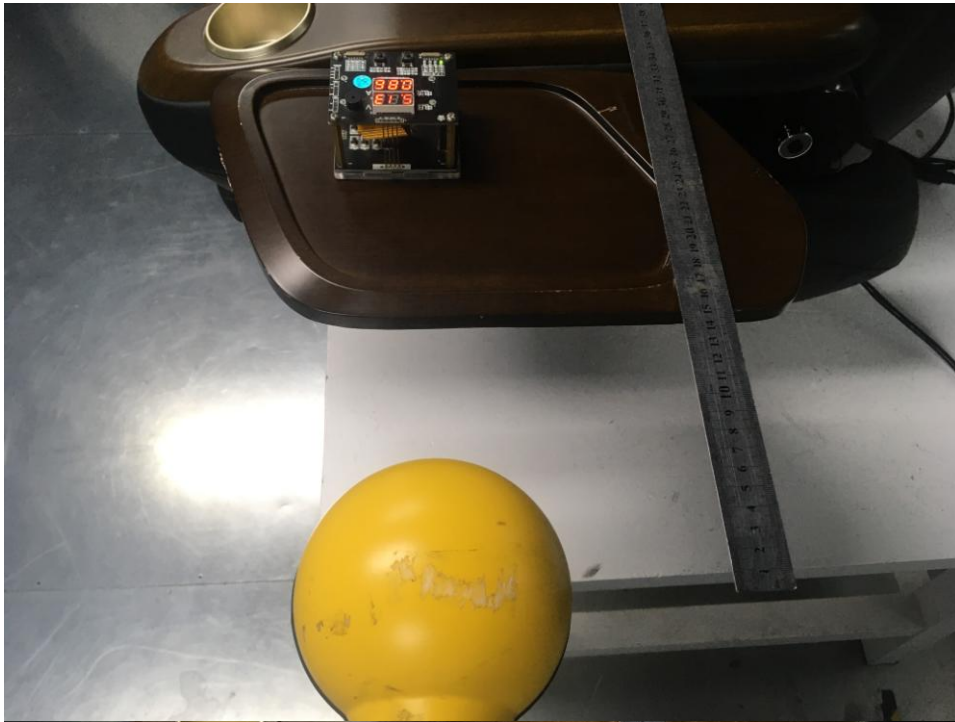

A

For Full load mode(10cm)



B

For Full load mode(10cm)



C

For Full load mode(10cm)

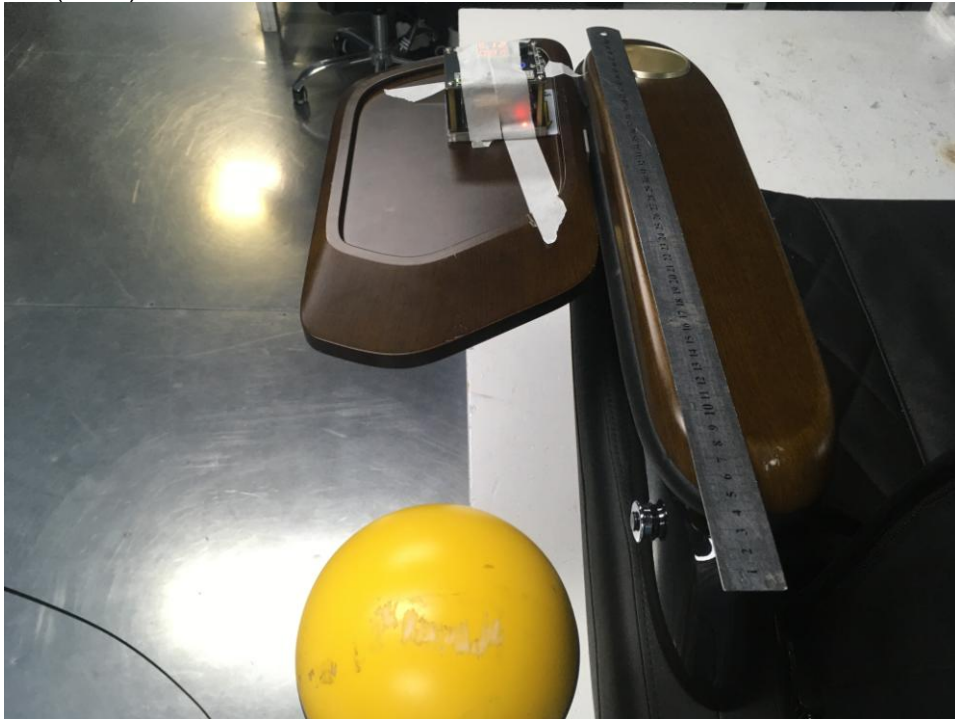

D

For Full load mode(10cm)

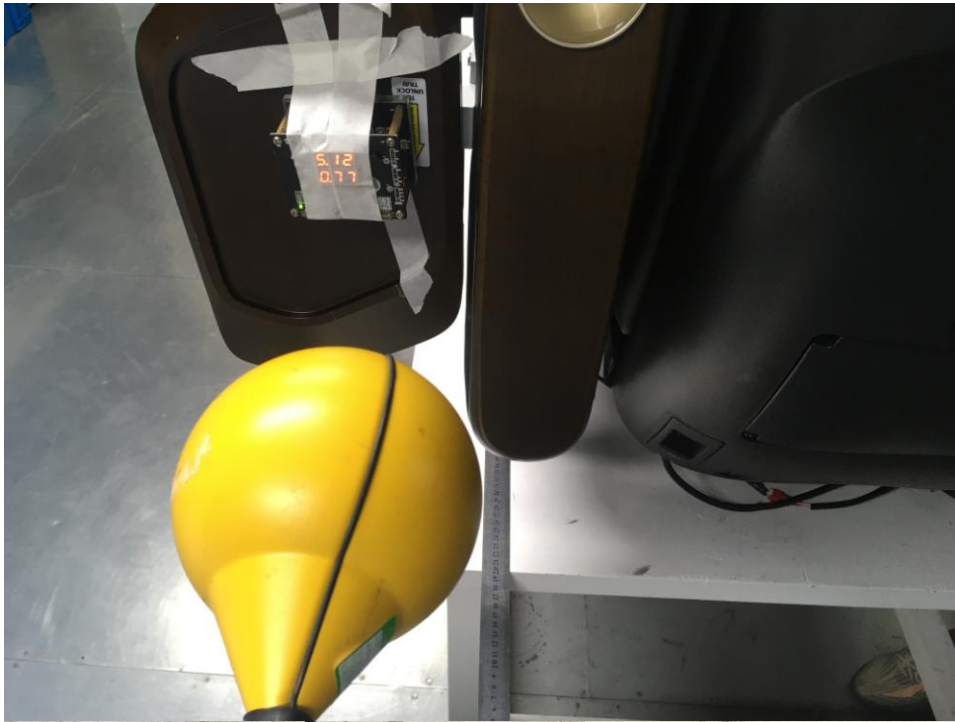

E

For Full load mode(0cm)



C

For Full load mode(0cm)



E

For Full load mode(10cm)

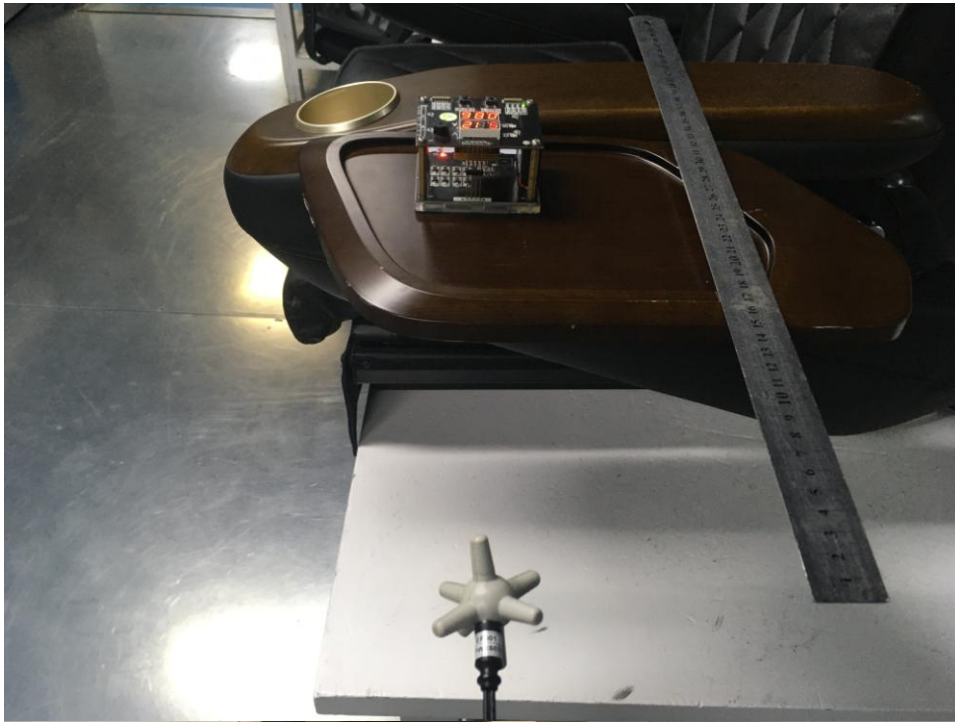

A

For Full load mode(10cm)



B

For Full load mode(10cm)

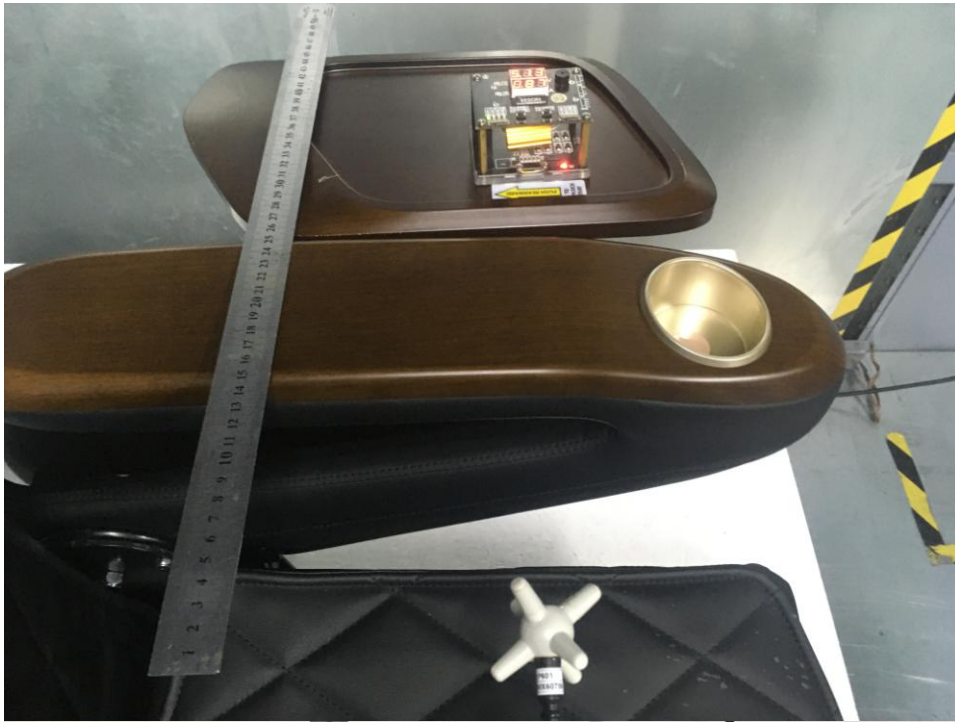

C

For Full load mode(10cm)



D

For Full load mode(10cm)

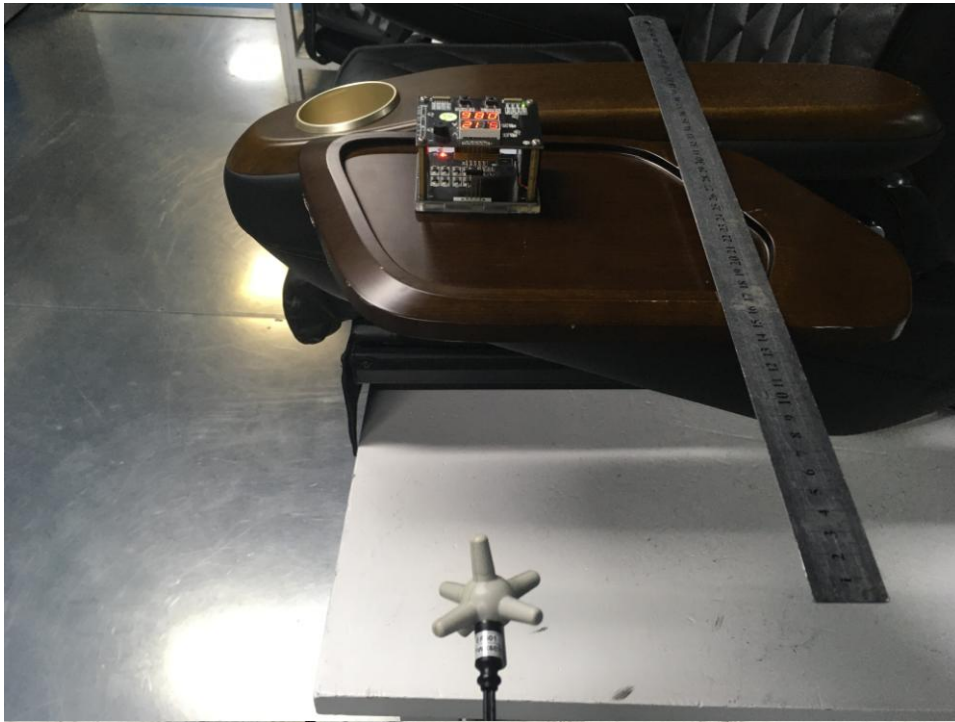

E

For Full load mode(0cm)

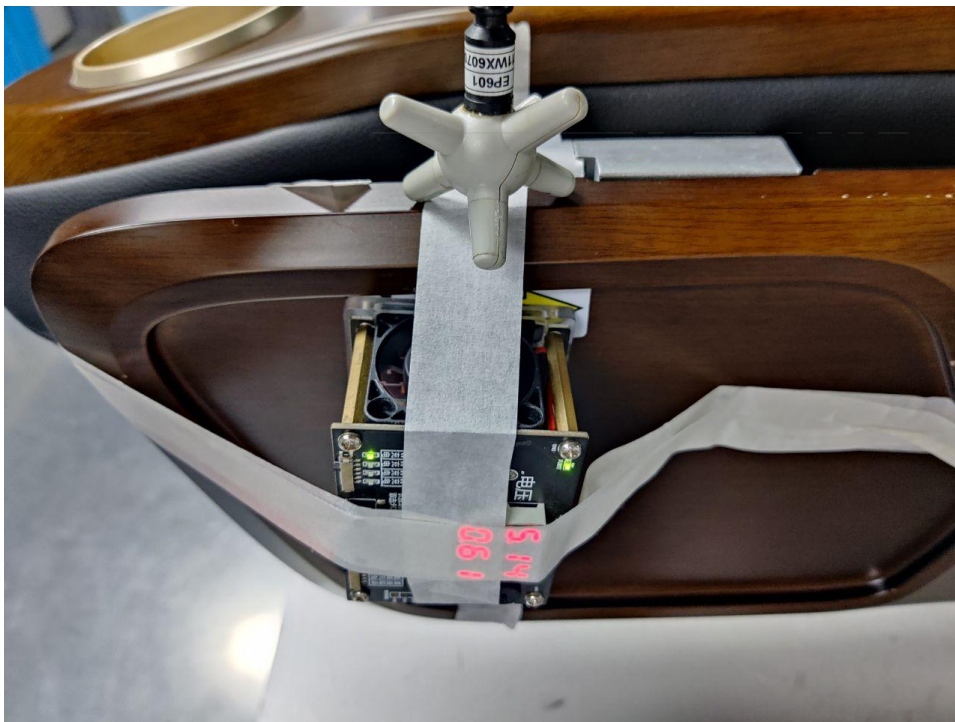

C

For Full load mode(0cm)

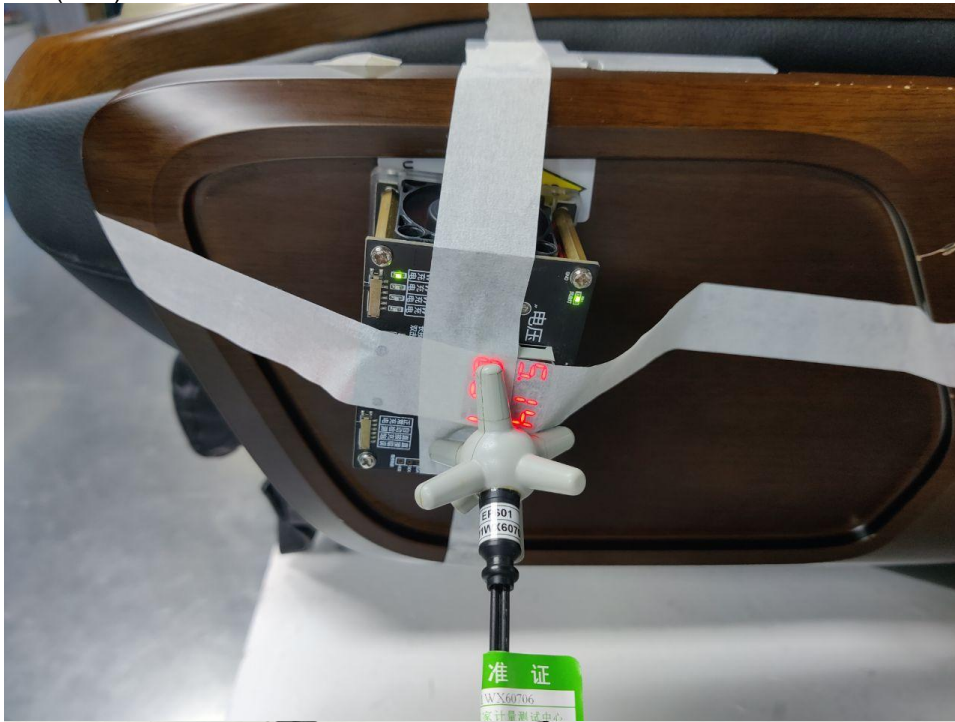

E

5. Photographs of EUT

Refer to ANNEX.

-----END OF REPORT-----