

**G270 SPA Massage Chair**  
**Operation Instructions**

**SAVE THESE INSTRUCTIONS**

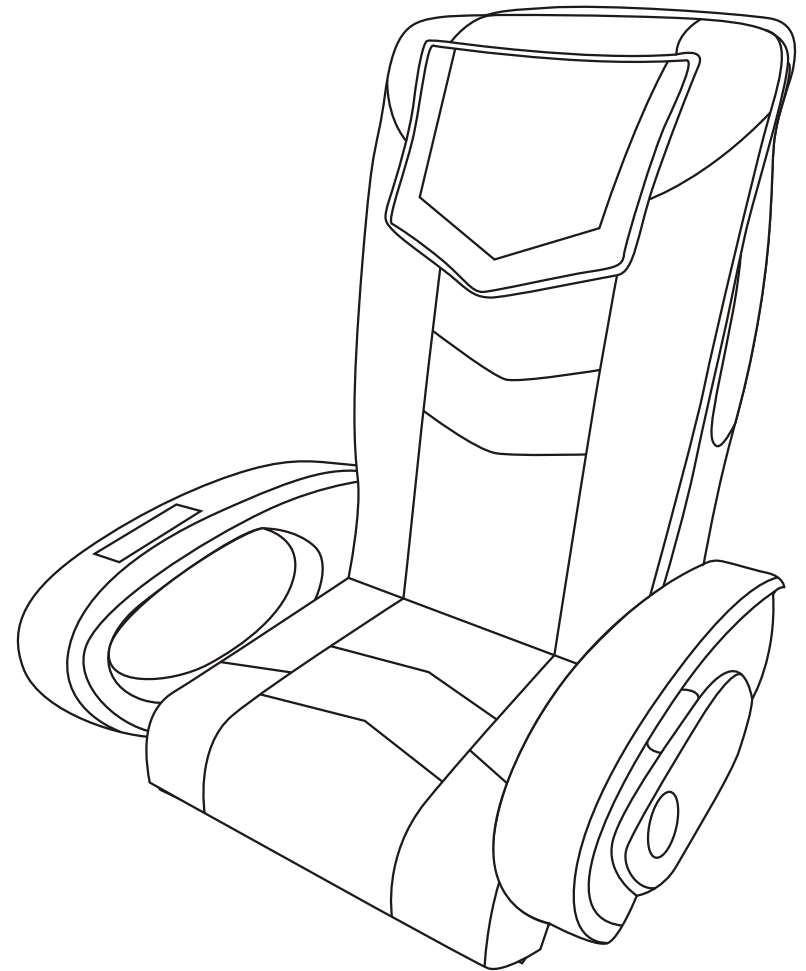

Thanks for purchasing this product. Please read this manual instruction carefully in order to know how to use this product correctly before operation. Please pay more attention to some important safety warning and keep this manual book properly for future use.

Note: Our Company reserves the right to revise the design and description of this product without any further notice. Please refer to the actual color of this product.

## CONTENTS

---

|                                 |    |
|---------------------------------|----|
| Important Safety Warning        | 02 |
| Name and function of components | 04 |
| Function                        | 05 |
| Method of usage                 | 06 |
| Product specification           | 13 |

# IMPORTANT SAFETY WARNING

## 1. IMPORTANT SAFETY WARNING.



- Don't allow children to touch moveable part of this product.
- Please use well-grounding power supply suited to this product.
- Please pull out the plug after use or before cleaning to avoid injury or Damage to the product.
- Please operate this product according to this manual instruction.
- Don't use accessories which are not recommended.
- Don't use this product outdoors.
- Please read this manual instruction carefully before operation.
- Any other usage that is not listed in this manual instruction is forbidden.
- 20 minutes of usage each time is recommended.
- Please don't use it if the leather is broken or damaged.
- Please don't use it if the cover or leather is damaged.
- Please don't use it if the radiator hole is covered or blocked.
- Please don't drop anything into this product.
- Please don't fall asleep while using this product.
- Please don't use it if drunk or feel unwell.
- Please don't use it within one hour after having meal.
- Please don't make the massage function too strong for avoiding Injury.

## 2. Environment for usage.

- Please don't use it under high temperature and moist environment such as bathroom.
- Please don't use it immediately while the environmental temperature changes sharply.
- Please don't use it under heavy-dusty or caustic environment.
- Please don't use it where there is not enough space or not good ventilation.

## 3. People who are not suitable to use this product.

- People who are suffering from osteoporosis are not suitable to use this product.
- People who are suffering from heart disease or carrying electronic medical equipment such as heart pacemaker are not suitable to use this product.
- People who are suffering from fever are not suitable to use this product.
- Pregnant women or women that are in menses period are not suitable to use this product.
- People who got injured or skin disease are not suitable to use this product.
- Children under 14-year old or people mentally unbalanced without being Supervised are not allowed to use this machine.
- People who are told by doctor to have rest or people who feel unwell are not suitable to use this product.
- People whose bodies are wet are forbidden to use this product.

## 4. Safety.

- Check the voltage if it is suitable to the specification of this product.
- Don't use wet hand to pull the plug.
- Don't make water go inside this product to avoid electric shock or cause damage to this product.

# Safety and maintenance

- Don't damage the wires or change the circuit of this product.
- Don't use wet cloth to clean the electric parts such as switch and plug.
- Be away from this product under power cut state to avoid injury if the power comeback suddenly.
- Stop using this product while it works abnormal, and please consult local agent immediately.
- Stop using this product if you feel unwell, and please consult health care doctor.
- This appliance is not intended for use by persons (including children) with reduced physical, sensory or mental capabilities, or lack of experience and knowledge, unless they have been given supervision or instruction concerning use of the appliance by a person responsible for their safety.
- Children should be supervised to ensure that they do not play with the Appliance.
- If the supply cord is damaged, it must be replaced by the manufacturer, its Service agent or similarly qualified persons in order to avoid a hazard.

## 5. Maintenance.

- This product should be maintained by certain appointed agents, users are prohibited to disassemble or maintain by themselves.
- Please don't forget to cut the power after usage.
- Don't use this product if the socket looses.
- If this product will be left unused for long, please curl up the wires and reserve this product in dry and dustless environment.
- Don't reserve this product under high temperature or near fire and avoid longtime direct sunshine.
- If the detachable cord / supply cord is damaged, it must be replaced by the manufacturer, its service agent or similarly qualified persons in order to avoid a Hazard.
- Please clean this product by dry cloth. Don't use thinner, benzene or alcohol.
- The mechanical components of this product are specially designed and made, it is not necessary to be specially maintained.
- Don't use edged res to thrust this product.
- Don't roll or pull this product above uneven ground, it should be lifted before moving.
- Please use it intermittently; don't make this product work continuously for long.

## 6. Solution of ordinary malfunctions.

- It is nature movement voice if the motor sounds while in usage.
- If the controller can't work normally, please check the plug and socket if they are connected strongly and make sure the switch is turned on.
- If the rated working time is over, the product will automatically activate the power-off button; If this product works continuously for long, the temperature protector will make the product automatically power-off, it should be used again after half an hour's rest.

## Name and function of components

---

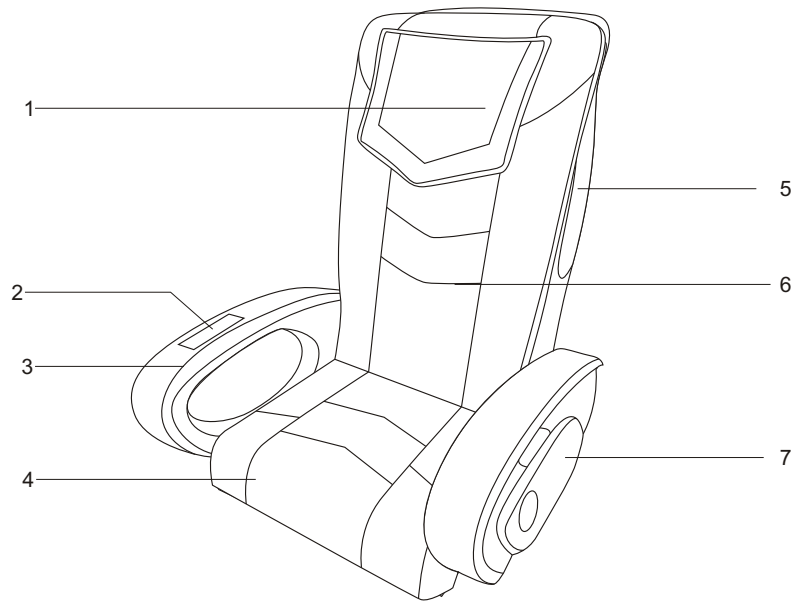

1. Detachable pillow pad
2. Controller
3. Armrest
4. Detachable seat cushion
5. The back covering
6. Back pad
7. Tray

## Function

---

### Function

- Designed with a four-wheel driven muted massage mechanism which can move up and down in the backrest.
- Programmed with five kinds of emulational massage functions of Shiatsu, kneading, flapping, knocking and synchronous kneading and flapping.
- Programmed with manual and automatic control modes for the upper body.
- Under the automatic mode, it offers three automatic changed combinations of massage function: lower, upper and full. Under the manual mode, it offers three options of overall, fixed and partial area. Under fixed state, the massage hands can be moved up and down; Each massage function has five levels of speed options; the width between the two massage hands can be adjustable in three levels of wide, middle and narrow when it is under flapping, shiatsu or knocking state.
- Seat frame forward and backward movement, backrest reclining and declining movement.
- Restoring the massage hands after turning off the machine.

## Method of usage



## Method of usage



























### 1.Controller operate

| Button  |  | Adjust massage balls                       |
|---|--|--|
|  |  | To start or stop massage of the upper body |







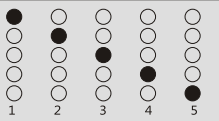

### (1)Auto Massage

| Button  | Function             | Adjust massage balls   | Display status |
|---|----------------------|--|----------------|
|  | <b>UPPER BODY</b>    | Adopt the various tactics to carry on automatic massage to different position of the upper part of the body, the massage position covers the whole upper part of the body. | A1             |
|   | <b>NECK SHOULDER</b> | To carrying on automatic massage around the neck shoulder mainly   | A2             |
|   | <b>BACK WAIST</b>    | Carry on automatic massage around in carrying the waist mainly   | A3             |

### (2)Upper body manual massage

| Button  | Function            | Display status  | Adjust massage balls |
|---|---------------------|---|----------------------|
|  | Knead               |           | Speed                |
|   | Tap                 |      | Speed, Width         |
|   | Kneading & Flapping |      | Speed                |
|   | Knock               |      | Speed, Width         |
|   | Shiatsu             |      | Speed, Width         |





## Method of usage

|   |   |  |
|---|---|--|
|  | For speed and massage treatments sel-ection.five speed options available. the indicators are as follows(black stands for on).   |  |
|  | Width: when massage treatment of flap-ping,shiatsu,or knocking has been chosen, press this button to adjust the width of the massage hands, three options, not available under auto kneading state. |   |
|  | Upper body(overall) trip massage  |   |
|   | Small area(partial) trip massage  |   |
|   | Fixed position (fixed) massage  |   |
|  | When fixed massage has been chosen, press this button to move the massage device downward to suit precise massage points, not available under auto state.   |  |
|   | When fixed massage has been chosen, press this button to move the massage device upward to suit precise massage points, not available under auto state.   |  |

### (3)Other manual function

|        |   |  |
|--------|---|--|
| Timing |  | Three modes of timing: 10 mins, 20 mins and 30 mins. |
|--------|---|--|

### (4)Adjust angle of backrest andfootrest

|      |   |  |
|------|---|--|
| Seat |  | Press this button continually and the seat frame will move forward, loose your finger and the movement will stop.      |
|      |  | Press this button continually and the seat frame will move backward, loose your finger and the movement will stop.     |
| Back |  | Press this button continually and the backrest frame will move upward, loose your finger and the movement will stop.   |
|      |  | Press this button continually and the backrest frame will move downward, loose your finger and the movement will stop. |

## Method of usage

### 2.Components install direction

- Place the bottom frame of massage chair on the spa tub.
- Make sure the holes of the bottom frame are aligned with the pre-drilled holes on the spa tub.
- Secure the massage chair onto spa tub by using provided hardware as shown in the diagram below.

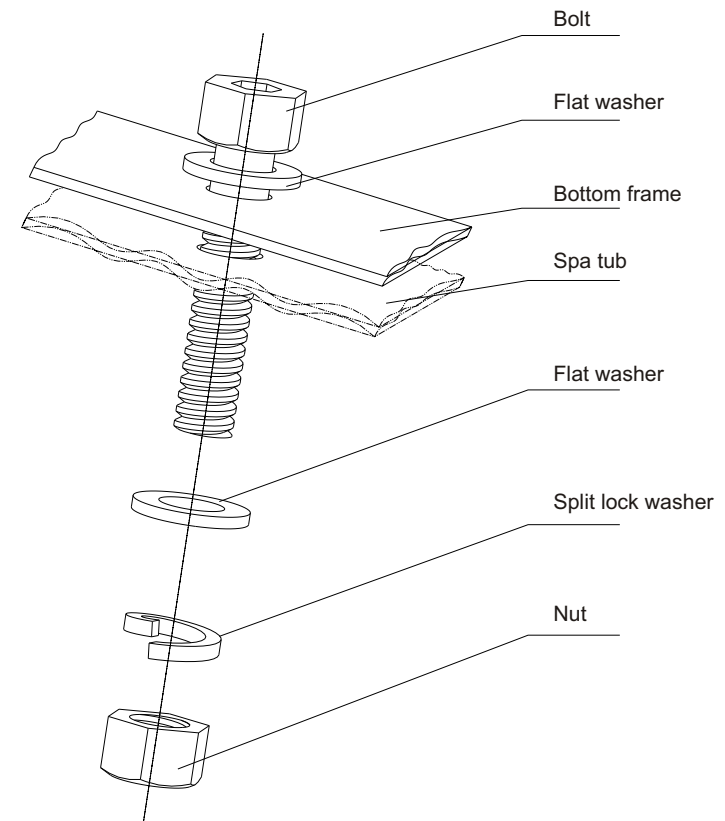

## Method of usage

### 3.armrest assembling instructions

- (1).Insert the armrest spindle into the armrest installation shaft sleeve (note :the direction of the spindle screw via hole and shaft sleeve screw via hole should be same )
- (2).Insert the inner hexagonal-headed bolt M6 into the screw hole and screw tightly.
- (3).Screw tightly the spindle from the other side of the armrest installation seat with hexagon-headed bolt M10、 spring washer and flat washer

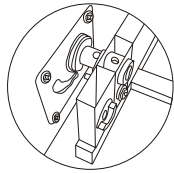

(1)

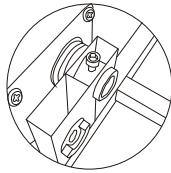

(2)

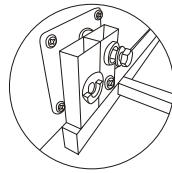

(3)

### 4.Instruction of backrest installation

- (1).Insert the backrest frame into the half slot of backrest installation seat .
- (2).Insert the hexagonal-headed bolt M10 into the backrest installation seat from the outside .

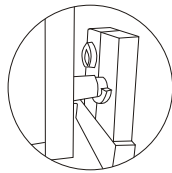

(1)

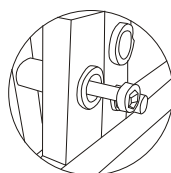

(2)

- (3).Put the installation hole of the electro-motional rod in the backrest in order with the seat hole of the electro-motional rod in the backrest.and then insert the peg

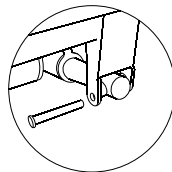

(3)

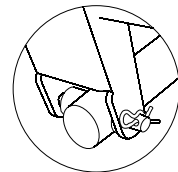

## Method of usage

### Caution:

- (1). The correct method of operation: before operating the controller, please make sure that the backrest electronic cylinder is connected well with the pin that fixes the backrest.
- (2). When the backrest electric cylinder is not connected with the pin that fixes the backrest, please hold the electronic cylinder in case it touches the ground when operate the controller.
- (3). When debugging and installation, before operating the controller, please make sure that the backrest electric cylinder is connected well with the pin that fixes the backrest. Otherwise, after shutting down the switch, the front part of the electronic cylinder will hit the board under the seat frame to cause bad distortion of the seat frame, and even make the rail go out of the railway or damage the steel-ball railway.

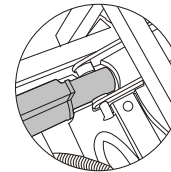

(1)

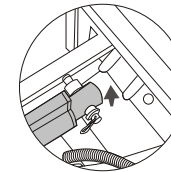

(2)

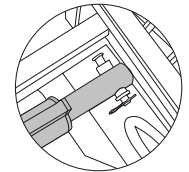

(3)

### 5.Operation sequence

#### SWITCH ON POWER

- (1).insert the plug into the socket outlet.
- (2).switch on the power button behind the armrest.

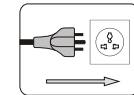

#### MASSAGE

- (1)Select relative massage according to the operation instructions of the control.

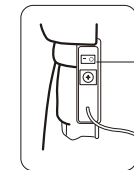

POWER

#### SWITCH OFF POWER

- (1).stop overall massage.
- (2).switch off the power button behind the armrest.
- (3).pull the plug out of the socket outlet.

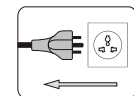

## Method of usage

---

### 6. Attaching or detaching the pillow pad and back cushion

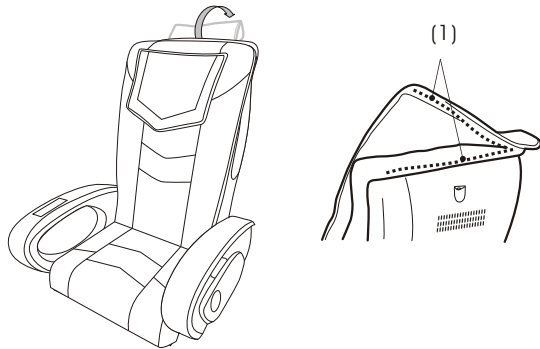

The pillow pad and back cushion (recommended) reduces the kneading intensity of your neck and shoulder, but you can decide to put it on or not according to your personal need. (1) Sticker connects the pillow pad and back cushion.

WARNING : IN CASE OF DANGER, DO NOT REMOVE THE CUSHION



### 7. To Adjust The Back Simultaneously

Backrest adjustment

press and hold the  button on the controller, the backrest will recline backward slowly. Release the button, then the backrest will be stopped upright  
press and hold the  button on the controller, the backrest will move slowly. Loose the button, then the backrest will be stopped.

WARNING: DO NOT EXERT ANY PRESSURE OTHER THAN YOUR OWN BODY ON THE BACK WHILE IT IS RISING.

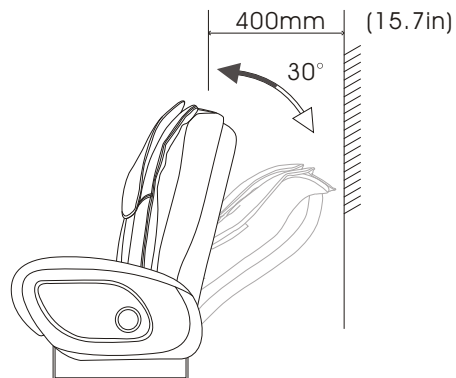

## Method of usage

---

### 8. To Adjust Seat Frame Separately

The flex function of seat frame could fix the different height of the people to adjust the massage place of the calf airbags, the maximum distance moving forward and backward is 120mm.

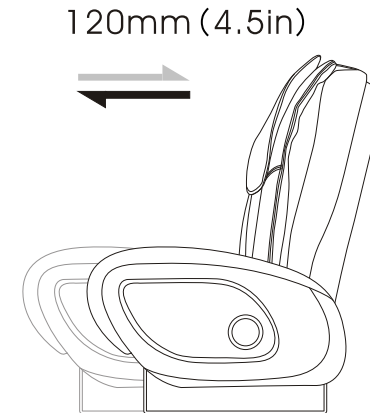

## Product specification

---

Model: G270

Name: SPA Massage Chair

Power supply: 110-120V~ 60Hz   
220-240V~ 50Hz/60Hz

Rated power: 160W

Safety structure: Class I



FCC Statement:

This device complies with part 15 of the FCC Rules. Operation is subject to the following two conditions:

- (1) This device may not cause harmful interference, and
- (2) this device

must accept any interference received, including interference that may cause undesired operation.

This equipment has been tested and found to comply with the limits for a Class B digital device, pursuant to part 15 of the FCC Rules. These limits are designed to provide reasonable protection against harmful interference in a residential installation. This equipment generates, uses and can radiate radio frequency energy and, if not installed and used in accordance with the instructions, may cause harmful interference to radio communications. However, there is no guarantee that interference will not occur in a particular installation. If this equipment does cause harmful interference to radio or television reception, which can be determined by turning the equipment off and on, the user is encouraged to try to correct the interference by one or more of the following measures:

- Reorient or relocate the receiving antenna.
- Increase the separation between the equipment and receiver.
- Connect the equipment into an outlet on a circuit different from that to which the receiver is connected.
- Consult the dealer or an experienced radio/TV technician for help.

Caution: Any changes or modifications not expressly approved by the party responsible for compliance could void the user's authority to operate the equipment.

This equipment complies with FCC radiation exposure limits set forth for an uncontrolled environment. This transmitter must not be co-located or operating in conjunction with any other antenna or transmitter.