



FCC Test Report

Report No: FCS202201084W01

Issued for

Applicant:	Dongguan Lianyou Intelligent Technology Co., Ltd.
Address:	6th Floor, Building A, Guanshen Technology Park, Shangxiawei Industrial Road, Zhutang, Fenggang Town, Dongguan City
Product Name:	Smart curtain robot
Brand Name:	N/A
Model Name:	LY1678
Series Model:	N/A
FCC ID:	2A4VM-LY1678
<p>Issued By: Flux Compliance Service Laboratory Add: Room 105 Floor Bao hao Technology Building 1 NO.15 Gong ye West Road Hi-Tech Industrial, Song shan lake Dongguan Tel: 769-27280901 Fax:769-27280901 http://www.FCS-lab.com</p>	

TEST RESULT CERTIFICATION

Applicant's Name.....: Dongguan Lianyou Intelligent Technology Co., Ltd.
Address.....: 6th Floor, Building A, Guanshen Technology Park, Shangxiawei Industrial Road, Zhutang, Fenggang Town, Dongguan City
Manufacture's Name.....: Dongguan Lianyou Intelligent Technology Co., Ltd.
Address.....: 6th Floor, Building A, Guanshen Technology Park, Shangxiawei Industrial Road, Zhutang, Fenggang Town, Dongguan City

Product Description

Product Name.....: Smart curtain robot
Brand Name: N/A
Model Name.....: LY1678
Series Model.....: N/A
Test Standards.....: FCC Rules and Regulations Part 15 Subpart C, Section 231
Test Procedure.....: ANSI C63.10:2013

This device described above has been tested FCS, the test results show that the equipment under test (EUT) is in compliance with the FCC requirements. And it is applicable only to the tested sample identified in the report.

This report shall not be reproduced except in full, without the written approval of FCS, this document may be altered or revised by FCS, personal only, and shall be noted in the revision of the document..

Date of Test.....:

Date (s) of performance of tests.: 08 Feb. 2022 ~ 16 Feb. 2022

Date of Issue.....: 16 Feb. 2022

Test Result.....: Pass

Tested by : _____

Scott Shen

(Scott Shen)

Reviewed by : _____

Duke Qian

(Duke Qian)

Approved by : _____

Jack Wang

(Jack Wang)

Table of Contents	Page
1. SUMMARY OF TEST RESULTS.....	5
1.1 TEST FACTORY.....	6
1.2 MEASUREMENT UNCERTAINTY.....	6
2. GENERAL INFORMATION.....	7
2.1 GENERAL DESCRIPTION OF THE EUT.....	7
2.2 DESCRIPTION OF THE TEST MODES.....	7
2.3 DESCRIPTION OF NECESSARY ACCESSORIES AND SUPPORT UNITS.....	9
2.4 EQUIPMENTS LIST.....	10
3. RADIATED EMISSION MEASUREMENT.....	11
3.1 LIMIT.....	15
3.2 TEST PROCEDURE.....	16
3.3 TEST SETUP.....	17
3.4 TEST RESULTS.....	18
4. TRANSMITTER TIME.....	22
4.1 LIMIT.....	22
4.2 TEST PROCEDURE.....	22
4.3 TEST SETUP.....	22
4.4 TEST RESULTS.....	22
5. 20 DB BANDWIDTH TEST.....	24
5.1 LIMIT.....	24
5.2 TEST PROCEDURE.....	24
5.3 TEST SETUP.....	24
5.4 TEST RESULTS.....	25
6. DUTY CYCLE.....	26
6.1 LIMIT.....	26
6.2 TEST PROCEDURE.....	26
6.3 TEST SETUP.....	26
6.4 TEST RESULTS.....	27
7 ANTENNA REQUIREMENT.....	29
7.1 STANDARD REQUIREMENT.....	29
7.2 EUT ANTENNA.....	29

Revision History

Rev.	Issue Date	Effect Page	Contents
00	16 Feb. 2022	All	Initial Issue

1. SUMMARY OF TEST RESULTS

FCC Part 15.231,Subpart C			
Standard Section	Test Item	Judgment	Remark
15.207	Conducted Emission	N/A	--
15.209, 15.231(b)	Radiated Emission	PASS	--
15.231(a) (1)	Transmitter time	PASS	--
15.231(c)	20dB Bandwidth	PASS	
15.231	Duty cycle	PASS	--
15.203	Antenna Requirement	PASS	--

NOTE:

(1) "N/A" denotes test is not applicable in this Test Report

(2) All tests are according to ANSI C63.10-2013

1.1 TEST FACTORY

Company Name:	Flux Compliance Service Laboratory
Address:	Room 105 Floor Bao hao Technology Building 1 NO.15 Gong ye West Road Hi-Tech Industrial, Song shan lake Dongguan
Telephone:	+86-769-27280901
Fax:	+86-769-27280901
FCC Test Firm Registration Number: 514908 Designation number: CN0127 A2LA accreditation number: 5545.01	

1.2 MEASUREMENT UNCERTAINTY

The reported uncertainty of measurement $y \pm U$, where expended uncertainty U is based on a standard uncertainty multiplied by a coverage factor of $k=2$, providing a level of confidence of approximately **95 %**.

No.	Item	Uncertainty
1	RF output power, conducted	± 0.71 dB
2	Unwanted Emissions, conducted	± 2.98 dB
3	Conducted Emission (9KHz-150KHz)	± 4.13 dB
4	Conducted Emission (150KHz-30MHz)	± 4.74 dB
5	All emissions,radiated(<1G) 30MHz-1000MHz	± 3.2 dB
6	All emissions,radiated (1GHz -18GHz)	± 3.66 dB
7	All emissions,radiated (18GHz -40GHz)	± 4.31 dB

2. GENERAL INFORMATION

2.1 GENERAL DESCRIPTION OF THE EUT

Product Name	Smart curtain robot
Trade Name	N/A
Model Name	LY1678
Series Model	N/A
Model Difference	The above product with same circuit, PCB layout, electrical parts, materials and wiring structures, Appearance shape, the materials of decorative accessories is same, only different color.
Frequency	433.92MHZ
Modulation	ASK
Antenna type	Internal antenna
Power Supply	DC 3.7V
Hardware version number	V1.0
Software version number	V1.0
Connecting I/O Port(s)	Please refer to the User's Manual

Note:

1. For a more detailed features description, please refer to the manufacturer's specifications or the User's Manual.
2. Table for Filed Antenna

Ant.	Brand	Model Name	Antenna Type	Connector	Gain (dBi)	NOTE
1	N/A	CBDZ	Internal Antenna	N/A	1.0dBi	Antenna

2.2 DESCRIPTION OF THE TEST MODES

To investigate the maximum EMI emission characteristics generates from EUT, the test system was pre-scanning tested base on the consideration of following EUT operation mode or test configuration mode which possible have effect on EMI emission level. Each of these EUT operation mode(s) or test configuration mode(s) mentioned above was evaluated respectively.

This sample triggers the emission frequency via the remote control.

Configuration and peripherals

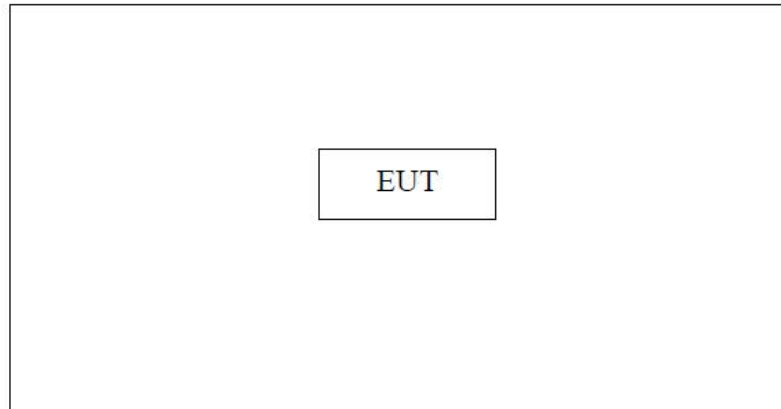

Test environment conditions

During the measurement the environmental conditions were within the listed ranges:

Temperature range: 21-25°C

Humidity range: 40-75%

Pressure range: 86-106kPa

2.3 DESCRIPTION OF NECESSARY ACCESSORIES AND SUPPORT UNITS

The EUT has been tested as an independent unit together with other necessary accessories or support units. The following support units or accessories were used to form a representative test configuration during the tests.

Necessary accessories

Item	Equipment	Mfr/Brand	Model/Type No.	Serial No.	Note

Support units

Item	Equipment	Mfr/Brand	Model/Type No.	Serial No.	Note

Note:

- (1) The support equipment was authorized by Declaration of Confirmation.
- (2) For detachable type I/O cable should be specified the length in cm in 『Length』 column.
- (3) “YES” is means “shielded” “with core”; “NO” is means “unshielded” “without core”.

2.4 EQUIPMENTS LIST

Radiation Test equipment

Kind of Equipment	Manufacturer	Type No.	Company No.	Last calibration	Calibrated until
EMI Test Receiver	R&S	ESRP 3	FCS-E001	2022.02.10	2023.02.09
Signal Analyzer	R&S	FSV40-N	FCS-E012	2022.02.10	2023.02.09
Active loop Antenna	ZHINAN	ZN30900C	FCS-E013	2022.02.10	2023.02.09
Bilog Antenna	SCHWARZBECK	VULB 9168	FCS-E002	2022.02.10	2023.02.09
Horn Antenna	SCHWARZBECK	BBHA 9120D	FCS-E003	2022.02.10	2023.02.09
SHF-EHF Horn Antenna (18G-40GHz)	A-INFO	LB-180400-KF	FCS-E018	2022.02.10	2023.02.09
Pre-Amplifier(0.1M-3G Hz)	EMCI	EM330N	FCS-E004	2022.02.10	2023.02.09
Pre-Amplifier (1G-18GHz)	N/A	TSAMP-0518SE	FCS-E014	2022.02.10	2023.02.09
Pre-Amplifier (18G-40GHz)	TERA-MW	TRLA-0400	FCS-E019	2022.02.10	2023.02.09
Temperature & Humidity	HTC-1	victor	FCS-E005	2022.02.10	2023.02.09

Conduction Test equipment

Kind of Equipment	Manufacturer	Type No.	Company No.	Last calibration	Calibrated until
EMI Test Receiver	R&S	ESPI	FCS-E020	2022.02.10	2023.02.09
LISN	R&S	ENV216	FCS-E007	2022.02.10	2023.02.09
LISN	ETS	3810/2NM	FCS-E009	2022.02.10	2023.02.09
Temperature & Humidity	HTC-1	victor	FCS-E008	2022.02.10	2023.02.09

RF Connected Test

Kind of Equipment	Manufacturer	Type No.	Company No.	Last calibration	Calibrated until
Spectrum Analyzer	Keysight	N9020A	FCS-E015	2022.02.10	2023.02.09
Spectrum Analyzer	Agilent	E4447A	MY50180039	2022.02.10	2023.02.09
Spectrum Analyzer	R&S	FSV-40	101499	2022.02.10	2023.02.09

3 CONDUCTED EMISSION MEASUREMENT

3.1 LIMIT

Operating frequency band. In case the emission fall within the restricted band specified on Part 207(a) limit in the table below has to be followed.

FREQUENCY (MHz)	Conducted Emissionlimit (dBuV)	
	Quasi-peak	Average
0.15 -0.5	66 - 56 *	56 - 46 *
0.50 -5.0	56.00	46.00
5.0 -30.0	60.00	50.00

Note:

- (1) The tighter limit applies at the band edges.
- (2) The limit of " * " marked band means the limitation decreases linearly with the logarithm of the frequency in the range.

3.2 TEST PROCEDURE

The following table is the setting of the receiver

Receiver Parameters	Setting
Attenuation	10 dB
Start Frequency	0.15 MHz
Stop Frequency	30 MHz
IF Bandwidth	9 kHz

- a. The EUT was 0.8 meters from the horizontal ground plane and 0.4 meters from the vertical ground plane with EUT being connected to the power mains through a line impedance stabilization network (LISN). All other support equipments powered from additional LISN(s). The LISN provide 50 Ohm/ 50uH of coupling impedance for the measuring instrument.
- b. Interconnecting cables that hang closer than 40 cm to the ground plane shall be folded back and forth in the center forming a bundle 30 to 40 cm long.
- c. I/O cables that are not connected to a peripheral shall be bundled in the center. The end of the cable may be terminated, if required, using the correct terminating impedance. The overall length shall not exceed 1 m.
- d. LISN at least 80 cm from nearest part of EUT chassis.
- e. For the actual test configuration, please refer to the related Item –EUT Test Photos.

3.3 TEST SETUP

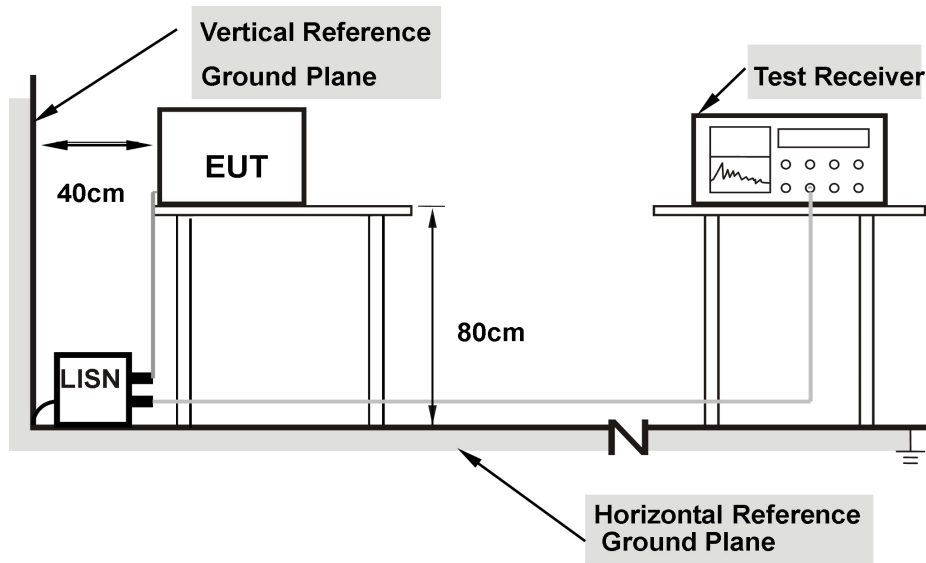

- Note:**
- 1.Support units were connected to second LISN.
 - 2.Both of LISNs (AMN) are 80 cm from EUT and at least 80 from other units and other metal planes

3.4 TEST RESULTS

Temperature:	25°C	Relative Humidity:	50%
Test Mode:	ASK	Test Voltage:	DC 5V
Phase:	L	Result:	Pass

No.	Frequency (MHz)	Reading (dBuV)	Correct Factor(dB/m)	Result (dBuV/m)	Limit (dBuV/m)	Margin (dB)	Remark
1	0.1590	39.95	9.78	49.73	65.52	15.79	QP
2	0.1590	21.46	9.78	31.24	55.52	24.28	AVG
3	0.2535	33.79	9.81	43.60	61.64	18.04	QP
4	0.2535	17.25	9.81	27.06	51.64	24.58	AVG
5	0.6090	30.73	9.88	40.61	56.00	15.39	QP
6	0.6090	17.10	9.88	26.98	46.00	19.02	AVG
7	0.9645	30.94	9.92	40.86	56.00	15.14	QP
8	0.9645	11.36	9.92	21.28	46.00	24.72	AVG
9	1.6530	22.42	9.93	32.35	56.00	23.65	QP
10	1.6530	9.84	9.93	19.77	46.00	26.23	AVG
11	5.3070	27.23	9.96	37.19	60.00	22.81	QP
12	5.3070	12.70	9.96	22.66	50.00	27.34	AVG

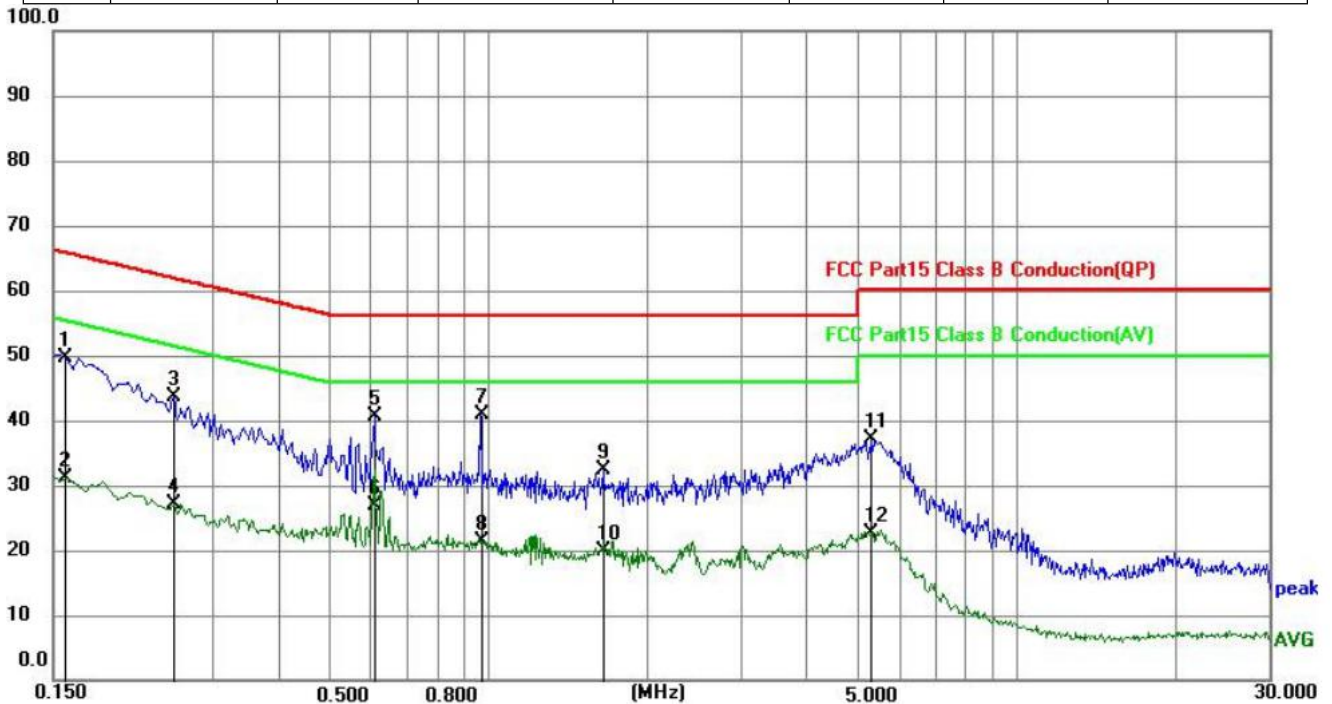

Temperature:	25°C	Relative Humidity:	50%
Test Mode:	ASK	Test Voltage:	DC 5V
Phase:	N	Result:	Pass

No.	Frequency (MHz)	Reading (dBuV)	Correct Factor(dB/m)	Result (dBuV/m)	Limit (dBuV/m)	Margin (dB)	Remark
1	0.1815	35.79	9.78	45.57	64.42	18.85	QP
2	0.1815	18.71	9.78	28.49	54.42	25.93	AVG
3	0.6090	29.35	9.88	39.23	56.00	16.77	QP
4	0.6090	23.11	9.88	32.99	46.00	13.01	AVG
5	0.9915	23.39	9.92	33.31	56.00	22.69	QP
6	0.9915	12.09	9.92	22.01	46.00	23.99	AVG
7	5.1900	23.54	10.03	33.57	60.00	26.43	QP
8	5.1900	15.09	10.03	25.12	50.00	24.88	AVG
9	9.6315	13.39	10.18	23.57	60.00	36.43	QP
10	9.6315	0.25	10.18	10.43	50.00	39.57	AVG
11	24.8325	9.06	10.27	19.33	60.00	40.67	QP
12	24.8325	-3.02	10.27	7.25	50.00	42.75	AVG

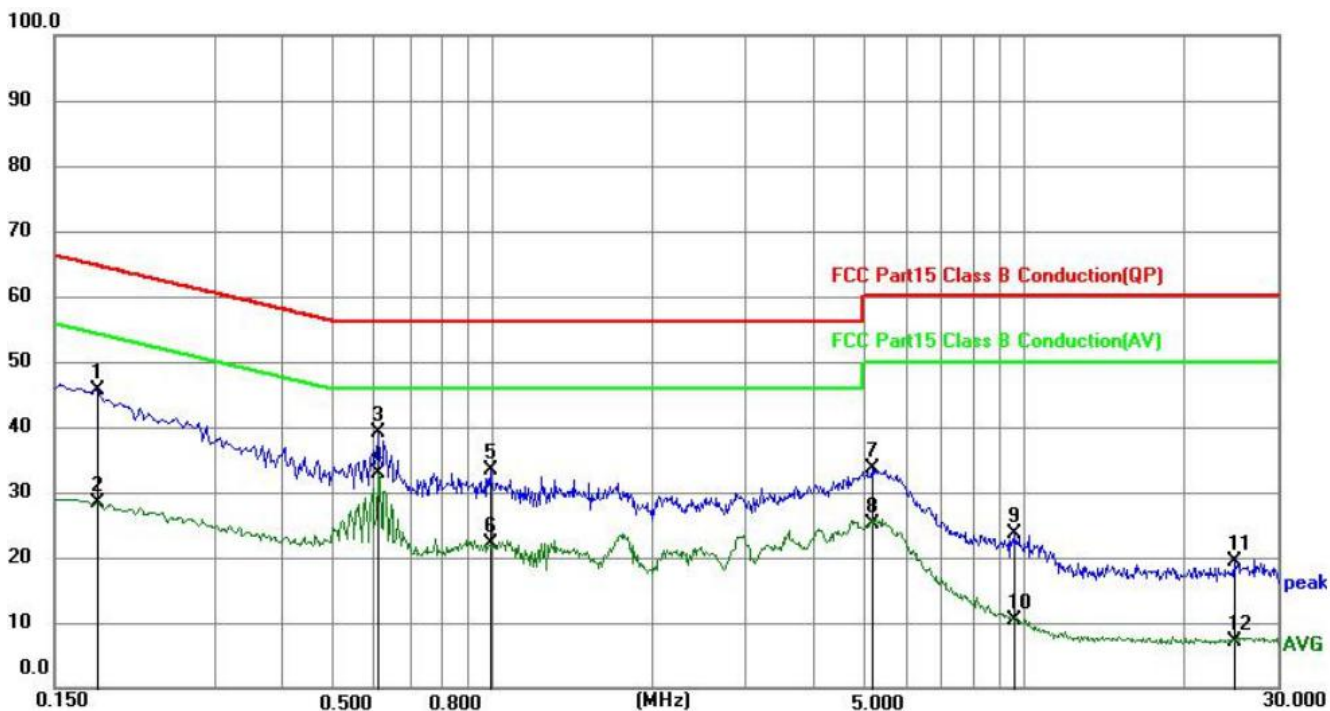

Remark:

1. All readings are Quasi-Peak and Average values.

4. RADIATED EMISSION MEASUREMENT

4.1 LIMIT

In any 100 kHz bandwidth outside the operating frequency band. In case the emission fall within the Restricted band specified on Part15.205(a)&209(a) limit in the table and according to ANSI C63.10-2013 below has to be followed

LIMITS OF RADIATED EMISSION MEASUREMENT (0.009mhz - 1000mhz)

Frequencies (MHz)	Field Strength (micorvolts/meter)	Measurement Distance (meters)
0.009~0.490	2400/F(KHz)	300
0.490~1.705	24000/F(KHz)	30
1.705~30.0	30	30
30~88	100	3
88~216	150	3
216~960	200	3
Above 960	500	3

LIMITS OF RADIATED EMISSION MEASUREMENT (1GHz-25 GHz)

FREQUENCY (MHz)	(dBuV/m) (at 3M)	
	PEAK	AVERAGE
Above 1000	74	54

LIMITS OF FIELD STRENGTH OF THE FUNDAMENTAL SIGNAL

FREQUENCY (MHz)	(dBuV/m) (at 3M)	
	PEAK	AVERAGE
433.92	100.83	80.83

Note: (1) The emission limits shown in the above table are based on measurements employing a CISPR QP detector except for the frequency bands 9-90kHz, 110-490kHz and above 1000MHz. Radiated emissions limits in these three bands are based on measurements employing an average detector

(2) At frequencies below 30MHz, measurement may be performed at a distance closer then that specified, and the limit at closer measurement distance can be extrapolated by below formula:
 $Limit_{3m}(dBuV/m) = Limit_{300m}(dBuV/m) + 40\log(300m/3m) = Limit_{300m}(dBuV/m) + 80$
 $Limit_{3m}(dBuV/m) = Limit_{30m}(dBuV/m) + 40\log(30m/3m) = Limit_{30m}(dBuV/m) + 40$

(3) Limit for this EUT

All the emissions appearing within 15.205 restricted frequency bands shall not exceed the limits shown in 15.209, all the other emissions include fundamental emission shall not exceed FCC 15.231 section (b) limit of comply with FCC 15.209 limit which permit higher emission level.

[Where F is the frequency in MHz, the formulas for calculating the maximum permitted fundamental field strengths are as follows: for the band 130-174 MHz, uV/m at 3 meters = $56.81818(F) - 6136.3636$; for the band 260-470 MHz, uV/m at 3 meters = $41.6667(F) - 7083.3333$. The maximum permitted unwanted emission level is 20 dB below the maximum permitted fundamental level.]

4.2 TEST PROCEDURE

- a. The measuring distance of at 3 m shall be used for measurements at frequency 0.009MHz up to 1GHz, and above 1GHz.
- b. The EUT was placed on the top of a rotating table 0.8 meters (above 1GHz is 1.5 m) above the ground at a 3 meter anechoic chamber test site. The table was rotated 360 degrees to determine the position of the highest radiation.
- c. The height of the equipment shall be 0.8 m (above 1GHz is 1.5 m); the height of the test antenna shall vary between 1 m to 4 m. horizontal and vertical polarizations of the antenna are set to make the measurement.
- d. The initial step in collecting conducted emission data is a spectrum analyzer peak detector mode pre-scanning the measurement frequency range. Significant peaks are then marked and then QuasiPeak detector mode re-measured.
- e. If the Peak Mode measured value compliance with and lower than Quasi Peak Mode Limit, the EUT shall be deemed to meet QP Limits and then no additional QP Mode measurement performed.
- f. For the actual test configuration, please refer to the related Item –EUT Test Photos.

Note:

Both horizontal and vertical antenna polarities were tested and performed pretest to three orthogonal axis. The worst case emissions were reported

4.3 TEST SETUP

(A) Radiated Emission Test-Up Frequency Below 30MHz

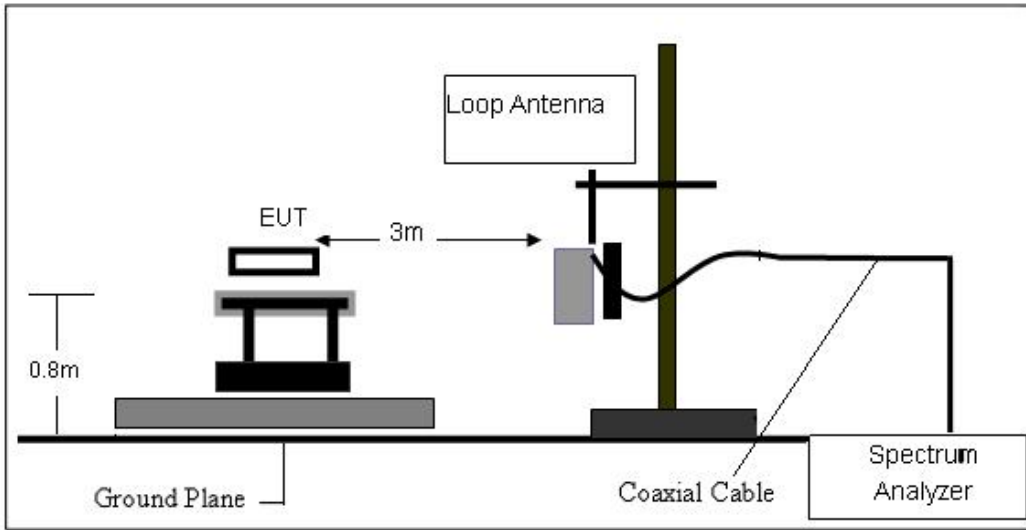

(B) Radiated Emission Test-Up Frequency 30MHz~1GHz

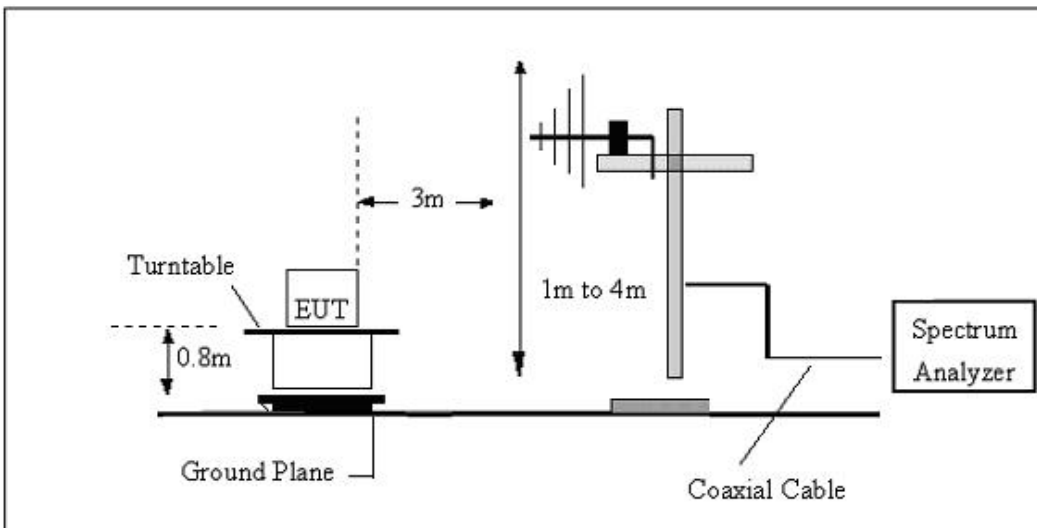

(C) Radiated Emission Test-Up Frequency Above 1GHz

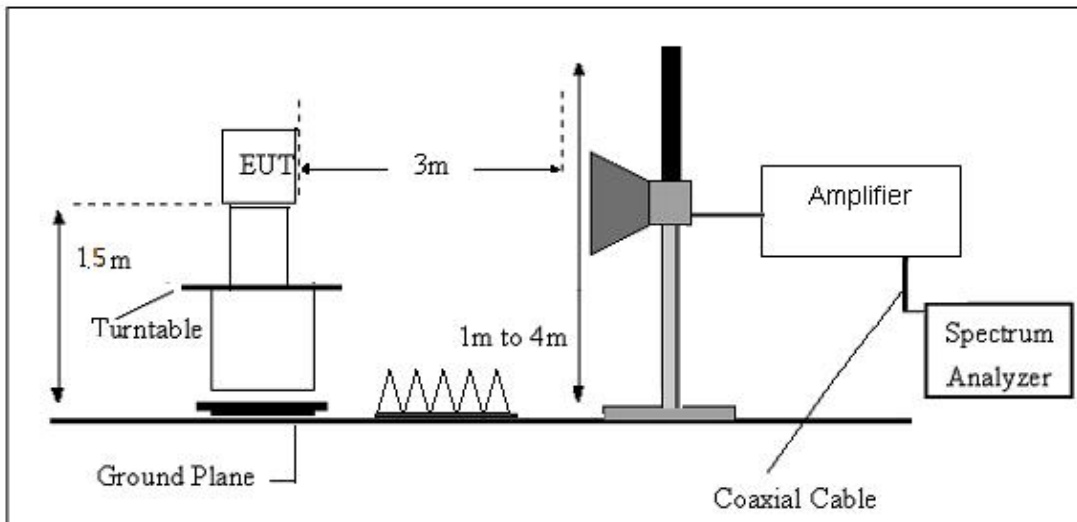

4.4 TEST RESULTS

Temperature:	25°C	Relative Humidity:	60%
Test Mode:	ASK	Test Voltage:	DC 3.7V

For field strength of the fundamental signal

Pake

Frequency (MHz)	Read Level (dBuV)	Antenna Factor (dB/m)	Cable Loss (dB)	Preamp Factor (dB)	Level (dBuV/m)	Limit Line (dBuV/m)	Over Limit (dB)	polarization
433.92	82.75	17.53	3.02	29.43	73.87	100.83	-26.96	Horizontal
433.92	87.62	17.53	3.02	29.43	78.74	100.83	-22.09	Vertical

AVG

Frequency (MHz)	Peak Value (dBuV/m)	Duty cycle factor	Average value (dBuV/m)	Limit Line (dBuV/m)	Over Limit (dB)	Polarization
433.92	73.87	-8.02	65.85	80.83	-14.98	Horizontal
433.92	78.74	-8.02	70.72	80.83	-10.11	Vertical

Remarks:

1. Final Level =Receiver Read level + Antenna Factor + Cable Loss – Preamplifier Factor
2. Average value=Peak value + Duty cycle factor

For spurious emission

(9KHz-30MHz)

Freq. (MHz)	Reading (dBuV/m)	Limit (dBuV/m)	Margin (dB)	State P/F	Test Result
--	--	--	--	--	PASS
--	--	--	--	--	PASS

Note:

The amplitude of spurious emissions which are attenuated by more than 20dB below the permissible value has no need to be reported.

Distance extrapolation factor =40 log (specific distance/test distance)(dB);

Limit line = specific limits (dBuv) + distance extrapolation factor.

(30MHZ-1000MHZ)

Temperature:	23.7°C	Relative Humidity:	61%
Test Voltage:	DC 3.7V	Phase:	Horizontal
Test Mode:	ASK		

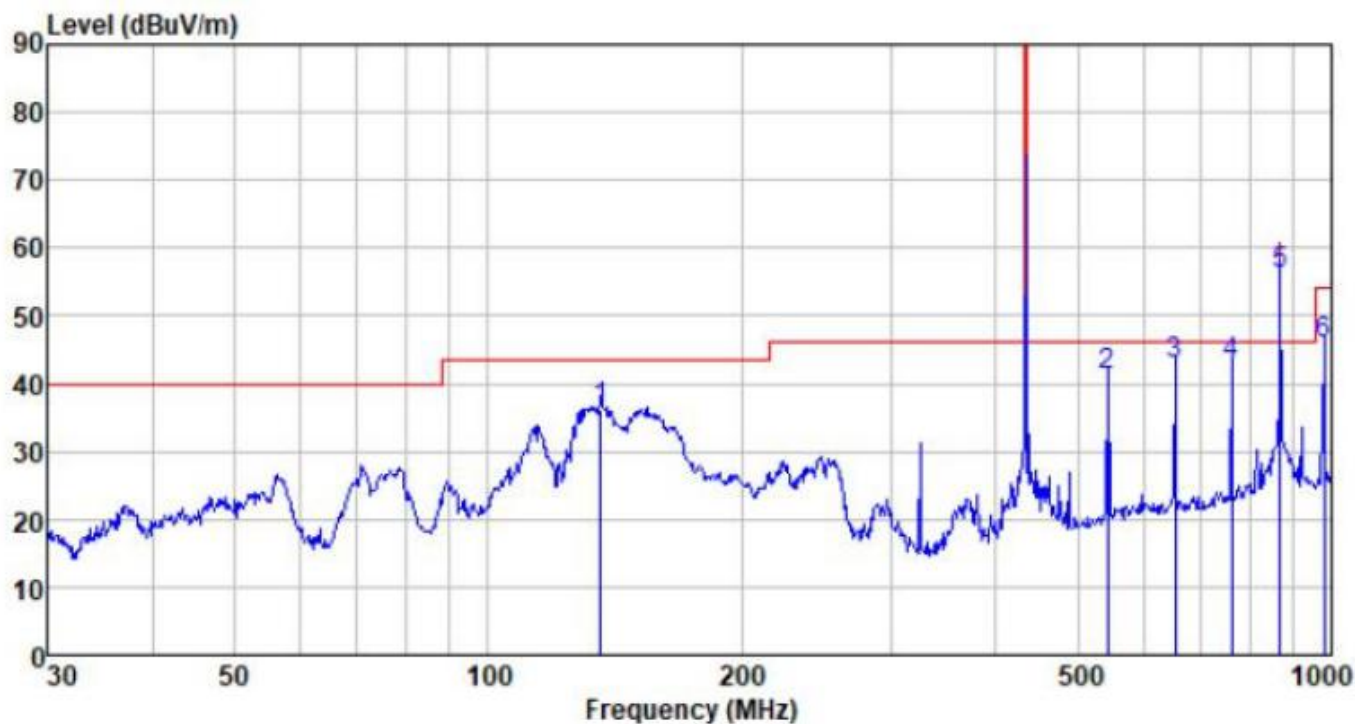

Freq MHz	Reading level dBuV	Antenna factor dB/m	Cable loss dB	Preamp factor dB	level dBuV	Limit level dBuV/m	Over limit dB	Remark
135.982	63.83	7.73	1.48	36.99	36.05	43.50	-7.45	QP
543.274	56.85	18.29	3.50	37.52	41.12	46.00	-4.88	QP
651.942	57.04	19.55	3.92	37.59	42.92	46.00	-3.08	QP
760.704	55.45	20.72	4.32	37.62	42.87	46.00	-3.13	QP
867.940	66.85	22.02	4.73	37.61	55.99	60.83	-4.84	QP
979.180	55.60	22.63	5.14	37.53	45.84	54.00	-8.16	QP

Temperature:	22.7°C	Relative Humidity:	61%
Test Voltage:	DC 3.7V	Phase:	Vertical
Test Mode:	ASK		

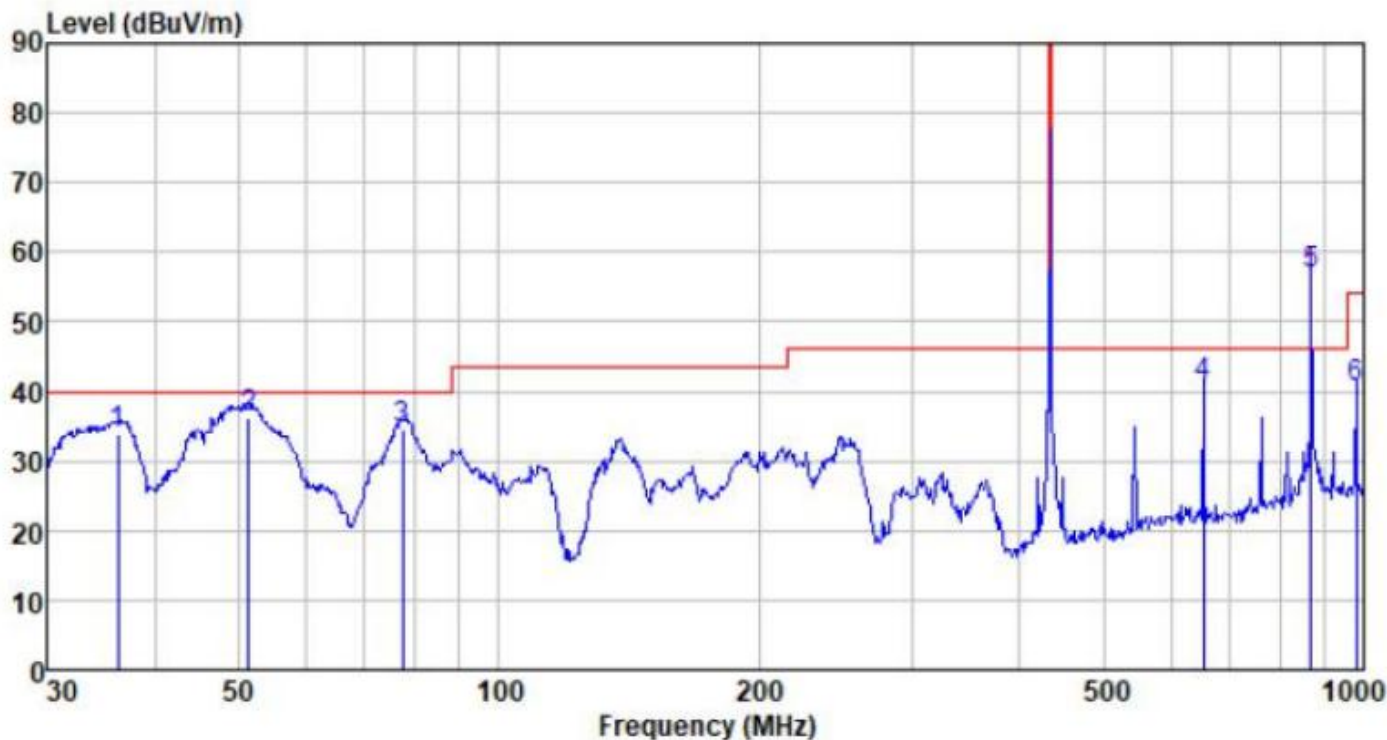

Freq MHz	Reading level dBuV	Antenna factor dB/m	Cable loss dB	Preamp factor dB	level dBuV	Limit level dBuV/m	Over limit dB	Remark
36.254	57.30	11.55	0.62	35.44	34.03	40.00	-5.97	QP
51.301	59.54	12.15	0.78	36.20	36.27	40.00	-3.73	QP
77.321	62.77	7.42	1.01	36.52	34.68	40.00	-5.32	QP
651.942	54.97	19.55	3.92	37.59	40.85	46.00	-5.15	QP
867.940	67.79	22.02	4.73	37.61	56.93	60.83	-3.90	QP
979.180	50.15	22.63	5.14	37.53	40.39	54.00	-13.61	QP

(ABOVE ~ 1GHZ)

Peak value:

Frequency (MHz)	Read Level (dBuV)	Antenna Factor (dB/m)	Cable Loss (dB)	Preamp Factor (dB)	Level (dBuV/m)	Limit Line (dBuV/m)	Over Limit (dB)	Polarization
1735.68	61.49	25.05	4.82	34.00	57.36	74.00	-16.64	Vertical
2169.60	55.81	27.74	5.15	34.27	54.43	74.00	-19.57	Vertical
2603.52	54.08	27.82	5.58	33.78	53.70	74.00	-20.30	Vertical
1735.68	60.21	25.05	4.82	34.00	56.08	74.00	-17.92	Horizontal
2169.60	55.51	27.74	5.15	34.27	54.13	74.00	-19.87	Horizontal
2603.52	53.69	27.82	5.58	33.78	53.31	74.00	-20.69	Horizontal

Average value:

Frequency (MHz)	Level (dBuV/m)	Duty cycle factor	Average value (dBuV/m)	Limit Line (dBuV/m)	Over Limit (dB)	Polarization
1735.68	57.36	-8.02	49.34	54.00	-4.66	Vertical
2169.60	54.43	-8.02	46.41	54.00	-7.59	Vertical
2603.52	53.70	-8.02	45.68	54.00	-8.32	Vertical
1735.68	56.08	-8.02	48.06	54.00	-5.94	Horizontal
2169.60	54.13	-8.02	46.11	54.00	-7.89	Horizontal
2603.52	53.31	-8.02	45.29	54.00	-8.71	Horizontal

Remarks:

1. *Final Level =Receiver Read level + Antenna Factor + Cable Loss – Preamplifier Factor*
2. *Average value=Peak value + Duty cycle factor*

5. TRANSMITTER TIME

5.1 LIMIT

A manually operated transmitter shall employ a switch that will automatically deactivate the transmitter within not more than 5 seconds of being released

5.2 TEST PROCEDURE

- a. The EUT' s RF signal was coupled to spectrum analyzer by antenna connected to spectrum analyzer.
- b. Set the spectrum to zero span mode, and centered of EUT frequency.
- c. Measure the stop transmitting time after release EUT button

5.3 TEST SETUP

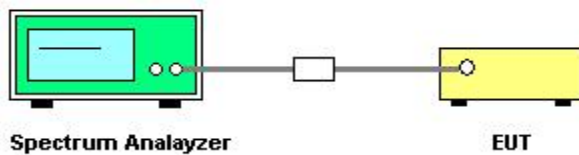

5.4 TEST RESULTS

Frequency(MHz)	Limit	Result
433.92	≤5s	Pass

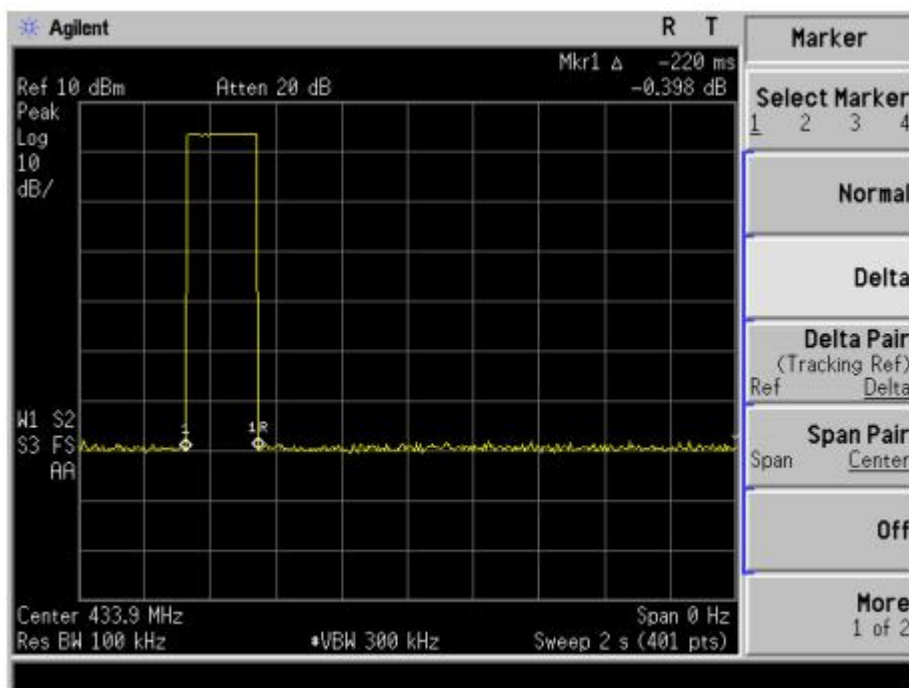

6. 20 DB BANDWIDTH TEST

6.1 LIMIT

The bandwidth of the emission shall be no wider than 0.25% of the center frequency of devices operation above 70MHz and below 900MHz.

6.2 TEST PROCEDURE

Connect EUT' s antenna output to spectrum analyzer by RF cable.

a.

The bandwidth of the fundamental frequency was measured by spectrum analyzer with 300Hz RBW and 1kHz VBW. The 20dB bandwidth is defined as the total spectrum the

b. power of which is higher than peak power minus 20dB

6.3 TEST SETUP

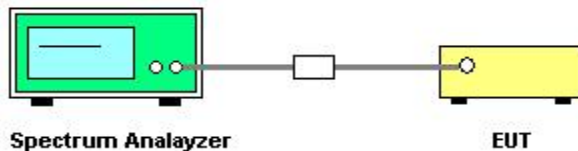

6.4 TEST RESULTS

Temperature:	25°C	Relative Humidity:	50%
Test Mode:	ASK	Test Voltage:	DC 3.7V

Frequency	20dB Bandwidth (KHz)	Result
433.92 MHz	481.331	PASS



7. DUTY CYCLE

7.1 LIMIT

None: for reporting purposes only.

7.2 TEST PROCEDURE

Set the Centre frequency of the spectrum analyzer to the transmitting frequency;

- a. Set the span=0MHz, RBW=100KHz, VBW=300KHz, Sweep time=100ms;

Trace mode = Single hold

7.3 TEST SETUP

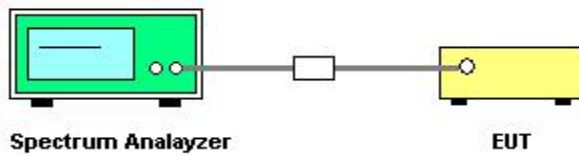

7.4 TEST RESULTS

Frequency	Duty Cycle
433.92 MHz	39.74%

The duty cycle is simply the on time divided by the period:

T on time = $0.325 \times 8 + 0.9917 \times 8 = 10.53$ (ms)

T period = 26.50 (ms)

Duty cycle = $10.53 / 26.50 = 39.74\%$

Duty cycle factor = $20 \log(0.3974) = -8.02$ dB

Original test data

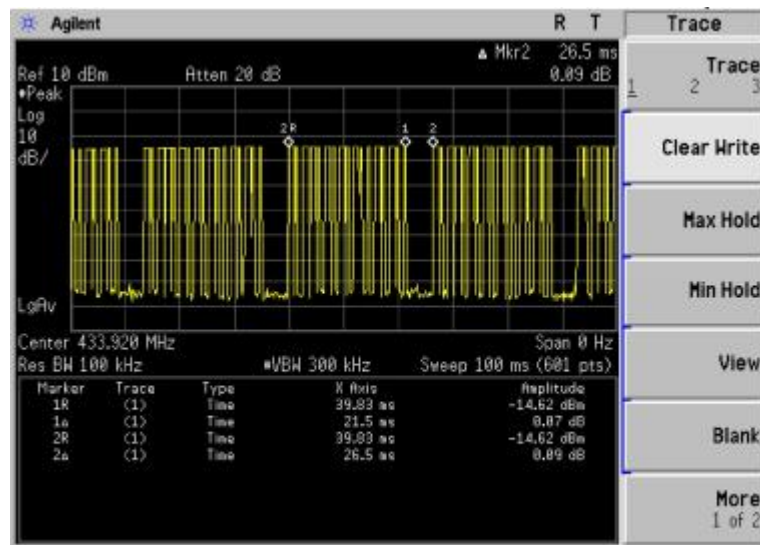

Copyright 2000-2012 Agilent Technologies

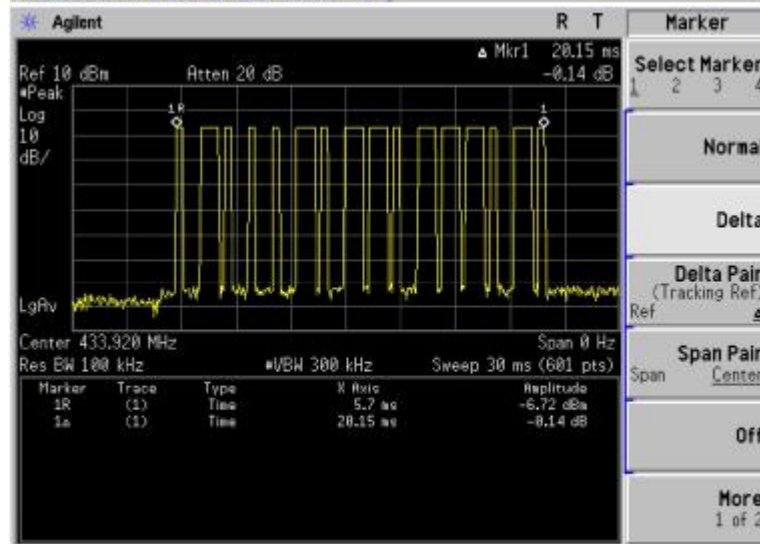

Copyright 2000-2012 Agilent Technologies

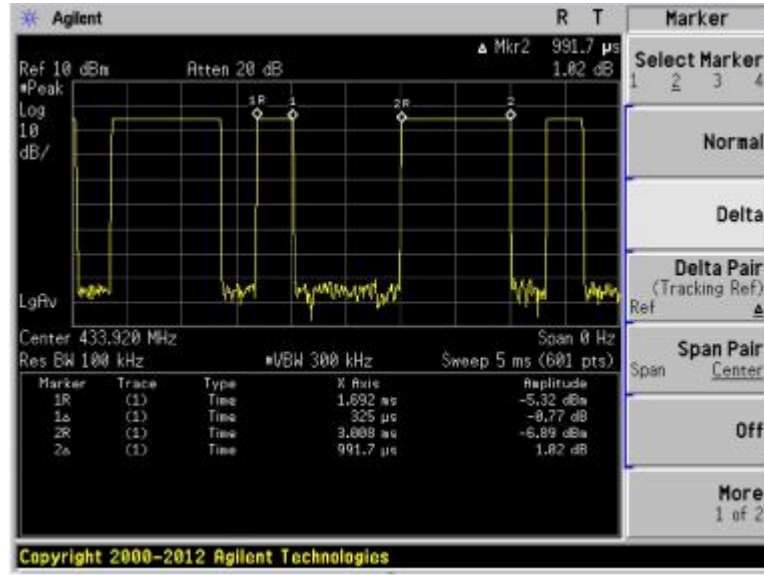

8 ANTENNA REQUIREMENT

8.1 STANDARD REQUIREMENT

15.203 requirement: For intentional device, according to 15.203: an intentional radiator shall be designed to ensure that no antenna other than that furnished by the responsible party shall be used with the device.

8.2 EUT ANTENNA

The antennas used for this product are internal antenna and other than that furnished by the responsible party shall be used with the device, the maximum peak gain of the transmit antenna is 1.0dBi.

XXXXXXXXEND OF THE REPORTXXXXXXXX