



# RF TEST REPORT

Product Name: Bluetooth headphone

Model Name: NC45

FCC ID: 2A4TBNC45

IC: 28241-NC45

Issued For : Shenzhen Srhythm Industry Co., Ltd

1602 Zhongan Building, Guangchang Road, Wenjing Community,  
Buji Street, Longgang District, Shenzhen, Guangdong 518000,  
China

Issued By : Shenzhen LGT Test Service Co., Ltd.

Room 205, Building 13, Zone B, Chen Hsong Industrial Park,  
No.177 Renmin West Road, Jinsha Community, Kengzi Street,  
Pingshan New District, Shenzhen, China

Report Number: LGT23C058RF01

Sample Received Date: Mar. 22, 2023

Date of Test: Mar. 22, 2023 – Apr. 06, 2023

Date of Issue: Apr. 06, 2023

The test report is effective only with both signature and specialized stamp. This report shall not be reproduced except in full without the written approval of the Laboratory. The results in this report only apply to the tested sample.



## TEST REPORT CERTIFICATION

**Applicant** Shenzhen Srhythm Industry Co., Ltd  
Address 1602 Zhongan Building, Guangchang Road, Wenjing Community, Buji Street, Longgang District, Shenzhen, Guangdong 518000, China

**Manufacturer** Shenzhen Srhythm Industry Co., Ltd  
Address 1602 Zhongan Building, Guangchang Road, Wenjing Community, Buji Street, Longgang District, Shenzhen, Guangdong 518000, China

Product Name Bluetooth headphone

Trademark N/A

Model Name NC45

Sample Status: Normal

APPLICABLE STANDARDS	
STANDARD	TEST RESULTS
FCC Part15.247 RSS-247 Issue 2, February 2017 RSS-Gen Issue 5, March 2019	PASS

Prepared by:

Zane Shan

Zane Shan  
Engineer

Approved by:

Vita Li

Vita Li  
Technical Director





<b>Table of Contents</b>	<b>Page</b>
<b>1. SUMMARY OF TEST RESULTS</b>	<b>6</b>
1.1 TEST FACTORY	7
1.2 MEASUREMENT UNCERTAINTY	7
<b>2. GENERAL INFORMATION</b>	<b>8</b>
2.2 DESCRIPTION OF THE TEST MODES	10
2.3 FREQUENCY HOPPING SYSTEM REQUIREMENTS	10
2.4 TABLE OF PARAMETERS OF TEST SOFTWARE SETTING	12
2.5 DESCRIPTION OF NECESSARY ACCESSORIES AND SUPPORT UNITS	12
2.6 EQUIPMENTS LIST	13
<b>3. EMC EMISSION TEST</b>	<b>14</b>
3.1 CONDUCTED EMISSION MEASUREMENT	14
3.2 RADIATED EMISSION MEASUREMENT	16
<b>4. CONDUCTED SPURIOUS &amp; BAND EDGE EMISSION</b>	<b>26</b>
4.1 LIMIT	26
4.2 TEST PROCEDURE	26
4.3 TEST SETUP	27
4.4 EUT OPERATION CONDITIONS	27
4.5 TEST RESULTS	27
<b>5. NUMBER OF HOPPING CHANNEL</b>	<b>28</b>
5.1 LIMIT	28
5.2 TEST PROCEDURE	28
5.3 TEST SETUP	28
5.4 EUT OPERATION CONDITIONS	28
5.5 TEST RESULTS	28
<b>6. AVERAGE TIME OF OCCUPANCY</b>	<b>29</b>
6.1 LIMIT	29
6.2 TEST PROCEDURE	29
6.3 TEST SETUP	29
6.4 EUT OPERATION CONDITIONS	29
6.5 TEST RESULTS	29
<b>7. HOPPING CHANNEL SEPARATION MEASUREMENT</b>	<b>30</b>
7.1 LIMIT	30
7.2 TEST PROCEDURE	30
7.3 TEST SETUP	30



<b>Table of Contents</b>	<b>Page</b>
7.4 EUT OPERATION CONDITIONS	30
7.5 TEST RESULTS	30
<b>8. BANDWIDTH TEST</b>	<b>31</b>
8.1 LIMIT	31
8.2 TEST PROCEDURE	31
8.3 TEST SETUP	31
8.4 EUT OPERATION CONDITIONS	31
8.5 TEST RESULTS	31
<b>9. OUTPUT POWER TEST</b>	<b>32</b>
9.1 LIMIT	32
9.2 TEST PROCEDURE	32
9.3 TEST SETUP	32
9.4 EUT OPERATION CONDITIONS	33
9.5 TEST RESULTS	33
<b>10. ANTENNA REQUIREMENT</b>	<b>34</b>
10.1 STANDARD REQUIREMENT	34
10.2 EUT ANTENNA	34
<b>APPENDIX I: TEST RESULTS</b>	<b>35</b>
DUTY CYCLE	35
MAXIMUM PEAK CONDUCTED OUTPUT POWER	39
-20DB BANDWIDTH	40
OCCUPIED CHANNEL BANDWIDTH	44
CARRIER FREQUENCIES SEPARATION	48
BAND EDGE	52
BAND EDGE (HOPPING)	57
CONDUCTED RF SPURIOUS EMISSION	62
NUMBER OF HOPPING CHANNEL	69
DWELL TIME	71
<b>APPENDIX II: PHOTOS OF TEST SETUP</b>	<b>74</b>



**Revision History**

Rev.	Issue Date	Contents
00	Apr. 06, 2023	Initial Issue



## 1. SUMMARY OF TEST RESULTS

Test procedures according to the technical standards:  
KDB 558074 D01 15.247 Meas Guidance v05r02.

<b>FCC Part 15.247, Subpart C RSS-247 Issue 2</b>			
Standard Section	Test Item	Judgment	Remark
15.207 RSS-Gen (8.8&7.2)	Conducted Emission	N/A	--
15.247(a)(1) RSS-247 (5.1)	Hopping Channel Separation	PASS	--
15.247(a)(1)&(b)(1) RSS-247 (5.1)	Output Power	PASS	--
15.209 RSS-247 (5.5)	Radiated Spurious Emission	PASS	--
15.247(d) RSS-247 (5.5)	Conducted Spurious & Band Edge Emission	PASS	--
15.247(a)(iii) RSS-247 (5.1)	Number of Hopping Frequency	PASS	--
15.247(a)(iii) RSS-247 (5.1)	Dwell Time	PASS	--
15.247(a)(1) RSS-247 (5.1) RSS-Gen (6.7)	Bandwidth	PASS	--
15.205 RSS-Gen (8.9&8.10)	Restricted bands of operation	PASS	--
Part 15.247(d)/part 15.209(a) RSS-247 (5.5)	Band Edge Emission	PASS	--
15.203 RSS-Gen (6.8)	Antenna Requirement	PASS	--

### NOTE:

- (1) 'N/A' denotes test is not applicable in this Test Report.
- (2) All tests are according to ANSI C63.10-2013.



## 1.1 TEST FACTORY

Company Name:	Shenzhen LGT Test Service Co., Ltd.
Address:	Room 205, Building 13, Zone B, Chen Hsong Industrial Park, No.177 Renmin West Road, Jinsha Community, Kengzi Street, Pingshan New District, Shenzhen, China
Accreditation Certificate	A2LA Certificate No.: 6727.01
	FCC Registration No.: 746540
	CAB ID: CN0136

## 1.2 MEASUREMENT UNCERTAINTY

The reported uncertainty of measurement  $y \pm U$ , where expanded uncertainty  $U$  is based on a standard uncertainty multiplied by a coverage factor of  $k=2$ , providing a level of confidence of approximately **95** %.

No.	Item	Uncertainty
1	RF output power, conducted	$\pm 0.68\text{dB}$
2	Unwanted Emissions, conducted	$\pm 2.988\text{dB}$
3	All emissions, radiated 9K-30MHz	$\pm 2.84\text{dB}$
4	All emissions, radiated 30M-1GHz	$\pm 4.39\text{dB}$
5	All emissions, radiated 1G-6GHz	$\pm 5.10\text{dB}$
6	All emissions, radiated >6G	$\pm 5.48\text{dB}$
7	Conducted Emission (9KHz-150KHz)	$\pm 2.79\text{dB}$
8	Conducted Emission (150KHz-30MHz)	$\pm 2.80\text{dB}$



## 2. GENERAL INFORMATION

### 2.1 GENERAL DESCRIPTION OF THE EUT

Product Name	Bluetooth headphone
Trademark	N/A
Model Name	NC45
Series Model	N/A
Model Difference	N/A
Channel List	Please refer to the Note 2.
Bluetooth	Frequency:2402 – 2480 MHz Modulation: GFSK(1Mbps), $\pi/4$ -DQPSK(2Mbps), 8DPSK(3Mbps)
Antenna Type	Please refer to the Note 3.
Rated Input	5V 0.2A
Battery	3.7V
Hardware Version	N/A
Software Version	N/A
Connecting I/O Port(s)	Please refer to the Note 1.

Note:

1. For a more detailed features description, please refer to the manufacturer's specifications or the User Manual.





2.

Channel List					
Channel	Frequency (MHz)	Channel	Frequency (MHz)	Channel	Frequency (MHz)
00	2402	27	2429	54	2456
01	2403	28	2430	55	2457
02	2404	29	2431	56	2458
03	2405	30	2432	57	2459
04	2406	31	2433	58	2460
05	2407	32	2434	59	2461
06	2408	33	2435	60	2462
07	2409	34	2436	61	2463
08	2410	35	2437	62	2464
09	2411	36	2438	63	2465
10	2412	37	2439	64	2466
11	2413	38	2440	65	2467
12	2414	39	2441	66	2468
13	2415	40	2442	67	2469
14	2416	41	2443	68	2470
15	2417	42	2444	69	2471
16	2418	43	2445	70	2472
17	2419	44	2446	71	2473
18	2420	45	2447	72	2474
19	2421	46	2448	73	2475
20	2422	47	2449	74	2476
21	2423	48	2450	75	2477
22	2424	49	2451	76	2478
23	2425	50	2452	77	2479
24	2426	51	2453	78	2480
25	2427	52	2454		
26	2428	53	2455		

3. Table for Filed Antenna

Ant.	Brand	Model Name	Antenna Type	Connector	Gain (dBi)	NOTE
1	Li Tongchuang	RANT5221F245M02	Chip Antenna	N/A	3.59	BT ANT

The antenna information provide by manufacturer, applicable only to the tested sample identified in the report.



## 2.2 DESCRIPTION OF THE TEST MODES

To investigate the maximum EMI emission characteristics generated from EUT, the test system was pre-scanning tested based on the consideration of following EUT operation mode or test configuration mode which possibly have effect on EMI emission level. Each of these EUT operation mode(s) or test configuration mode(s) mentioned above was evaluated respectively.

Worst Mode	Description	Data Rate/Modulation
Mode 1	TX CH00	1Mbps/GFSK
Mode 2	TX CH39	1Mbps/GFSK
Mode 3	TX CH78	1Mbps/GFSK
Mode 4	TX CH00	2 Mbps/ $\pi/4$ -DQPSK
Mode 5	TX CH39	2 Mbps/ $\pi/4$ -DQPSK
Mode 6	TX CH78	2 Mbps/ $\pi/4$ -DQPSK
Mode 7	TX CH00	3 Mbps/8DPSK
Mode 8	TX CH39	3 Mbps/8DPSK
Mode 9	TX CH78	3 Mbps/8DPSK
Mode 10	Hopping	GFSK
Mode 11	Hopping	$\pi/4$ -DQPSK
Mode 12	Hopping	8DPSK

Note:

- (1) The measurements are performed at all Bit Rate of Transmitter, the worst data was reported.
- (2) We tested for all available U.S. voltage and frequencies (For 120V, 50/60Hz and 240V, 50/60Hz) for which the device is capable of operation, and the worst case of 120V/ 60Hz is shown in the report.
- (3) The battery is fully charged during the radiated and RF conducted test.

For AC Conducted Emission

Test Case	
AC Conducted Emission	Mode 13: Keeping BT TX

## 2.3 FREQUENCY HOPPING SYSTEM REQUIREMENTS

(1) Standard and Limit

According to FCC Part 15.247(a)(1), The system shall hop to channel frequencies that are selected at the system hopping rate from a pseudo randomly ordered list of hopping frequencies. Each frequency must be used equally on the average by each transmitter. The system receivers shall have input bandwidths that match the hopping channel bandwidths of their corresponding transmitters and shall shift frequencies in synchronization with the transmitted signals.

Frequency hopping spread spectrum systems are not required to employ all available hopping channels during each transmission. However, the system, consisting of both the transmitter and the receiver, must be designed to comply with all of the regulations in this section should the transmitter be presented with a continuous data (or information) stream. In addition, a system employing short transmission bursts must comply with the definition of a frequency hopping system and must distribute its transmissions over the minimum number of hopping channels specified in this section. The incorporation of intelligence within a frequency hopping spread spectrum system that permits the system to recognize other users within the spectrum band so that it individually and independently chooses and adapts its hop sets to avoid hopping on occupied channels is permitted. The coordination of frequency hopping systems in any other manner for the express purpose of avoiding the simultaneous occupancy of individual hopping frequencies by multiple transmitters is not permitted.

(2) The Pseudorandom sequence may be generated in a nine-stage shift register whose 5<sup>th</sup> and 9<sup>th</sup>



stage outputs are added in a modulo-two addition stage. And the result is fed back to the input of the first stage. The sequence begins with the first one of 9 consecutive ones: i.e. the shift register is initialized with nine ones.

Number of shift register stages:9

Length of pseudo-random sequence: $2^9-1=511$ bits

Longest sequence of zeros: 8(non-inverted signal)

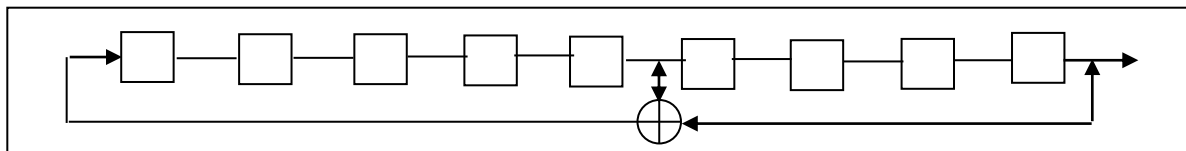

Linear Feedback Shift Register for Generator of the PRBS sequence

An example of Pseudorandom Frequency Hopping Sequence as follow:

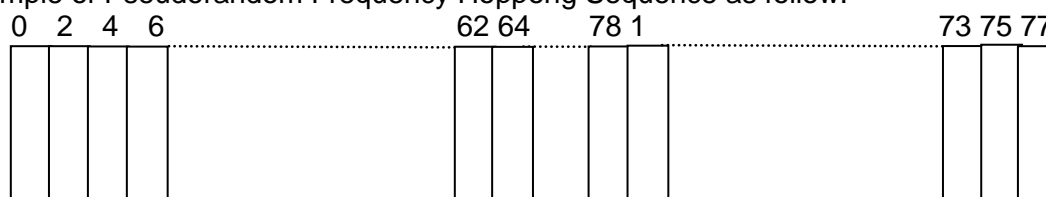

Each frequency used equally on the average by each transmitter.

The system receivers have input bandwidths that match the hopping channel bandwidths of their corresponding transmitters and shift frequencies in synchronization with the transmitted signals.

### (3) Frequency Hopping System

This transmitter device is frequency hopping device and complies with FCC part 15.247 rule.

This device uses Bluetooth radio which operates in 2400-2483.5 MHz band. Bluetooth uses a radio technology called frequency-hopping spread spectrum, which chops up the data being sent and transmits chunks of it on up to 79 bands (1 MHz each; centred from 2402 to 2480 MHz) in the range 2,400-2,483.5MHz. The transmitter switches hop frequencies 1,600 times per second to assure a high degree of data security. All Bluetooth devices participating in a given piconet are synchronized to the frequency-hopping channel for the piconet. The frequency hopping sequence is determined by the master's device address and the phase of the hopping sequence (the frequency to hop at a specific time) is determined by the master's internal clock. Therefore, all slaves in a piconet must know the master's device address and must synchronize their clocks with the master's clock.

Adaptive Frequency Hopping (AFH) was introduced in the Bluetooth specification to provide an effective way for a Bluetooth radio to counteract normal interference. AFH identifies "bad" channels, where either other wireless devices are interfering with the Bluetooth signal or the Bluetooth signal is interfering with another device. The AFH-enabled Bluetooth device will then communicate with other devices within its piconet to share details of any identified bad channels. The devices will then switch to alternative available "good" channels, away from the areas of interference, thus having no impact on the bandwidth used.

This device was tested with a bluetooth system receiver to check that the device maintained hopping synchronization, and the device complied with these requirements FCC Part 15.247 rule.



## 2.4 TABLE OF PARAMETERS OF TEST SOFTWARE SETTING

During testing channel & power controlling software provided by the customer was used to control the operating channel as well as the output power level. The RF output power selection is for the setting of RF output power expected by the customer and is going to be fixed on the firmware of the final end product power parameters of FHSS.

Type	Mode Or Modulation type	ANT Gain(dBi)	Power Class	Software For Testing
BR+EDR	GFSK	3.59	Default	non signaling
	$\pi/4$ -DQPSK		Default	
	8DPSK		Default	

## 2.5 DESCRIPTION OF NECESSARY ACCESSORIES AND SUPPORT UNITS

The EUT has been tested as an independent unit together with other necessary accessories or support units. The following support units or accessories were used to form a representative test configuration during the tests.

### Accessories Equipment

Description	Manufacturer	Model	S/N	Rating

### Auxiliary Equipment

Description	Manufacturer	Model	S/N	Rating

Note:

- (1) For detachable type I/O cable should be specified the length in cm in 『Length』 column.
- (2) “YES” is means “with core”; “NO” is means “without core”.



## 2.6 EQUIPMENTS LIST

### Conducted Emission

Equipment	Manufacturer	Model No.	Serial No.	Cal. Date	Cal. Until
EMI Test Receiver	R&S	ESU	100372	2022.04.12	2023.04.11
LISN	COM-POWER	LI-115	02032	2022.04.13	2023.04.12
LISN	Schwarzbeck	NNLK 8121	00847	2022.08.19	2023.08.18
CE Cable	N.A	C01	N.A	2022.05.05	2023.05.04
Transient Limiter	CYBERTEK	EM5010A	E2250100049	2022.08.19	2023.08.18
Temperature & Humidity	KTJ	TA218B	N.A	2022.05.05	2023.05.04
Testing Software	EMC-I_V1.4.0.3_SKET				

### Radiation Test equipment

Kind of Equipment	Manufacturer	Type No.	Serial No.	Last calibration	Calibrated until
EMI Test Receiver	R&S	ESU	100372	2022.04.12	2023.04.11
Spectrum Analyzer	Keysight	N9010B	MY60242508	2022.04.29	2023.04.28
Bilog Antenna	Schwarzbeck	VULB 9168	01447	2022.12.12	2024.12.11
Horn Antenna	Schwarzbeck	3115	10SL0060	2022.06.02	2024.06.01
Pre-amplifier(0.1M-3GHz)	HP	8447D	2727A05655	2022.04.11	2023.04.10
Pre-amplifier(1-26.5G)	Agilent	8449B	3008A4722	2022.04.12	2023.04.11
RE Cable (9K-1G)	N.A	R01	N.A	2022.05.05	2023.05.04
RE Cable (1-26G)	N.A	R02	N.A	2022.05.05	2023.05.04
Temperature & Humidity	KTJ	TA218B	N.A	2022.05.05	2023.05.04
Testing Software	EMC-I_V1.4.0.3_SKET				

### RF Connected Test equipment

Kind of Equipment	Manufacturer	Type No.	Serial No.	Last calibration	Calibrated until
Signal Generator	Keysight	N5182B	MY59100717	2022.04.30	2023.04.29
Signal Analyzer	Keysight	N9010B	MY60242508	2022.04.29	2023.04.28
Temperature & Humidity	KTJ	TA218B	N/A	2022.05.05	2023.05.04
Temperature & Humidity test chamber	AISRY	LX-1000L	171200018	2022.05.10	2023.05.09
Attenuator	eastsheep	90db	N/A	2022.04.29	2023.04.28
Testing Software	MTS 8310_2.0.0.0_MWRF-TEST				



### 3. EMC EMISSION TEST

#### 3.1 CONDUCTED EMISSION MEASUREMENT

##### 3.1.1 POWER LINE CONDUCTED EMISSION LIMITS

The radio frequency voltage that is conducted back onto the AC power line on any frequency or frequencies, within the band 150 kHz to 30 MHz, shall not exceed the limits in the following table.

FREQUENCY (MHz)	Conducted Emissionlimit (dBuV)	
	Quasi-peak	Average
0.15 -0.5	66 - 56 *	56 - 46 *
0.50 -5.0	56.00	46.00
5.0 -30.0	60.00	50.00

Note:

- (1) The tighter limit applies at the band edges.
- (2) The limit of “ \* ” marked band means the limitation decreases linearly with the logarithm of the frequency in the range.

The following table is the setting of the receiver.

Receiver Parameters	Setting
Attenuation	10 dB
Start Frequency	0.15 MHz
Stop Frequency	30 MHz
IF Bandwidth	9 kHz



### 3.1.2 TEST PROCEDURE

- a. The EUT is 0.8 m from the horizontal ground plane and 0.4 m from the vertical ground plane with EUT being connected to the power mains through a line impedance stabilization network (LISN). All other support equipments are powered from additional LISN(s). The LISN provides 50 Ohm/ 50uH of coupling impedance for the measuring instrument.
- b. Interconnecting cables that hang closer than 40 cm to the ground plane shall be folded back and forth in the center forming a bundle 30 to 40 cm long.
- c. I/O cables that are not connected to a peripheral shall be bundled in the center. The end of the cable may be terminated, if required, using the correct terminating impedance. The overall length shall not exceed 1 m.
- d. LISN is at least 80 cm from the nearest part of EUT chassis.
- e. For the actual test configuration, please refer to the related Item –EUT Test Photos.

### 3.1.3 TEST SETUP

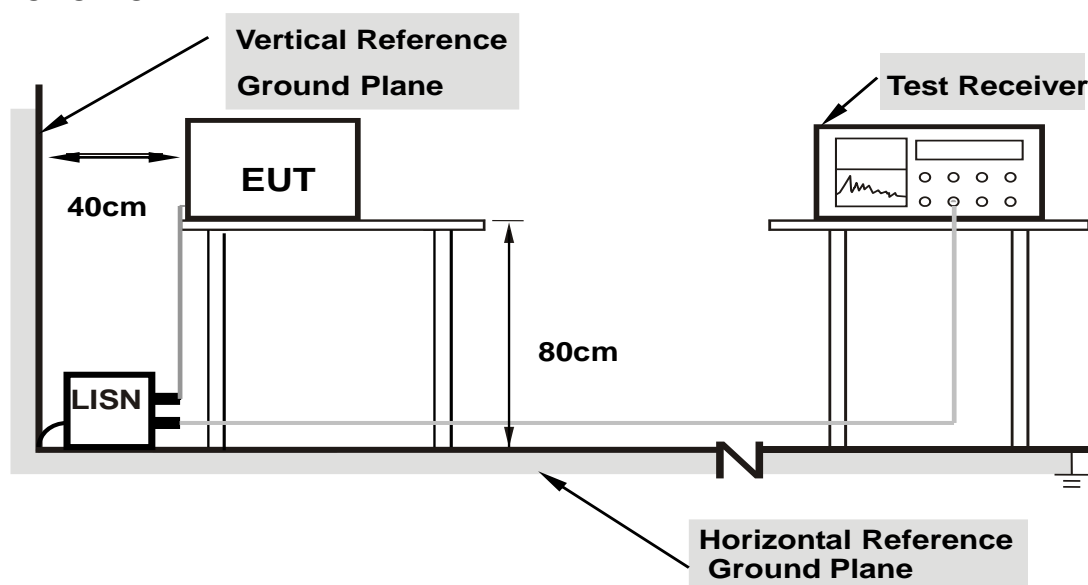

- Note: 1. Support units were connected to second LISN.**
- 2. Both of LISNs (AMN) are 80 cm from EUT and at least 80 cm from other units and other metal planes support units.**

### 3.1.4 EUT OPERATING CONDITIONS

The EUT was configured for testing in a typical fashion (as a customer would normally use it). The EUT has been programmed to continuously transmit during test. This operating condition was tested and used to collect the included data.

### 3.1.5 TEST RESULT

N/A



### 3.2 RADIATED EMISSION MEASUREMENT

#### 3.2.1 RADIATED EMISSION LIMITS

In any 100 kHz bandwidth outside the operating frequency band. In case the emission fall within the Restricted band specified on Part15.205 (a)&209(a) and RSS-Gen Issue 5&RSS-247 Issue 2, February 2017 (5.5) limit in the table and according to ANSI C63.10-2013 below has to be followed.

#### LIMITS OF RADIATED EMISSION MEASUREMENT (0.009MHz - 1000MHz)

Frequencies (MHz)	Field Strength (micorvolts/meter)	Measurement Distance (meters)
0.009~0.490	2400/F(KHz)	300
0.490~1.705	24000/F(KHz)	30
1.705~30.0	30	30
30~88	100	3
88~216	150	3
216~960	200	3
Above 960	500	3

#### LIMITS OF RADIATED EMISSION MEASUREMENT (1GHz-25 GHz)

FREQUENCY (MHz)	(dBuV/m) (at 3M)	
	PEAK	AVERAGE
Above 1000	74	54

Notes:

- (1) The limit for radiated test was performed according to FCC PART 15C.
- (2) The tighter limit applies at the band edges.
- (3) Emission level (dBuV/m)=20log Emission level (uV/m).

#### LIMITS OF RESTRICTED FREQUENCY BANDS

FREQUENCY (MHz)	FREQUENCY (MHz)	FREQUENCY (MHz)	FREQUENCY (GHz)
0.090-0.110	16.42-16.423	399.9-410	4.5-5.15
0.495-0.505	16.69475-16.69525	608-614	5.35-5.46
2.1735-2.1905	16.80425-16.80475	960-1240	7.25-7.75
4.125-4.128	25.5-25.67	1300-1427	8.025-8.5
4.17725-4.17775	37.5-38.25	1435-1626.5	9.0-9.2
4.20725-4.20775	73-74.6	1645.5-1646.5	9.3-9.5
6.215-6.218	74.8-75.2	1660-1710	10.6-12.7
6.26775-6.26825	108-121.94	1718.8-1722.2	13.25-13.4
6.31175-6.31225	123-138	2200-2300	14.47-14.5
8.291-8.294	149.9-150.05	2310-2390	15.35-16.2
8.362-8.366	156.52475-156.52525	2483.5-2500	17.7-21.4
8.37625-8.38675	156.7-156.9	2690-2900	22.01-23.12
8.41425-8.41475	162.0125-167.17	3260-3267	23.6-24.0
12.29-12.293	167.72-173.2	3332-3339	31.2-31.8
12.51975-12.52025	240-285	3345.8-3358	36.43-36.5
12.57675-12.57725	322-335.4	3600-4400	Above 38.6
13.36-13.41			





For Radiated Emission

Spectrum Parameter	Setting
Attenuation	Auto
Detector	Peak/QP/AV
Start Frequency	9 KHz/150KHz (Peak/QP/AV)
Stop Frequency	150KHz/30MHz (Peak/QP/AV)
RB / VB (emission in restricted band)	200Hz (From 9kHz to 0.15MHz)/ 9KHz (From 0.15MHz to 30MHz); 200Hz (From 9kHz to 0.15MHz)/ 9KHz (From 0.15MHz to 30MHz)

Spectrum Parameter	Setting
Attenuation	Auto
Detector	Peak/QP
Start Frequency	30 MHz (Peak/QP)
Stop Frequency	1000 MHz (Peak/QP)
RB / VB (emission in restricted band)	120 KHz / 300 KHz

Spectrum Parameter	Setting
Attenuation	Auto
Detector	Peak
Start Frequency	1000 MHz (Peak/AV)
Stop Frequency	10th carrier hamonic (Peak/AV)
RB / VB (emission in restricted band)	1 MHz / 3 MHz(Peak) 1 MHz/1/T MHz(AVG)

For Restricted band

Spectrum Parameter	Setting
Detector	Peak
Start/Stop Frequency	Lower Band Edge: 2310 to 2410 MHz Upper Band Edge: 2476 to 2500 MHz
RB / VB	1 MHz / 3 MHz(Peak) 1 MHz/1/T MHz(AVG)

Receiver Parameter	Setting
Attenuation	Auto
Start ~ Stop Frequency	9kHz~90kHz / RB 200Hz for PK & AV
Start ~ Stop Frequency	90kHz~110kHz / RB 200Hz for QP
Start ~ Stop Frequency	110kHz~490kHz / RB 200Hz for PK & AV
Start ~ Stop Frequency	490kHz~30MHz / RB 9kHz for QP



Start ~ Stop Frequency	30MHz~1000MHz / RB 120kHz for QP
------------------------	----------------------------------

### 3.2.2 TEST PROCEDURE

- The measuring distance at 3 m shall be used for measurements at frequency 0.009MHz up to 1GHz, and above 1GHz.
- The EUT was placed on the top of a rotating table 0.8 m (above 1GHz is 1.5 m) above the ground at a 3 m anechoic chamber test site. The table was rotated 360 degree to determine the position of the highest radiation.
- The height of the equipment shall be 0.8 m (above 1GHz is 1.5 m); the height of the test antenna shall vary between 1 m to 4 m. Horizontal and vertical polarization of the antenna are set to make the measurement.
- The initial step in collecting conducted emission data is a spectrum analyzer peak detector mode pre-scanning the measurement frequency range. Significant peaks are then marked and QuasiPeak detector mode will be re-measured.
- If the Peak Mode measured value is compliance with and lower than Quasi Peak Mode Limit, the EUT shall be deemed to meet QP Limits and no additional QP Mode measurement was performed.
- For the actual test configuration, please refer to the related Item –EUT Test Photos.

Note:

Both horizontal and vertical antenna polarities were tested and performed pretest to three orthogonal axis. The worst case emissions were reported.

### 3.2.3 DEVIATION FROM TEST STANDARD

No deviation.

### 3.2.4 TESTSETUP

#### (A) Radiated Emission Test-Up Frequency Below 30MHz

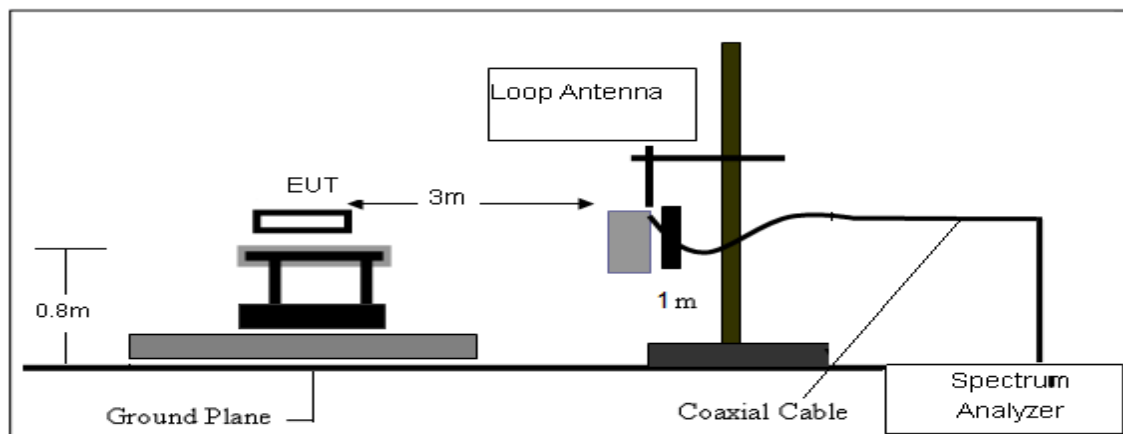

#### (B) Radiated Emission Test-Up Frequency 30MHz~1GHz

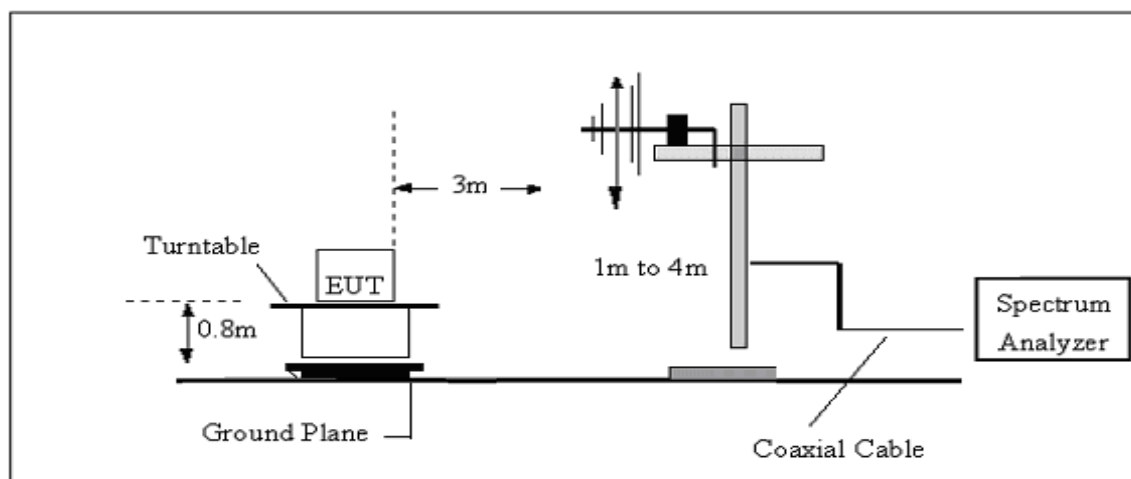



### (C) Radiated Emission Test-Up Frequency Above 1GHz

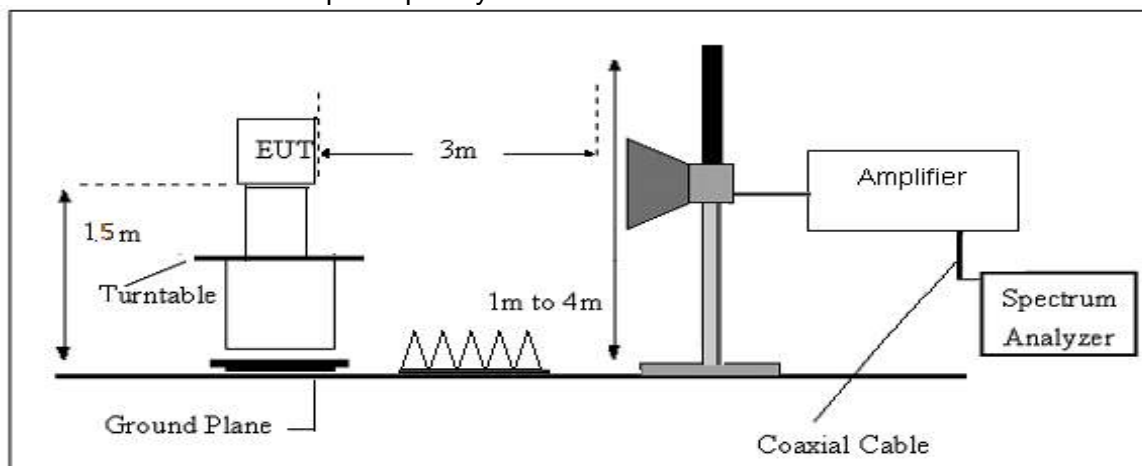

#### 3.2.5 EUT OPERATING CONDITIONS

Please refer to section 3.1.4 of this report.

#### 3.2.6 FIELD STRENGTH CALCULATION

The field strength is calculated by adding the Antenna Factor and Cable Factor and subtracting the Amplifier Gain and Duty Cycle Correction Factor (if any) from the measured reading. The basic equation with a sample calculation is as follows:

$$FS = RA + AF + CL - AG$$

Where

FS = Field Strength

CL = Cable Attenuation Factor (Cable Loss)

RA = Reading Amplitude

AG = Amplifier Gain

AF = Antenna Factor

For example

Frequency (MHz)	FS (dB $\mu$ V/m)	RA (dB $\mu$ V/m)	AF (dB)	CL (dB)	AG (dB)	Factor (dB)
300	40	58.1	12.2	1.6	31.9	-18.1

$$\text{Factor} = \text{AF} + \text{CL} - \text{AG}$$



### 3.2.7 TEST RESULTS

Project: LGT23C058	Test Engineer: Dylan.shi
EUT: Bluetooth headphone	Temperature: 27.1°C
M/N: NC45	Humidity: 72%RH
Test Voltage: Battery	Test Data: 2023-04-06
Test Mode: BT TX	
Note:	

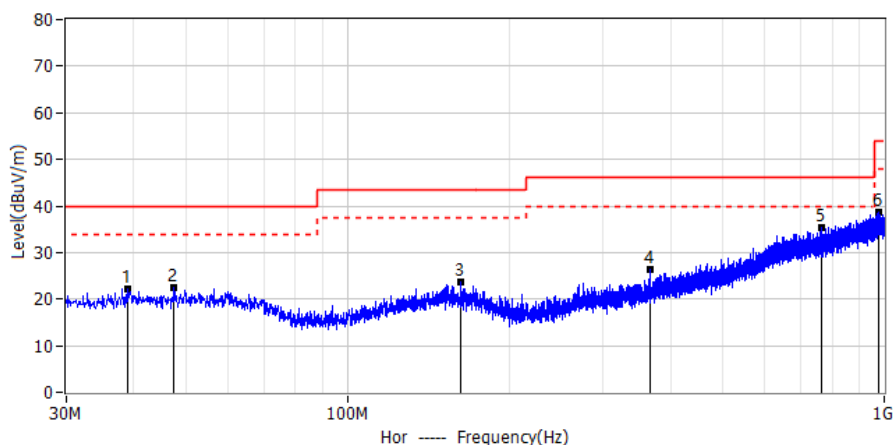

No.	Frequency	Reading dBuV	Factor dB/m	Level dBuV/m	Limit dBuV/m	Margin dB	Detector	Polar
1*	39.094MHz	2.89	19.23	22.12	40.00	-17.88	PK	Hor
2*	47.581MHz	3.29	19.29	22.58	40.00	-17.42	PK	Hor
3*	162.890MHz	3.71	19.82	23.53	43.50	-19.97	PK	Hor
4*	366.226MHz	4.51	21.76	26.27	46.00	-19.73	PK	Hor
5*	762.835MHz	4.53	30.68	35.21	46.00	-10.79	PK	Hor
6*	973.689MHz	4.26	34.42	38.68	54.00	-15.32	PK	Hor

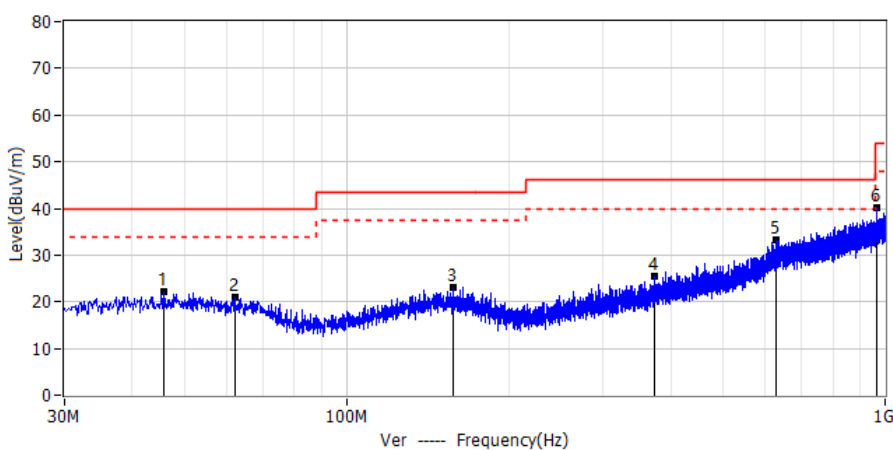

No.	Frequency	Reading dBuV	Factor dB/m	Level dBuV/m	Limit dBuV/m	Margin dB	Detector	Polar
1*	45.763MHz	2.89	19.24	22.13	40.00	-17.87	PK	Ver
2*	62.131MHz	2.60	18.51	21.11	40.00	-18.89	PK	Ver
3*	158.161MHz	3.23	19.87	23.10	43.50	-20.40	PK	Ver
4*	373.016MHz	3.40	22.00	25.40	46.00	-20.60	PK	Ver
5*	629.339MHz	4.58	28.70	33.28	46.00	-12.72	PK	Ver
6*	967.505MHz	5.72	34.30	40.02	54.00	-13.98	PK	Ver



Project: LGT23C058	Test Engineer: Dylan.shi
EUT: Bluetooth headphone	Temperature: 25.2°C
M/N: NC45	Humidity: 63%RH
Test Voltage: Battery	Test Data: 2023-04-03
Test Mode: DH5 2402	
Note:	

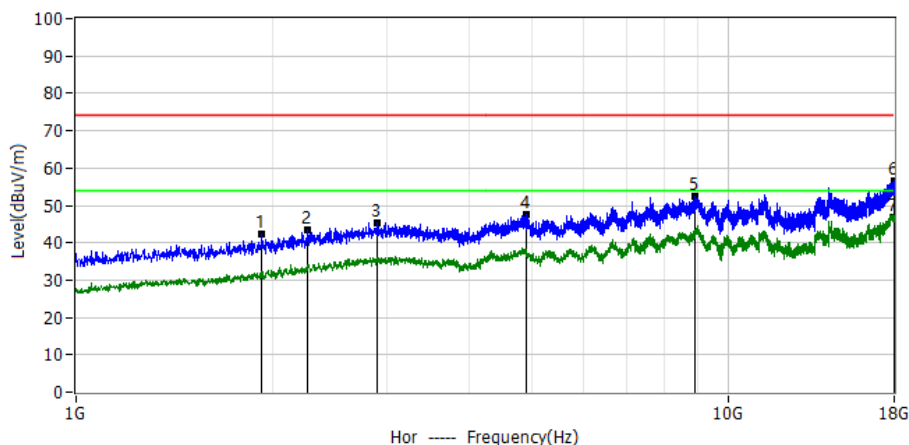

No.	Frequency	Reading dBuV	Factor dB/m	Level dBuV/m	Limit dBuV/m	Margin dB	Detector	Polar
1*	1.927GHz	59.36	-16.97	42.39	74.00	-31.61	PK	Hor
2*	2.267GHz	56.90	-13.43	43.47	74.00	-30.53	PK	Hor
3*	2.898GHz	54.09	-8.88	45.21	74.00	-28.79	PK	Hor
4*	4.912GHz	53.81	-6.07	47.74	74.00	-26.26	PK	Hor
5*	8.922GHz	53.86	-1.39	52.47	74.00	-21.53	PK	Hor
6*	17.964GHz	47.97	8.49	56.46	74.00	-17.54	PK	Hor
7*	17.964GHz	38.41	8.49	46.90	54.00	-7.10	AV	Hor

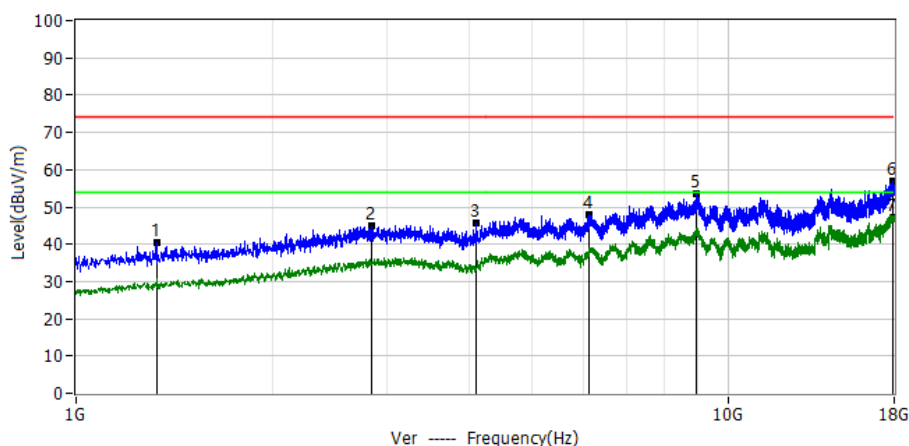

No.	Frequency	Reading dBuV	Factor dB/m	Level dBuV/m	Limit dBuV/m	Margin dB	Detector	Polar
1*	1.329GHz	62.21	-21.94	40.27	74.00	-33.73	PK	Ver
2*	2.834GHz	54.17	-9.22	44.95	74.00	-29.05	PK	Ver
3*	4.117GHz	52.95	-7.37	45.58	74.00	-28.42	PK	Ver
4*	6.126GHz	55.17	-7.30	47.87	74.00	-26.13	PK	Ver
5*	8.933GHz	55.06	-1.36	53.70	74.00	-20.30	PK	Ver
6*	17.900GHz	48.64	8.45	57.09	74.00	-16.91	PK	Ver
7*	17.900GHz	38.75	8.45	47.20	54.00	-6.80	AV	Ver



Project: LGT23C058	Test Engineer: Dylan.shi
EUT: Bluetooth headphone	Temperature: 25.2°C
M/N: NC45	Humidity: 63%RH
Test Voltage: Battery	Test Data: 2023-04-04
Test Mode: DH5 2440	
Note:	

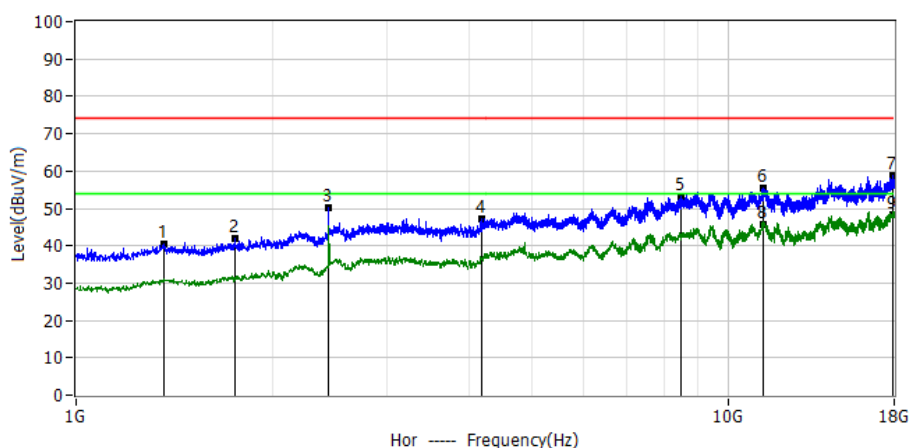

No.	Frequency	Reading dBuV	Factor dB/m	Level dBuV/m	Limit dBuV/m	Margin dB	Detector	Polar
1*	1.361GHz	62.17	-21.69	40.48	74.00	-33.52	PK	Hor
2*	1.754GHz	60.77	-18.69	42.08	74.00	-31.92	PK	Hor
3*	2.441GHz	61.69	-11.61	50.08	74.00	-23.92	PK	Hor
4*	4.181GHz	54.26	-7.10	47.16	74.00	-26.84	PK	Hor
5*	8.469GHz	55.81	-2.67	53.14	74.00	-20.86	PK	Hor
6*	11.351GHz	53.76	1.84	55.60	74.00	-18.40	PK	Hor
7*	17.947GHz	50.16	8.48	58.64	74.00	-15.36	PK	Hor
8*	11.351GHz	43.96	1.84	45.80	54.00	-8.20	AV	Hor
9*	17.947GHz	39.82	8.48	48.30	54.00	-5.70	AV	Hor

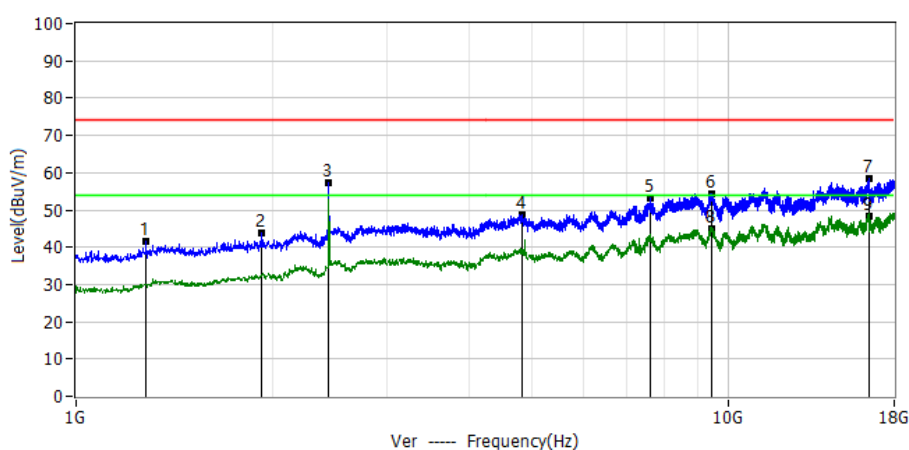

No.	Frequency	Reading dBuV	Factor dB/m	Level dBuV/m	Limit dBuV/m	Margin dB	Detector	Polar
1*	1.278GHz	63.95	-22.35	41.60	74.00	-32.40	PK	Ver
2*	1.929GHz	60.72	-16.95	43.77	74.00	-30.23	PK	Ver
3*	2.441GHz	68.99	-11.61	57.38	74.00	-16.62	PK	Ver
4*	4.838GHz	54.85	-6.02	48.83	74.00	-25.17	PK	Ver
5*	7.592GHz	57.27	-4.24	53.03	74.00	-20.97	PK	Ver
6*	9.466GHz	55.62	-1.17	54.45	74.00	-19.55	PK	Ver
7*	16.457GHz	51.53	6.97	58.50	74.00	-15.50	PK	Ver
8*	9.466GHz	46.17	-1.17	45.00	54.00	-9.00	AV	Ver
9*	16.457GHz	41.53	6.97	48.50	54.00	-5.50	AV	Ver



Project: LGT23C058	Test Engineer: Dylan.shi
EUT: Bluetooth headphone	Temperature: 25.2°C
M/N: NC45	Humidity: 63%RH
Test Voltage: Battery	Test Data: 2023-04-04
Test Mode: DH5 2480	
Note:	

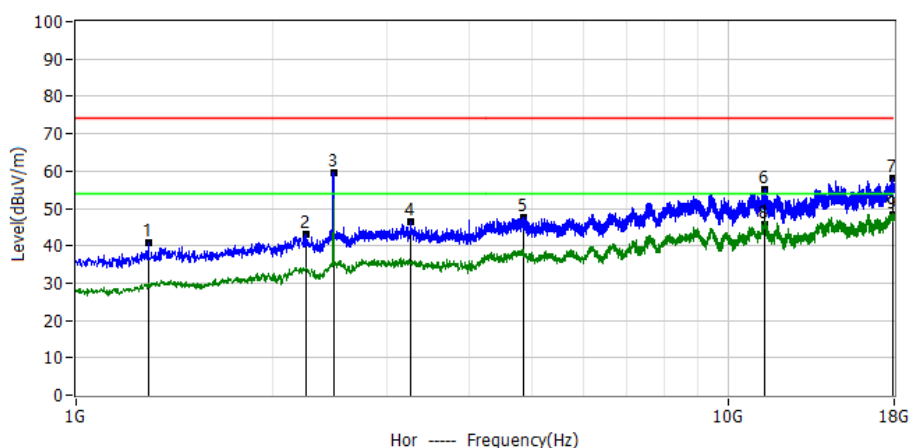

No.	Frequency	Reading dBuV	Factor dB/m	Level dBuV/m	Limit dBuV/m	Margin dB	Detector	Polar
1*	1.289GHz	63.16	-22.26	40.90	74.00	-33.10	PK	Hor
2*	2.252GHz	56.79	-13.59	43.20	74.00	-30.80	PK	Hor
3*	2.481GHz	70.62	-11.18	59.44	74.00	-14.56	PK	Hor
4*	3.257GHz	54.88	-8.42	46.46	74.00	-27.54	PK	Hor
5*	4.859GHz	53.63	-6.03	47.60	74.00	-26.40	PK	Hor
6*	11.385GHz	53.20	1.86	55.06	74.00	-18.94	PK	Hor
7*	17.926GHz	49.44	8.47	57.91	74.00	-16.09	PK	Hor
8*	11.385GHz	43.74	1.86	45.60	54.00	-8.40	AV	Hor
9*	17.926GHz	39.73	8.47	48.20	54.00	-5.80	AV	Hor

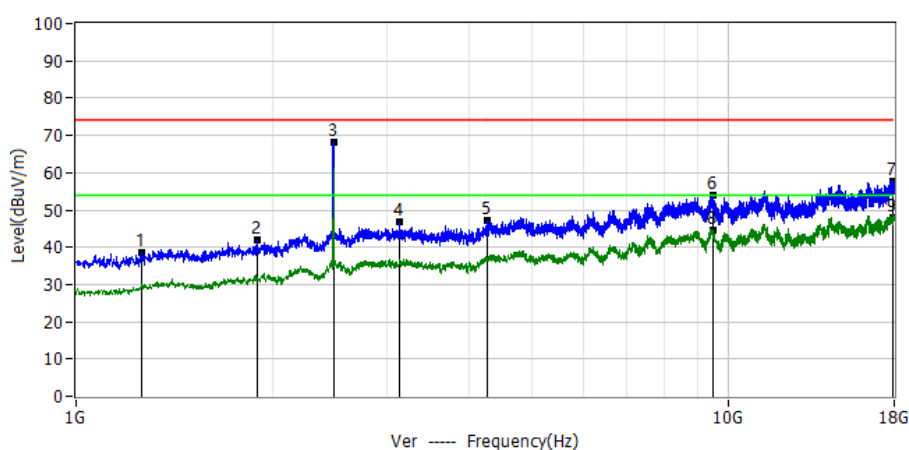

No.	Frequency	Reading dBuV	Factor dB/m	Level dBuV/m	Limit dBuV/m	Margin dB	Detector	Polar
1*	1.259GHz	61.21	-22.50	38.71	74.00	-35.29	PK	Ver
2*	1.899GHz	59.06	-17.25	41.81	74.00	-32.19	PK	Ver
3*	2.481GHz	79.40	-11.18	68.22	74.00	-5.78	PK	Ver
4*	3.140GHz	55.10	-8.39	46.71	74.00	-27.29	PK	Ver
5*	4.266GHz	53.99	-6.74	47.25	74.00	-26.75	PK	Ver
6*	9.468GHz	55.19	-1.17	54.02	74.00	-19.98	PK	Ver
7*	17.915GHz	49.39	8.46	57.85	74.00	-16.15	PK	Ver
8*	9.468GHz	45.87	-1.17	44.70	54.00	-9.30	AV	Ver
9*	17.915GHz	39.44	8.46	47.90	54.00	-6.10	AV	Ver



### 3.2.8 TEST RESULTS (BAND EDGE REQUIREMENTS)

Project: LGT23C058	Test Engineer: Dylan.shi
EUT: Bluetooth headphone	Temperature: 25.2°C
M/N: NC45	Humidity: 63%RH
Test Voltage: Battery	Test Data: 2023-04-03
Test Mode: DH5 2480	
Note:	

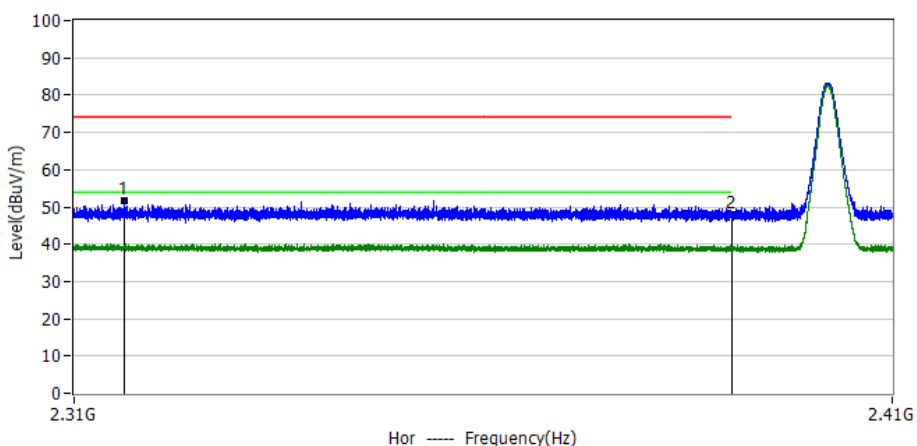

No.	Frequency	Reading dBuV	Factor dB/m	Level dBuV/m	Limit dBuV/m	Margin dB	Detector	Polar
1*	2.3160GHz	17.54	34.13	51.67	74.00	-22.33	PK	Hor
2*	2.3900GHz	14.05	33.95	48.00	74.00	-26.00	PK	Hor

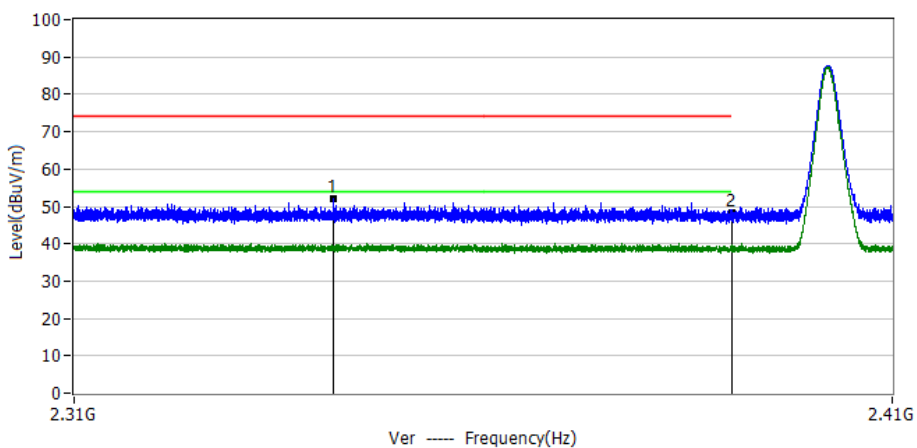

No.	Frequency	Reading dBuV	Factor dB/m	Level dBuV/m	Limit dBuV/m	Margin dB	Detector	Polar
1*	2.3413GHz	17.86	34.07	51.93	74.00	-22.07	PK	Ver
2*	2.3900GHz	14.55	33.95	48.50	74.00	-25.50	PK	Ver





Project: LGT23C058	Test Engineer: Dylan.shi
EUT: Bluetooth headphone	Temperature: 25.2°C
M/N: NC45	Humidity: 63%RH
Test Voltage: Battery	Test Data: 2023-04-03
Test Mode: DH5 2480	
Note:	

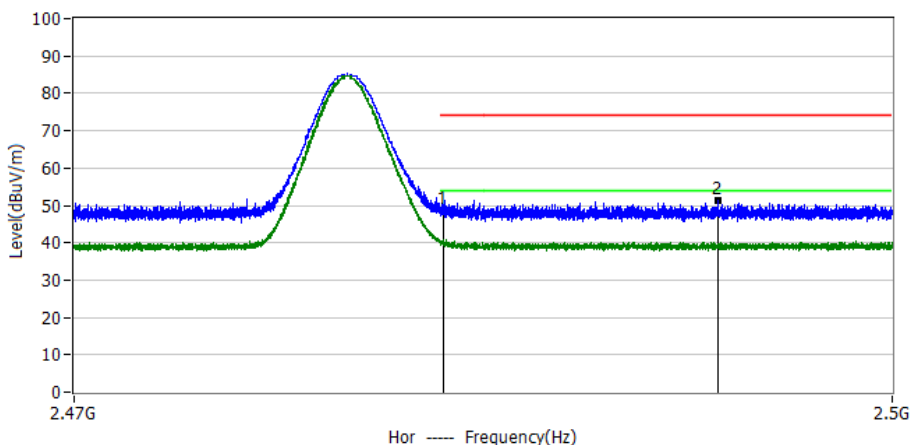

No.	Frequency	Reading dBuV	Factor dB/m	Level dBuV/m	Limit dBuV/m	Margin dB	Detector	Polar
1*	2.4835GHz	14.67	34.13	48.80	74.00	-25.20	PK	Hor
2*	2.4936GHz	17.02	34.15	51.17	74.00	-22.83	PK	Hor

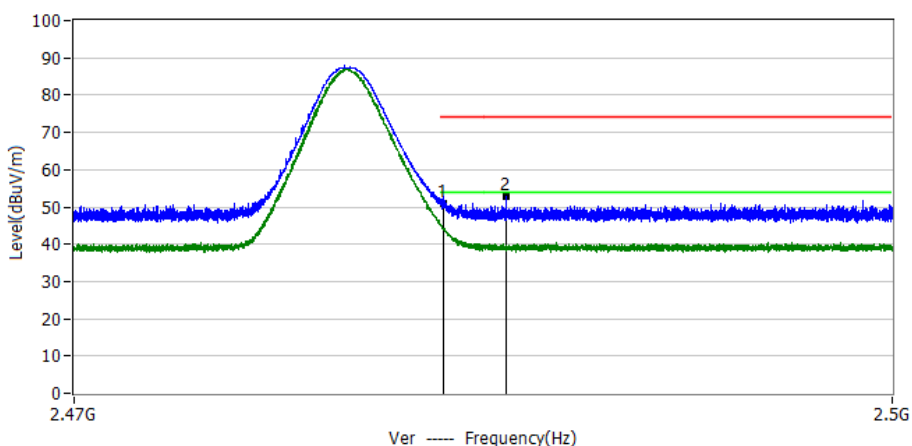

No.	Frequency	Reading dBuV	Factor dB/m	Level dBuV/m	Limit dBuV/m	Margin dB	Detector	Polar
1*	2.4835GHz	16.67	34.13	50.80	74.00	-23.20	PK	Ver
2*	2.4858GHz	18.82	34.13	52.95	74.00	-21.05	PK	Ver



## 4. CONDUCTED SPURIOUS & BAND EDGE EMISSION

### 4.1 LIMIT

In any 100kHz bandwidth outside the frequency band in which the spread spectrum or digitally modulated intentional radiator is operating, the radio frequency power that is produced by the intentional radiator shall be at least 20dB below that in the 100kHz bandwidth within the band that contains the highest level of the desired power, based on either an RF conducted or a radiated measurement.

### 4.2 TEST PROCEDURE

Spectrum Parameter	Setting
Detector	Peak
Start/Stop Frequency	30 MHz to 10th carrier harmonic
RB / VB (emission in restricted band)	100 KHz/300 KHz
Trace-Mode:	Max hold

For Band edge

Spectrum Parameter	Setting
Detector	Peak
Start/Stop Frequency	Lower Band Edge: 2300 – 2407 MHz Upper Band Edge: 2475 – 2500 MHz
RB / VB (emission in restricted band)	100 KHz/300 KHz
Trace-Mode:	Max hold

For Hopping Band edge

Spectrum Parameter	Setting
Detector	Peak
Start/Stop Frequency	Lower Band Edge: 2300– 2403 MHz Upper Band Edge: 2479 – 2500 MHz
RB / VB (emission in restricted band)	100 KHz/300 KHz
Trace-Mode:	Max hold



#### 4.3 TEST SETUP



The EUT is connected to the Spectrum Analyzer; the RF load attached to the EUT antenna terminal is 50Ohm; the path loss as the factor is calibrated to correct the reading. Tune the measurement with the spectrum analyzer's resolution bandwidth (RBW) = 100 kHz. In order to make an accurate measurement, the span is set to be greater than RBW.

#### 4.4 EUT OPERATION CONDITIONS

Please refer to section 3.1.4 of this report.

#### 4.5 TEST RESULTS

For the measurement records, refer to the appendix I.



## 5. NUMBER OF HOPPING CHANNEL

### 5.1 LIMIT

FCC Part 15.247, Subpart C RSS-247 Issue 2				
Section	Test Item	Limit	FrequencyRange (MHz)	Result
15.247 (a)(1)(iii)& RSS-247	Number of Hopping Channel	≥15	2400-2483.5	PASS

Spectrum Parameters	Setting
Attenuation	Auto
Span Frequency	> Operating FrequencyRange
RB	300KHz
VB	300KHz
Detector	Peak
Trace	Max Hold
Sweep Time	Auto

### 5.2 TEST PROCEDURE

- a. The EUT was directly connected to the spectrum analyzer and antenna output port as show in the block diagram below.
- b. Spectrum Setting: RBW= 300KHz, VBW=300KHz, Sweep time = Auto.

### 5.3 TEST SETUP



### 5.4 EUT OPERATION CONDITIONS

Please refer to section 3.1.4 of this report.

### 5.5 TEST RESULTS

For the measurement records · refer to the appendix I.



## 6. AVERAGE TIME OF OCCUPANCY

### 6.1 LIMIT

FCC Part 15.247, Subpart C RSS-247 Issue 2				
Section	Test Item	Limit	FrequencyRange (MHz)	Result
15.247 (a)(1)(iii)& RSS-247	Average Time of Occupancy	0.4sec	2400-2483.5	PASS

### 6.2 TEST PROCEDURE

- a. The transmitter output (antenna port) was connected to the spectrum analyzer.
- b. Set RBW =1MHz/VBW =3MHz.
- c. Use a video trigger with the trigger level set to enable triggering only on full pulses.
- d. Sweep Time is more than once pulse time.
- e. Set the center frequency on any frequency would be measure and set the frequency span to zero span.
- f. Measure the maximum time duration of one single pulse.
- g. Set the EUT for DH5, DH3 and DH1 packet transmitting.
- h. Measure the maximum time duration of one single pulse.
- i. DH5 Packet permit maximum  $1600 / 79 / 6 = 3.37$  hops per second in each channel (5 time slots RX, 1 time slot TX). So the number of pulses in the observation period of 31.6 seconds is  $3.37 \times 31.6 = 106.6$ .
- j. DH3 Packet permit maximum  $1600 / 79 / 4 = 5.06$  hops per second in each channel (3 time slots RX, 1 time slot TX). So the number of pulses in the observation period of 31.6 seconds is  $5.06 \times 31.6 = 160$ .
- k. DH1 Packet permit maximum  $1600 / 79 / 2 = 10.12$  hops per second in each channel (1 time slot RX, 1 time slot TX). So the number of pulses in the observation period of 31.6 seconds is  $10.12 \times 31.6 = 320$ .

### 6.3 TEST SETUP



### 6.4 EUT OPERATION CONDITIONS

Please refer to section 3.1.4 of this report.

### 6.5 TEST RESULTS

For the measurement records refer to the appendix I.



## 7. HOPPING CHANNEL SEPARATION MEASUREMENT

### 7.1 LIMIT

Frequency hopping systems shall have hopping channel carrier frequencies separated by a minimum of 25 kHz or the 20 dB bandwidth of the hopping channel, whichever is greater. Alternatively, frequency hopping systems operating in the 2400-2483.5 MHz band may have hopping channel carrier frequencies that are separated by 25 kHz or two-thirds of the 20 dB bandwidth of the hopping channel, whichever is greater, provided the systems operate with an output power no greater than 125 mW.

Spectrum Parameter	Setting
Attenuation	Auto
Span Frequency	> 20 dB Bandwidth or Channel Separation
RB	30 kHz (20dB Bandwidth) / 30 kHz (Channel Separation)
VB	100 kHz (20dB Bandwidth) / 100 kHz (Channel Separation)
Detector	Peak
Trace	Max Hold
Sweep Time	Auto

### 7.2 TEST PROCEDURE

- The transmitter output (antenna port) was connected to the spectrum analyser in peak hold mode.
- The resolution bandwidth of 30 kHz and the video bandwidth of 100 kHz were utilised for 20 dB bandwidth measurement.
- The resolution bandwidth of 30 kHz and the video bandwidth of 100 kHz were utilised for channel separation measurement.

### 7.3 TEST SETUP



### 7.4 EUT OPERATION CONDITIONS

The EUT was programmed to be in continuously transmitting mode.

### 7.5 TEST RESULTS

For the measurement records refer to the appendix I.



## 8. BANDWIDTH TEST

### 8.1 LIMIT

FCC Part15 15.247, Subpart C RSS-247 Issue 2				
Section	Test Item	Limit	FrequencyRange (MHz)	Result
15.247 (a)(1)& RSS-247	Bandwidth	N/A	2400-2483.5	PASS

Spectrum Parameter	Setting
Attenuation	Auto
Span Frequency	> Measurement Bandwidth or Channel Separation
RB	30 kHz (20dB Bandwidth) / 30 kHz (Channel Separation)
VB	100 kHz (20dB Bandwidth) / 100 kHz (Channel Separation)
Detector	Peak
Trace	Max Hold
Sweep Time	Auto

### 8.2 TEST PROCEDURE

- a. The EUT was directly connected to the spectrum analyzer and antenna output port as show in the block diagram below.
- b. Spectrum Setting: RBW= 30KHz, VBW=100KHz, Sweep time = Auto.

### 8.3 TEST SETUP



### 8.4 EUT OPERATION CONDITIONS

Please refer to section 3.1.4 of this report.

### 8.5 TEST RESULTS

For the measurement records , refer to the appendix I.



## 9. OUTPUT POWER TEST

### 9.1 LIMIT

FCC Part 15.247, Subpart C RSS-247 Issue 2				
Section	Test Item	Limit	Frequency Range (MHz)	Result
15.247 (a)(1)&(b)(1) RSS-247	Output Power	1 W or 0.125W	2400-2483.5	PASS
		if channel separation > 2/3 bandwidth provided the systems operate with an output power no greater than 125 mW (20.97 dBm)		
RSS-247	EIRP	4W	2400-2483.5	PASS

### 9.2 TEST PROCEDURE

This is an RF-conducted test to evaluate maximum peak output power. Use a direct connection between the antenna port of the unlicensed wireless device and the spectrum analyzer, through suitable attenuation. The hopping shall be disabled for this test:

a) Use the following spectrum analyzer settings:

- 1) Span: Approximately five times the 20 dB bandwidth, centered on a hopping channel.
- 2) RBW > 20 dB bandwidth of the emission being measured.
- 3) VBW ≥ RBW.
- 4) Sweep: Auto.
- 5) Detector function: Peak.
- 6) Trace: Max hold.

b) Allow trace to stabilize.

c) Use the marker-to-peak function to set the marker to the peak of the emission.

d) The indicated level is the peak output power, after any corrections for external attenuators and cables.

e) A plot of the test results and setup description shall be included in the test report.

NOTE—A peak responding power meter may be used, where the power meter and sensor system video bandwidth is greater than the occupied bandwidth of the unlicensed wireless device, rather than a spectrum analyzer.

PKPM1 Peak power meter method:

The maximum peak conducted output power may be measured using a broadband peak RF power meter. The power meter shall have a video bandwidth that is greater than or equal to the DSS bandwidth and shall use a fast-responding diode detector.

### 9.3 TEST SETUP

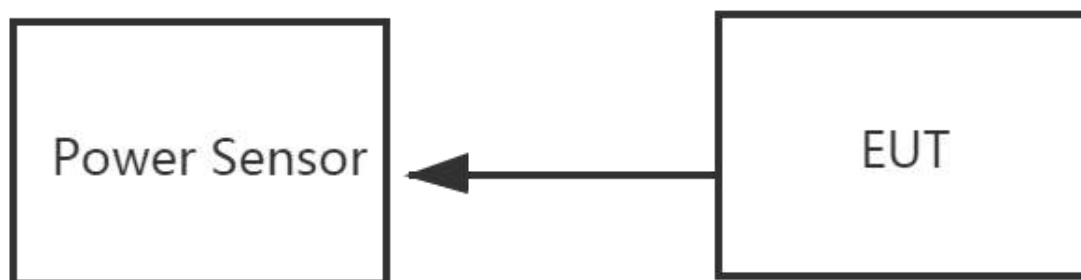





#### 9.4 EUT OPERATION CONDITIONS

Please refer to section 3.1.4 of this report.

#### 9.5 TEST RESULTS

For the measurement records refer to the appendix I.



## 10. ANTENNA REQUIREMENT

### 10.1 STANDARD REQUIREMENT

Part 15.203&RSS-Gen Issue 5 requirement: For intentional device, according to 15.203: an intentional radiator shall be designed to ensure that no antenna other than that furnished by the responsible party shall be used with the device.

### 10.2 EUT ANTENNA

The EUT antenna is chip antenna. It comply with the standard requirement.



## APPENDIX I: TEST RESULTS

### Duty Cycle

Condition	Mode	Frequency (MHz)	Antenna	Duty Cycle (%)	Correction Factor (dB)	1/T (kHz)
NVNT	1-DH5	2402	Ant1	46.27	3.35	0.35
NVNT	1-DH5	2441	Ant1	46.29	3.35	0.35
NVNT	1-DH5	2480	Ant1	46.29	3.35	0.35
NVNT	2-DH5	2402	Ant1	46.37	3.34	0.35
NVNT	2-DH5	2441	Ant1	46.37	3.34	0.35
NVNT	2-DH5	2480	Ant1	46.37	3.34	0.35
NVNT	3-DH5	2402	Ant1	46.41	3.33	0.34
NVNT	3-DH5	2441	Ant1	46.37	3.34	0.35
NVNT	3-DH5	2480	Ant1	46.37	3.34	0.35

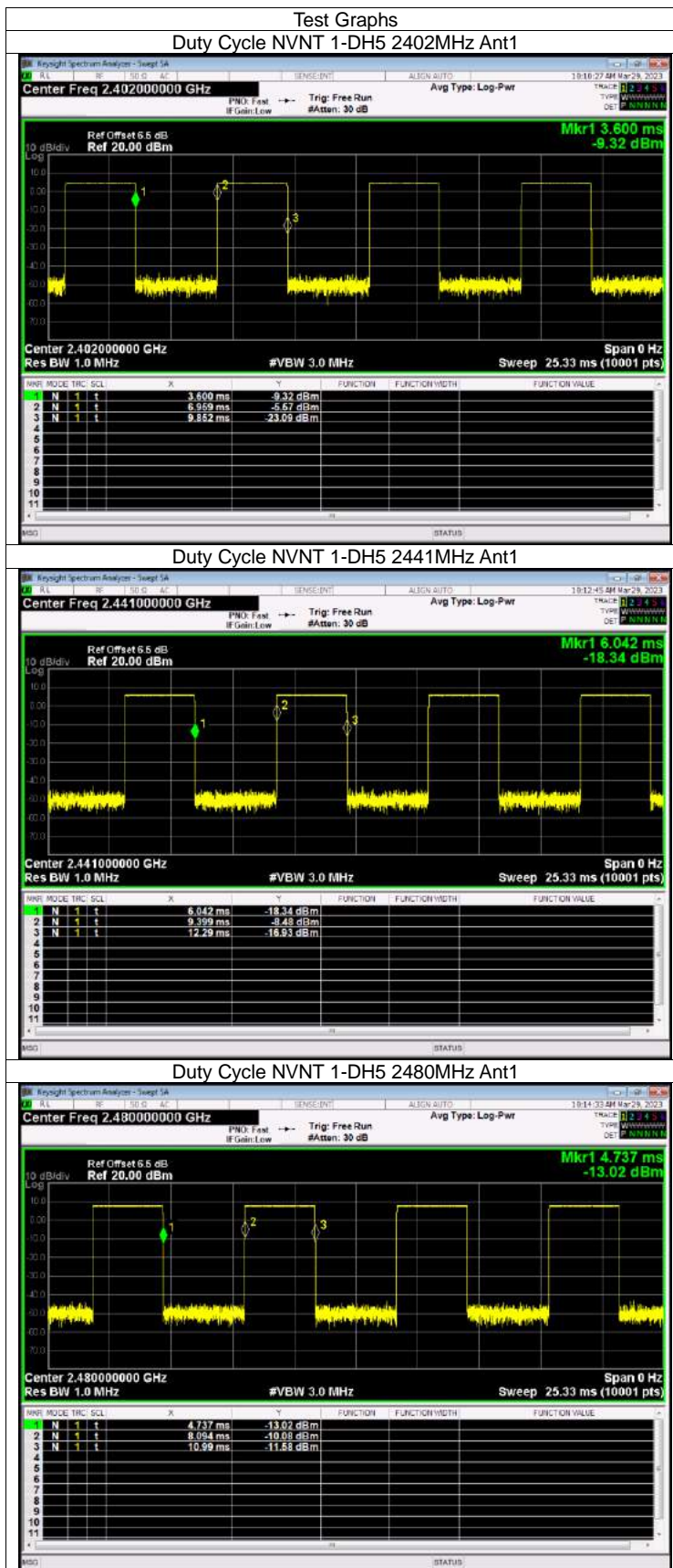

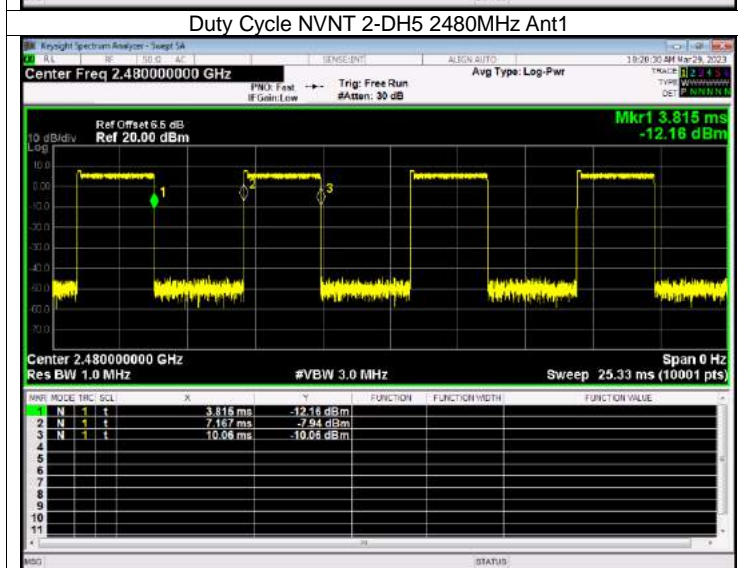
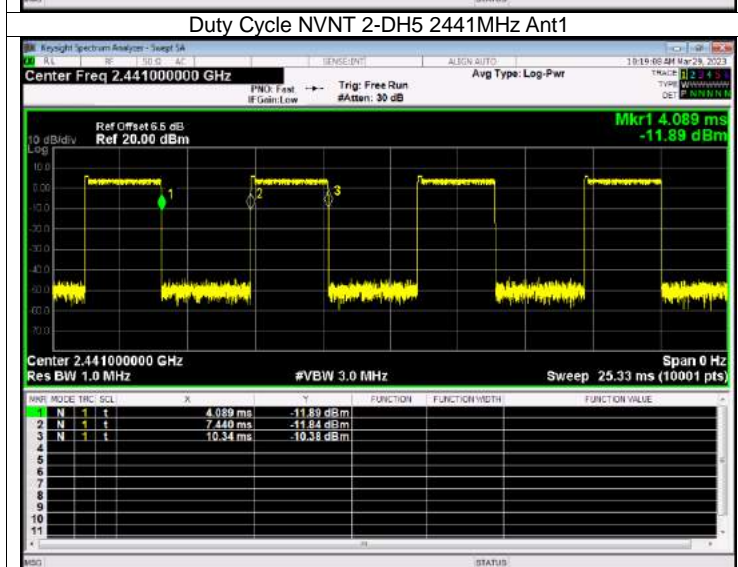
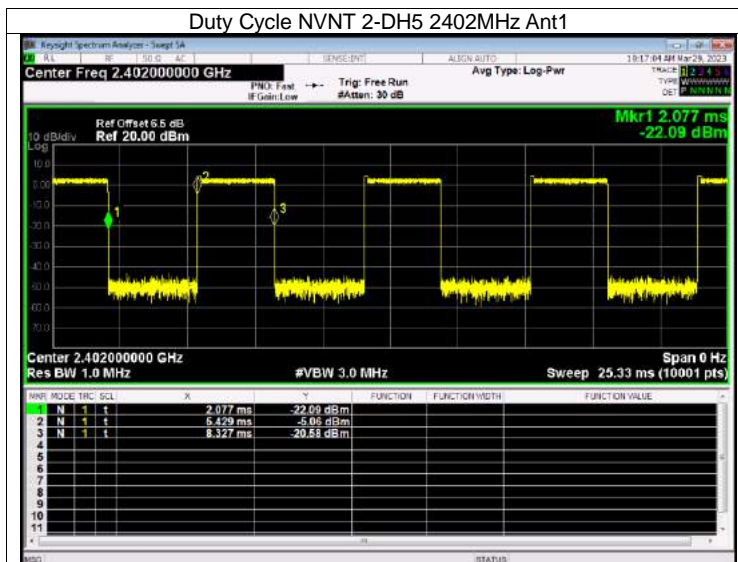

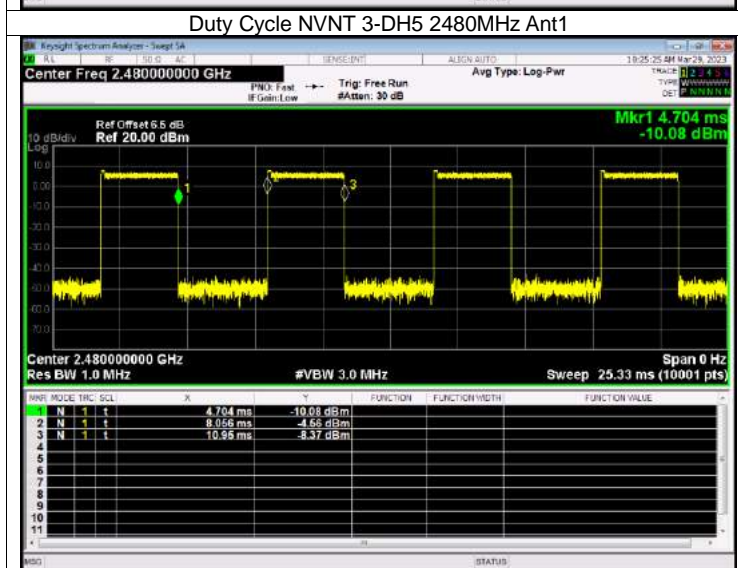
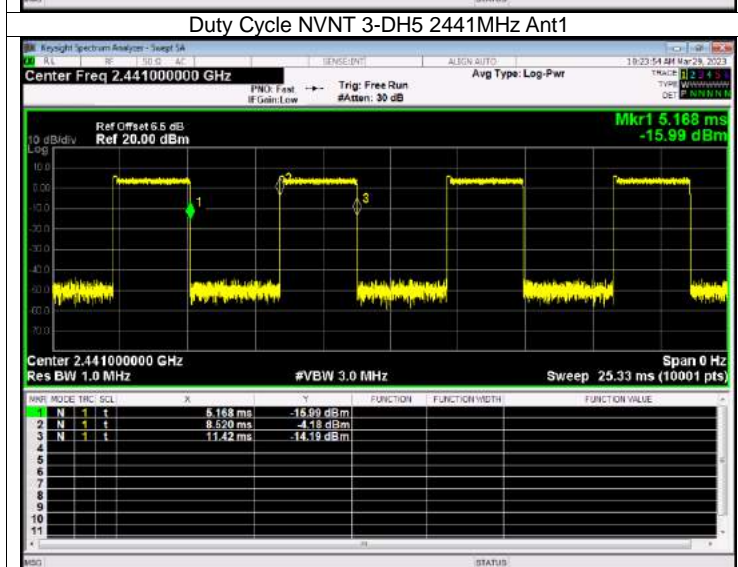
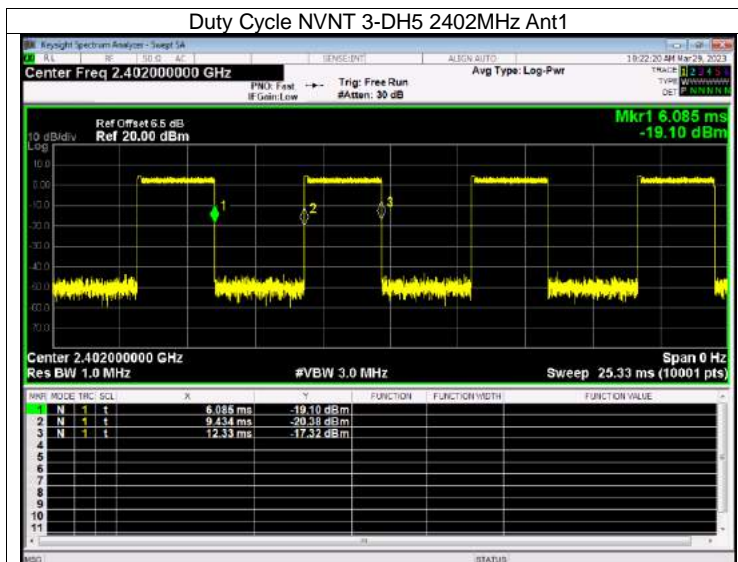



## Maximum Peak Conducted Output Power

Mode	Frequency (MHz)	Conducted Power (dBm)	Limit (dBm)	ANT GAIN(dBi)	EIRP (dBm)	EIRP Limit(dBm)	Verdict
1-DH5	2402	4.60	21	3.59	8.19	36	Pass
1-DH5	2441	5.78	21	3.59	9.37	36	Pass
1-DH5	2480	7.69	21	3.59	11.3	36	Pass
2-DH5	2402	4.56	21	3.59	8.15	36	Pass
2-DH5	2441	5.80	21	3.59	9.39	36	Pass
2-DH5	2480	6.83	21	3.59	10.4	36	Pass
3-DH5	2402	4.58	21	3.59	8.17	36	Pass
3-DH5	2441	5.81	21	3.59	9.4	36	Pass
3-DH5	2480	7.66	21	3.59	11.3	36	Pass



## -20dB Bandwidth

Condition	Mode	Frequency (MHz)	Antenna	-20 dB Bandwidth (MHz)	Verdict
NVNT	1-DH5	2402	Ant1	0.945	Pass
NVNT	1-DH5	2441	Ant1	0.899	Pass
NVNT	1-DH5	2480	Ant1	0.957	Pass
NVNT	2-DH5	2402	Ant1	1.235	Pass
NVNT	2-DH5	2441	Ant1	1.257	Pass
NVNT	2-DH5	2480	Ant1	1.254	Pass
NVNT	3-DH5	2402	Ant1	1.239	Pass
NVNT	3-DH5	2441	Ant1	1.253	Pass
NVNT	3-DH5	2480	Ant1	1.252	Pass





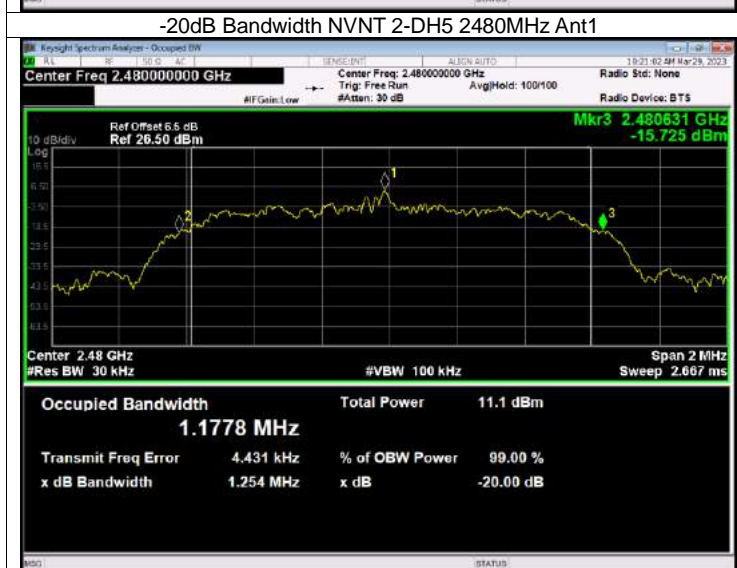
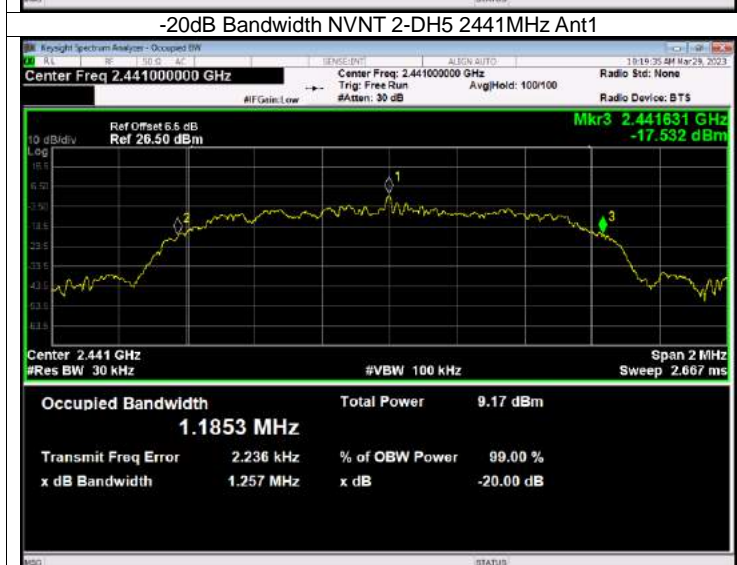
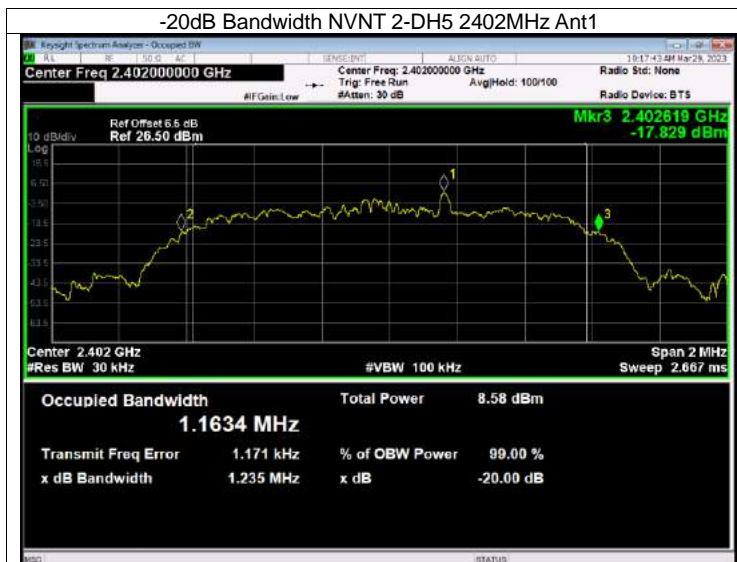

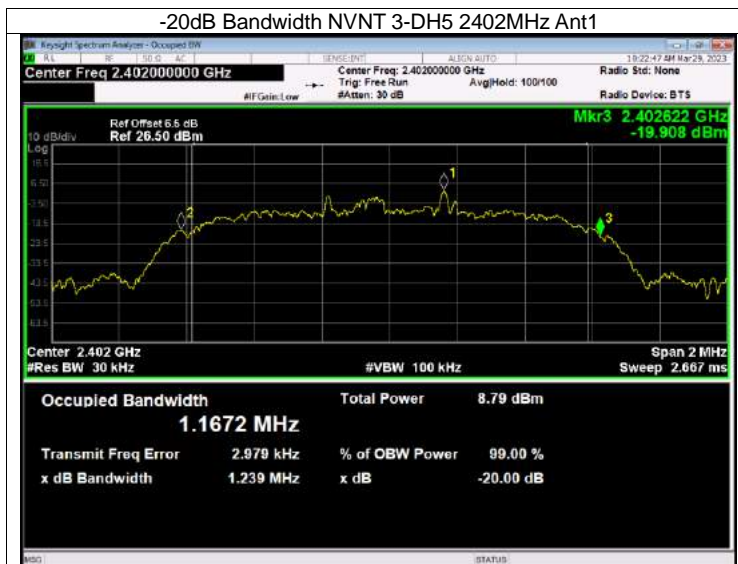



## Occupied Channel Bandwidth

Condition	Mode	Frequency (MHz)	Antenna	99% OBW (MHz)
NVNT	1-DH5	2402	Ant1	0.866
NVNT	1-DH5	2441	Ant1	0.870
NVNT	1-DH5	2480	Ant1	0.871
NVNT	2-DH5	2402	Ant1	1.178
NVNT	2-DH5	2441	Ant1	1.171
NVNT	2-DH5	2480	Ant1	1.165
NVNT	3-DH5	2402	Ant1	1.175
NVNT	3-DH5	2441	Ant1	1.162
NVNT	3-DH5	2480	Ant1	1.150



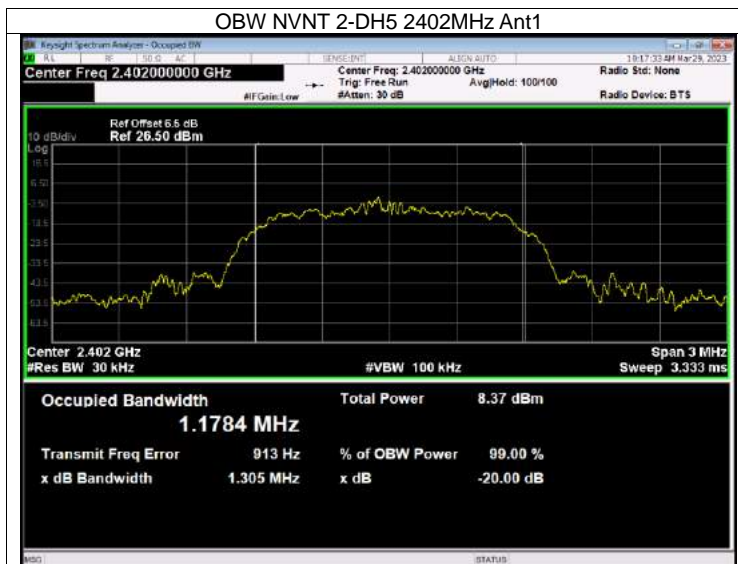





## Carrier Frequencies Separation

Condition	Mode	Antenna	Hopping Freq1 (MHz)	Hopping Freq2 (MHz)	HFS (MHz)	Limit (MHz)	Verdict
NVNT	1-DH5	Ant1	2401.98	2402.968	0.988	0.630	Pass
NVNT	1-DH5	Ant1	2441.06	2441.992	0.932	0.599	Pass
NVNT	1-DH5	Ant1	2478.994	2480.012	1.018	0.638	Pass
NVNT	2-DH5	Ant1	2401.978	2402.954	0.976	0.823	Pass
NVNT	2-DH5	Ant1	2440.966	2441.916	0.950	0.838	Pass
NVNT	2-DH5	Ant1	2479.08	2479.948	0.868	0.836	Pass
NVNT	3-DH5	Ant1	2402.018	2403.010	0.992	0.826	Pass
NVNT	3-DH5	Ant1	2441.074	2441.918	0.844	0.835	Pass
NVNT	3-DH5	Ant1	2478.942	2479.928	0.986	0.835	Pass





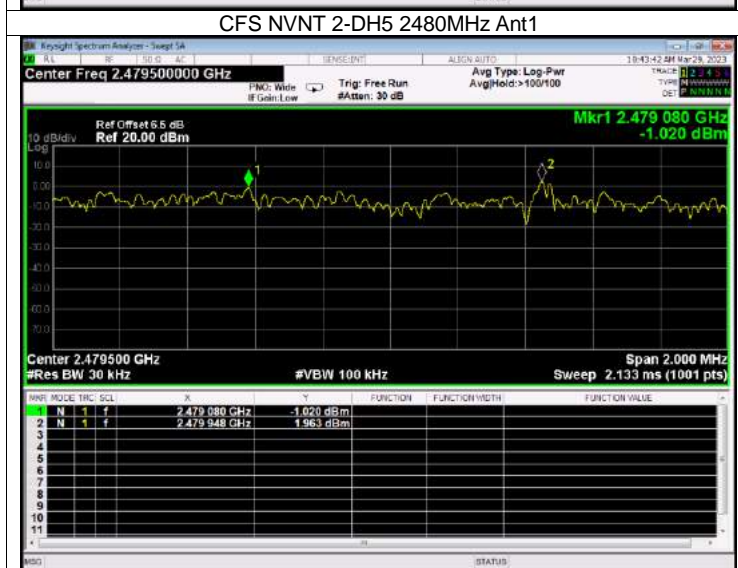
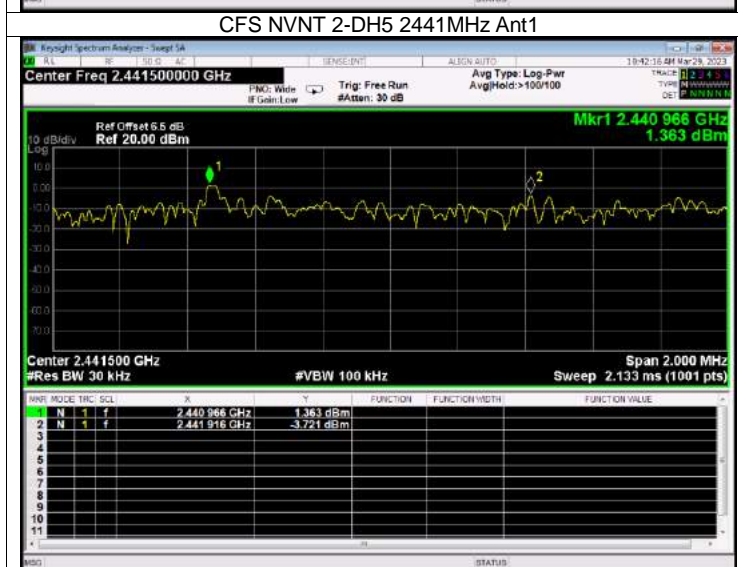
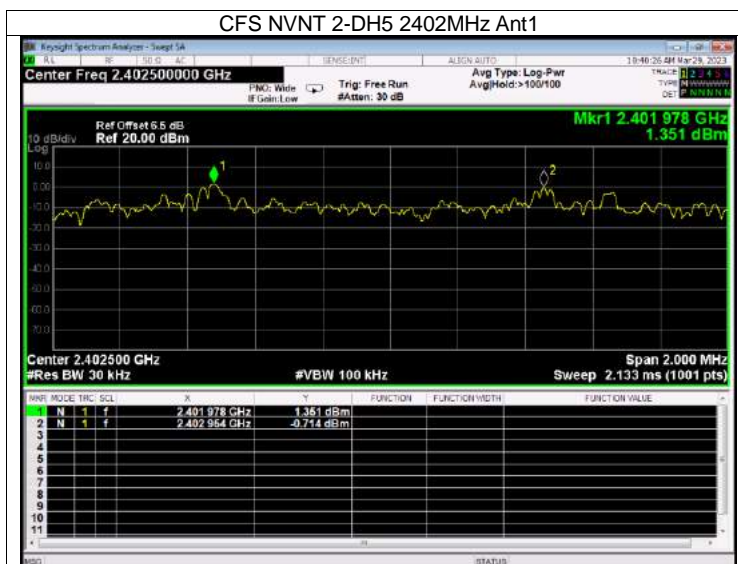

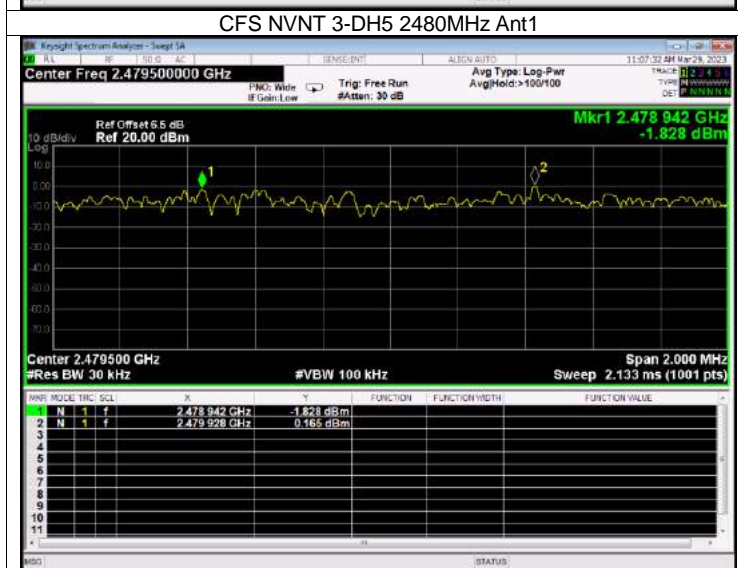
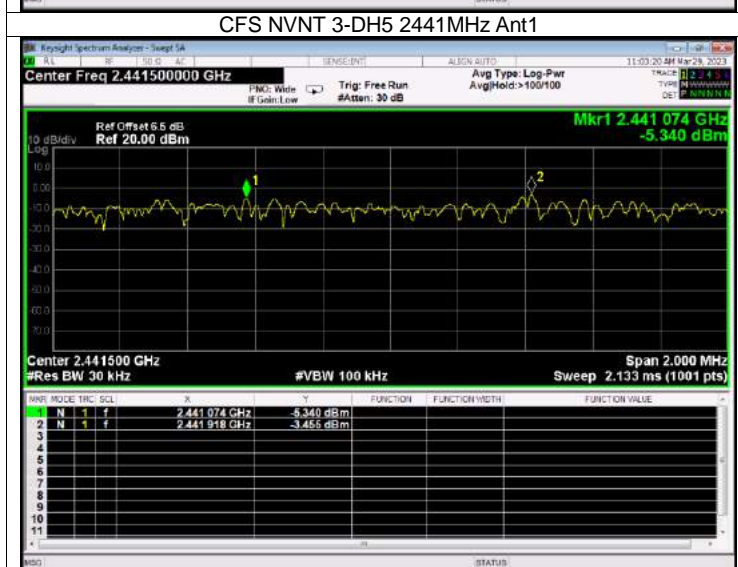
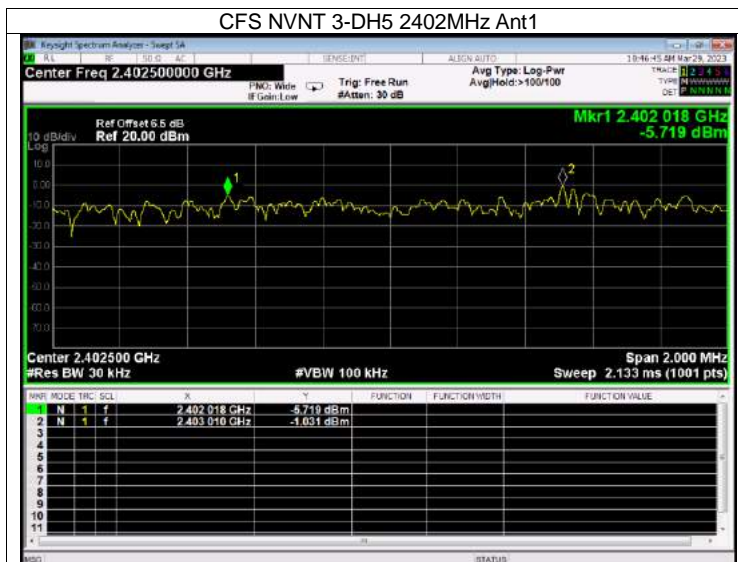



## Band Edge

Condition	Mode	Frequency (MHz)	Antenna	Hopping Mode	Max Value (dBc)	Limit (dBc)	Verdict
NVNT	1-DH5	2402	Ant1	No-Hopping	-53.97	-20	Pass
NVNT	1-DH5	2480	Ant1	No-Hopping	-57.75	-20	Pass
NVNT	2-DH5	2402	Ant1	No-Hopping	-53.46	-20	Pass
NVNT	2-DH5	2480	Ant1	No-Hopping	-56.12	-20	Pass
NVNT	3-DH5	2402	Ant1	No-Hopping	-45.82	-20	Pass
NVNT	3-DH5	2480	Ant1	No-Hopping	-58.81	-20	Pass

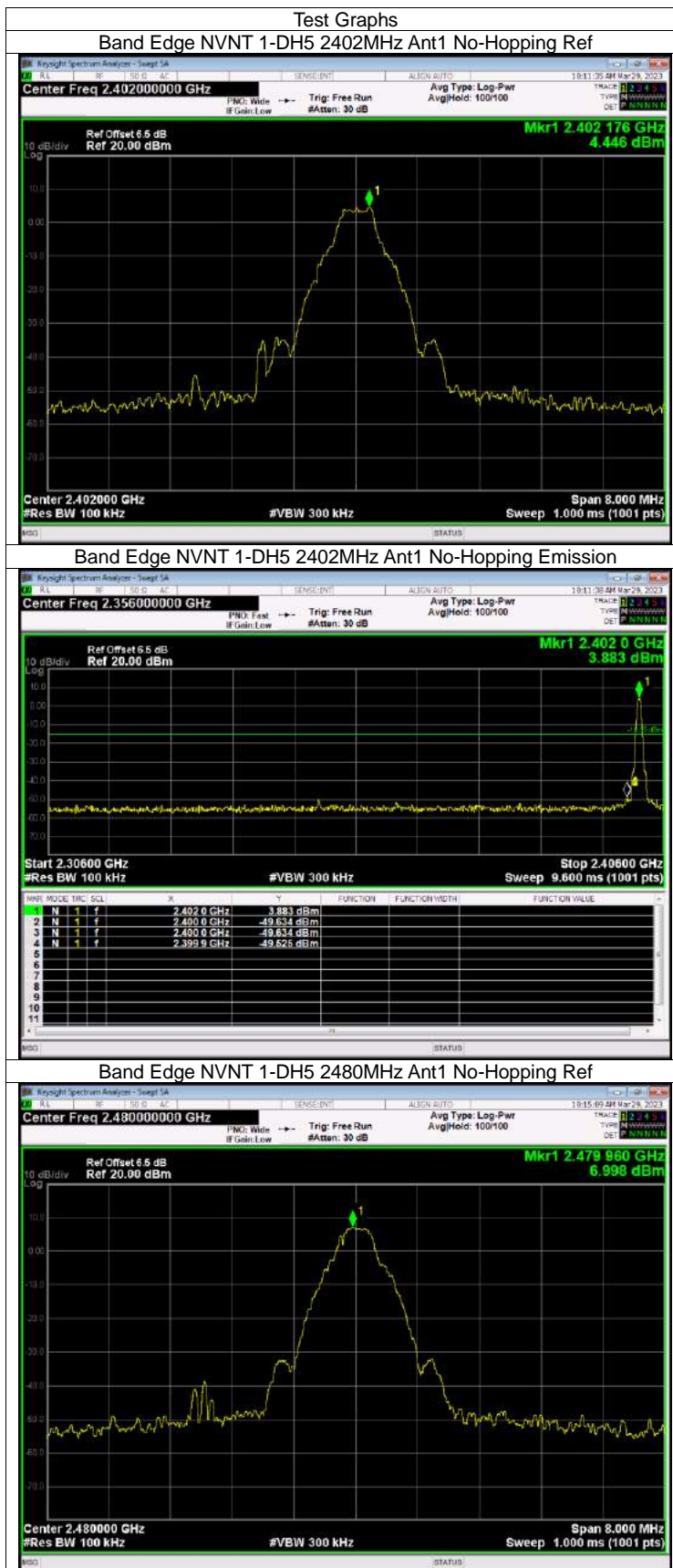

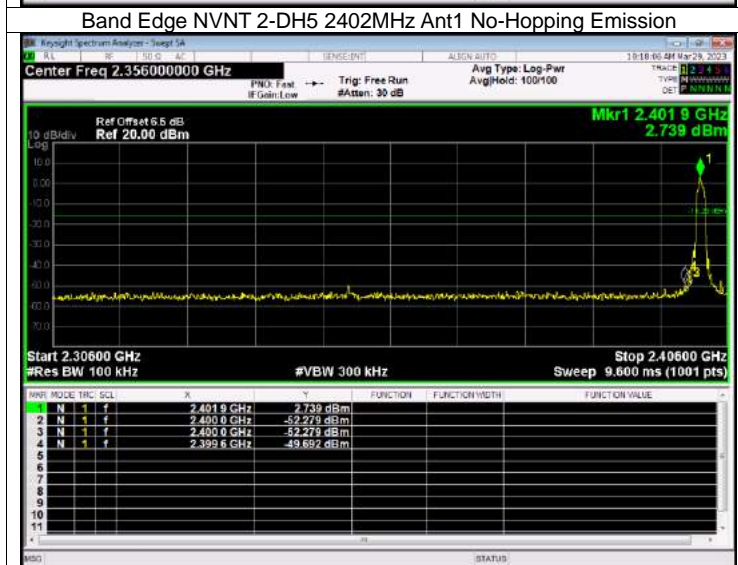
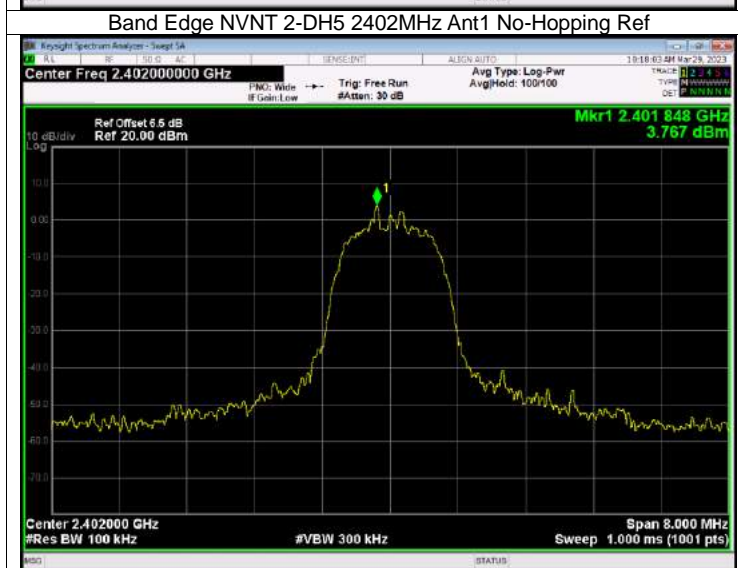
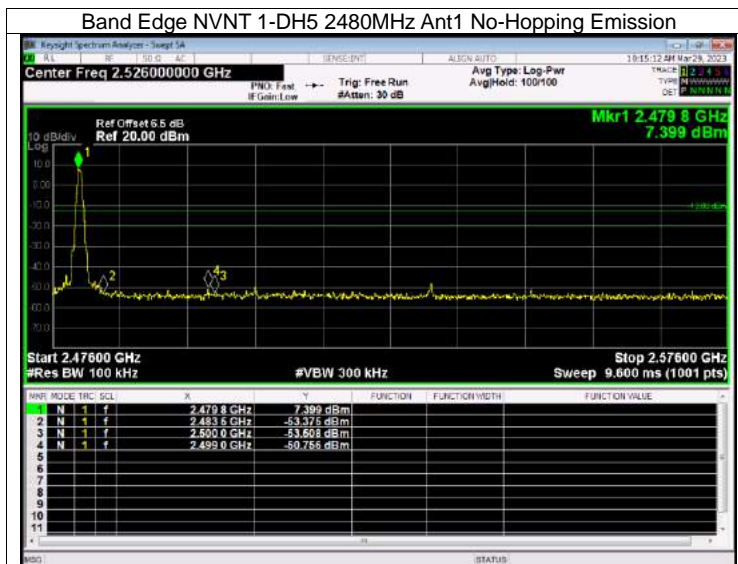

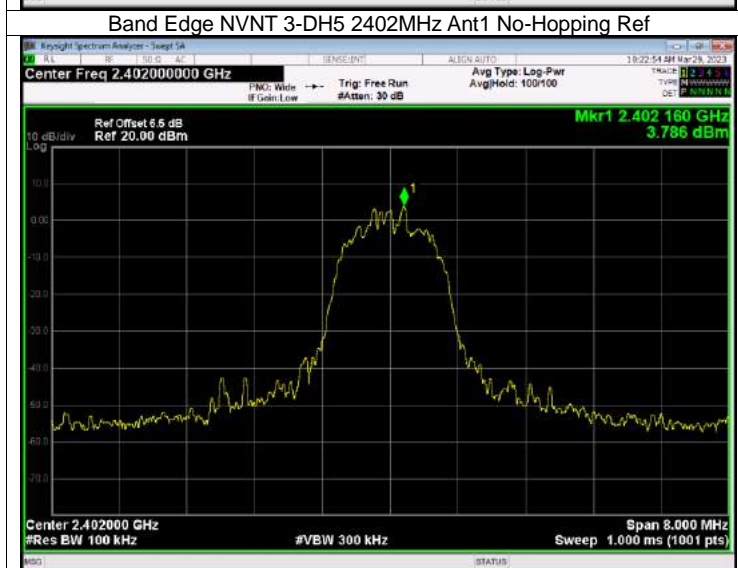
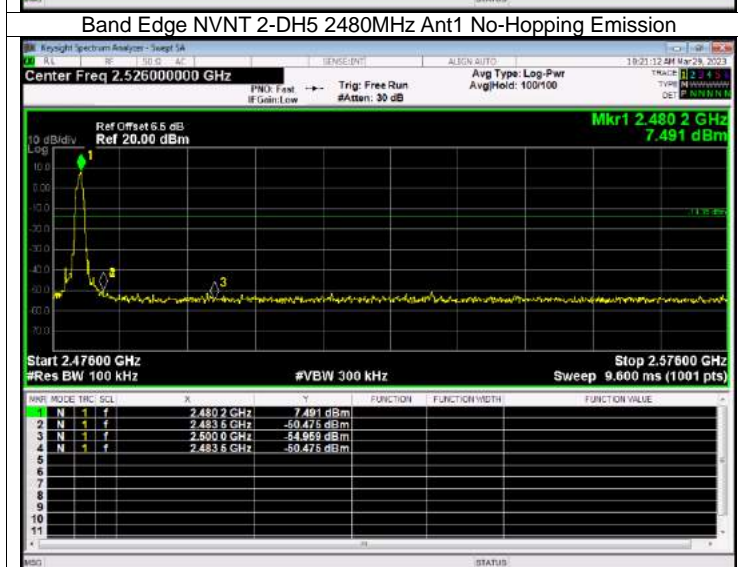
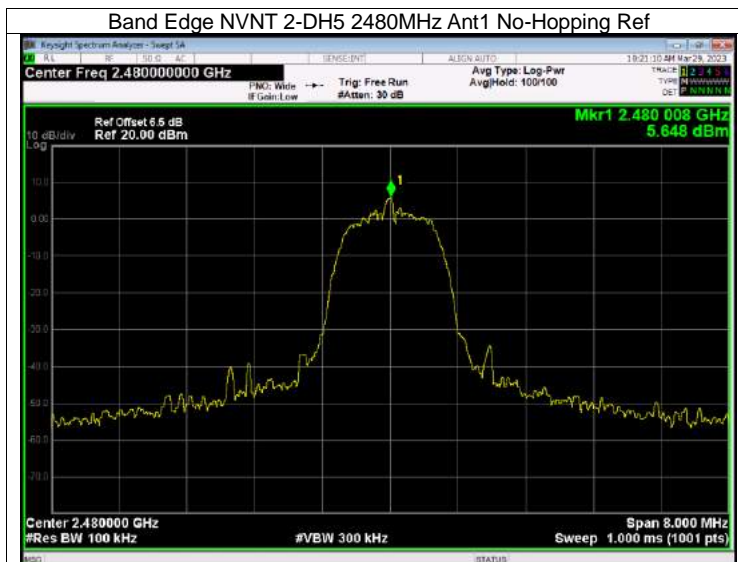

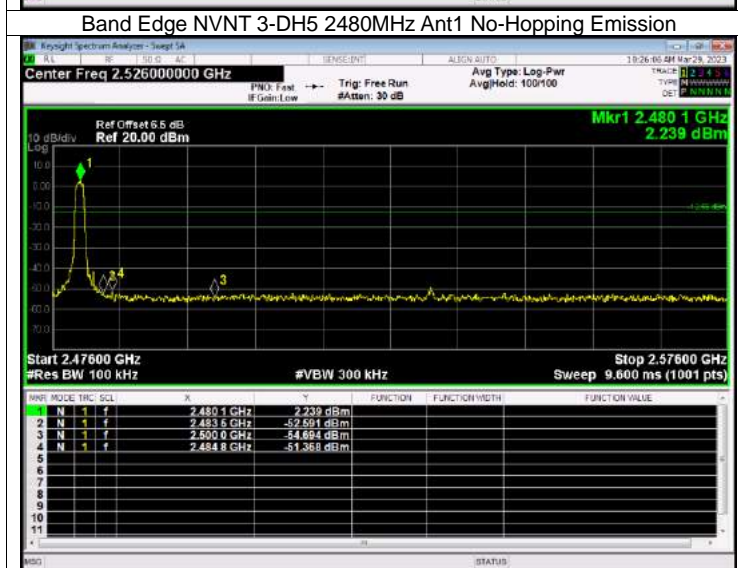
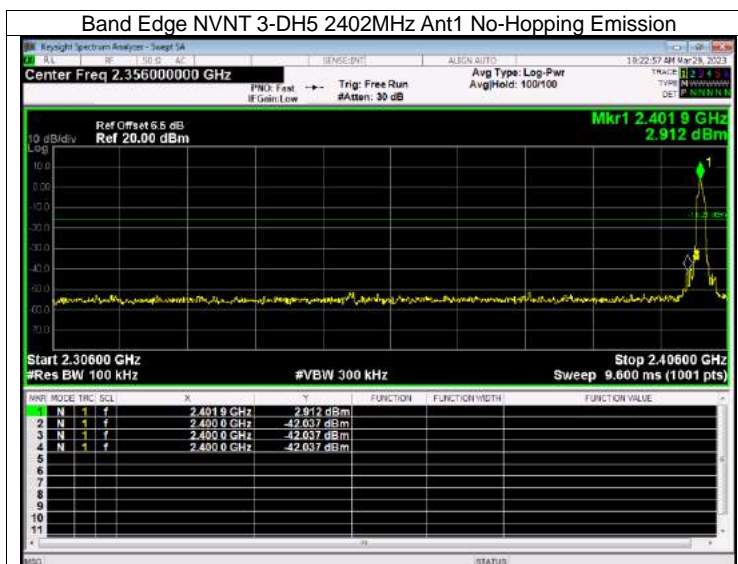





## Band Edge (Hopping)

Condition	Mode	Frequency (MHz)	Antenna	Hopping Mode	Max Value (dBc)	Limit (dBc)	Verdict
NVNT	1-DH5	2402	Ant1	Hopping	-52.95	-20	Pass
NVNT	1-DH5	2480	Ant1	Hopping	-54.42	-20	Pass
NVNT	2-DH5	2402	Ant1	Hopping	-52.31	-20	Pass
NVNT	2-DH5	2480	Ant1	Hopping	-56.79	-20	Pass
NVNT	3-DH5	2402	Ant1	Hopping	-52.46	-20	Pass
NVNT	3-DH5	2480	Ant1	Hopping	-57.13	-20	Pass

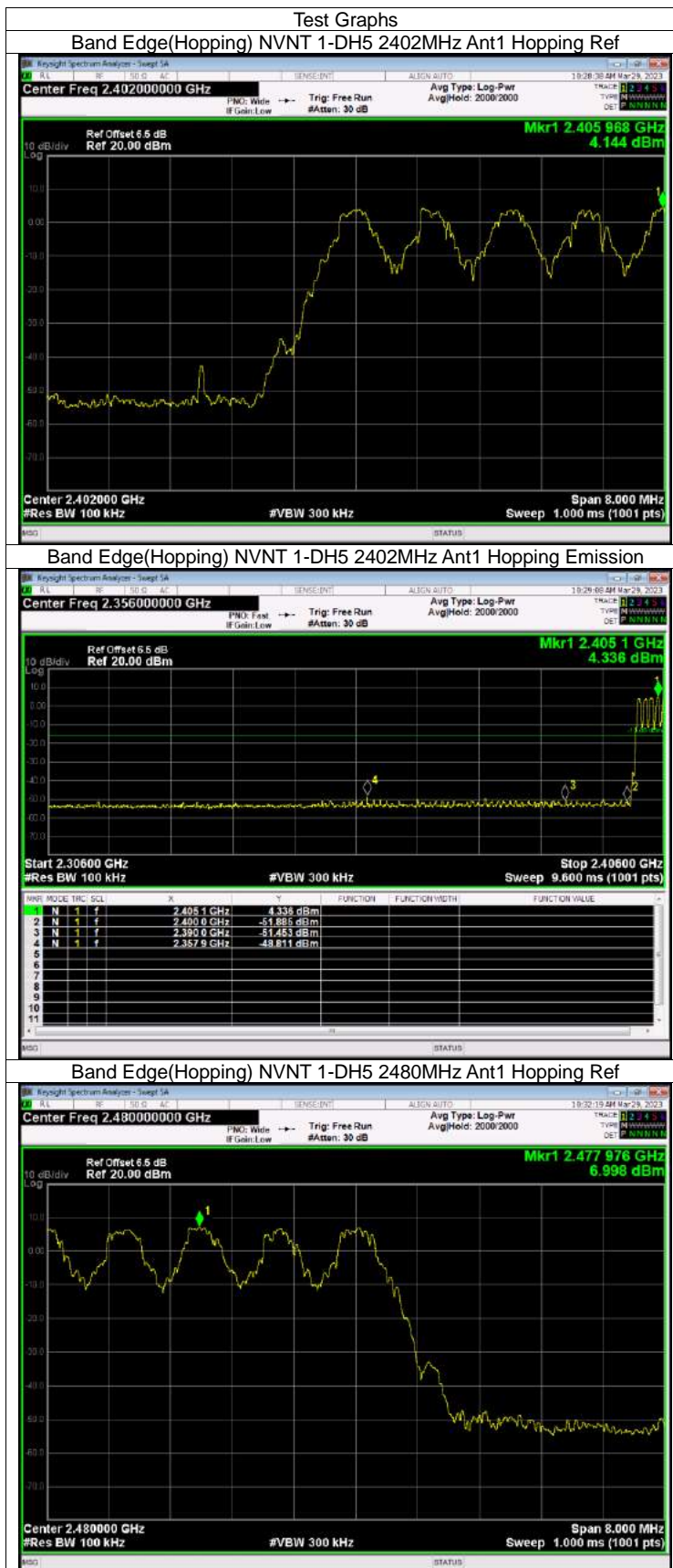

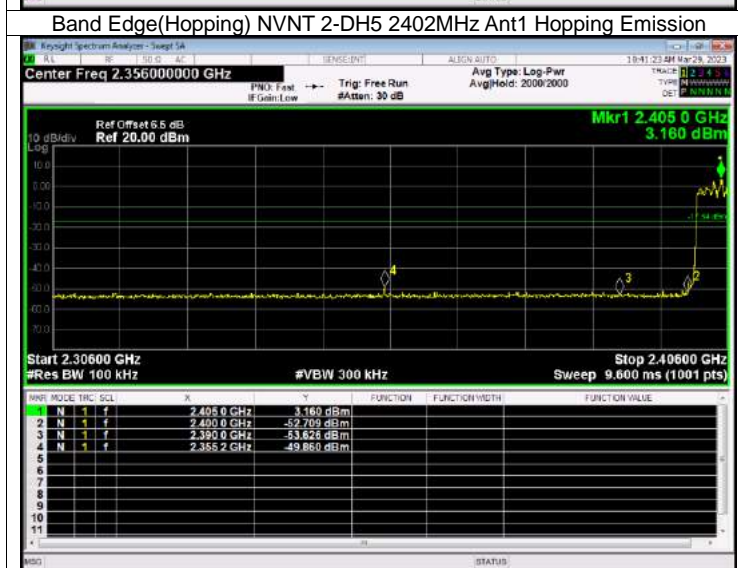
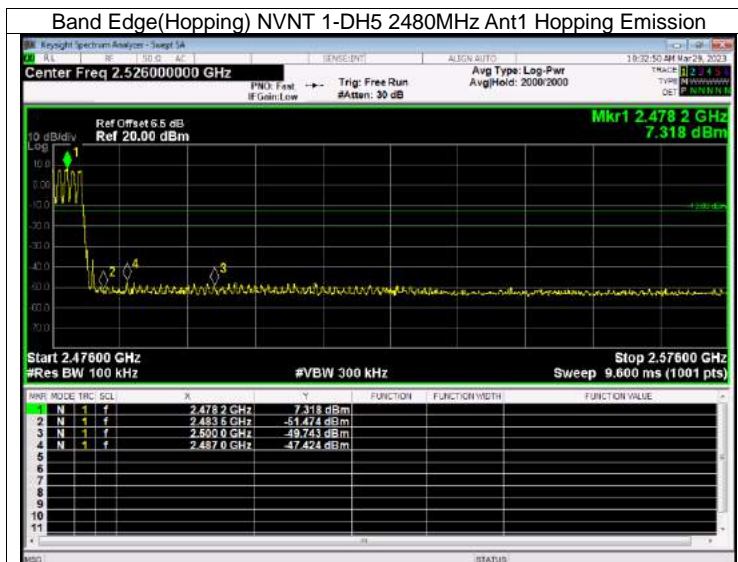

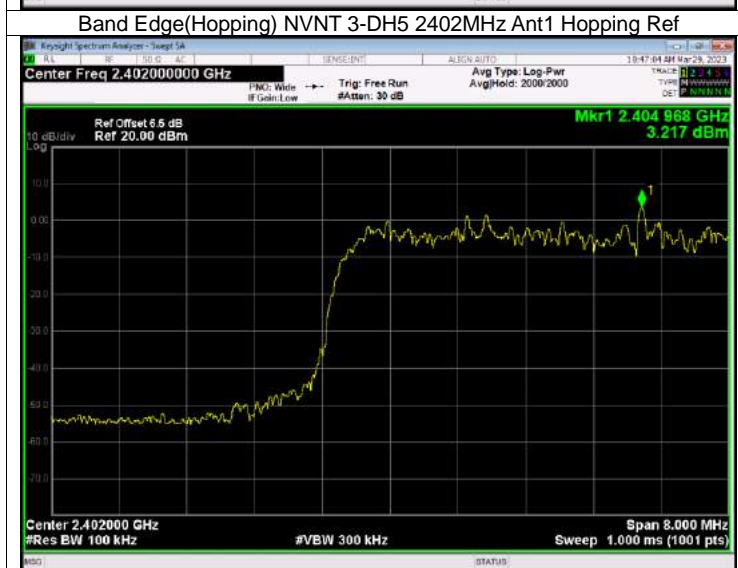
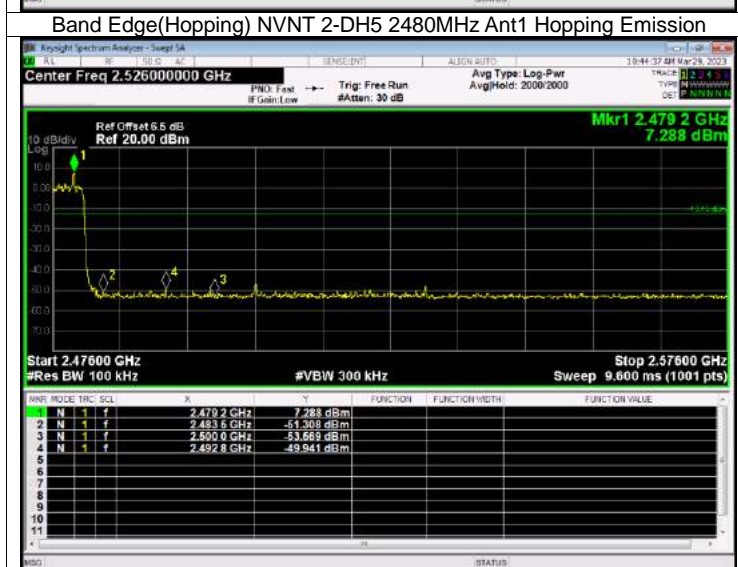

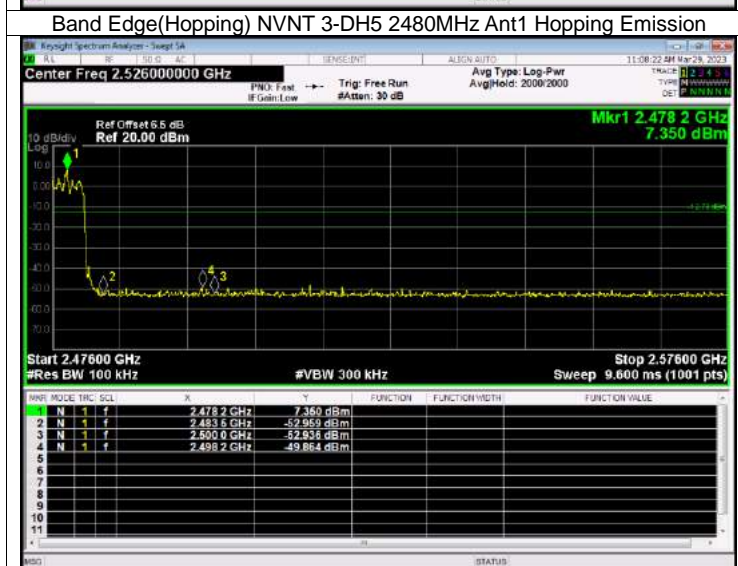
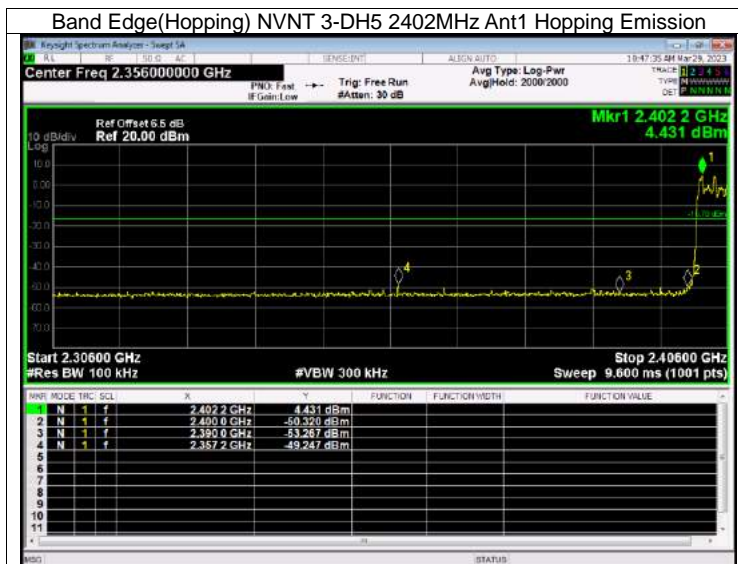



## Conducted RF Spurious Emission

Condition	Mode	Frequency (MHz)	Antenna	Max Value (dBc)	Limit (dBc)	Verdict
NVNT	1-DH5	2402	Ant1	-53.21	-20	Pass
NVNT	1-DH5	2441	Ant1	-55.24	-20	Pass
NVNT	1-DH5	2480	Ant1	-57.4	-20	Pass
NVNT	2-DH5	2402	Ant1	-53.7	-20	Pass
NVNT	2-DH5	2441	Ant1	-55.25	-20	Pass
NVNT	2-DH5	2480	Ant1	-55.87	-20	Pass
NVNT	3-DH5	2402	Ant1	-52.94	-20	Pass
NVNT	3-DH5	2441	Ant1	-54.68	-20	Pass
NVNT	3-DH5	2480	Ant1	-56.74	-20	Pass

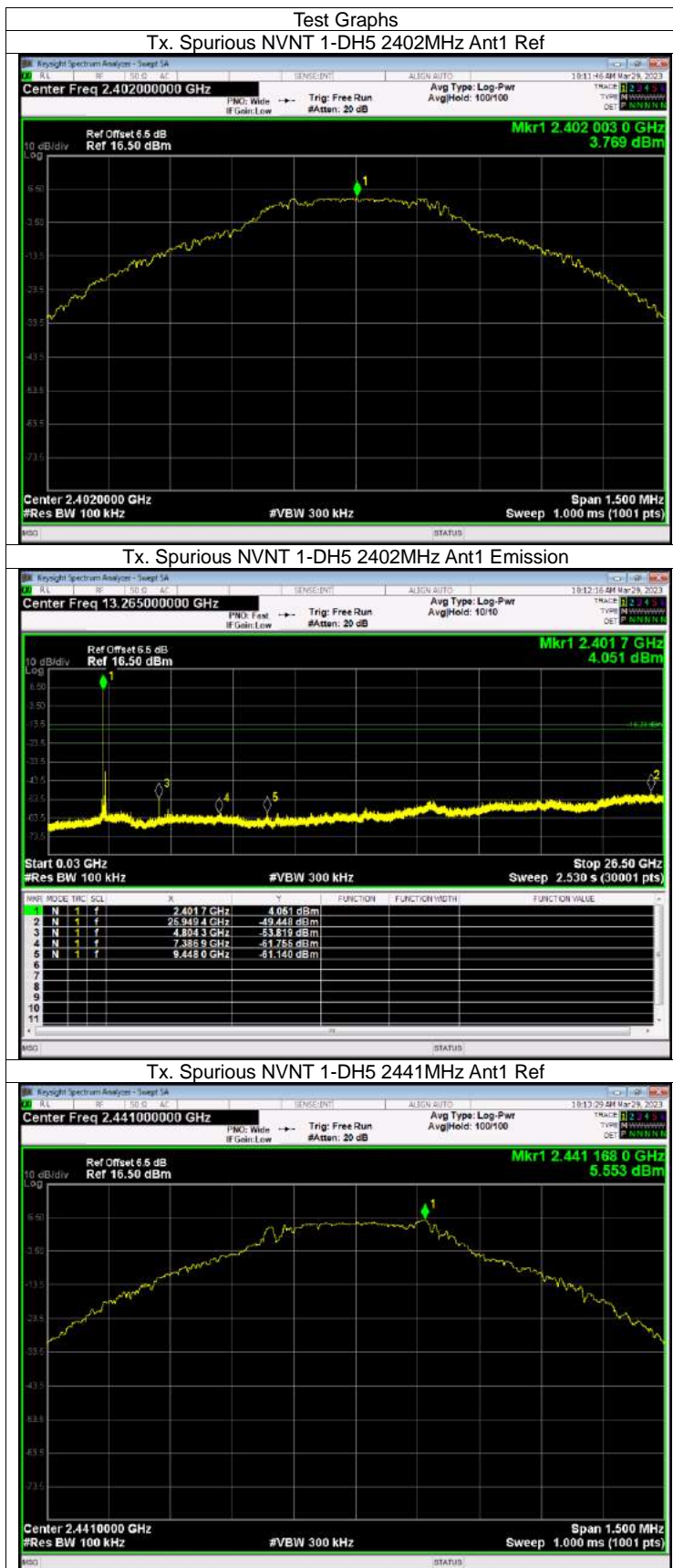

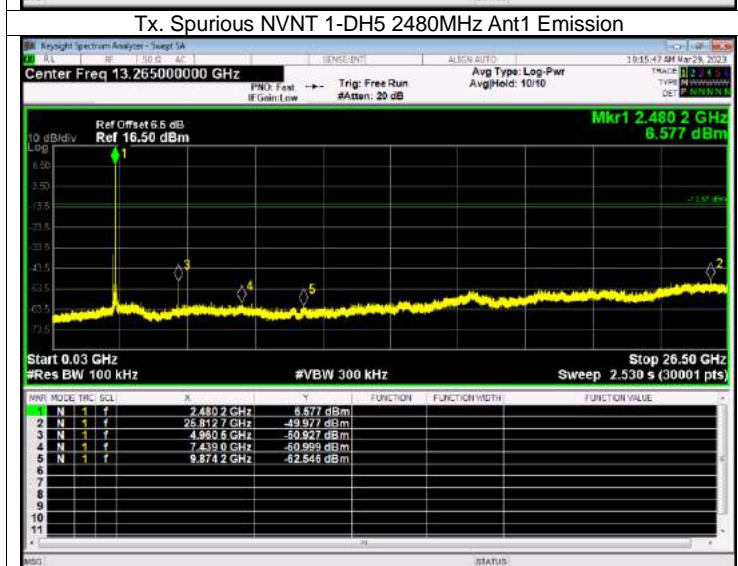
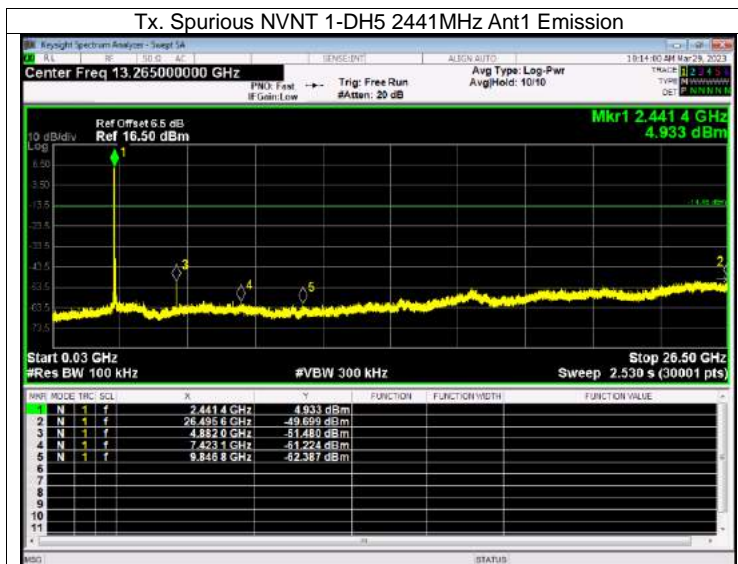



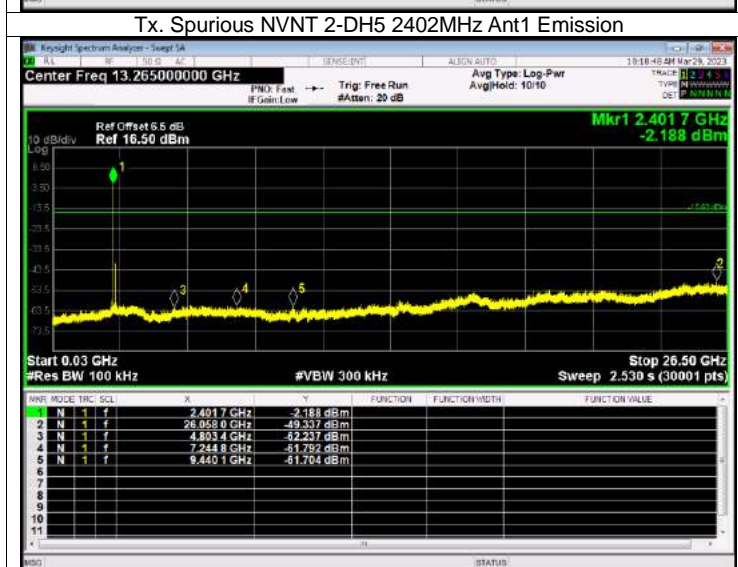

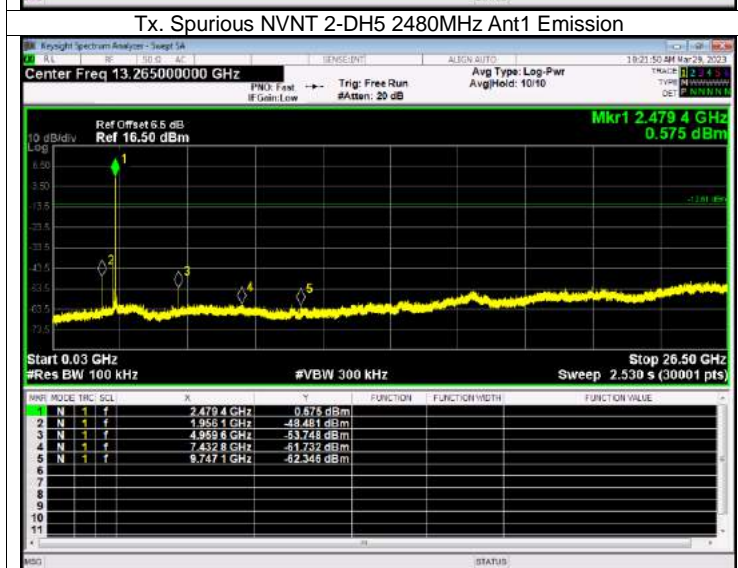
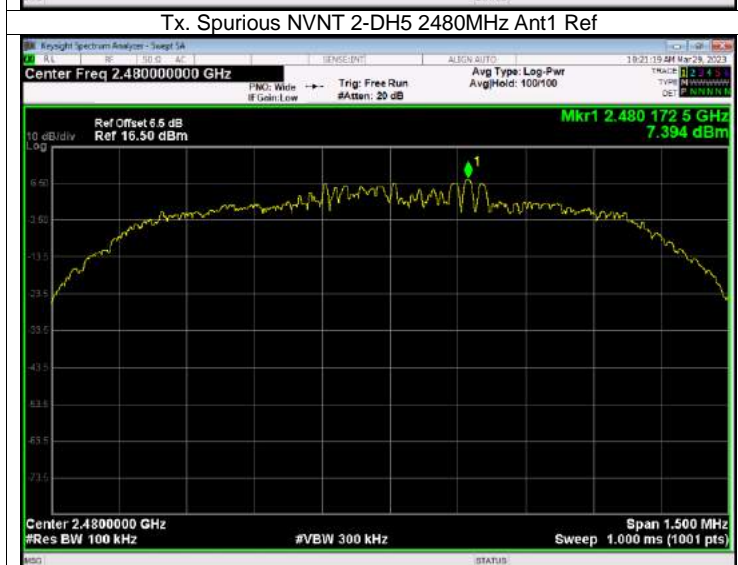
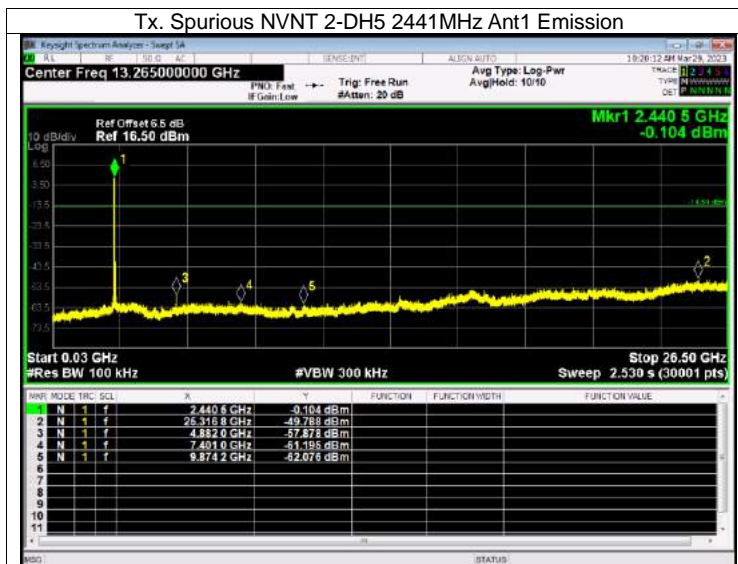

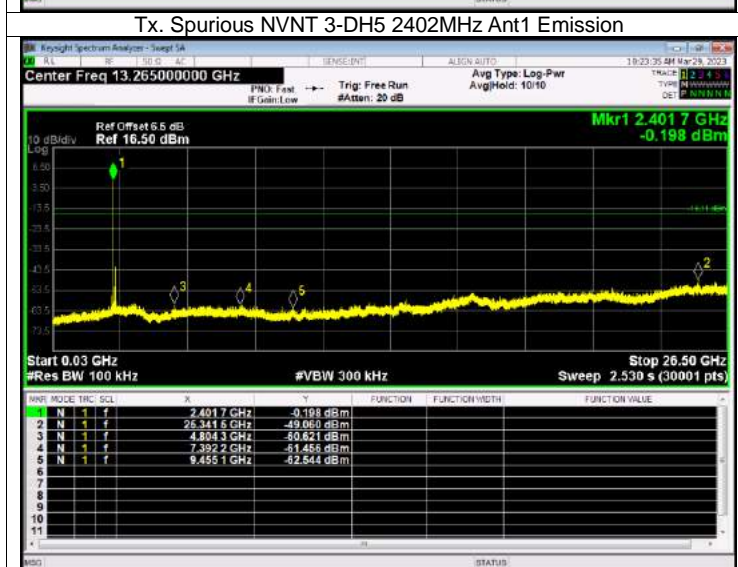

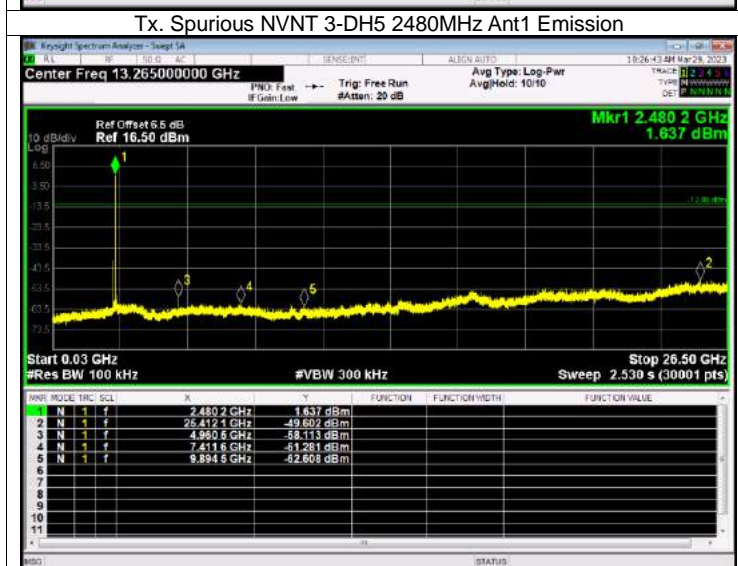
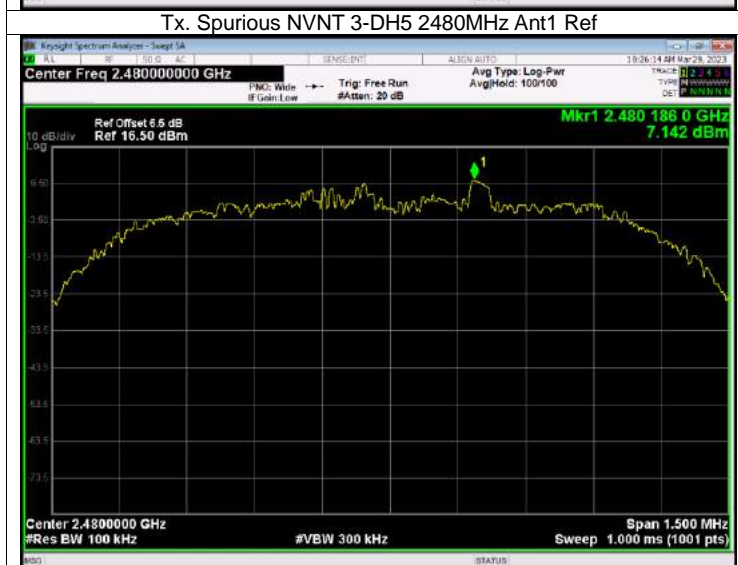
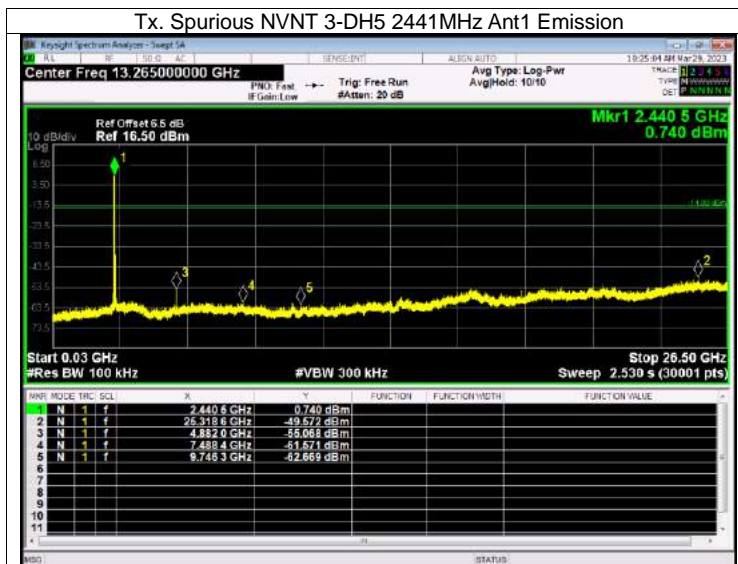



## Number of Hopping Channel

Condition	Mode	Antenna	Hopping Number	Limit	Verdict
NVNT	1-DH5	Ant1	79	15	Pass
NVNT	2-DH5	Ant1	79	15	Pass
NVNT	3-DH5	Ant1	79	15	Pass

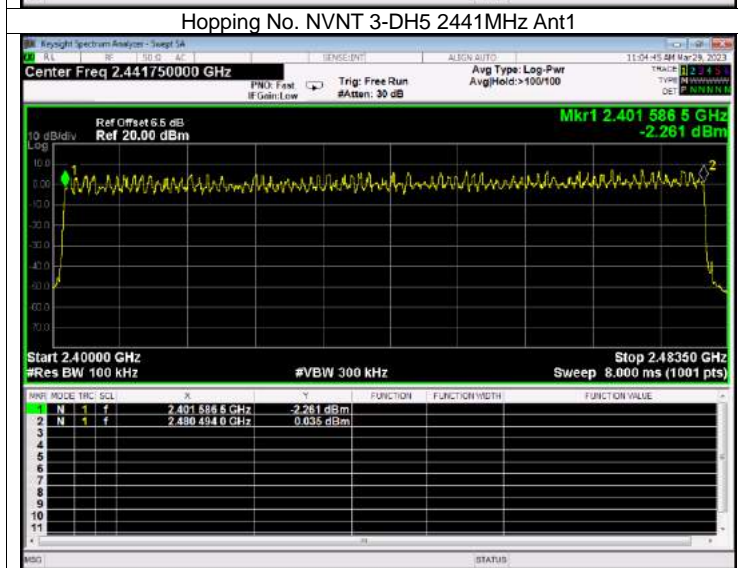
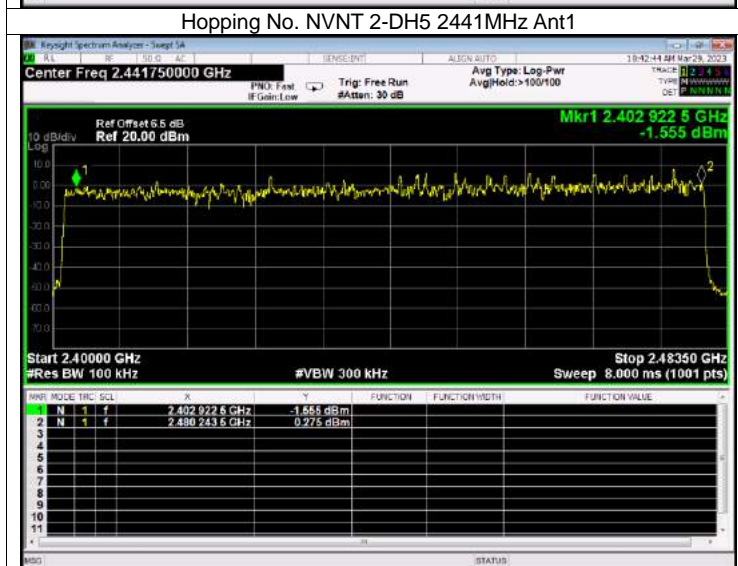
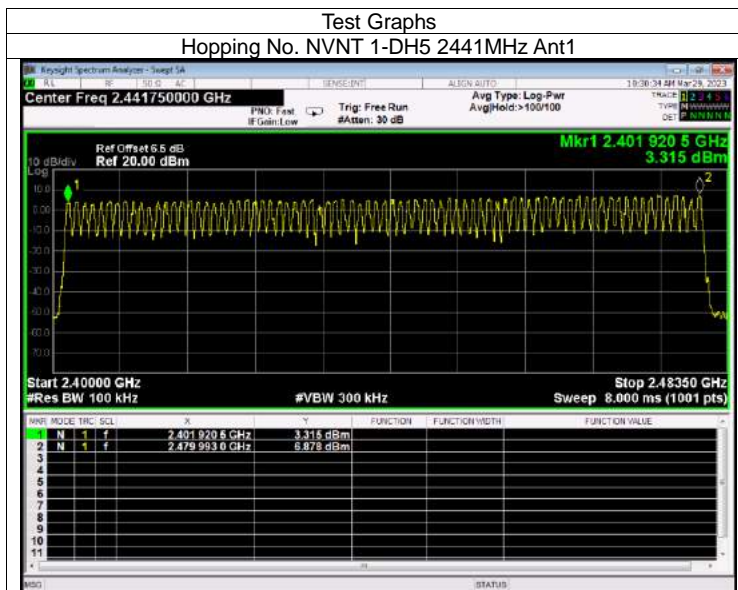



## Dwell Time

Condition	Mode	Frequency (MHz)	Antenna	Pulse Time (ms)	Total Dwell Time (ms)	Burst Count	Period Time (ms)	Limit (ms)	Verdict
NVNT	1-DH5	2441	Ant1	2.888	216.6	75	31600	400	Pass
NVNT	2-DH5	2441	Ant1	2.892	179.304	62	31600	400	Pass
NVNT	3-DH5	2441	Ant1	2.893	164.901	57	31600	400	Pass

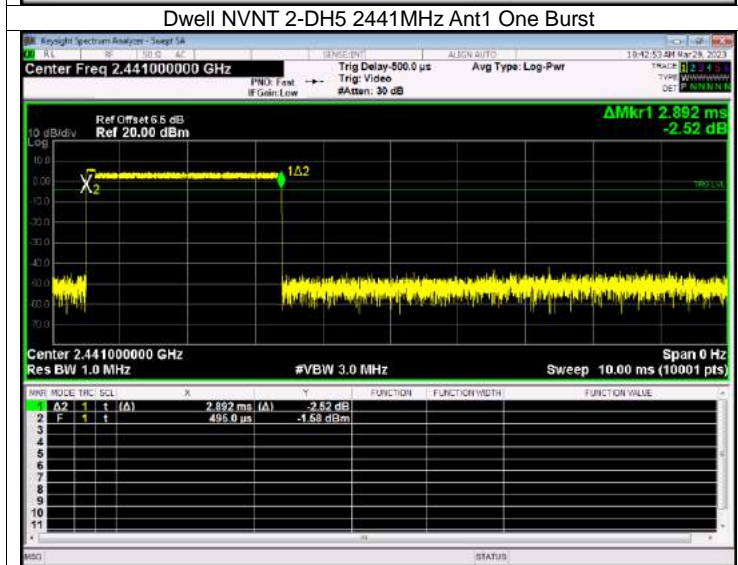
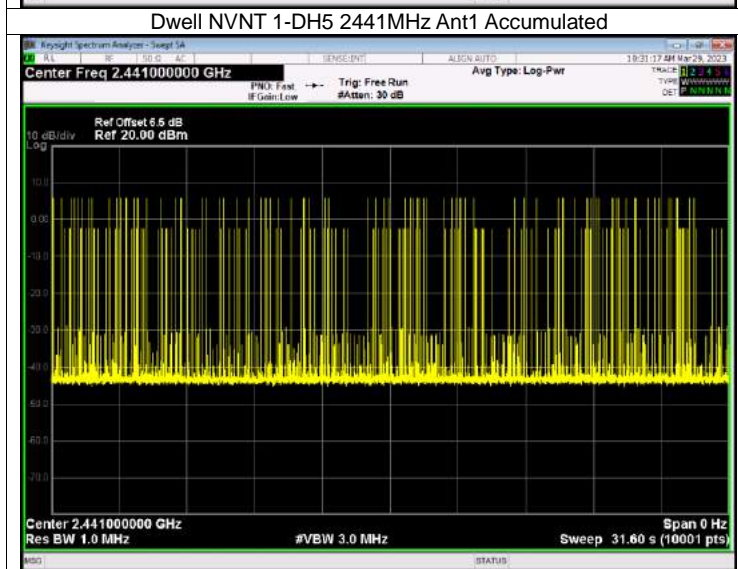
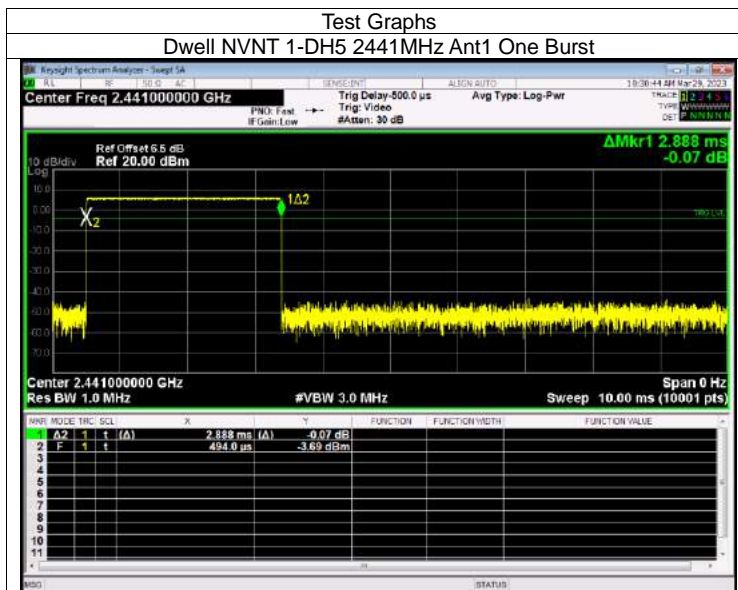



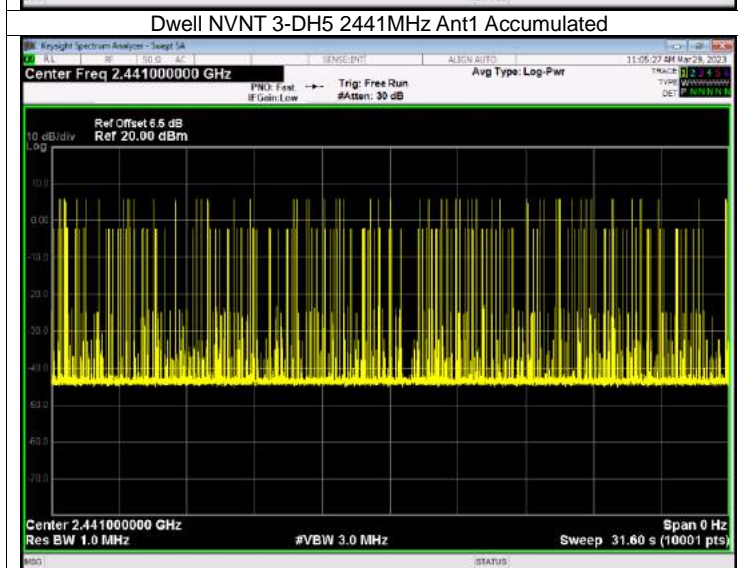
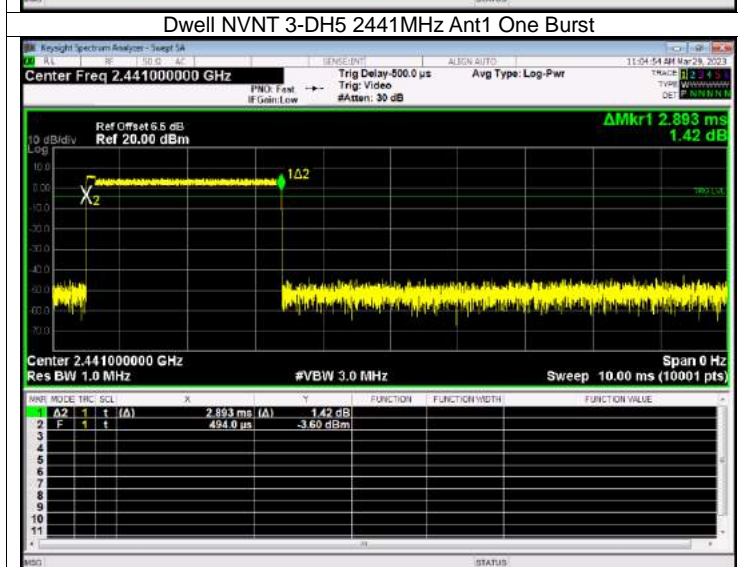
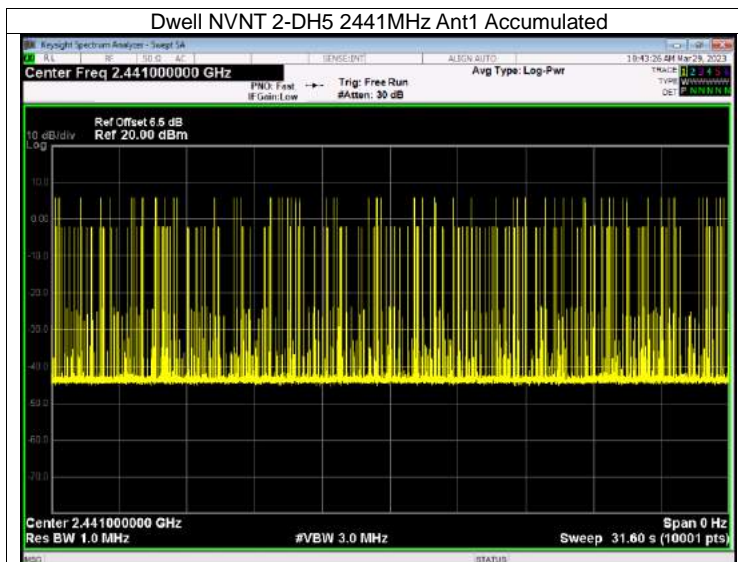



## APPENDIX II: PHOTOS OF TEST SETUP

**Radiated Spurious Emission Test Setup Photo - Below 1GHz**

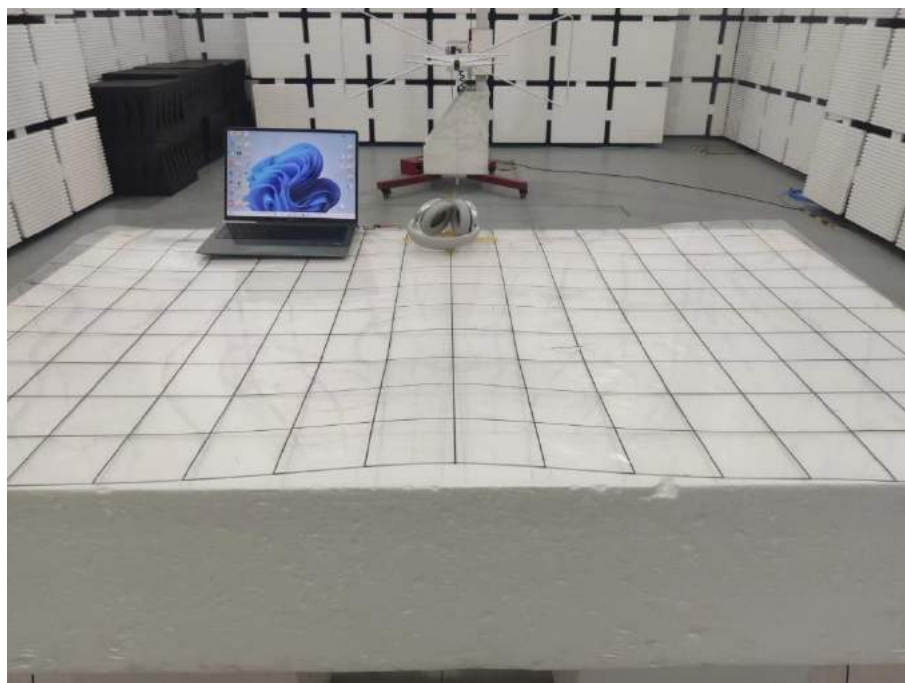

**Radiated Spurious Emission Test Setup Photo - Above 1GHz**



※※※※※END OF THE REPORT※※※※※