

SPECIFICATION

Power Supply Voltage
Max Current Consumption
Max Output Power

12V DC, Negative Ground 15A
4X60W

Vehicle player Manual



Private mold radiator

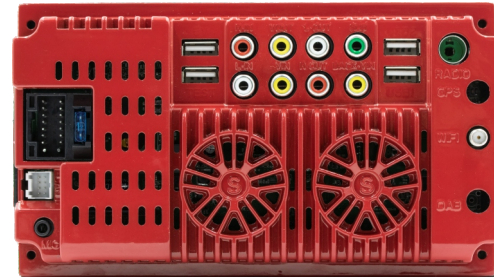

HD Display , Stereo Radio,
BT & CarPlay & Android Auto & Mirrorlink
Audio/Video/Picture Playback



Some models
not supported

Private mold radiator
CarPlay & Android Auto (wired & wireless)



BEFORE INSTALLATION

Thank you very much for purchasing and using our products, when you receive the product, please do not take the product directly to the car for installation, because the product is in the after a long journey, it may affect the product. Please try the machine before installing.

REAR INTERFACE DESCRIPTION

[Plug definition]

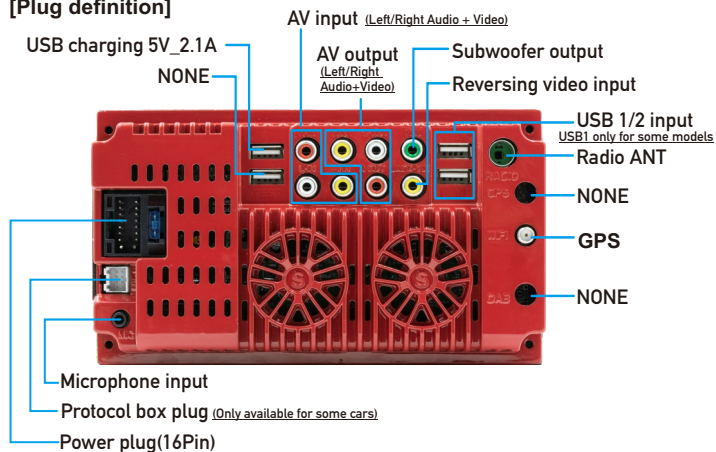

REAR INTERFACE DESCRIPTION

[Power Cable Definition]

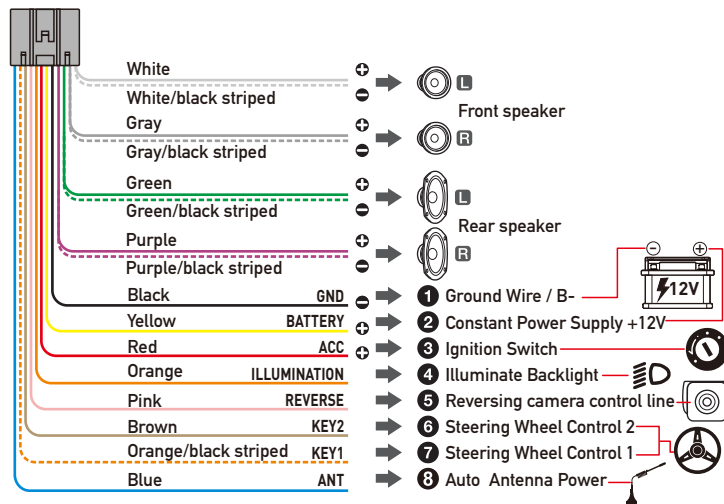

- * When the yellow line B+ and the red line ACC have a 12V positive power at the same time, the unit can be turned on normally.
- * The yellow line B+ keeps the power on and the machine has a memory function.
- * 8 speaker cables, each cable can not be grounded, can not be shared, can not touch the line, otherwise there will be no sound output, output sound distortion, machine fever and so on.

PRODUCT ACCESSORIES

USB line	GPS Antenna	Remote control	power cord	Screw Metal rack

REVERSING CAMERA INSTALLATION METHOD



Reverse Video Input

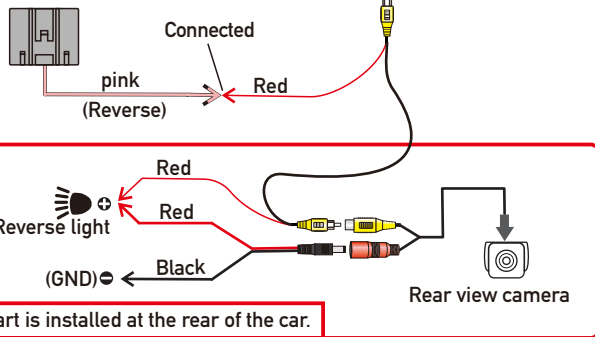

If the reversing camera is not installed, please do not connect the REVERSE/BACK cable to any place. Please leave the cable unconnected, otherwise the machine will not display properly, or it will automatically enter the reverse mode, which will cause the machine to fail. In case of such a situation, please disconnect the REVERSE/BACK line as soon as possible to avoid affecting the normal use of the user.

MACHINE FIXED REFERENCE METHOD

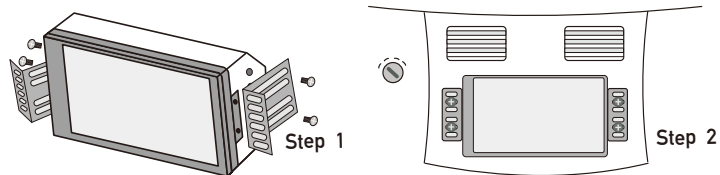

MAIN INTERFACE



1. Radio mode to listen to the radio station.
2. BT call interface.
3. All APPs.
4. USB multimedia playback.
5. System setting interface.
6. Date and time setting interface.
7. DSP sound effect setting interface.
8. Return to home page.
9. Wallpaper setting interface.
10. Calendar interface.
11. MirrorLink or CarPlay or Android Auto interface.
12. BT music interface.
13. USB2 multimedia playback.
14. AUDIO/VIDEO input.
15. Aux input (Only some models are supported.)
16. SD card multimedia playback. (Only some models are supported.)

RADIO FUNCTION



1. FM/AM Band switching, FM1-FM2-FM3-AM1-AM2.
2. Automatically search and store full-band radio stations.
3. Loop each station for 5 seconds.
4. LOC/DX: Long-range/short-range broadcast.
5. EQ sound effect setting interface.
6. RDS function (AF/TA/PTY).
7. Pre-stored stations. Can store 30 radio stations. When you need to listen to a certain fixed station, just click it.
8. </>: Short press to automatically search for the next station and play it; Long press to manually search for radio stations, step by 0.05MHz for each press, then long press P1, P2, P3, P4, P5, P6 to save the radio station.
9. Frequency slider, you can press and drag the slider to set the radio frequency.

MUSIC FUNCTION

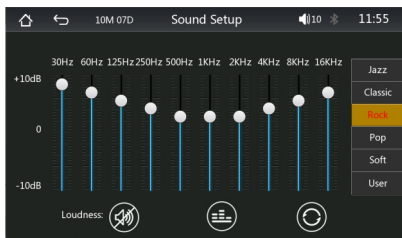

ENGLISH

5

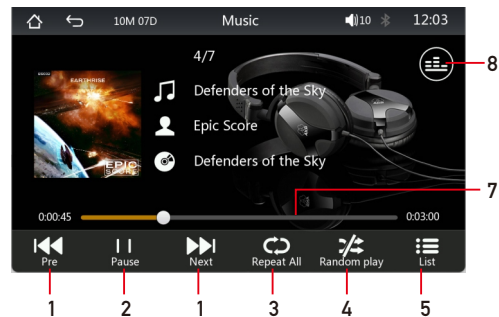

1. Previous track and next track.
2. Pause music / resume playback.
3. Single loop and all loop playback.
4. Sequential play and random play.
5. Return to file list.
7. The playback progress bar, you can slide to adjust the playback progress.
8. Enter the EQ sound effect setting interface.

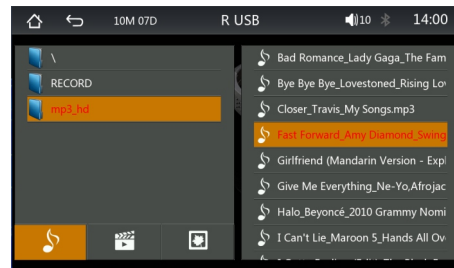

File management interface.
Music list/video list/picture list.

6

ENGLISH

PHOTO FUNCTION

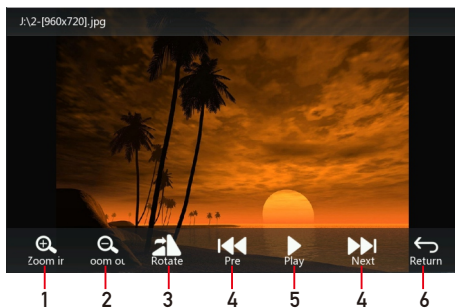

1. Zoom in picture.
2. Zoom out picture.
3. Rotate the picture.
4. Previous / next picture.
5. Pause / resume playback.
6. Return to file list.

VIDEO FUNCTION



1. Previous track and next track.
2. Pause video / resume playback.
3. Loop video playback.
4. Sequential play and random play.
5. Return to file list.
6. Slide to adjust the playback progress.

TIPS: When a brake warning occurs, turn off the brake warning switch in the system settings. You can play the video normally.

BT FUNCTION

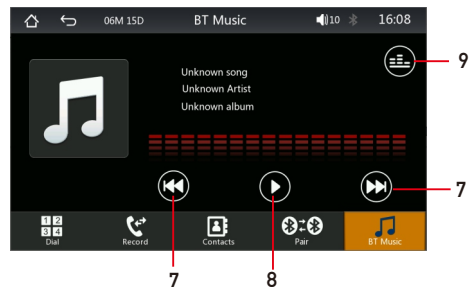
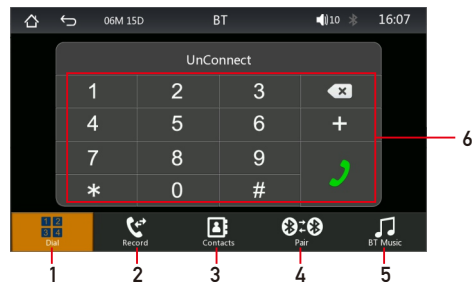

1. Make a call interface.
2. Call history interface.
3. Contact interface.
4. BT pairing interface.
5. BT Music interface.
6. Dial keypad interface.
7. BT Music Prev / next track.
8. Pause music / resume playback.
9. Sound effect settings.

Device Name: "CarPlay"
PIN Number: "0000" (If need)

Connection Method:

1. Power on the machine and turn it on.
2. Turn on the BT function on the mobile phone, click Search Device, when the mobile device list searches for the BT device name of the current machine, click the device name to connect it.

AV IN FUNCTION



You can connect an external Audio/Video, such as a mobile phone or iPod, through the front 3.5mm AUX or rear RCA hole.

STEERING WHEEL CONTROLS

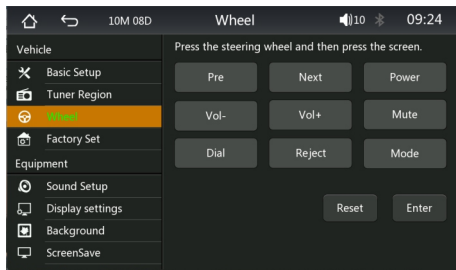

By learning, turn the buttons on the steering wheel into the function buttons of the player.

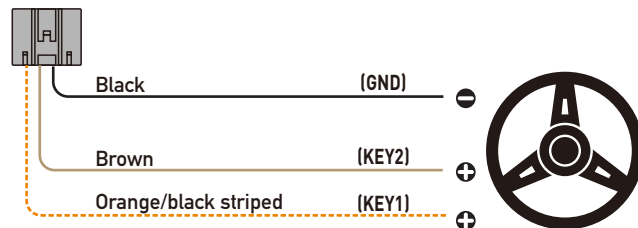

Wiring Method:

1. Locate the positive pole of the original car steering wheel button control line and connect it to the KEY line on the machine's output line.
2. Locate the negative pole of the original steering wheel button control line and connect it to the ground (power negative) line on the machine's output line.

Learning Method:

1. First press and hold the function key on the steering wheel, and then click the desired function key on the car screen. At this time, the key on the screen will be always on, indicating that the learning is successful. Then learn the second button in the same way. Finally, press the confirm button to complete the study.
2. When the operation error needs to be re-learned, just press the reset button and then re-learn.

PhoneLink (CarPlay & Android Auto & Mirrorlink)

When connected to the USB data cable, you can project the phone screen to the car screen.

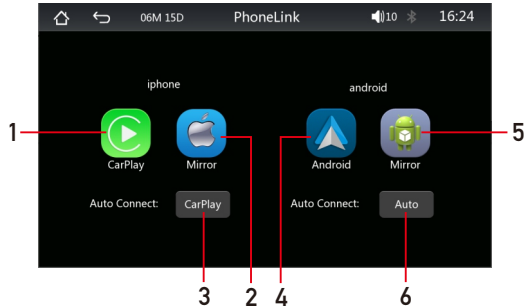

1. iPhone enter Apple CarPlay mode.
Support: ①wired CarPlay
②wireless CarPlay.
2. iPhone enter MirrorLink mode (Wired only).
3. The mode entered by default when an iPhone is connected.
"CarPlay / Mirrorlink / nothing" is selected.
4. Android phone enter Android Auto mode.
Support: ①wired Android Auto
②wireless Android Auto.
5. Android phone enter MirrorLink mode (Wired only).
6. The mode entered by default when an Android Phone is connected. "Android Auto / Mirrorlink / nothing" is selected.

Mirrorlink (iPhone)

When the device is plugged into the iPhone, the content on the phone's screen is projected onto the car's screen, and the sound is transmitted in sync.

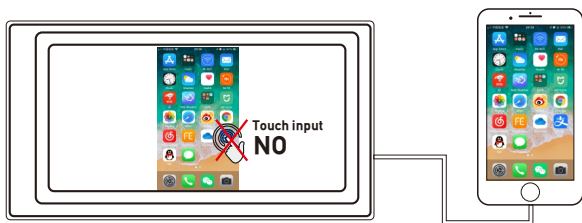

[You can't control your iPhone here.](#)

Mirrorlink (Android)

When using an Android device, after connecting the USB data cable, you will be prompted to install the Mirrorlink software. After installation, plug the data cable again, it will enter the screen mirroring mode. And it can be operated on both the player screen and the phone screen.

Only the image transfer is successful at this time. The sound can only be transmitted after the BT connection is successful.

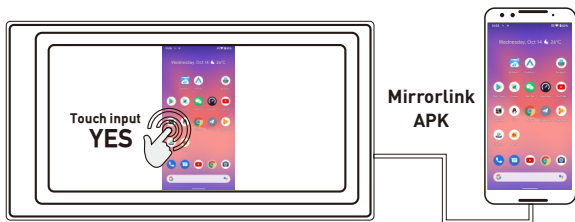

[You can also control your Android phone here.](#)

SYSTEM SETTINGS

Basic Setup:

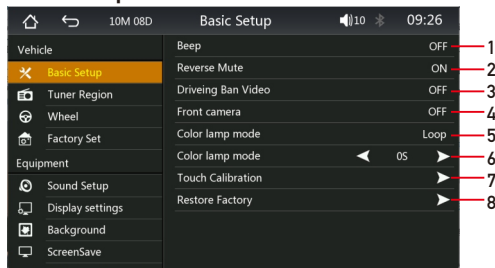

1. Beep: Key tone switch.
2. Reverse Mute: Mute switch when reversing.
3. Watch the video warning while driving.
4. Front camera ON/OFF.
5. Button light color: red-green-blue-cyan-purple-yellow-white-cycle.
6. Time to switch the color of the button light. Can be set from 1 to 30s.
7. Touch screen calibration.
8. Restore to factory settings.

Radio area:

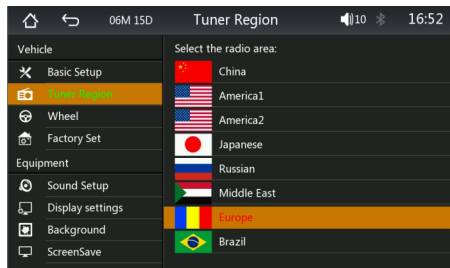

Set the appropriate radio frequency according to the region.

SYSTEM SETTINGS

Steering wheel learning:



By learning, turn the buttons on the steering wheel into the function buttons of the player.(See the detailed operating instructions for steering wheel control learning in the previous introduction.)

Factory Set:

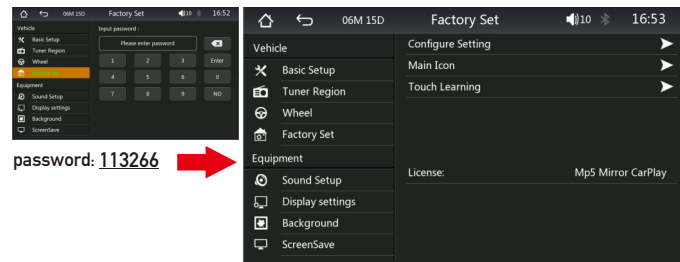

Enter the password "113266" to enter the factory setting interface.

SYSTEM SETTINGS

Sound Setup:

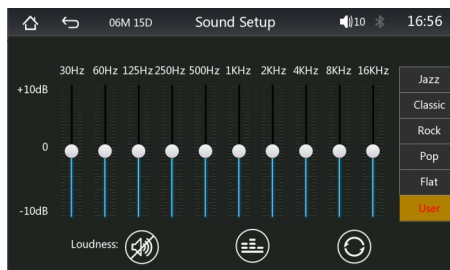

DSP sound effect setting interface.

Display Settings:

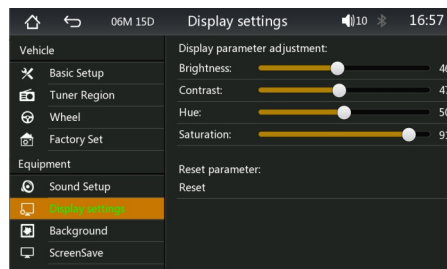

Brightness, contrast, hue, saturation can be set.

SYSTEM SETTINGS

Background image settings:

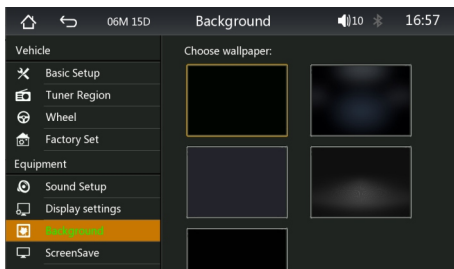

Toggle background image.

Screen saver settings:



Set screen saver switch and start time.

SYSTEM SETTINGS

Language settings:



Language settings for multiple countries.

Time setting:

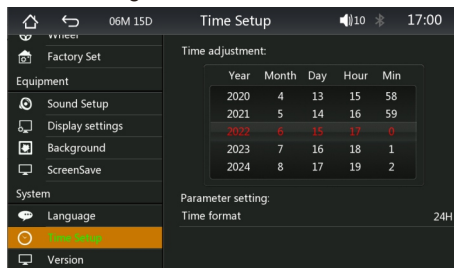

Set the year, month, day, hour and minute.

REMOTE CONTROL FUNCTION

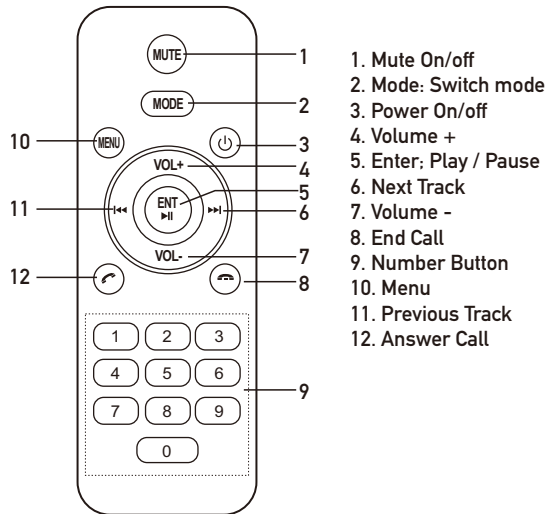

1. Mute On/off
2. Mode: Switch mode
3. Power On/off
4. Volume +
5. Enter: Play / Pause
6. Next Track
7. Volume -
8. End Call
9. Number Button
10. Menu
11. Previous Track
12. Answer Call

COMMON PROBLEMS AND SAMPLE TROUBLESHOOTING

1) Cannot boot normally

1. The car stereo has 3 lines: "Yellow""Red""Black", if only 2 line of them connected, it will not start. It should be that the yellow line is connected to the positive pole, red line to the key control line, black line to the negative pole. Less connection or wrong connection does not boot.
2. The original car line and unit wiring can not be connected according to the color, the color of the original car line is not standard. If you connect like that, it will not only do not turn on but also may burn.
3. The original car plug can't be plugged directly into the new unit, even if it just plugs in, it can't be used. Otherwise it won't be turned on or it may burn.
4. The 3 wires are connected right, but it does not boot. Please check if the fuse on the yellow line is broken. If there is no problem with the fuse, try to twist the yellow and red wires together. Turn on the key and press the unit's

power button to see if it can be turned on.

5. Every time you change the fuse, it burns. Please don't change it again. The reason is that when you first connect the positive and negative poles, the protection circuit of the unit is short-circuited. The unit can be repaired under the guidance of our master. No basis can only be returned to the after-sales or give you a new unit. If these are no problem, or also don't boot, please make the final step to confirm, find a 12V battery or 12V power supply, "yellow" and "red" lines twist together with the positive pole, black line to the negative, press the button to check if it can boot or no. If you can boot, it showed that the original car line is not right connect, or there is a problem with the car line. If it can't be boot, then the unit is broken. Does not boot unit, please check the line carefully firstly, do not blindly suspect this is the unit problem.

2) Automatic shut-down

1. The cable error connect: If the blue cable (automatic antenna power supply) is connected to the power cable of the unit, an automatic shutdown will occur. Please follow the correct wiring method to solve the problem.
2. The voltage is unstable: please find a 12V-5A which one is the power supply and re-tested to see if it will automatically shut down. If it does not automatically shut down after the test, please replace the power supply. If it will automatically shut down, it is problem with the unit.

3) There is noise

1. The original speaker power is too small. When the volume of the unit is tuned up, there will be noise.
Solution: When replacing the speaker or listening to the song, the volume should not be too large.
2. The speaker cable is grounded.
Solution: Take the iron speaker cable directly connected to the speaker cable of the unit.

4) Remote control cannot be used

1. Test method: Turn on the camera of the mobile phone and align the light of the remote control, then press the button of the remote control to see if the phone will light up. If it is not lit, there will be no power, you need to replace the battery; if it is lit, there is electricity, which proves that there is no problem with the remote control.

5) Settings can not be saved (no memory)

1. The yellow line and the red line are connected together (separate yellow to positive, red to key control).
2. Yellow and red are reversed (just change position).

6) Bluetooth does not work

1. Turn on the unit, use the phone Bluetooth search, search for "Device default name", then click the connection, after connecting, you can answer the phone or Bluetooth to play the song.

7) The product emits smoke

1. Replace the fuse FUSE, if the problem cannot be solved, the internal circuit has been burned. After-sales service is required.

8) The sound cannot be adjusted

1. Please reset the unit or unplug the power cord and plug it in.
2. The Volume knob is broken, and the knob can be replaced.

9) Reversing camera does not display

1. Wrong wiring or missing wiring.

Camera connection method:

1) Find accessories : 1 camera + 1 power cord +1 video cable.

2) Find the port of the wiring.

First find the reverse control line on the power line of the unit. The control line is a pink line, connect this line to the positive pole of 12V and the screen will turn blue. And then find the CAM video input interface on the back of the unit, find the positive and negative of the backup light.

3) There are two sockets on the camera, the red socket is connected to the power cable, the yellow is inserted into the video cable, the red wire of the power cable and the wire of the video cable are screwed together on the positive pole of the reverse lamp, and the black wire of the power cable is not used, connected, the other end of the video cable is connected to the CAM video input interface on the back of the unit. The red line coming out of the video line is connected to the reversing control line of the power line.

2. The camera is broken. If the lamp that is properly wired to the camera is not lit, it will be broken and replaced with a new one.

10) USB devices cannot be played

1. Format the USB flash disk, and the file system is selected as: FAT32, re-download on or two songs and try again. If it still doesn't work, please replace the USB flash drive.

11) Radio does not receive the radio station

1. The antenna plug is not fully inserted, the antenna is disconnect or the line is disconnect.
2. Search station, press AS will automatically search or press before or after button.
3. Can't solve the above 2 points, Please unplug the antenna plug and find a screwdriver or a metal strip to insert it instead of the antenna.

12) There is no sound right after installation

1. Dear customers, the unit has been tested before shipment. If there is no sound, it is usually a wiring error or the original car speaker wire is short-circuited with iron. According to the steps to check it:
2. Check if the speaker cable is short-circuited and connected. Please reconnect if you have any short circuit.
3. Check how many speaker cables according to the original speaker cable if there are only 2 speaker cables to prove that the original car line does not match our unit, you need to re-route the original car line. One speaker must lead to 2 speaker wires. 2 speakers must be have 4 speaker cables to available.

13) There is no sound after a while

1. Disconnect all the speaker cable from the unit (do not remove them), and then find an external speaker to receive the gray and purple of the tail line of the unit. Green any group, and then try to see if there is any sound. If there is a sound, it is proved that the car's speaker line is short-circuited with iron or the speaker is damaged. If there is no sound, the unit is broken.

This device complies with part 15 of the FCC Rules. Operation is subject to the following two conditions: (1) This device may not cause harmful interference, and (2) this device must accept any interference received, including interference that may cause undesired operation.

Any Changes or modifications not expressly approved by the party responsible for compliance could void the user's authority to operate the equipment.

Note: This equipment has been tested and found to comply with the limits for a Class B digital device, pursuant to part 15 of the FCC Rules. These limits are designed to provide reasonable protection against harmful interference in a residential installation. This equipment generates uses and can radiate radio frequency energy and, if not installed and used in accordance with the instructions, may cause harmful interference to radio communications. However, there is no guarantee that interference will not occur in a particular installation. If this equipment does cause harmful interference to radio or television reception, which can be determined by turning the equipment off and on, the user is encouraged to try to correct the interference by one or more of the following measures:

- Reorient or relocate the receiving antenna.
- Increase the separation between the equipment and receiver.
- Connect the equipment into an outlet on a circuit different from that to which the receiver is connected.
- Consult the dealer or an experienced radio/TV technician for help.

This equipment complies with FCC radiation exposure limits set forth for an uncontrolled environment. This equipment should be installed and operated with minimum distance 5mm between the radiator & your body.