

## D1 - 3 C hannel 4K Dash Camera

4K+1080P/4K+2K/4K+1080P+1080P



### Instruction Manual

Please read this manual carefully before using this product

# Notice

Thanks for ordering D1 3 Channel 4K Dash Camera. Please read this manual before using the camera. If the damage is caused by failure to follow the instruction, the warranty will be voided.







1. Please use the original power cable coming with the package. Do not connect this dash cam with the non charger, the unmatched charger or voltage converter may damage battery of dash cam, even causes dangerous.
2. Do not try to open the cover or disassemble the internal battery by yourself without professional instruction.
3. Do not put the product into the fire.
4. Do not use the product if it has become wet, or do not touch the charger with wet hands.
5. Please insert a micro SD card over class 10 that is compatible with the SDXC standard. The storage is minimum support 512MB, max to 256GB.
6. For the first time use, please insert the SD card before powering the dash cam, and format the SD card on camera or PC.

# Content

01 Package Lists.....	01
02 Product Diagram.....	02
03 Installation.....	04
04 Product Specification.....	05
1.Power On/Off.....	05
2.Video Recording Mode.....	05
3.Photo Mode.....	05
4. Video Playback Mode.....	05
5.Menu Setting.....	06
6. Parking Mode Instruction.....	12
7.WIFI and App Instruction.....	12
8.GPS Instruction.....	13
9.Transport files to PC.....	14
05 Tech Specs.....	15
06 Warranty.....	15

# 01 Package Lists

## D1 Front Camera

 Front	Standard Accessories		
	 Suction cup×1	 Cigarette lighter×1	 User manual×1
 Rear Camera×1	With Rear Camera		
	 Rear camera cable×1	 3M sticker×1	

## D1 Front Camera + Inside Camera

 Front + Inside	Standard Accessories		
	 Suction cup×1	 Cigarette lighter×1	 User manual×1
 Rear Camera×1	With Rear Camera		
	 Rear camera cable×1	 3M sticker×1	

D1 Dash Camera Step-down line for Parking Mode  
(Output current: 3A)



# 02 Product Diagram

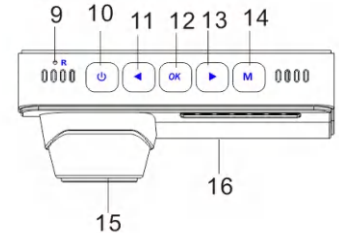
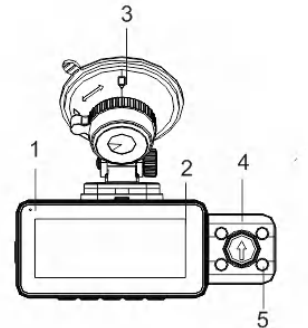

- |                              |  |
|------------------------------|--|
| 1. LED indicator             | 9. Reset Button                                    |
| 2. Display                   | 10. Power Button                                   |
| 3. Magnetic suction cup      | 11. Up Button 【Up/Lock/Switch/WiFi】                |
| 4. Inside camera             | 12. OK Button 【Confirm/Video】                      |
| 5. IR light                  | 13. Down Button 【Scroll down/Switch Cameras/Audio】 |
| 6. Type-C port               | 14. M Button 【Menu/Mode Switch/Picture】            |
| 7. TF card slot              | 15. Front Camera                                   |
| 8. Rear camera/Earphone port | 16. Mic  |

# 03 Installation

## • Install Front Camera







1. Connect the device with suction cup, then install it on windshield and make sure the dash cam will not distract drivers' view.
2. Connect the device with cigarette lighter for power supply, and hide the rest cable into the edge of car.
3. Start the engine of car, the device will be powered on automatically.

## • Install Rear Camera

1. Connect the device and rear camera with the cable.
2. Stick the rear view camera to the rear window with 3M glue, and hide the rest cable into the edge of car.



### Note:

1. The rear view camera is not waterproof, please do not install it outside the car.
2. The length of rear camera cable is about 6 meters. The red wire on extended cable can be connected to the reversing lamp positive, then dash cam will be switched to the rear camera when reversing the car.



Resolution	Icon	Function Explanation
Power Button 【turn on/off screen】		<ol style="list-style-type: none"> <li>1. Press 2 seconds to power on/off</li> <li>2. When the device is on, short-press to turn on/off the screen</li> </ol>
Up Button 【scroll up/lock/WiFi】		<ol style="list-style-type: none"> <li>1. On Menu/playback page, short-press to scroll up</li> <li>2. On video recording mode, short-press the button to lock/unlock video</li> <li>3. On video recording mode/playback page, long-press to turn on/off WiFi</li> <li>4. On playback page, short-press to fast backward the video</li> </ol>
Ok Button 【confirm/video】		<ol style="list-style-type: none"> <li>1. Menu/Video playback: short-press to confirm the selection</li> <li>2. Video mode: short-press to start/stop recording</li> </ol>
Down Button 【scroll down/switch camera/audio】		<ol style="list-style-type: none"> <li>1. Menu/video playback: short-press to scroll down</li> <li>2. On video recording mode/video playback: short-press to switch the cameras/front/inside/rear/front+inside/front+rear/front+inside+rear</li> <li>3. On video recording mode: long-press to turn on/off audio</li> <li>4. On video playback: short-press to fast forward the video</li> </ol>
M Button 【menu/mode switch/photo mode】		<ol style="list-style-type: none"> <li>1. When stop recording, short-press to enter/exit the menu setting</li> <li>2. When stop recording, long-press to switch the video recording mode/playback page</li> <li>3. Video recording mode: short-press to take photo</li> <li>4. Video play back mode: short press to set up the video or back to previous step</li> </ol>

# 04 Product Specification

## 1. Power On/Off

- Power on: The device will automatically enter video recording mode when press the Power Button  or connect the device to car charger.
- Power off: Long press and hold the power button  until the screen being off.

## 2. Video Recording Mode



- Insert the micro SD card into the card slot, and power on the device, the dash cam will be on recording mode, and the icon will turn .
- Press the **OK** button to stop recording, the  on the display will stop blinking and disappear.
- Press **OK** button again, and the recording mode will be restarted.







## 3. Photo Mode

- On recording mode, press **M** button to take photos.

## 4. Video Playback Mode

- Press **OK** to stop recording, long press **M** button to enter video playback page. The left list will show the videos and pictures chronologically. Icon  on upper left represents video file, and  is picture file. The letter at the end of files name represents the cameras, A represents the recording videos of front camera, B represents inside camera, and C is the file of rear camera.



- Press / to select the file and press **OK** button to play the video or picture.
- Short press **M** button to set the videos. Click  to delete current video/all videos, click  to lock current/all, and click  to unlock current/all. The locked video won't be overwritten, unless it is unlocked.

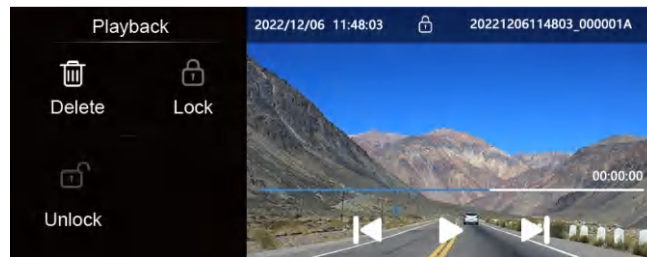

## 5. Menu Setting

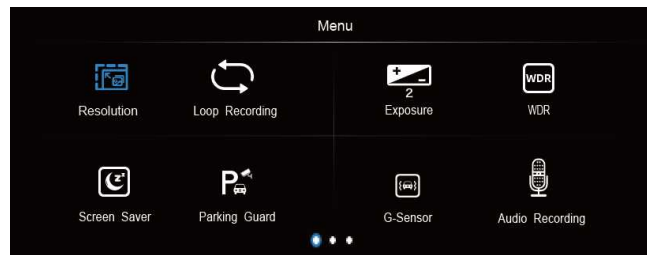

## • Resolution

The cameras can be selected by switching the resolution. Please note that only the selected camera will record the videos, the non-selected camera won't record.

Resolution	Icon	FPS	Camera	Recording time with 128G SD Card Default Duration: 3mins
<b>Front + Inside + Rear</b>				
3840 x 2160P	UHD P30	30FPS	Front	10h
2560 x 1440P	QHD P30	30FPS	Front	21h
1920 x1080P	FHD P30	30FPS	Front	30h
2160P+1440P	UHD+QHD	24FPS	Front+Inside	13h
2160P+1080P	UHDP30+FHD P30	30FPS	Front+Inside	8h
1440P+1080P	QHDP30+FHD P30	30FPS	Front+Inside	15h
1080P+1080P	FHD P30+FHD P30	30FPS	Front+Inside	18h
2160P+1080P+1080P	UHD+FHD+FHD	24FPS	Front+Inside+Rear	14h
1440P+1080P+1080P	QHD+FHD+FHD	30FPS	Front+Inside+Rear	9h
1080P+1080P+1080P	FHD+FHD+FHD	30FPS	Front+Inside+Rear	10h
<b>Front + Rear</b>				
3840 x2160P	UHD P30	30FPS	Front	10h
2560 x1440P	QHD P30	30FPS	Front	21h
1920 x1080P	FHD P30	30FPS	Front	30h
2160P+1440P	UHD+QHD	24FPS	Front+Rear	13h



## • Loop Recording

To set the recording duration of each video, if the memory card is full, the new video will overwrite the earliest videos automatically.

Options: Off/ 1min/3mins/5mins/10mins

System Default: 3 min

## • Exposure

Set the exposure level as desired, causes the video become dark or bright.

Options: -2.0 -5/3 -4/3 -1 -2/3 -1/3 +0.0 +1/3 +2/3 +1 +4/3 +5/3 +2.0

System Default: +0.0

## • WDR

WDR can make the dash cam shoot the details clearly in the darker or brighter situation, and expand the shooting range.

Options: On/Off

System Default: On

## • Screen Saver

This function enables the screen to auto-off, but the dash cam is still on recording.

Options: Off/1min/2mins/5mins/10mins

System Default: Off

## • Parking Guard

When select parking guard, please connect the step down-line first. In parking mode, the dash cam continuously buffers video and saves a parking recording when motion is detected within the dash cam's field of view.

Options: Off/Time lapse video/Parking Guard

System Default: Off

## • G Sensor

When the G-sensor detects significant or sudden movement , (such as an impact or collision) it will trigger an event recording. You can adjust the sensitivity, so minor incidents and bumps won't trigger an event recording.

Options: Low/ Medium/ High

System Default: Low

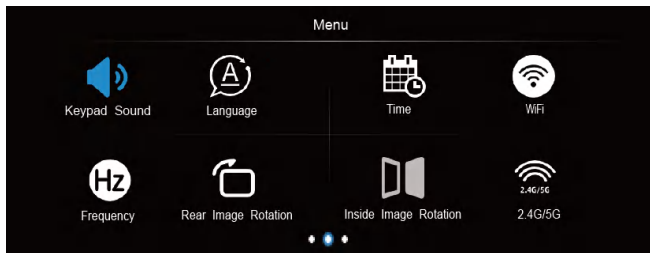

- Audio Recording

Options: On/Off  
System Default: On

- Keypad Sound

Options: On/Off  
System Default: On

- Language

Options: English/Japanese/Russian/Simplified Chinese/Traditional Chinese/Italian/German/Portuguese/Spanish/French  
System Default: English

- Time

To set up the Date/Month/Year, and select 12-hour clock and 24-hour clock.

- WiFi

The WiFi function is designed for connecting the dash cam wireless with your smartphone to access the recordings and function settings of your dash cam.

Options: On/Off  
System Default: Off

- Frequency

To set or reset the frequency of the AC power to reduce interference of fluorescent lights (In the USA and Canada, set it to 60Hz).

Options: 50Hz/60Hz  
System Default: 60Hz

- Rear Image Rotation

Mirror Flip the image of rear view camera.

Options: On/Off  
System Default: On

- Inside image Rotation

Mirror Flip the image of inside camera.

Options: On/Off  
System Default: On

- 2.4G/5G

Switch Wifi transmission speed to 2.4G or 5G.

Options: 2.4G/5G  
System Default: 5G

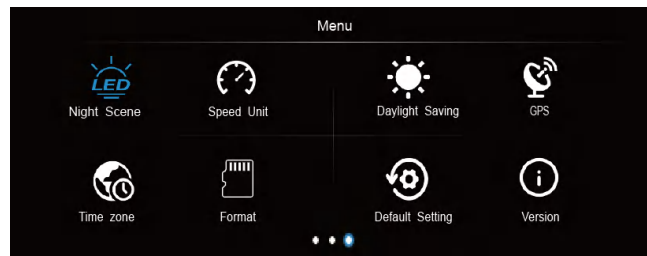

- Night Scene

Infrared LED lights of inside camera

Auto/On/Off  
System Default: Auto

## • Speed Unit

Options: KM/H、MP/H  
System Default: KM/H

## • Daylight Saving

Options: On/Off  
System Default: Off

## • GPS

The GPS of this machine is a live tracking record and storage, including the recording of speed, time, mileage, and other state information when the car is moving, then output the information via the interface.

Options: On/Off  
System Default: On

## • Time Zone

24 Time zones all over the world, you can select the time zones according to your country's location.  
System Default: GMT+08:00

## • Format

When formatting the card, all files will be erased. Upload all files you would like to save to your PC BEFORE you start to format the card.

Options: Yes/NO

## • Default Setting

Reset all settings to factory preset. Please set it carefully, the original personalized setting parameters will not exist after setting.

Options: Yes/NO

## • Version

Click to check the device version.

## 6.Parking Mode Instruction

- The parking mode function is required to connect the step-down line. The step-down line is not included in the package, please purchase it separately if you need it.

- Parking mode defaults OFF.
- Parking mode ON.

1. If selecting parking guard option, the icon in the status bar will show **P**, then disconnect the ACC to power off the dash cam. Once collision occurs, the device will be turned on to record videos, then it will be turned off automatically after the motion or collision ends.
2. If selecting time-lapse option, the icon in the video recording status bar is . After disconnecting ACC, the device keeps recording. Video resolution will automatically jump to 1080P, recording time-lapse of 2FPS per second.

## 7.WiFi and App Instruction

- Download App and connect WiFi



1. Download APP **Witcam Pro** from App store or Google Play.

WITCAM PRO APP downloaded via below address or scanning QR code:

<https://play.google.com/store/apps/details?id=com.zj.witcampro>





(Witcam Pro App)

2. Long Press  or short press  to enter system and open WiFi, it will show SSID name and password in the led display, **SSID name: ZD81\_CARDV684e05ca6d3c**
3. Open WIFI on mobile phone, and find SSID name (default password is **12345678**), input password, then connect WiFi of the dash cam.
4. Open **Witcam Pro** in the mobile phone, click and add the device, it will connect to dash camera. The device can be set via the app like taking photos, recording or sharing videos.



## • App Instruction

1. Click  to start/ stop recording, when recording stop, click  to enter the memory card of dash cam and checking or downloading videos, photos or Emergency recording; Click  to set up the functions of dash cam.
2. After disconnect the WiFi of dash cam, then enter the album of **Witcam Pro** to playback, share or edit the download videos.



## Note:

- When connect the WiFi of **Witcam Pro** , the internet of phone will be cut off. Please disconnect the **Witcam Pro** WiFi if you need to use internet function of the phone.
- The WiFi signal range is about 10 meters. It will disconnect from your smartphone if it is over the range.

## 8.GPS Instruction

The built-in GPS can record the driving trace and show the tracking on mobile phone or PC.

- On mobile phone: Download recording videos from **Witcam Pro** , disconnect the App WiFi, then connect the internet, enter **Witcam Pro** to play the video, it will show the GPS trace.
- On PC: Transport the videos to PC and play on GPS player.

Download Witcam Pro PC:

<http://www.ligoor.com/app/witcam/witcampc.html>



(Witcam Pro PC)



## 9.Transport files to PC

- Connect the dashcam and PC via USB.
- The dash cam will turn on automatically, and the screen will display "Mass Storage" and "PC Camera".
- Select "Mass Storage" option, the dash cam can be read as a storage disk on the computer.
- Follow the instructions on the computer, watch or save the videos/photos you need.

# 05 Tech Specs

Function	Parameter
CPU	Nt98529
Sensor	Sony IMX335(Front) , Sony IMX307(Inside) , Sony IMX307(Rear)
Display	3.2inch IPS, MIPI 820*RGB*320
Video Format	MP4
Video Code	H.265
Video Mode	Loop Recording
Photo Format	JPEG
Recording Time	Off/1min/3mins/5mins/10mins
Parking Mode	24 hours
G-sensor	Off/Low/Medium/ High
G-sensor Lock	Support
WDR	Support
ADAS	Not Support
Night Vision	IR LED
GPS	Support
WiFi	Support
Languages	English/French/Spanish/Portuguese/German/Italian Simplified Chinese/Traditional Chinese/Russian/Japanese.
Storage	256G( More than Class 10 )
USB Interface	Type-C
Operation System	Windows XP/Win7/Win10/Mac OS
Power	DC 5V 2A
Storage temperature	(-30℃--70℃)
Working temperature	(-20℃--60℃)
View Angle	165°(Front)+165°(Inside)+170°(Rear)

Warning: Changes or modifications not expressly approved by the party responsible for compliance could void the user's authority to operate the equipment.

NOTE: This equipment has been tested and found to comply with the limits for a Class B digital device, pursuant to Part 15 of the FCC Rules. These limits are designed to provide reasonable protection against harmful interference in a residential installation. This equipment generates uses and can radiate radio frequency energy and, if not installed and used in accordance with the instructions, may cause harmful interference to radio communications. However, there is no guarantee that interference will not occur in a particular installation. If this equipment does cause harmful interference to radio or television reception, which can be determined by turning the equipment off and on, the user is encouraged to try to correct the interference by one or more of the following measures:

- Reorient or relocate the receiving antenna.

- Increase the separation between the equipment and receiver.

- Connect the equipment into an outlet on a circuit different from that to which the receiver is connected.

- Consult the dealer or an experienced radio/TV technician for help.

## FCC Radiation Exposure Statement:

This equipment complies with FCC radiation exposure limits set forth for an uncontrolled environment. This equipment should be installed and operated with minimum distance 20cm between the radiator & your body.

# 06 FCC STATEMENT :

This device complies with Part 15 of the FCC Rules. Operation is subject to the following two conditions:

- (1) This device may not cause harmful interference, and
- (2) This device must accept any interference received, including interference that may cause undesired operation.