

Shenzhen Shimu Technology Co., Ltd.

Frequency: 2400MHZ-2500MHZ

Topocom —The test report
www.topolink.com.cn

2022-08-29

1. Test Environment: CTIA 743, 8960/5515C

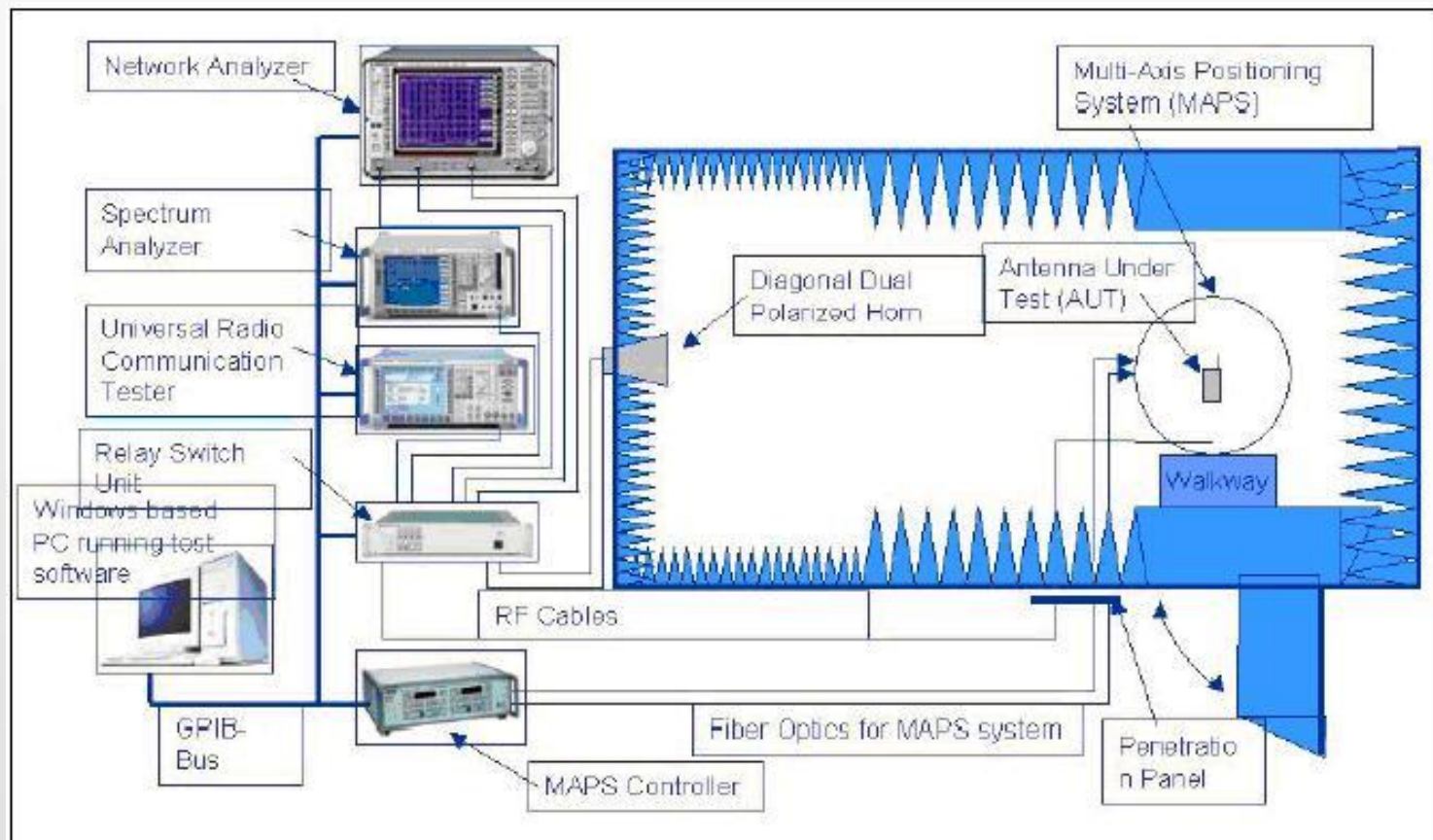

2. Matching Circuit

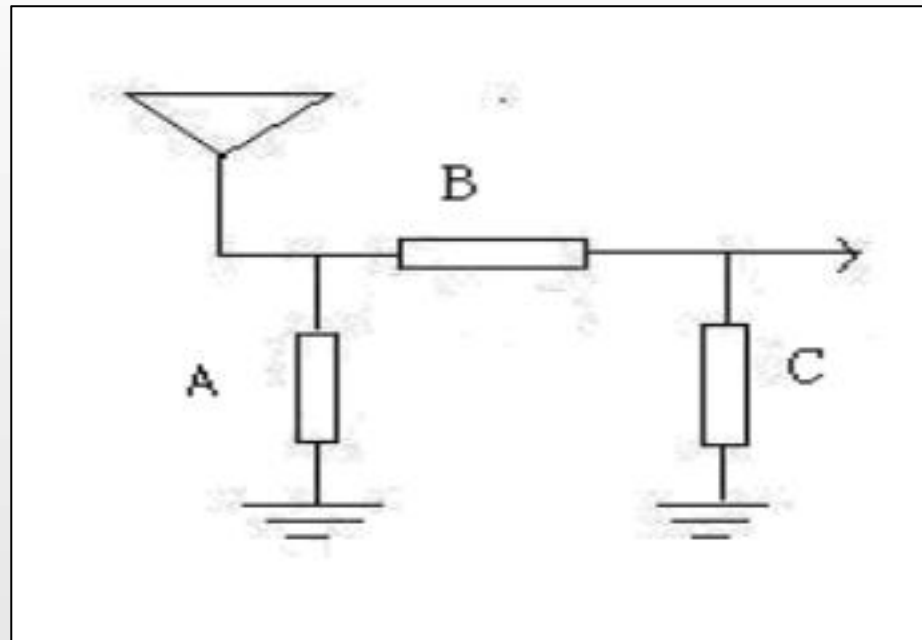

3.EUT And Antenna Photo



4. Test Result

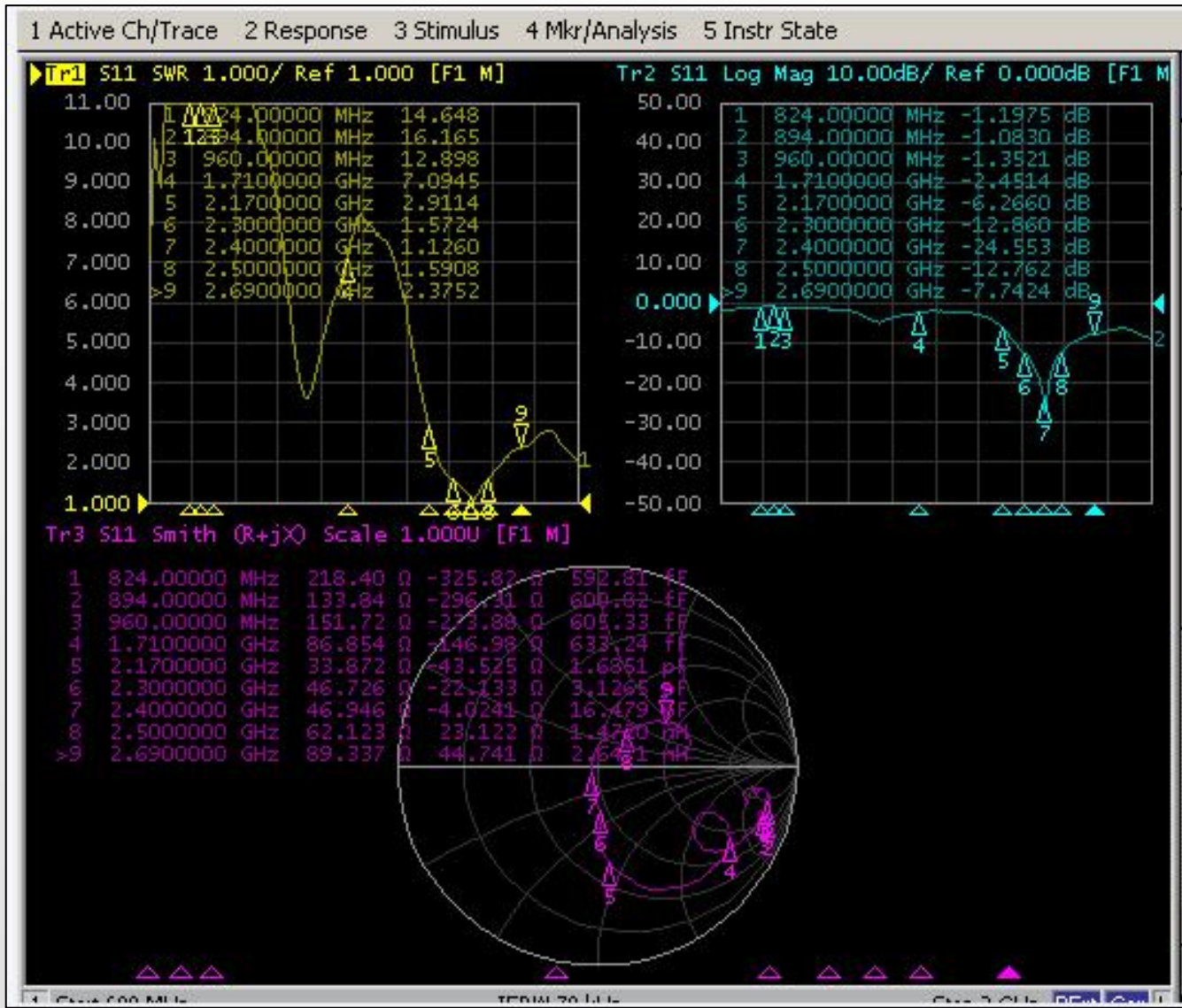

5. Efficiency And Gain:

Freq (MHz)	Effi (%)	Gain (dBi)
2400	52.08	2.4
2405	52.49	2.58
2410	53.12	2.55
2415	53.81	2.46
2420	55.5	2.46
2425	56.75	2.62
2430	57.05	2.77
2435	58.04	3.01
2440	59.49	3.19
2445	60.97	3.41
2450	62.5	3.48
2455	63.79	3.7
2460	64.16	3.84
2465	64.05	3.72
2470	64.35	3.73
2475	65.28	3.7
2480	65.96	3.74
2485	68.18	3.69
2490	69.94	3.71
2495	68.92	3.71
2500	68.98	3.59

6. 2D/3D Test Photo:

