



TEST REPORT

FCC ID: 2A4MT-PB24

Applicant: Shenzhen Zhenghaixin Technology Co., Ltd.
Address: Area 301A, No.7 Xiongyu Road, Tangxiachong Community, Yanluo Street, Baoan District, Shenzhen
Manufacturer: Shenzhen Zhenghaixin Technology Co., Ltd.
Address: Area 301A, No.7 Xiongyu Road, Tangxiachong Community, Yanluo Street, Baoan District, Shenzhen
EUT: Power Bank
Trade Mark: N/A
Model Number: ZHX-PB24
Date of Receipt: Jan. 03, 2024
Test Date: Jan. 03, 2024 - Jan. 18, 2024
Date of Report: Jan. 18, 2024
Prepared By: Shenzhen DL Testing Technology Co., Ltd.
Address: 101-201, Building C, Shuanghuan, No.8, Baoqing Road, Baolong Industrial Zone, Baolong Street, Longgang District, Shenzhen, Guangdong, China
Applicable Standards: FCC PART 15 Subpart C
ANSI C63.10:2013
Test Result: Pass
Report Number: DL-20240118042E

Prepared (Engineer): Alisa Song

Reviewer (Supervisor): Jack Bu

Approved (Manager): Jade Yang



This test report is based on a single evaluation of one sample of above mentioned products. It is not permitted to be duplicated in extracts without written approval of Shenzhen DL Testing Technology Co., Ltd.



TABLE OF CONTENT

	Page
Test Report Declaration	
1. VERSION	3
2. TEST SUMMARY	3
3. GENERAL INFORMATION	4
4. TEST INSTRUMENT USED.....	6
5. CONDUCTED EMISSION TEST.....	7
6. RADIATION EMISSION TEST.....	11
7. BANDWIDTH TEST	19
8. SETUP PHOTOGRAPHS	20
9. EUT PHOTOGRAPHS	20

**1. VERSION**

Version No.	Date	Description
00	Jan. 18, 2024	Original

2. TEST SUMMARY

EMC Emission			
Test Item	Section in CFR 47	Result	Remark
AC Power Line Conducted Emission	15.207	PASS	
Spurious Emission	15.209(a)(f)	PASS	
20dB Bandwidth	15.215	PASS	
Antenna requirement	15.203	PASS	

NOTE:

(1) "N/A" denotes test is not applicable in this Test Report

(2) Test Facility: Shenzhen DL Testing Technology Co., Ltd.

Address: 101-201, Building C, Shuanghuan, No.8, Baoqing Road, Baolong Industrial Zone,
Baolong Street, Longgang District, Shenzhen, Guangdong, China



3. GENERAL INFORMATION

3.1 Description of Device (EUT)

Product Name: Power Bank
Trade Mark: N/A
Model No.: ZHX-PB24
Model Difference: N/A
Serial No.: N/A
Hardware version: H1.0
Software version: S1.0
Operation Frequency: 115kHz ~ 205KHz
Modulation type: MSK
Antenna Type: Inductive loop coil Antenna
Antenna gain: 0dBi
Power supply: USB-C Input: 5V/3A, 9V/2A
USB-C Output: 5V/3A, 9V/2.22A, 12V/1.5A
USB-A Output: 4.5V/5A, 5V/3A, 9V/2.2A, 12V/1.5A
Wireless Output: 5W/7.5W/10W/15W
Total Output: 5V/3A
Battery capacity: 10000mAh/3.85V/38.5Wh

3.2 Tested System Details

None.

3.3 Block Diagram of Test Set-up

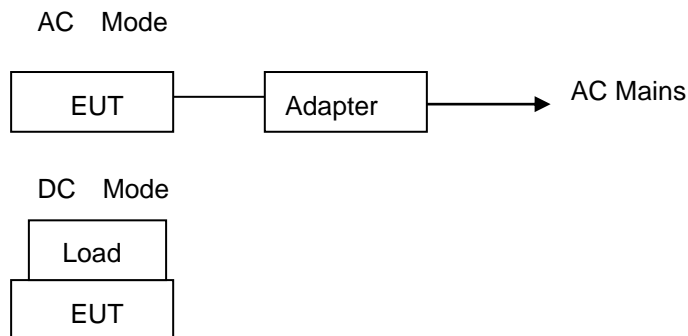



3.4 Test Mode Description

- Mode1. USB-C Input+Mobile phone wireless charging Output Mode(Full Load, 1%/50%/99%)
- Mode2. USB-C Input+Mobile phone wireless charging Output Mode(Half Load, 1%/50%/99%)
- Mode3. USB-C Input+Mobile phone wireless charging Output Mode(No Load, 1%/50%/99%)
- Mode4. USB-C Output+Mobile phone wireless charging Output Mode(Full Load, 1%/50%/99%)
- Mode5. USB-C Output+Mobile phone wireless charging Output Mode(Half Load, 1%/50%/99%)
- Mode6. USB-C Output+Mobile phone wireless charging Output Mode(No Load, 1%/50%/99%)
- Mode7. USB-A Output+Mobile phone wireless charging Output Mode(Full Load, 1%/50%/99%)
- Mode8. USB-A Output+Mobile phone wireless charging Output Mode(Half Load, 1%/50%/99%)
- Mode9. USB-A Output+Mobile phone wireless charging Output Mode(No Load, 1%/50%/99%)
- Mode10. USB-C Output Mode (Full Load)
- Mode11. USB-C Output Mode (Half Load)
- Mode12. USB-C Output Mode (No Load)
- Mode13. USB-A Output Mode (Full Load)
- Mode14. USB-A Output Mode (Half Load)
- Mode15. USB-A Output Mode (No Load)
- Mode16. Mobile phone wireless charging Output Mode(Full Load, 1%/50%/99%)
- Mode17. Mobile phone wireless charging Output Mode(Half Load, 1%/50%/99%)
- Mode18. Mobile phone wireless charging Output Mode(No Load, 1%/50%/99%)

Note: 1. We have evaluated 1%, 50% and 99% battery charging mode, and the worst mode (99%) is showed in this report.

2. All modes have been tested, and the report only shows the results of the Conducted Emission(worst mode1) and Spurious Emission(worst mode1/ worst mode16).

3.5 Test Auxiliary Equipment

Adapter (Provide by test lab):

Manufacturer: XIAOMI

Model: AD65G

I/P: AC 100-240V 50/60Hz

O/P: DC 5V/3A, DC 9V/3A, DC 10V/5A, DC 12V/3A,

DC 15V/3A, DC 20V/3.25A

Mobile phone (Provide by test lab):

Manufacturer: SAMSUNG

Model: Galaxy S21 5G

Watch (Provide by test lab):

Manufacturer: Apple

Model: Series 6

3.6 Test Uncertainty

Conducted Emission Uncertainty(150KHz-30MHz)	:	±2.56dB
20dB Bandwidth	:	±0.5kHz
Radiated Emission Uncertainty(9KHz-1GHz)	:	±3.24dB

**4. TEST INSTRUMENT USED****For Conducted Emission Test (843 Shielded Room)**

Equipment	Manufacturer	Model	Serial	Last Cal.	Next Cal.
843 Shielded Room	ChengYu	843 Room	843	Sep. 20, 2022	Sep. 19, 2025
EMI Receiver	R&S	ESR	101421	Nov. 04, 2023	Nov. 03, 2024
LISN	R&S	ENV216	102417	Nov. 04, 2023	Nov. 03, 2024
Clamp	COM-POWER	CLA-050	431071	Nov. 04, 2023	Nov. 03, 2024
3-Loop Antenna	DAZE	ZN30401	13021	Nov. 04, 2023	Nov. 03, 2024
ISN T8	Schwarzbeck	NTFM 8158	101135	Nov. 04, 2023	Nov. 03, 2024
ISN T5	Schwarzbeck	NTFM 8158	101136	Nov. 04, 2023	Nov. 03, 2024
843 Cable 1#	ChengYu	CE Cable	001	Nov. 04, 2023	Nov. 03, 2024
843 Cable 1#	ChengYu	CE Cable	002	Nov. 04, 2023	Nov. 03, 2024

For Radiated Emission Test (966 chamber)

Equipment	Manufacturer	Model	Serial	Last Cal.	Next Cal.
966 Chamber	ChengYu	966 Room	966	Sep. 20, 2022	Sep. 19, 2025
Spectrum Analyzer	Agilent	E4408B	MY50140780	Nov. 04, 2023	Nov. 03, 2024
EMI Receiver	R&S	ESRP7	101393	Nov. 04, 2023	Nov. 03, 2024
Amplifier	Schwarzbeck	BBV9743B	00153	Nov. 04, 2023	Nov. 03, 2024
Amplifier	EMEC	EM01G8GA	00270	Nov. 04, 2023	Nov. 03, 2024
Broadband Trilog Antenna	Schwarzbeck	VULB9162	00306	Nov. 04, 2023	Nov. 03, 2024
Horn Antenna	Schwarzbeck	BBHA9120D	02139	Nov. 04, 2023	Nov. 03, 2024
Loop Antenna	ZHINAN	ZN30900A	/	Nov. 04, 2023	Nov. 03, 2024
966 Cable 1#	ChengYu	966	004	Nov. 04, 2023	Nov. 03, 2024
966 Cable 2#	ChengYu	966	003	Sep. 20, 2022	Sep. 19, 2025

5. CONDUCTED EMISSION TEST

5.1 Block Diagram of Test Setup

For Mains Terminals Test

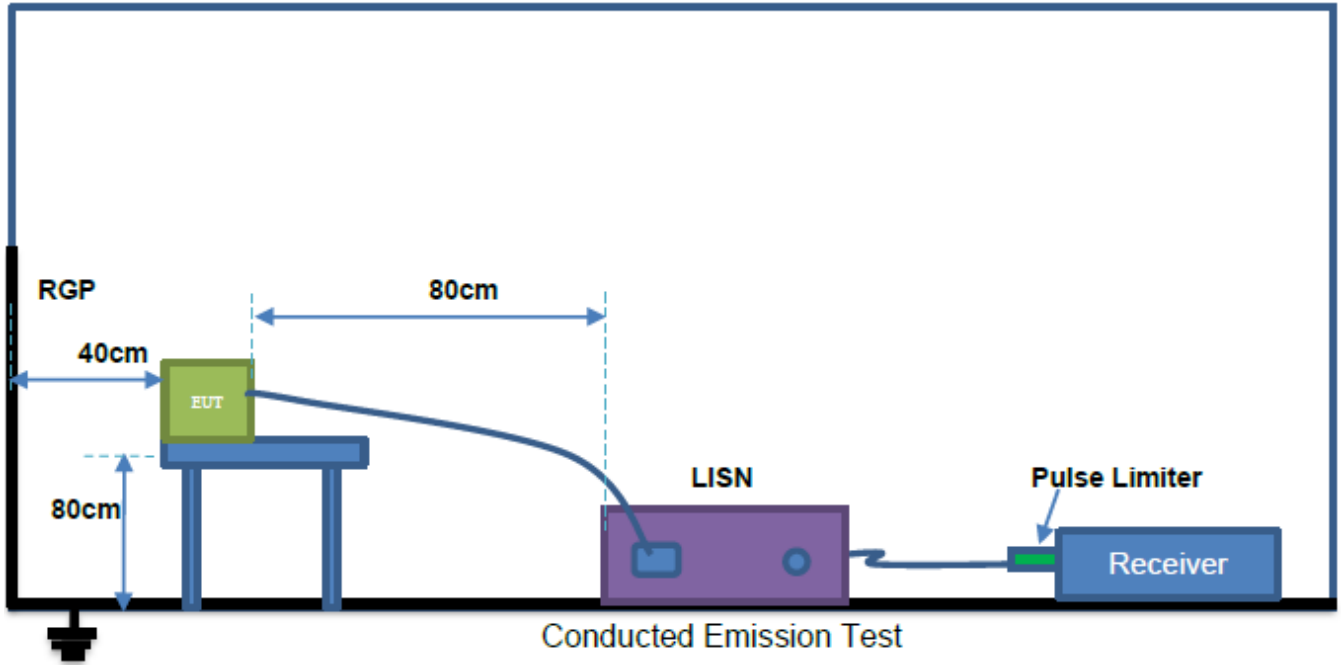

5.2 Test Standard and Limit

FCC Part 15 Subpart C

Frequency MHz	Limits dB(μV)	
	Quasi-peak Level	Average Level
0.15~0.50	66 ~ 56*	55 ~ 46*
0.50~5.00	56	46
5.00~30.00	60	50

Notes: 1. *Decreasing linearly with logarithm of frequency.

2. The lower limit shall apply at the transition frequencies.

5.3 EUT Configuration on Test

The following equipment's are installed on conducted emission test to meet FCC Part 15 Subpart C requirement and operating in a manner which tends to maximize its emission characteristics in a normal application.

5.4 Operating Condition of EUT

5.4.1 Setup the EUT and simulators as shown in Section 5.1.

5.4.2 Turn on the power of all equipments.

5.4.3 Let the EUT work in test modes and test it.



5.5 Test Procedure

The EUT is put on the table and connected to the AC mains through a Artificial Mains Network (AMN) or ISN. This provided a 50ohm coupling impedance for the tested equipments. Both sides of AC line are checked to find out the maximum conducted emission levels according to the **ANSI C63.10** regulations during conducted emission test.

The bandwidth of the test receiver (R&S Test Receiver ESR) is set at 10KHz.

The frequency range from 150 KHz to 30 MHz is investigated.

Notes:

- 1.An initial pre-scan was performed on the line and neutral lines with peak detector.
- 2.Quasi-Peak and Average measurement were performed at the frequencies with maximized peak emission.
- 3.Mesurement Level = Reading level + Correct Factor

5.6 Test Result

PASS

Please refer to the following page.



Conducted Emission Test Data			
Temperature:	24.5 °C	Relative Humidity:	54%
Pressure:	1009hPa	Phase:	Line
Test Voltage:	AC 120V/60Hz	Test Mode:	Mode 1(Mobile)

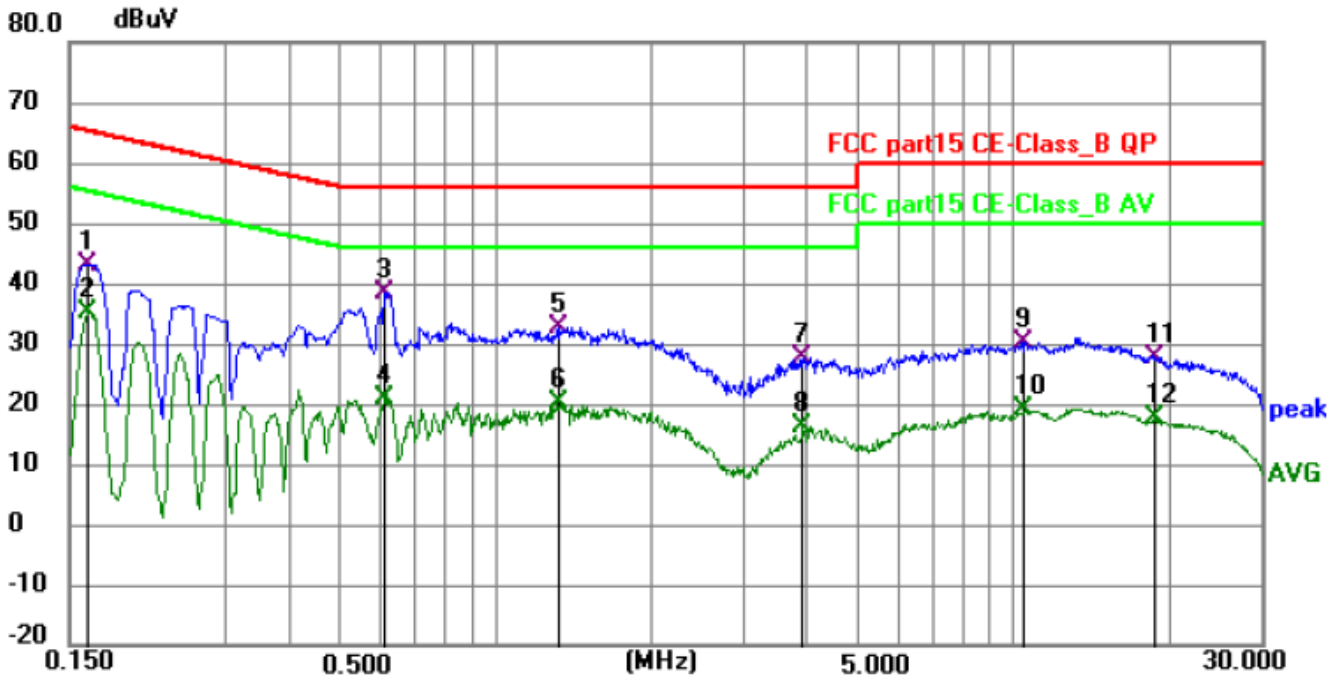

No.	Frequency (MHz)	Reading (dBuV)	Factor (dB)	Level (dBuV)	Limit (dBuV)	Margin (dB)	Detector	P/F	Remark
1	0.1635	32.66	10.27	42.93	65.28	-22.35	QP	P	
2	0.1635	25.01	10.27	35.28	55.28	-20.00	AVG	P	
3 *	0.6134	29.03	9.39	38.42	56.00	-17.58	QP	P	
4	0.6134	11.60	9.39	20.99	46.00	-25.01	AVG	P	
5	1.3290	23.17	9.53	32.70	56.00	-23.30	QP	P	
6	1.3290	10.74	9.53	20.27	46.00	-25.73	AVG	P	
7	3.9210	17.91	9.84	27.75	56.00	-28.25	QP	P	
8	3.9210	6.46	9.84	16.30	46.00	-29.70	AVG	P	
9	10.4910	20.21	10.12	30.33	60.00	-29.67	QP	P	
10	10.4910	8.91	10.12	19.03	50.00	-30.97	AVG	P	
11	18.7393	17.28	10.35	27.63	60.00	-32.37	QP	P	
12	18.7393	7.21	10.35	17.56	50.00	-32.44	AVG	P	



Conducted Emission Test Data			
Temperature:	24.5 °C	Relative Humidity:	54%
Pressure:	1009hPa	Phase:	Neutral
Test Voltage:	AC 120V/60Hz	Test Mode:	Mode 1(Mobile)

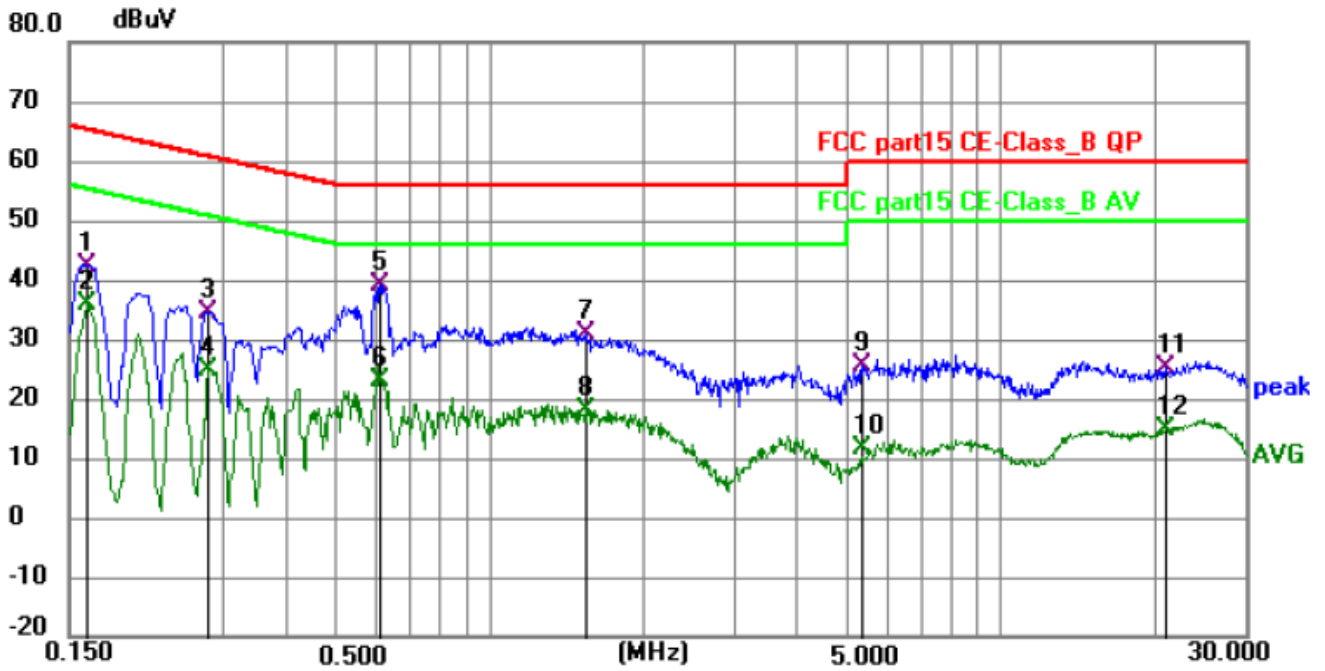

No.	Frequency (MHz)	Reading (dBuV)	Factor (dB)	Level (dBuV)	Limit (dBuV)	Margin (dB)	Detector	P/F	Remark
1	0.1635	32.37	9.99	42.36	65.28	-22.92	QP	P	
2	0.1635	25.84	9.99	35.83	55.28	-19.45	AVG	P	
3	0.2805	25.38	9.04	34.42	60.80	-26.38	QP	P	
4	0.2805	15.84	9.04	24.88	50.80	-25.92	AVG	P	
5 *	0.6090	29.91	9.31	39.22	56.00	-16.78	QP	P	
6	0.6090	13.90	9.31	23.21	46.00	-22.79	AVG	P	
7	1.5360	21.02	9.72	30.74	56.00	-25.26	QP	P	
8	1.5360	8.45	9.72	18.17	46.00	-27.83	AVG	P	
9	5.3563	15.58	10.09	25.67	60.00	-34.33	QP	P	
10	5.3563	1.58	10.09	11.67	50.00	-38.33	AVG	P	
11	20.9983	14.51	10.60	25.11	60.00	-34.89	QP	P	
12	20.9983	4.05	10.60	14.65	50.00	-35.35	AVG	P	

6. RADIATION EMISSION TEST

6.1 Block Diagram of Test Setup

Radiated Emission Test-Up Frequency Below 30MHz

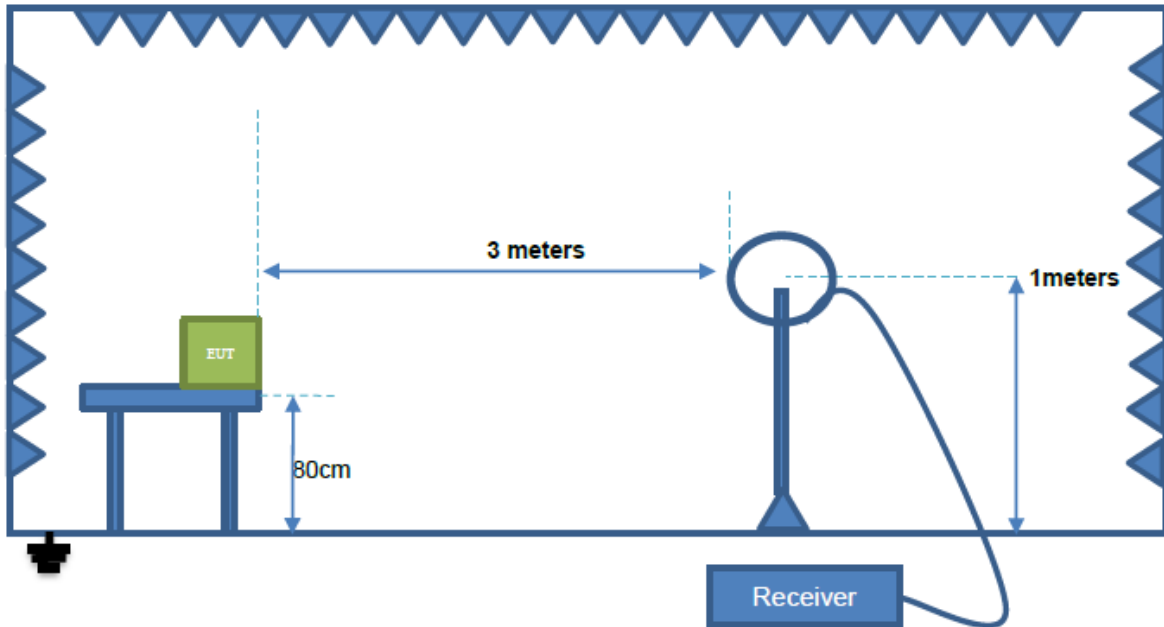

Radiation Test (9k - 30MHz)

Below 1GHz

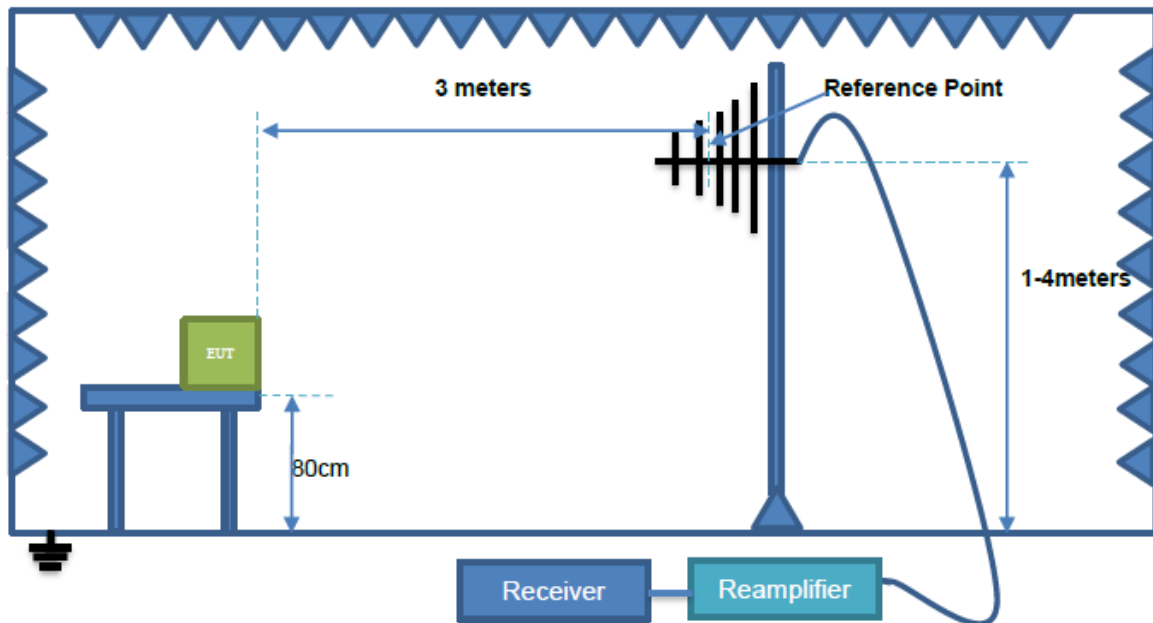

Radiation Test (30MHz – 1GHz)

6.2 Test Standard and Limit

FCC Part 15 Subpart C



Limits for frequency below 30MHz

Frequency	Limit (uV/m)	Measurement Distance(m)	Remark
0.009-0.090	2400/F(kHz)	300	AVERAGE
0.090-0.110	2400/F(kHz)	300	Quasi-peak Value
0.110-0.490	2400/F(kHz)	300	AVERAGE
0.490-1.705	24000/F(kHz)	30	Quasi-peak Value
1.705-30	30	30	Quasi-peak Value

Above 30MHz

Frequency (MHz)	Distance (Meters)	Field Strengths Limits (dB μ V/m)	Remark
30 ~ 88	3	40.0	Quasi-peak Value
88 ~ 216	3	43.5	Quasi-peak Value
216 ~ 960	3	46.0	Quasi-peak Value
960 ~ 1000	3	54.0	Quasi-peak Value
Above 1000	3	74.0	PEAK
		54.0	AVERAGE

Remark:

(1) The smaller limit shall apply at the cross point between two frequency bands.

(2) Distance refers to the distance in meters between the measuring instrument, antenna and the closed point of any part of the device or system.

6.3 EUT Configuration on Test

The FCC Part 15 Subpart C regulations test method must be used to find the maximum emission during radiated emission test.

The configuration of EUT is the same as used in conducted emission test.

Please refer to Section 5.3.

6.4 Operating Condition of EUT

Same as conducted emission test, which is listed in Section 5.4 except the test set up replaced as Section 6.2.

6.5 Test Procedure

1) The radiated emissions test was conducted in a semi-anechoic chamber.

2) The tabletop EUT was placed upon a non-metallic table 0.8m above the ground reference plane. And for floor-standing arrangement, the EUT was placed on the horizontal ground reference plane, but separated from metallic contact with the ground reference plane by 0.1m of insulation.

3) Before final measurements of radiated emissions, a pre-scan was performed in the spectrum mode with the peak detector to find out the maximum emissions spectrum plots of the EUT.

4) The frequencies of maximum emission were determined in the final radiated emissions measurement. At each frequency, the EUT was rotated 360°, and the antenna was raised and lowered from 1 to 4 meters in order to determine the maximum disturbance. Measurements were performed for both horizontal and vertical antenna polarization.

5) The bandwidth setting on the field strength meter (R&S Test Receiver ESCI) is set at 120KHz.

6) The frequency range from 30MHz to 1000MHz is checked.

6.6 Test Result



PASS, Please refer to the following page.

Radiation Emission Test Data 9 kHz~30 MHz			
Temperature:	24.5 °C	Relative Humidity:	54%
Pressure:	1009hPa	Polarization:	/
Test Voltage:	AC 120V/60Hz	Test Mode:	Mode 1(Mobile)

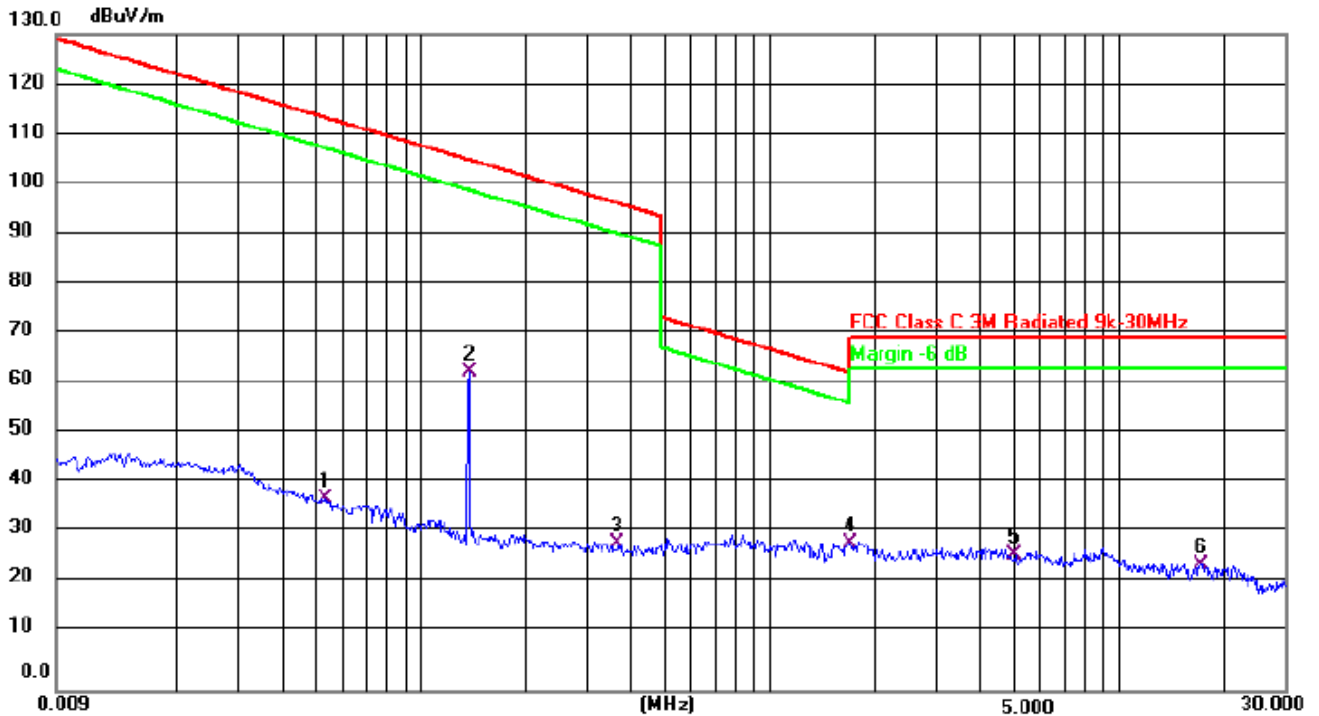

Frequency (MHz)	Meter Reading (dBμV)	Factor (dB)	Emission Level (dBμV/m)	Limits (dBμV/m)	Margin (dB)	Detector Type
0.0531	37.18	10.22	47.4	113.46	-66.06	Peak
0.1373	62.17	10.47	72.64	105.14	-32.5	Peak
0.3664	27.27	10.88	38.15	96.55	-58.4	Peak
1.6975	28.16	10.23	38.39	63.04	-24.65	Peak
5.0357	25.15	10.18	35.33	70	-34.67	Peak
17.1412	22.58	10.69	33.27	70	-36.73	Peak

Note:

Pre-scan in the all of mode, the worst case in of was recorded.

Factor = antenna factor + cable loss – pre-amplifier.

Margin = Emission Level(Meter Reading+ Factor) - Limit.



Radiation Emission Test Data 9 kHz~30 MHz			
Temperature:	24.5 °C	Relative Humidity:	54%
Pressure:	1009hPa	Polarization:	/
Test Voltage:	DC 3.85V	Test Mode:	Mode 16(Portable)

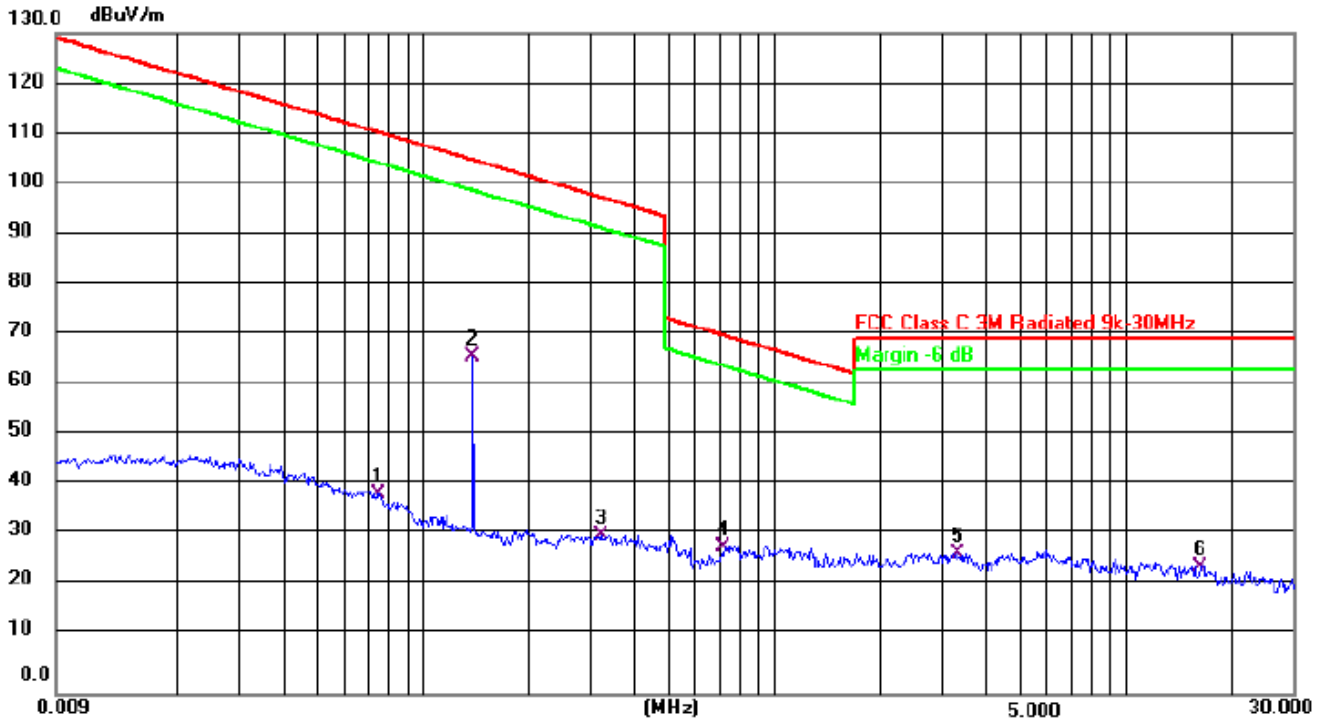

Frequency (MHz)	Meter Reading (dBμV)	Factor (dB)	Emission Level (dBμV/m)	Limits (dBμV/m)	Margin (dB)	Detector Type
0.0752	38.38	10.22	48.6	110.41	-61.81	Peak
0.1385	66.39	10.47	76.86	105.06	-28.2	Peak
0.3190	29.34	10.88	40.22	97.76	-57.54	Peak
0.7186	28.00	10.23	38.23	70.62	-32.39	Peak
3.3298	26.18	10.18	36.36	70	-33.64	Peak
16.3270	22.75	10.69	33.44	70	-36.56	Peak

Note:

Pre-scan in the all of mode, the worst case in of was recorded.

Factor = antenna factor + cable loss – pre-amplifier.

Margin = Emission Level(Meter Reading+ Factor) - Limit.



Radiation Emission Test Data			
Temperature:	24.5 °C	Relative Humidity:	54%
Pressure:	1009hPa	Polarization:	Horizontal
Test Voltage:	AC 120V/60Hz	Test Mode:	Mode 1(Mobile)

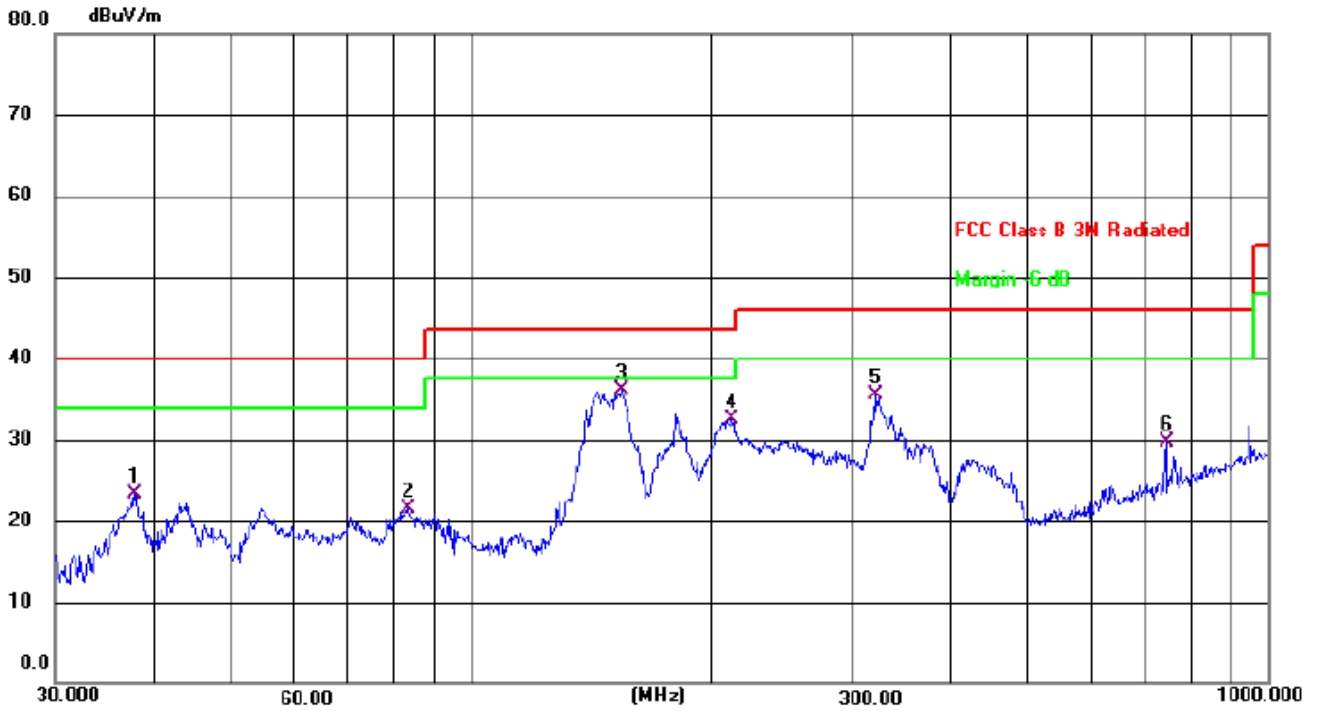

No.	Mk.	Freq. MHz	Reading Level dBuV	Correct Factor dB	Measure- ment dBuV/m	Limit dB/m	Margin dB	Detector
1		37.8121	37.61	-14.32	23.29	40.00	-16.71	QP
2		83.2298	38.94	-17.38	21.56	40.00	-18.44	QP
3	*	154.2786	53.75	-17.58	36.17	43.50	-7.33	QP
4		212.2695	46.76	-14.24	32.52	43.50	-10.98	QP
5		321.0608	46.65	-11.07	35.58	46.00	-10.42	QP
6		744.8661	32.89	-3.15	29.74	46.00	-16.26	QP



Radiation Emission Test Data			
Temperature:	24.5 °C	Relative Humidity:	54%
Pressure:	1009hPa	Polarization:	Vertical
Test Voltage:	AC 120V/60Hz	Test Mode:	Mode 1(Mobile)

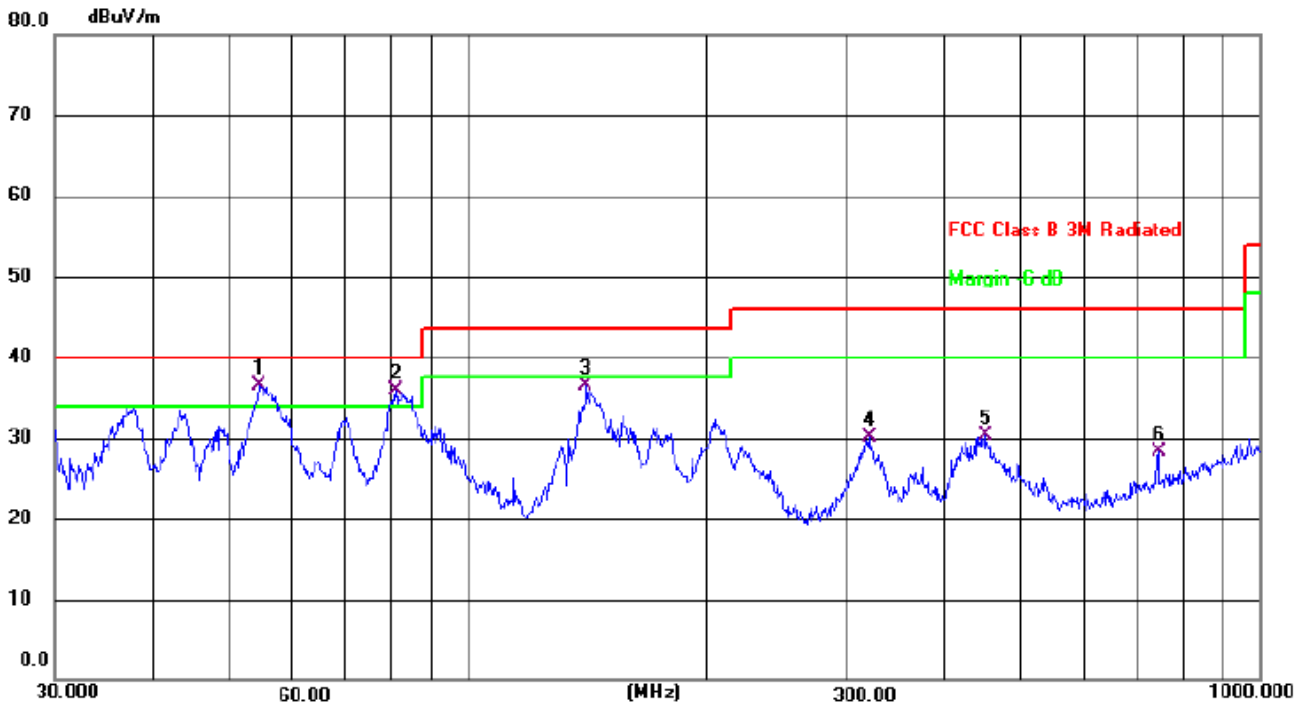

No.	Mk.	Freq. MHz	Reading Level dBuV	Correct Factor dB	Measure- ment dBuV/m	Limit dB/m	Margin dB	Detector
1	*	54.4516	49.44	-12.99	36.45	40.00	-3.55	QP
2	!	80.9275	53.30	-17.49	35.81	40.00	-4.19	QP
3		140.8351	53.88	-17.44	36.44	43.50	-7.06	QP
4		321.0608	41.09	-11.07	30.02	46.00	-15.98	QP
5		449.5558	38.89	-8.67	30.22	46.00	-15.78	QP
6		744.8661	31.48	-3.15	28.33	46.00	-17.67	QP

Remarks:

1. Final Level = Receiver Read level + Correct factor (Antenna Factor + Cable Loss – Pre-amplifier Factor)
2. The emission levels of other frequencies are very lower than the limit and not show in test report.



Radiation Emission Test Data			
Temperature:	24.5 °C	Relative Humidity:	54%
Pressure:	1009hPa	Polarization:	Horizontal
Test Voltage:	DC 3.85V	Test Mode:	Mode 16(Portable)

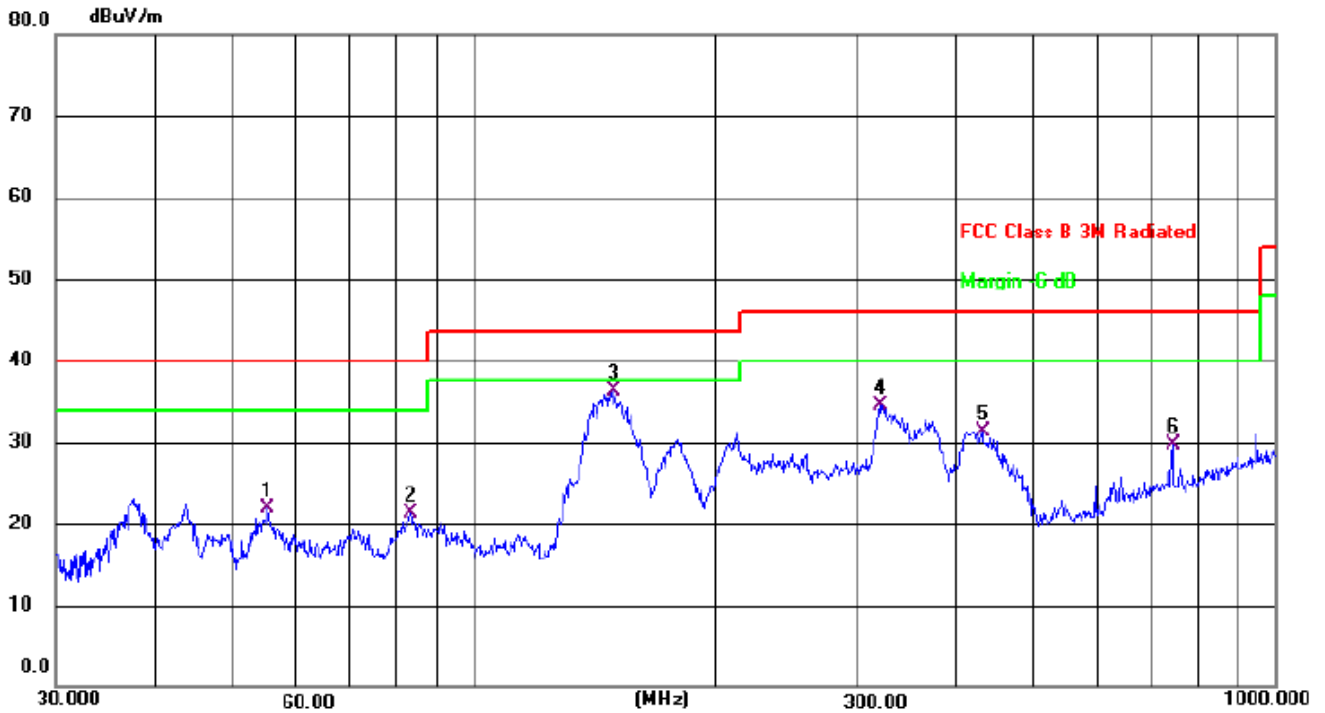

No.	Mk.	Freq. MHz	Reading Level dBuV	Correct Factor dB	Measure- ment dBuV/m	Limit dB/m	Margin dB	Detector
1		55.2207	34.83	-12.94	21.89	40.00	-18.11	QP
2		83.2298	38.60	-17.38	21.22	40.00	-18.78	QP
3	*	149.4857	54.06	-17.82	36.24	43.50	-7.26	QP
4		321.0608	45.59	-11.07	34.52	46.00	-11.48	QP
5		431.0316	40.41	-9.09	31.32	46.00	-14.68	QP
6		744.8661	32.78	-3.15	29.63	46.00	-16.37	QP



Radiation Emission Test Data			
Temperature:	24.5 °C	Relative Humidity:	54%
Pressure:	1009hPa	Polarization:	Vertical
Test Voltage:	DC 3.85V	Test Mode:	Mode 16(Portable)

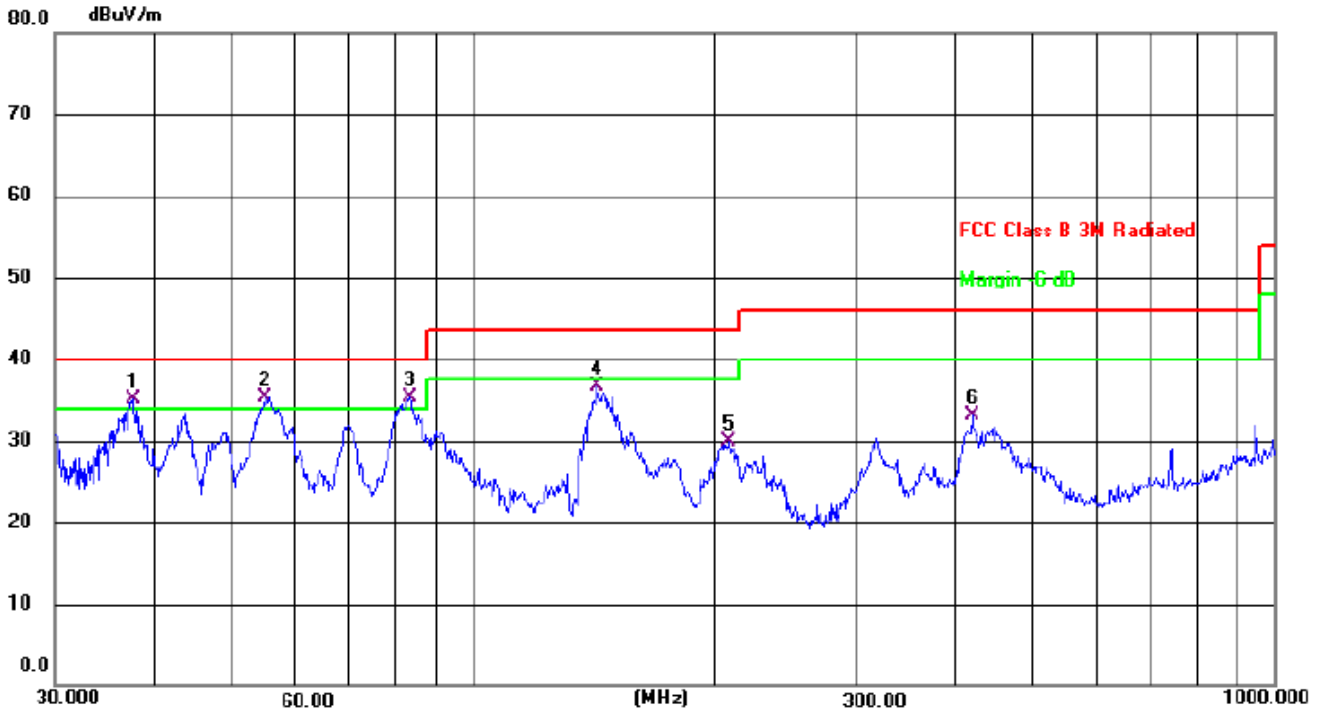

No.	Mk.	Freq. MHz	Reading Level dBuV	Correct Factor dB	Measure- ment dBuV/m	Limit dB/m	Margin dB	Detector
1	!	37.5479	49.45	-14.38	35.07	40.00	-4.93	QP
2	*	55.0274	48.31	-12.95	35.36	40.00	-4.64	QP
3	!	83.2298	52.74	-17.38	35.36	40.00	-4.64	QP
4		142.8243	54.31	-17.53	36.78	43.50	-6.72	QP
5		208.5803	44.25	-14.39	29.86	43.50	-13.64	QP
6		419.1081	42.40	-9.35	33.05	46.00	-12.95	QP

Remarks:

1. Final Level = Receiver Read level + Correct factor (Antenna Factor + Cable Loss – Preamplifier Factor)
2. The emission levels of other frequencies are very lower than the limit and not show in test report.



7. BANDWIDTH TEST

7.1 TEST SETUP

1. Set RBW = 3KHz.
2. Set the video bandwidth (VBW) ≥ 3 x RBW.
3. Detector = Peak.
4. Trace mode = max hold.
5. Sweep = auto couple.
6. Allow the trace to stabilize.
7. Measure the maximum width of the emission that is constrained by the frequencies associated with the two outermost amplitude points (upper and lower frequencies) that are attenuated by 20 dB relative to the maximum level measured in the fundamental emission.

7.2 TEST SETUP

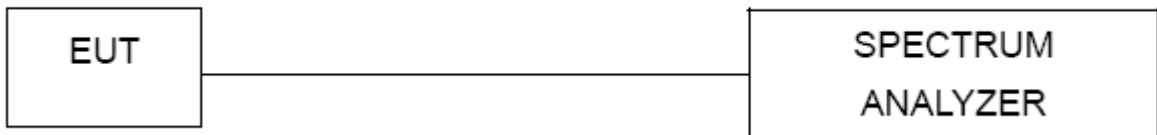

7.3 TEST Result

Frequency (KHz)	20dB bandwidth (KHz)	Result
138	8.172	Pass

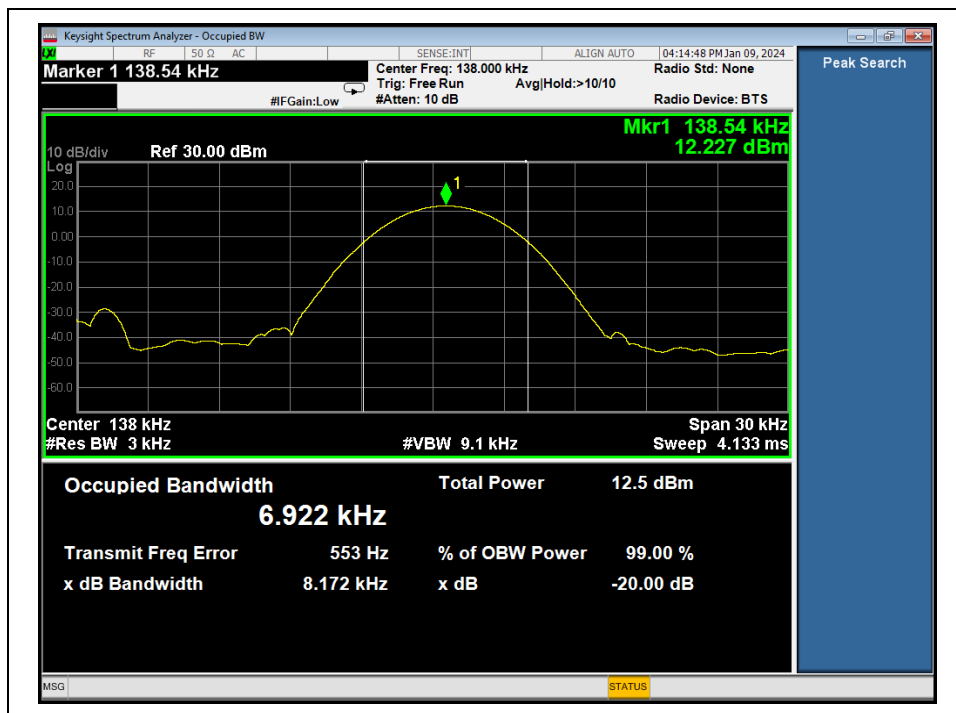



8. SETUP PHOTOGRAPHS

Reference to the setup photo for details.

9. EUT PHOTOGRAPHS

Reference to the external and internal photo for details.

******* END OF REPORT *******