

## TEST REPORT

Test report no.: 1-2751/21-01-02



### Testing laboratory

**CTC advanced GmbH**

Untertuerkheimer Strasse 6 – 10

66117 Saarbruecken / Germany

Phone: + 49 681 5 98 - 0

Fax: + 49 681 5 98 - 9075

Internet: <http://www.ctcadvanced.com>

e-mail: [mail@ctcadvanced.com](mailto:mail@ctcadvanced.com)

**Accredited Testing Laboratory:**

The testing laboratory (area of testing) is accredited according to DIN EN ISO/IEC 17025 (2005) by the Deutsche Akkreditierungsstelle GmbH (DAKKS)

The accreditation is valid for the scope of testing procedures as stated in the accreditation certificate with the registration number: D-PL-12076-01-03

### Applicant

**hiSky SCS Ltd**

24 Amal St. Park Afek, Rosh Hay'ayin

P.O.B 11363 / Israel 4809268

Phone: +972-3-6588000

Contact: Gal Diamant

e-mail: [gald@hiskysat.com](mailto:gald@hiskysat.com)

Phone: +972-3-9646144

Fax: +972-3-6587999

### Manufacturer

**hiSky SCS Ltd**

24 Amal St. Park Afek, Rosh Hay'ayin

P.O.B 11363 / Israel 4809268

### Test standard/s

47 CFR Part 25

Title 47 of the Code of Federal Regulations; Chapter I; Part 25 - Satellite Communications

### Test Item

**Kind of test item:** Dynamic Smartellite Terminal Ku 8x8 V2

**Model name:** Dynamic Terminal Ku 8X8 V2

**FCC ID:** 2A4L8-DKU8X8V2

**Frequency:** Tx: 13.75 – 14.50 GHz / Rx: 10.70 – 12.75 GHz

**Characteristics:** Tx/Rx, BPSK

**Power supply:** 100 – 240 V AC, 50/60 Hz by Power Supply, 15 V DC

**Temperature range:** -20 °C to +50 °C

This test report is electronically signed and valid without handwriting signature. For verification of the electronic signatures, the public keys can be requested at the testing laboratory.

### Test report authorized:

Meheza Walla  
Lab Manager  
Radio Communications & EMC

### Test performed:

Thomas Vogler  
Lab Manager  
Radio Communications & EMC

## 1 Table of contents

1	Table of contents .....	2
2	General information .....	3
2.1	Notes and disclaimer.....	3
2.2	Application details.....	3
3	Test standards and references.....	4
3.1	Test standards.....	4
3.2	Measurement guidance.....	4
3.3	Reporting statements of conformity – decision rule .....	5
4	Test environment.....	5
5	Test laboratories sub-contracted.....	5
6	Test item.....	6
6.1	General Description.....	6
6.2	List of components.....	7
6.3	Antenna system(s) .....	7
6.4	Operating conditions.....	7
6.5	Additional information.....	7
7	Description of the test setup .....	8
7.1	Shielded semi anechoic chamber.....	9
7.2	Shielded fully anechoic chamber.....	11
7.3	Radiated measurements > 1 GHz (on axis) / > 18 GHz (off axis) .....	13
7.4	Radiated measurements > 50 GHz.....	13
8	Sequence of testing .....	15
8.1	Sequence of testing radiated spurious 9 kHz to 30 MHz .....	15
8.2	Sequence of testing radiated spurious 30 MHz to 1 GHz.....	16
8.3	Sequence of testing radiated spurious 1 GHz to 18 GHz.....	17
8.4	Sequence of testing radiated spurious above 18 GHz.....	18
8.5	Sequence of testing radiated spurious above 50 GHz with external mixers .....	19
9	Measurement results .....	20
9.1	Summary.....	20
9.2	RF power output / Power limits.....	21
9.3	EIRP Spectral Density .....	22
9.4	Occupied bandwidth .....	23
9.5	Emissions limitations (conducted emissions) .....	24
9.6	Emissions limits (radiated emissions) .....	25
9.7	Transmitter frequency tolerance .....	26
10	Glossary .....	28
11	Document history.....	29
12	Accreditation Certificate – D-PL-12076-01-05 .....	29

## 2 General information

### 2.1 Notes and disclaimer

The test results of this test report relate exclusively to the test item specified in this test report. CTC advanced GmbH does not assume responsibility for any conclusions and generalizations drawn from the test results with regard to other specimens or samples of the type of the equipment represented by the test item.

The test report may only be reproduced or published in full. Reproduction or publication of extracts from the report requires the prior written approval of CTC advanced GmbH.

The testing service provided by CTC advanced GmbH has been rendered under the current "General Terms and Conditions for CTC advanced GmbH".

CTC advanced GmbH will not be liable for any loss or damage resulting from false, inaccurate, inappropriate or incomplete product information provided by the customer.

Under no circumstances does the CTC advanced GmbH test report include any endorsement or warranty regarding the functionality, quality or performance of any other product or service provided.

Under no circumstances does the CTC advanced GmbH test report include or imply any product or service warranties from CTC advanced GmbH, including, without limitation, any implied warranties of merchantability, fitness for purpose, or non-infringement, all of which are expressly disclaimed by CTC advanced GmbH.

All rights and remedies regarding vendor's products and services for which CTC advanced GmbH has prepared this test report shall be provided by the party offering such products or services and not by CTC advanced GmbH. In no case this test report can be considered as a Letter of Approval.

This test report is electronically signed and valid without handwritten signature. For verification of the electronic signatures, the public keys can be requested at the testing laboratory.

### 2.2 Application details

Date of receipt of order:	2021-06-23
Date of receipt of test item:	2021-09-10
Start of test:	2021-09-13
End of test:	2021-09-23
Person(s) present during the test:	Mr. Benny Versano



### 3 Test standards and references

#### 3.1 Test standards

Test standard	Date	Test standard description
47 CFR Part 25	2021-03	Title 47 of the Code of Federal Regulations; Chapter I; Part 25 - Satellite Communications

#### 3.2 Measurement guidance

Guidance	Version	Description
ANSI C63.4-2014	-/-	American national standard for methods of measurement of radio-noise emissions from low-voltage electrical and electronic equipment in the range of 9 kHz to 40 GHz
ANSI C63.10-2013	-/-	American national standard of procedures for compliance testing of unlicensed wireless devices
ANSI C63.26-2015	-/-	American National Standard for Compliance Testing of Transmitters Used in Licensed Radio Services

Accreditation	Description	
D-PL-12076-01-05	Telecommunication FCC requirements <a href="https://www.dakks.de/as/ast/d/D-PL-12076-01-05e.pdf">https://www.dakks.de/as/ast/d/D-PL-12076-01-05e.pdf</a>	  Deutsche Akkreditierungsstelle D-PL-12076-01-05

### 3.3 Reporting statements of conformity – decision rule

Only the measured values related to their corresponding limits will be used to decide whether the equipment under test meets the requirements of the test standards listed in chapter 3.

The measurement uncertainty is mentioned in this test report, but is not taken into account - neither to the limits nor to the measurement results. Measurement results with a smaller margin to the corresponding limits than the measurement uncertainty have a potential risk of more than 5% that the decision might be wrong."

measured value, measurement uncertainty, verdict

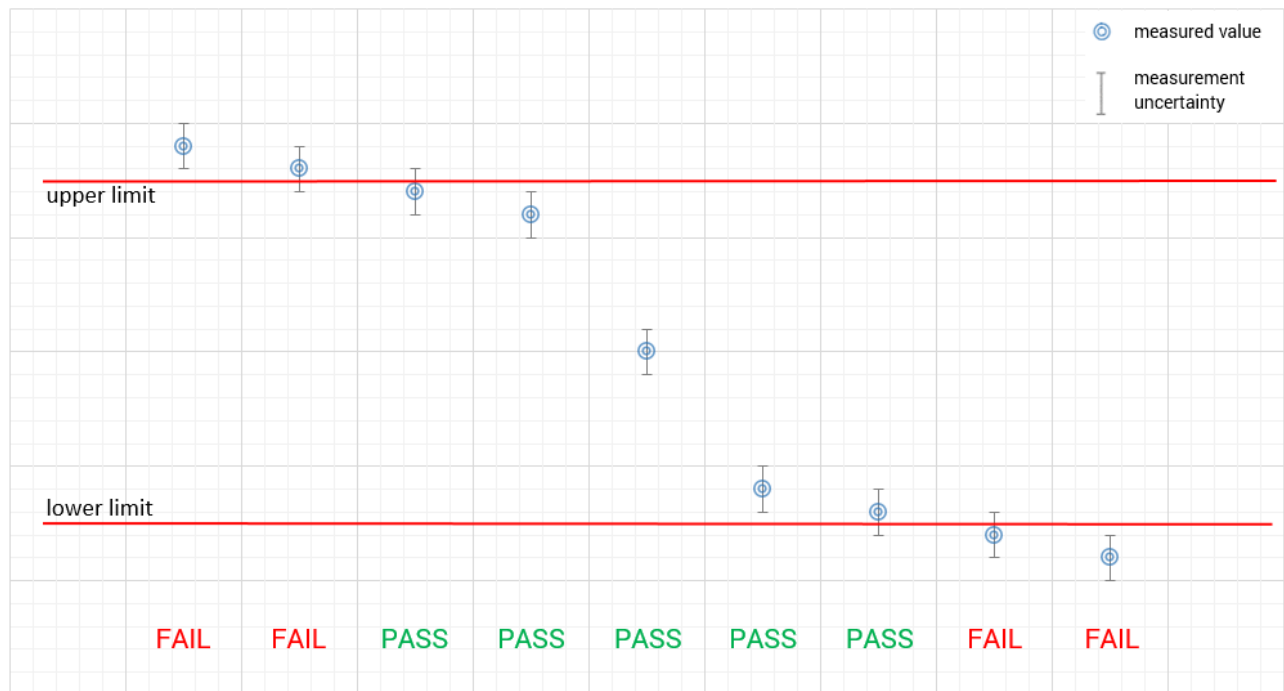

### 4 Test environment

Temperature:	T <sub>nom</sub> T <sub>max</sub> T <sub>min</sub>	+22 °C during room temperature tests +50 °C during high temperature tests -20 °C during low temperature tests
Relative humidity content:		55 %
Barometric pressure:		not relevant for this kind of testing
Power supply:	V <sub>nom</sub> V <sub>max</sub> V <sub>min</sub>	15.00 V DC 17.25 V DC 12.75 V DC

### 5 Test laboratories sub-contracted

None

## 6 Test item

### 6.1 General Description

<b>Kind of test item</b>	:	Dynamic Smartellite Terminal Ku 8x8 V2
<b>Type identification</b>	:	Dynamic Terminal Ku 8X8 V2
<b>hardware version</b>	:	2.0
<b>software version</b>	:	0.5.6
<b>firmware version</b>	:	0.5.6
<b>Frequency band</b>	:	Tx: 13.75 – 14.50 GHz / Rx: 10.70 – 12.75 GHz
<b>TX output power cond</b>	:	1 W
<b>TX output power rad.</b>	:	21 dBW nominal
<b>Att. betw. HPA/Antenna</b>	:	0 dB
<b>Type of radio transmission :</b> <b>Use of frequency spectrum :</b>	:	MF-TDMA / TDMA / SCPC
<b>Type of modulation</b>	:	BPSK 2.24 MSym/s
<b>Data rate</b>	:	13 kbit/s
<b>Channel spacing</b>	:	depends on modem
<b>Power supply</b>	:	100 – 240 V AC, 50/60 Hz with power supply 15 V DC
<b>Temperature range</b>	:	-20 °C to +50 °C

## 6.2 List of components

No.	Equipment	Manufacturer Type name	(version, model/part number)	Serial number	Note no.	tested (Y/N)
1	Dynamic IoT Ku Terminal	hiSky SCS Ltd	P/N: HSK_DKU8_IDV2 Cust. P/N E0004556-0001	29300000000094		Y
2	AC/DC Switching Adaptor	Mean Well	GST90A15-P1M	EC062Y8858		Y

**Note:**

- 1) The item can optionally be equipped with this additional component.
- 2) The item can optionally be equipped with this component instead of no. xxx.
- 3) Because of conceptional and electrical equality no. xxx was/were representatively tested as worst case.
- 4) This component corresponds with the no. xxx but it's not fully provided.
- 5) The item can be combined with this component. The test of this component is documented in test report no. xxxxx/xxxxx/xx.
- 6) This component was sufficiently taken into account, see test report no. xxxxx/xxxxx/xx.
- 7) This component is not part of the test item - it was representatively used to establish the operation and test modes.
- 8) This component is integrated repeatedly in the item because of redundancy - the redundant components were not tested because of equality to the primary parts.
- 9) This component is not relevant relating to the requirements of the test specification as well as baseband equipment - the EMC conformity and eventually the approval for connection to public telecommunication networks are only expected.

## 6.3 Antenna system(s)

The EUT contains an integrated phased array antenna for left hand and right hand circular polarization, which has a gain of 21 dBi and a half power beam width of 13° at 0° direction.  
See technical documentation of manufacturer for details.

Note: Above mentioned antenna test reports / antenna pattern must be in compliance with test standard(s) listed under section 3! Refer to customer documentation for more details.

## 6.4 Operating conditions

- Operating condition 1: 14.125 GHz (=fm, 13.755 GHz =fl, 14.495 GHz =fh)  
BPSK, power level setting 4000 in test software
- Operating condition 2: Emissions disabled  
TX off

## 6.5 Additional information

The content of the following annexes is defined in the QA. It may be that not all of the listed annexes are necessary for this report, thus some values in between may be missing.

- Test setup- and EUT-photos are included in test report: 1-0037/20-02-01\_AnnexA  
1-0037/20-02-01\_AnnexB  
1-0037/20-02-01\_AnnexD  
1-0037/20-02-01\_AnnexH
- Test plots are included in test report: 1-0037/20-02-01\_AnnexG

## 7 Description of the test setup

Typically, the calibrations of the test apparatus are commissioned to and performed by an accredited calibration laboratory. The calibration intervals are determined in accordance with the DIN EN ISO/IEC 17025. In addition to the external calibrations, the laboratory executes comparison measurements with other calibrated test systems or effective verifications. Weekly chamber inspections and range calibrations are performed. Where possible, RF generating and signaling equipment as well as measuring receivers and analyzers are connected to an external high-precision 10 MHz reference (GPS-based or rubidium frequency standard).

In order to simplify the identification of the equipment used at some special tests, some items of test equipment and ancillaries can be provided with an identifier or number in the equipment list below (Lab/Item).

### **Agenda:** Kind of Calibration

k	calibration / calibrated		EK	limited calibration
ne	not required (k, ev, izw, zw not required)		zw	cyclical maintenance (external cyclical maintenance)
ev	periodic self verification		izw	internal cyclical maintenance
Ve	long-term stability recognized		g	blocked for accredited testing
vkl!	Attention: extended calibration interval			
NK!	Attention: not calibrated		*)	next calibration ordered / currently in progress



## 7.1 Shielded semi anechoic chamber

The radiated measurements are performed in vertical and horizontal plane in the frequency range from 30 MHz to 1 GHz in semi-anechoic chambers. The EUT is positioned on a non-conductive support with a height of 0.80 m above a conductive ground plane that covers the whole chamber. The receiving antennas are conform to specifications ANSI C63. These antennas can be moved over the height range between 1.0 m and 4.0 m in order to search for maximum field strength emitted from EUT. The measurement distances between EUT and receiving antennas are indicated in the test setups for the various frequency ranges. For each measurement, the EUT is rotated in all three axes until the maximum field strength is received. The wanted and unwanted emissions are received by spectrum analyzers where the detector modes and resolution bandwidths over various frequency ranges are set according to requirement ANSI C63.

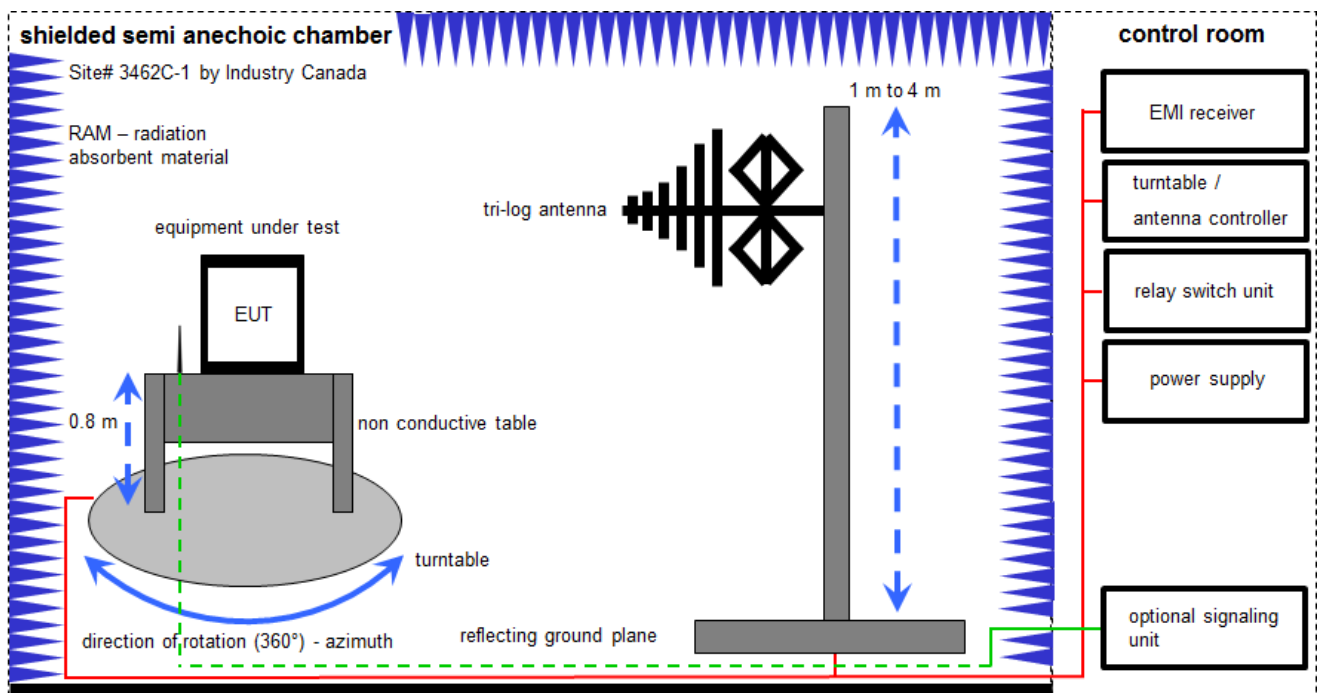

Measurement distance: tri-log antenna 10 meter

$$FS = UR + CL + AF$$

(FS-field strength; UR-voltage at the receiver; CL-loss of the cable; AF-antenna factor)

Example calculation:

$$FS [dB\mu V/m] = 12.35 [dB\mu V/m] + 1.90 [dB] + 16.80 [dB/m] = 31.05 [dB\mu V/m] (35.69 \mu V/m)$$

**Equipment table:**

No.	Lab / Item	Equipment	Type	Manufacturer	Serial No.	INV. No.	Kind of Calibration	Last Calibration	Next Calibration
1	n. a.	Switch-Unit	3488A	HP	2719A14505	300000368	ev	-/-	-/-
2	n. a.	DC power supply, 60Vdc, 50A, 1200 W	6032A	HP	2920A04466	300000580	ne	-/-	-/-
3	n. a.	Meißkabine 1	HF-Absorberhalle	MWB AG 300023		300000551	ne	-/-	-/-
4	n. a.	EMI Test Receiver	ESC13	R&S	100083	300003312	k	09.12.2020	08.12.2021
5	n. a.	Antenna Tower	Model 2175	ETS-Lindgren	64762	300003745	izw	-/-	-/-
6	n. a.	Positioning Controller	Model 2090	ETS-Lindgren	64672	300003746	izw	-/-	-/-
7	n. a.	Turntable Interface-Box	Model 105637	ETS-Lindgren	44583	300003747	izw	-/-	-/-
8	n. a.	TRILOG Broadband Test-Antenna 30 MHz - 3 GHz	VULB9163	Schwarzbeck Mess - Elektronik	318	300003696	vKI!	04.10.2019	03.10.2021
9	n. a.	Switch-Unit	3488A	HP	2719A14505	300000368	ev	-/-	-/-
10	n. a.	EMI Test Receiver	ESR3	Rohde & Schwarz	102587	300005771	k	10.12.2020	09.06.2022

## 7.2 Shielded fully anechoic chamber

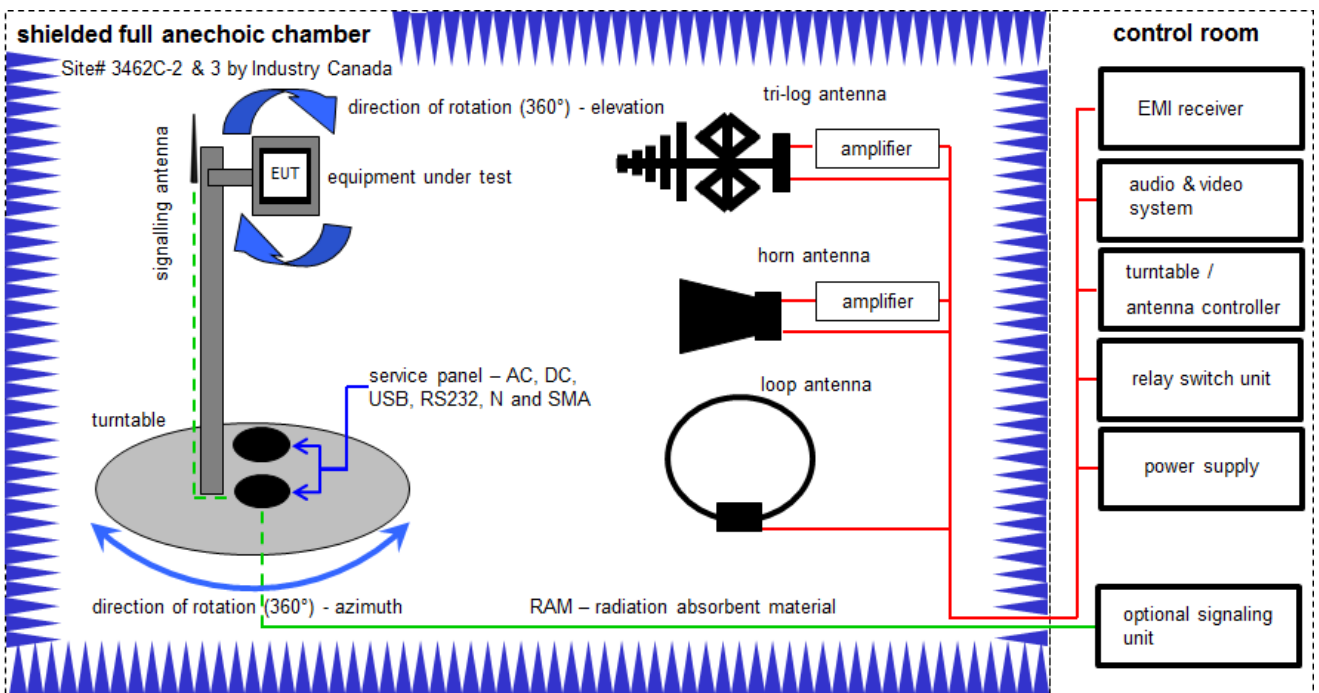

Measurement distance: tri-log antenna and horn antenna 3 meter; loop antenna 3 meter  
 BAT-EMC software version: 3.16.0.49

$$OP = AV + D - G + CA$$

(OP-radiated output power; AV-analyzer value; D-free field attenuation of measurement distance;  
 G-antenna gain+amplifier gain; CA-loss signal path)

Example calculation:

$$OP \text{ [dBm]} = -65.0 \text{ [dBm]} + 50 \text{ [dB]} - 20 \text{ [dBi]} + 5 \text{ [dB]} = -30 \text{ [dBm]} \text{ (1 } \mu\text{W)}$$

**Equipment table:**

No.	Lab / Item	Equipment	Type	Manufacturer	Serial No.	INV. No.	Kind of Calibration	Last Calibration	Next Calibration
1	n. a.	DC power supply, 60Vdc, 50A, 1200 W	6032A	HP	2818A03450	300001040	vKI!	09.12.2020	08.12.2023
2	n. a.	Active Loop Antenna 9 kHz to 30 MHz	6502	EMCO	2210	300001015	vKI!	01.07.2021	30.06.2021
3	n. a.	Anechoic chamber	FAC 3/5m	MWB / TDK	87400/02	300000996	ev	-/-	-/-
4	n. a.	TRILOG Broadband Test-Antenna 30 MHz - 3 GHz	VULB9163	Schwarzbeck Mess - Elektronik	371	300003854	vKI!	14.01.2020	13.01.2022
5	n. a.	Double-Ridged Waveguide Horn Antenna 1-18.0GHz	3115	EMCO	9709-5289	300000213	vKI!	14.07.2020	13.07.2022
6	n. a.	Switch / Control Unit	3488A	HP	*	300000199	ne	-/-	-/-
7	n. a.	Variable isolating transformer	MPL IEC625 Bus Variable isolating transformer	Erfi	91350	300001155	ne	-/-	-/-
8	n. a.	EMI Test Receiver 20Hz- 26,5GHz	ESU26	R&S	100037	300003555	k	11.12.2020	10.12.2021
9	n. a.	Highpass Filter	WHKX7.0/18G-8SS	Wainwright	19	300003790	ne	-/-	-/-
10	n. a.	Broadband Amplifier 0.5-18 GHz	CBLU5184540	CERNEX	22049	300004481	ev	-/-	-/-
11	n. a.	Broadband Amplifier 5-13 GHz	CBLU5135235	CERNEX	22010	300004491	ev	-/-	-/-
12	n. a.	4U RF Switch Platform	L4491A	Agilent Technologies	MY50000037	300004509	ne	-/-	-/-
13	n. a.	NEXIO EMV-Software	BAT EMC V3.16.0.49	EMCO		300004682	ne	-/-	-/-
14	n. a.	PC	ExOne	F+W		300004703	ne	-/-	-/-
15	n. a.	RF-Amplifier	AMF-6F06001800-30-10P-R	NARDA-MITEQ Inc	2011572	300005241	ev	-/-	-/-

### 7.3 Radiated measurements > 1 GHz (on axis) / > 18 GHz (off axis)

#### Radiated measurements > 18 GHz

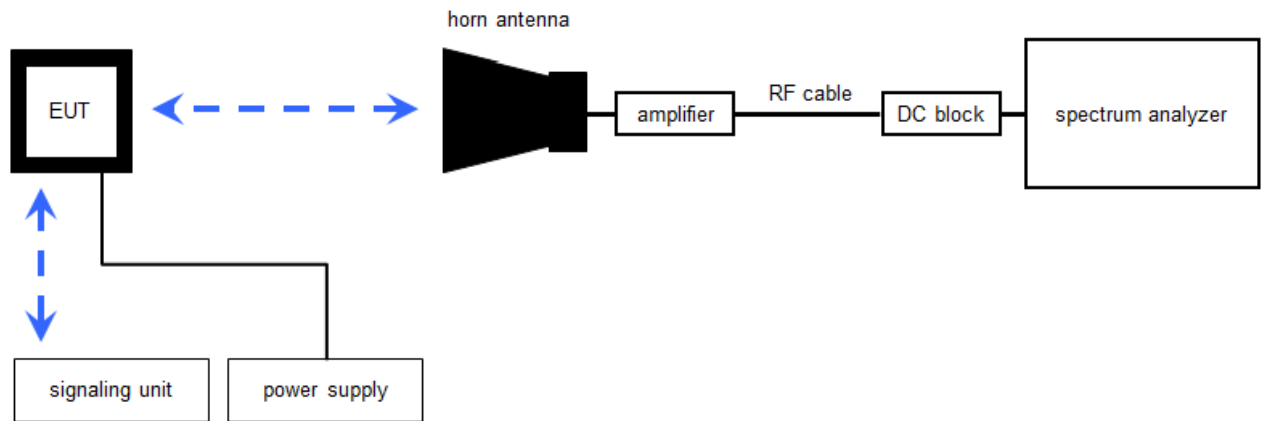

### 7.4 Radiated measurements > 50 GHz

#### Radiated measurements RF laboratory

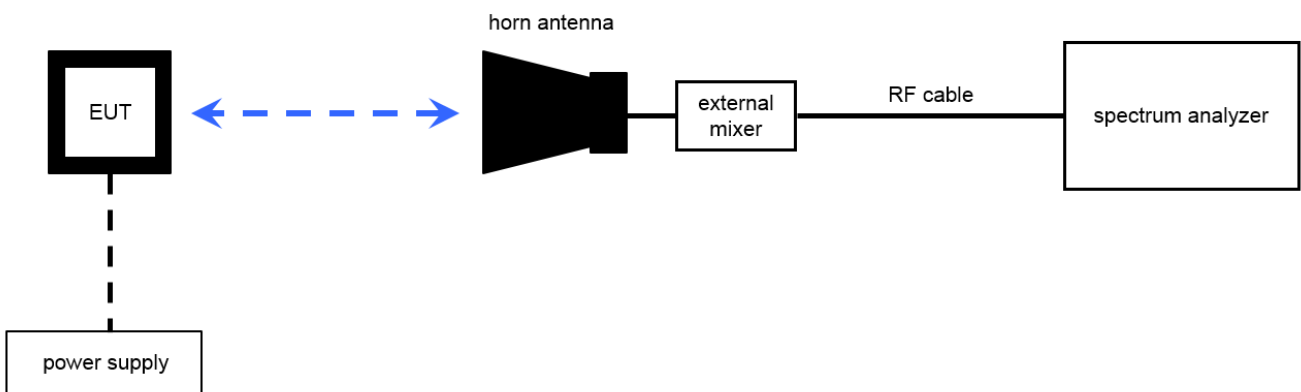

$$OP = AV + D - G$$

(OP-rad. output power; AV-analyzer value; D-free field attenuation of measurement distance; G-antenna gain)

Example calculation:

$$OP \text{ [dBm]} = -54.0 \text{ [dBm]} + 64.0 \text{ [dB]} - 20.0 \text{ [dBi]} = -10 \text{ [dBm]} \text{ (100 } \mu\text{W)}$$

Note: conversion loss of mixer is already included in analyzer value.

**Equipment table:**

No.	Lab / Item	Equipment	Type	Manufacturer	Serial No.	INV. No.	Kind of Calibration	Last Calibration	Next Calibration
1	n. a.	Double-Ridged Waveguide Horn Antenna 1-18.0GHz	3115	EMCO	8812-3088	300001032	vKI!	02.08.2021	01.08.2023
2	A019	Std. Gain Horn Antenna 17.6-26.7 GHz	638	Narda	156	300000486	vKI!	21.01.2020	20.01.2022
3	A011	Std. Gain Horn Antenna 26.4-40.1 GHz	V637	Narda	82-16	300000510	vKI!	23.01.2020	22.01.2022
4	A023	Std. Gain Horn Antenna 39.3-59.7 GHz	2424-20	Flann	75	300001979	ne	-/-	-/-
5	A035	Std. Gain Horn Antenna 50-75 GHz	COR 50_75	Thomson CSF		300000813	ne	-/-	-/-
6	A037	Std. Gain Horn Antenna 75-110 GHz	COR 75_110	Thomson CSF		300000798	ne	-/-	-/-
7	R001	Signal- and Spectrum Analyzer 3 Hz - 50 GHz	PXA N9030A	Agilent Technologies	US51350267	300004338	k	01.04.2021	31.03.2022
8	R025	Harmonic Mixer 2-Port, 50-80 GHz	M1970V	KEYSIGHT	MY51390914	300005116	k	28.08.2021	27.08.2022
9	R029	Harmonic Mixer 2-Port, 75-110 GHz	M1970W	KEYSIGHT	MY51430848	300005115	k	01.09.2021	31.08.2022
15	R011	Dual-channel power meter with GPIB	438A	HP	2730U00683	300000852	vKI!	08.12.2020	07.12.2022
17	R009	Waveguide Power Sensor, 26.5 to 40 GHz, -30 to +20	R8486A	HP	2503A00340	300000819	vKI!	03.08.2020	02.08.2022
18	Cxxx	Coax cables	div.	H&S	div.	-/-	ev	-/-	-/-
19	n.a.	Temperature Test Chamber	T-40/50	CTS GmbH	064023	300003540	ev	08.05.2020	07.05.2022

## 8 Sequence of testing

### 8.1 Sequence of testing radiated spurious 9 kHz to 30 MHz

#### Setup

- The equipment is set up to simulate normal operation mode as described in the user manual or defined by the manufacturer.
- If the EUT is a tabletop system, it is placed on a table with 0.8 m height.
- If the EUT is a floor standing device, it is placed directly on the turn table.
- Auxiliary equipment and cables are positioned to simulate normal operation conditions as described in ANSI C 63.4.
- The AC power port of the EUT (if available) is connected to a power outlet below the turntable.
- Measurement distance is 3 m (see ANSI C 63.4) – see test details.
- EUT is set into operation.

#### Premeasurement\*

- The turntable rotates from 0° to 315° using 45° steps.
- The antenna height is 1 m.
- At each turntable position the analyzer sweeps with positive-peak detector to find the maximum of all emissions.

#### Final measurement

- Identified emissions during the pre-measurement are maximized by the software by rotating the turntable from 0° to 360°.
- Loop antenna is rotated about its vertical axis for maximum response at each azimuth about the EUT. (For certain applications, the loop antenna plane may also need to be positioned horizontally at the specified distance from the EUT)
- The final measurement is done in the position (turntable and elevation) causing the highest emissions with quasi-peak (as described in ANSI C 63.4).
- Final levels, frequency, measuring time, bandwidth, turntable position, correction factor, margin to the limit and limit will be recorded. A plot with the graph of the premeasurement and the limit is stored.

\*)Note: The sequence will be repeated three times with different EUT orientations.

## 8.2 Sequence of testing radiated spurious 30 MHz to 1 GHz

### Setup

- The equipment is set up to simulate normal operation mode as described in the user manual or defined by the manufacturer.
- If the EUT is a tabletop system, a table with 0.8 m height is used, which is placed on the ground plane.
- If the EUT is a floor standing device, it is placed on the ground plane with insulation between both.
- Auxiliary equipment and cables are positioned to simulate normal operation conditions as described in ANSI C 63.4.
- The AC power port of the EUT (if available) is connected to a power outlet below the turntable.
- Measurement distance is 10 m or 3 m (see ANSI C 63.4) – see test details.
- EUT is set into operation.

### Premeasurement

- The turntable rotates from 0° to 315° using 45° steps.
- The antenna is polarized vertical and horizontal.
- The antenna height changes from 1 m to 3 m.
- At each turntable position, antenna polarization and height the analyzer sweeps three times in peak to find the maximum of all emissions.

### Final measurement

- The final measurement is performed for at least six highest peaks according to the requirements of the ANSI C63.4.
- Based on antenna and turntable positions at which the peak values are measured the software maximize the peaks by changing turntable position  $\pm 45^\circ$  and antenna height between 1 and 4 m.
- The final measurement is done with quasi-peak detector (as described in ANSI C 63.4).
- Final levels, frequency, measuring time, bandwidth, antenna height, antenna polarization, turntable angle, correction factor, margin to the limit and limit are recorded. A plot with the graph of the premeasurement with marked maximum final results and the limit is stored.



### 8.3 Sequence of testing radiated spurious 1 GHz to 18 GHz

#### Setup

- The equipment is set up to simulate normal operation mode as described in the user manual or defined by the manufacturer.
- If the EUT is a tabletop system, a 2-axis positioner with 1.5 m height is used.
- If the EUT is a floor standing device, it is placed directly on the turn table.
- Auxiliary equipment and cables are positioned to simulate normal operation conditions as described in ANSI C 63.4.
- The AC power port of the EUT (if available) is connected to a power outlet below the turntable.
- Measurement distance is 3 m (see ANSI C 63.4) – see test details.
- EUT is set into operation.

#### Premeasurement

- The turntable rotates from 0° to 315° using 45° steps.
- The antenna is polarized vertical and horizontal.
- The antenna height is 1.5 m.
- At each turntable position and antenna polarization the analyzer sweeps with positive peak detector to find the maximum of all emissions.

#### Final measurement

- The final measurement is performed for at least six highest peaks according to the requirements of the ANSI C63.4.
- Based on antenna and turntable positions at which the peak values are measured the software maximizes the peaks by rotating the turntable from 0° to 360°. This measurement is repeated for different EUT-table positions (0° to 150° in 30°-steps) and for both antenna polarizations.
- The final measurement is done in the position (turntable, EUT-table and antenna polarization) causing the highest emissions with Peak and RMS detector (as described in ANSI C 63.4).
- Final levels, frequency, measuring time, bandwidth, turntable position, EUT-table position, antenna polarization, correction factor, margin to the limit and limit are recorded. A plot with the graph of the premeasurement with marked maximum final results and the limit is stored.

## 8.4 Sequence of testing radiated spurious above 18 GHz

### Setup

- The equipment is set up to simulate normal operation mode as described in the user manual or defined by the manufacturer.
- Auxiliary equipment and cables are positioned to simulate normal operation conditions as described in ANSI C 63.4.
- The AC power port of the EUT (if available) is connected to a power outlet.
- The measurement distance is as appropriate (e.g. 0.5 m).
- The EUT is set into operation.

### Premeasurement

- The test antenna is handheld and moved carefully over the EUT to cover the EUT's whole sphere and different polarizations of the antenna.

### Final measurement

- The final measurement is performed at the position and antenna orientation causing the highest emissions with Peak and RMS detector (as described in ANSI C 63.4).
- Final levels, frequency, measuring time, bandwidth, correction factor, margin to the limit and limit are recorded. A plot with the graph of the premeasurement and the limit is stored.

## 8.5 Sequence of testing radiated spurious above 50 GHz with external mixers

### Setup

- The equipment is set up to simulate normal operation mode as described in the user manual or defined by the manufacturer.
- Auxiliary equipment and cables are positioned to simulate normal operation conditions as described in ANSI C 63.4.
- The AC power port of the EUT (if available) is connected to a power outlet.
- The measurement distance is as appropriate for far field (e.g. 0.25 m).
- The EUT is set into operation.

### Premeasurement

- The test antenna with external mixer is handheld and moved carefully over the EUT to cover the EUT's whole sphere and different polarizations of the antenna.
- Caution is taken to reduce the possible overloading of the external mixer.

### Final measurement

- The final measurement is performed at the position and antenna orientation causing the highest emissions with Peak and RMS detector (as described in ANSI C 63.4).
- As external mixers may generate false images care is taken to ensure that any emission measured by the spectrum analyzer does indeed originate in the EUT. Signal identification feature of spectrum analyzer is used to eliminate false mixer images (i.e., it is not the fundamental emission or a harmonic falling precisely at the measured frequency).
- Final levels, frequency, measuring time, bandwidth, correction factor, margin to the limit and limit are recorded. A plot with the graph of the premeasurement and the limit is stored.

## 9 Measurement results

### 9.1 Summary

The present test report:

<input checked="" type="checkbox"/>	<b>No deviations from the technical specifications were ascertained</b>
<input type="checkbox"/>	There were deviations from the technical specifications ascertained
<input type="checkbox"/>	This test report is only a partial test report. The content and verdict of the performed test cases are listed below.

TC identifier	Description	Verdict	Date	Remark
RF-Testing	CFR 47 Part 25 (Ka-Band)	see below	2022-03-09	-/-

Test Specification Clause	Test Case	C	NC	NA	NP	Remark
§2.1046 / §25.204 /	Measurements required: RF power output / Power limits	X				
§2.1046 / §25.218 /	Measurements required: RF power output. Off-axis EIRP density	X				
§2.1049	Measurements required: Occupied bandwidth	X				
§2.1051 / §25.202 /	Measurements required: Spurious emissions at antenna terminals / Emission limitations (conducted emissions)	X				
§2.1053 / §25.202 /	Measurements required: Field strength of spurious radiation / Emission limitations (radiated emissions)	X				
§2.1055 / §25.202 /	Measurements required: Frequency stability / Transmitter frequency tolerances	X				

**Note:** C = compliant; NC = Not compliant; NA = Not applicable; NP = Not performed

## 9.2 RF power output / Power limits

### Description / Limit:

#### §2.1046 Measurements required: RF power output.

#### §25.204 Power limits

(a) In bands shared coequally with terrestrial radio communication services, the equivalent isotropically radiated power transmitted in any direction towards the horizon by an earth station, other than an ESV, operating in frequency bands between 1 and 15 GHz, shall not exceed the following limits except as provided for in paragraph (c) of this section:

+ 40 dBW in any 4 kHz band for  $\theta \leq 0^\circ$

+ 40 + 3 $\theta$  dBW in any 4 kHz band for  $0^\circ < \theta \leq 5^\circ$

where  $\theta$  is the angle of elevation of the horizon viewed from the center of radiation of the antenna of the earth station and measured in degrees as positive above the horizontal plane and negative below it.

(b) In bands shared coequally with terrestrial radiocommunication services, the equivalent isotropically radiated power transmitted in any direction towards the horizon by an earth station operating in frequency bands above 15 GHz shall not exceed the following limits except as provided for in paragraph (c) of this section:

+ 64 dBW in any 1 MHz band for  $\theta \leq 0^\circ$

+ 64 + 3  $\theta$  dBW in any 1 MHz band for  $0^\circ < \theta \leq 5^\circ$

where  $\theta$  is as defined in paragraph (a) of this section.

(c) For angles of elevation of the horizon greater than  $5^\circ$  there shall be no restriction as to the equivalent isotropically radiated power transmitted by an earth station towards the horizon.

state	freq. (range)	reading level	data of correction attenuation / loss			result			remark
			far field	horn	att. )*	EIRP			
	GHz	dBm	dB	dBi	dB	dBm	dBW	W	
mod	13.755	-5.3	68.5	11.5	0	51.7	21.7	147.9	--
mod	14.125	-6.8	68.4	11.2	0	50.2	20.2	104.7	
mod	14.495	-6.7	68.4	11.4	0	50.3	20.3	107.2	

cw = continuous wave mod = modulated

)\* attenuation and additional correction

### Test setup(s):

Test setup 7.2

### Plots:

see also Annex G, chap. 2, plots 1 - 6

### 9.3 EIRP Spectral Density

**Description / Limit:**

**§2.1046 Measurements required: RF power output.**

**§25.218 Off-axis EIRP density envelopes for FSS earth stations transmitting in certain frequency bands.**

(a) This section applies to applications for fixed and temporary-fixed FSS earth stations transmitting to geostationary space stations in the conventional C-band, extended C-band, conventional Ku-band, extended Ku-band, conventional Ka-band, or 24.75-25.25 GHz and applications for ESIMs transmitting in the conventional C-band, conventional Ku-band, or conventional Ka-band, except for applications proposing transmission of analog command signals at a band edge with bandwidths greater than 1 MHz or transmission of any other type of analog signal with bandwidths greater than 200 kHz.

(i) Digital earth station operation in the conventional Ka-band. (1) For co-polarized transmissions in the plane tangent to the GSO arc:

15-25log( $\theta$ )	dBW/4kHz	for $1.5^\circ \leq \theta \leq 7^\circ$ .
-6	dBW/4kHz	for $7^\circ \leq \theta \leq 9.2^\circ$
18-25log( $\theta$ )	dBW/4kHz	for $9.2^\circ \leq \theta \leq 19.1^\circ$
-14	dBW/4kHz	for $19.1^\circ < \theta \leq 180^\circ$

Where:

$\theta$  is as defined in paragraph (c)(1) of this section.

(2) For co-polarized transmissions in the plane perpendicular to the GSO arc:

18-25log( $\theta$ )	dBW/4kHz	for $3^\circ \leq \theta \leq 19^\circ$
-14	dBW/4kHz	for $19.1^\circ < \theta \leq 180^\circ$

Where  $\theta$  is as defined in paragraph (c)(1) of this section.

(4) For cross-polarized transmissions in the plane tangent to the GSO arc and in the plane perpendicular to the GSO arc:

5-25log( $\theta$ )	dBW/4kHz	for $1.5^\circ < \theta \leq 7.0^\circ$
---------------------	----------	---

Where  $\theta$  is as defined in paragraph (c)(1) of this section.

(c) (1) Where  $\theta$  is the angle in degrees from a line from the earth station antenna to the assigned orbital location of the target satellite.

**§25.204 Power limits for earth stations.**

(e) To the extent specified in paragraphs (e)(1) through (e)(3) of this section, earth stations in the Fixed-Satellite Service may employ uplink adaptive power control or other methods of fade compensation to facilitate transmission of uplinks at power levels required for desired link performance while minimizing interference between networks.

**Test setup:** 7.2

**Plots:**

see Annex G, chap. 2, plots 5 - 9

## 9.4 Occupied bandwidth

### Description / Limit:

#### §2.1049 Measurements required: Occupied bandwidth

The occupied bandwidth, that is the frequency bandwidth such that, below its lower and above its upper frequency limits, the mean powers radiated are each equal to 0.5 percent of the total mean power radiated by a given emission shall be measured under the following conditions as applicable:

(h) Transmitters employing digital modulation techniques—when modulated by an input signal such that its amplitude and symbol rate represent the maximum rated conditions under which the equipment will be operated. The signal shall be applied through any filter networks, pseudo-random generators or other devices required in normal service.

Operating condition	Frequency	Modulation	Data rate / Symbol rate	Occupied bandwidth [MHz]	Annex G / Plot
1	fl, fm, fh	BPSK	2.24 MSym/s	0.87	chap. 2 – 2, 4, 6

### Test setup(s):

Test setup 7.2

### Plots:

see also Annex G, chap. 2, plots 2 - 6

## 9.5 Emissions limitations (conducted emissions)

### Description / Limit:

**§2.1051 Measurements required: Spurious emissions at antenna terminals.**

**§25.202 Frequencies, frequency tolerance and emission limitations**

(f) *Emission limitations.* Except for SDARS terrestrial repeaters and as provided for in paragraph (i), the mean power of emissions shall be attenuated below the mean output power of the transmitter in accordance with the schedule set forth in paragraphs (f)(1) through (f)(4) of this section. The out-of-band emissions of SDARS terrestrial repeaters shall be attenuated in accordance with the schedule set forth in paragraph (h) of this section.

(1) In any 4 kHz band, the center frequency of which is removed from the assigned frequency by more than 50 percent up to and including 100 percent of the authorized bandwidth: 25 dB;

(2) In any 4 kHz band, the center frequency of which is removed from the assigned frequency by more than 100 percent up to and including 250 percent of the authorized bandwidth: 35 dB;

(3) In any 4 kHz band, the center frequency of which is removed from the assigned frequency by more than 250 percent of the authorized bandwidth: An amount equal to 43 dB plus 10 times the logarithm (to the base 10) of the transmitter power in watts;

(4) In any event, when an emission outside of the authorized bandwidth causes harmful interference, the Commission may, at its discretion, require greater attenuation than specified in paragraphs (f) (1), (2) and (3) of this section.

### Measurement results:

Conducted Spurious Emissions [ dBm ]								
fl			fm			fh		
F [ GHz ]	Detector	Level [ dBm ]	F [ GHz ]	Detector	Level [ dBm ]	F [ GHz ]	Detector	Level [ dBm ]
No critical peaks detected.			No critical peaks detected.			No critical peaks detected.		
Measurement uncertainty			± 2 dB					

**Test setup:** 7.2, 7.3

### Plots:

-/-

### Note:

This measurement was performed with the radiated set-up because the antenna is fully integrated and can't be separated (see 9.6).



## 9.6 Emissions limits (radiated emissions)

### Description / Limit:

**§2.1053 Measurements required: Field strength of spurious radiation.**

**§25.202 Frequencies, frequency tolerance and emission limitations**

(f) *Emission limitations.* Except for SDARS terrestrial repeaters and as provided for in paragraph (i), the mean power of emissions shall be attenuated below the mean output power of the transmitter in accordance with the schedule set forth in paragraphs (f)(1) through (f)(4) of this section. The out-of-band emissions of SDARS terrestrial repeaters shall be attenuated in accordance with the schedule set forth in paragraph (h) of this section.

(1) In any 4 kHz band, the center frequency of which is removed from the assigned frequency by more than 50 percent up to and including 100 percent of the authorized bandwidth: 25 dB;

(2) In any 4 kHz band, the center frequency of which is removed from the assigned frequency by more than 100 percent up to and including 250 percent of the authorized bandwidth: 35 dB;

(3) In any 4 kHz band, the center frequency of which is removed from the assigned frequency by more than 250 percent of the authorized bandwidth: An amount equal to 43 dB plus 10 times the logarithm (to the base 10) of the transmitter power in watts;

(4) In any event, when an emission outside of the authorized bandwidth causes harmful interference, the Commission may, at its discretion, require greater attenuation than specified in paragraphs (f) (1), (2) and (3) of this section.

### Measurement results:

Radiated Spurious Emissions [ dBm ]								
fl			fm			fh		
F [ GHz ]	Detector	Level [ dBm ]	F [ GHz ]	Detector	Level [ dBm ]	F [ GHz ]	Detector	Level [ dBm ]
No critical peaks detected.			No critical peaks detected.			No critical peaks detected.		
Measurement uncertainty			± 3 dB					

**Test setup:** 7.1 – 7.3

### Plots:

see Annex G, chap. 2, plots 7 - 36  
and Annex G, chap. 3, plots 1, 2, 3

## 9.7 Transmitter frequency tolerance

### Description / Limit:

**§2.1055 Measurements required: Frequency stability.**

**§25.202 Frequencies, frequency tolerance and emission limitations**

(d) *Frequency tolerance, Earth stations.* The carrier frequency of each earth station transmitter authorized in these services shall be maintained within 0.001 percent of the reference frequency.

Temperature [ °C ]	Voltage [ V AC ]	Reference Frequency [ GHz ]	Measured Frequency [ GHz ]	Deviation [ kHz ]	Deviation [ ppm ]
-20	V nom	13.755000000	13.7549984871	-1.513	-0.11
-10	V nom	13.755000000	13.7549985109	-1.489	-0.11
0	V nom	13.755000000	13.7549992378	-0.762	-0.06
10	V nom	13.755000000	13.7549991395	-0.861	-0.06
20	V min	13.755000000	13.7549991178	-0.882	-0.06
20	V nom	13.755000000	13.7549991098	-0.890	-0.06
20	V max	13.755000000	13.7549991139	-0.886	-0.06
30	V nom	13.755000000	13.7549990337	-0.966	-0.07
40	V nom	13.755000000	13.7549991276	-0.872	-0.06
50	V nom	13.755000000	13.7549991763	-0.824	-0.06
55	V nom	13.755000000	13.7549991956	-0.804	-0.06

Temperature [ °C ]	Voltage [ V AC ]	Reference Frequency [ GHz ]	Measured Frequency [ GHz ]	Deviation [ kHz ]	Deviation [ ppm ]
-20	V nom	14.125000000	14.124998500800	-1.499	-0.11
-10	V nom	14.125000000	14.124998584900	-1.415	-0.10
0	V nom	14.125000000	14.124999337800	-0.662	-0.05
10	V nom	14.125000000	14.124999142300	-0.858	-0.06
20	V min	14.125000000	14.124999125300	-0.875	-0.06
20	V nom	14.125000000	14.124999118600	-0.881	-0.06
20	V max	14.125000000	14.124999123800	-0.876	-0.06
30	V nom	14.125000000	14.124999055400	-0.945	-0.07
40	V nom	14.125000000	14.124999121700	-0.878	-0.06
50	V nom	14.125000000	14.124999186800	-0.813	-0.06
55	V nom	14.125000000	14.124999211900	-0.788	-0.06

Temperature [ °C ]	Voltage [ V AC ]	Reference Frequency [ GHz ]	Measured Frequency [ GHz ]	Deviation [ kHz ]	Deviation [ ppm ]
-20	V nom	14.495000000	14.4949985112	-1.489	-0.10
-10	V nom	14.495000000	14.4949985649	-1.435	-0.10
0	V nom	14.495000000	14.4949993711	-0.629	-0.04
10	V nom	14.495000000	14.4949991223	-0.878	-0.06
20	V min	14.495000000	14.4949991151	-0.885	-0.06
20	V nom	14.495000000	14.4949991108	-0.889	-0.06
20	V max	14.495000000	14.4949991131	-0.887	-0.06
30	V nom	14.495000000	14.4949990156	-0.984	-0.07
40	V nom	14.495000000	14.4949991162	-0.884	-0.06
50	V nom	14.495000000	14.4949991827	-0.817	-0.06
55	V nom	14.495000000	14.4949992207	-0.779	-0.05

**Test setup:** 7.2 + climatic chamber

**Note:**

For performing the frequency stability test the whole system was placed in the climatic chamber and forced to transmit an unmodulated carrier (CW).

## 10 Glossary

<b>EUT</b>	Equipment under test
<b>DUT</b>	Device under test
<b>UUT</b>	Unit under test
<b>GUE</b>	GNSS User Equipment
<b>ETSI</b>	European Telecommunications Standards Institute
<b>EN</b>	European Standard
<b>FCC</b>	Federal Communications Commission
<b>FCC ID</b>	Company Identifier at FCC
<b>IC</b>	Industry Canada
<b>PMN</b>	Product marketing name
<b>HMN</b>	Host marketing name
<b>HVIN</b>	Hardware version identification number
<b>FVIN</b>	Firmware version identification number
<b>EMC</b>	Electromagnetic Compatibility
<b>HW</b>	Hardware
<b>SW</b>	Software
<b>Inv. No.</b>	Inventory number
<b>S/N or SN</b>	Serial number
<b>C</b>	Compliant
<b>NC</b>	Not compliant
<b>NA</b>	Not applicable
<b>NP</b>	Not performed
<b>PP</b>	Positive peak
<b>QP</b>	Quasi peak
<b>AVG</b>	Average
<b>OC</b>	Operating channel
<b>OCW</b>	Operating channel bandwidth
<b>OBW</b>	Occupied bandwidth
<b>OOB</b>	Out of band
<b>DFS</b>	Dynamic frequency selection
<b>CAC</b>	Channel availability check
<b>OP</b>	Occupancy period
<b>NOP</b>	Non occupancy period
<b>DC</b>	Duty cycle
<b>PER</b>	Packet error rate
<b>CW</b>	Clean wave
<b>MC</b>	Modulated carrier
<b>WLAN</b>	Wireless local area network
<b>RLAN</b>	Radio local area network
<b>DSSS</b>	Dynamic sequence spread spectrum
<b>OFDM</b>	Orthogonal frequency division multiplexing
<b>FHSS</b>	Frequency hopping spread spectrum
<b>GNSS</b>	Global Navigation Satellite System
<b>C/N<sub>0</sub></b>	Carrier to noise-density ratio, expressed in dB-Hz

**11 Document history**

Version	Applied changes	Date of release
-/-	Initial release - DRAFT	2021-10-22

**12 Accreditation Certificate – D-PL-12076-01-05**

first page	last page
 <p>DAkkS Deutsche Akkreditierungsstelle</p> <p>Deutsche Akkreditierungsstelle GmbH</p> <p>Entrusted according to Section 8 subsection 1 AkkStelleG in connection with Section 1 subsection 1 AkkStelleGBV Signatory to the Multilateral Agreements of EA, ILAC and IAF for Mutual Recognition</p> <p><b>Accreditation</b></p> <p>The Deutsche Akkreditierungsstelle GmbH attests that the testing laboratory <b>CTC advanced GmbH</b> Untertürkheimer Straße 6-10, 66117 Saarbrücken is competent under the terms of DIN EN ISO/IEC 17025:2018 to carry out tests in the following fields: <b>Telecommunication (FCC Requirements)</b></p> <p>The accreditation certificate shall only apply in connection with the notice of accreditation of 09.06.2020 with the accreditation number D-PL-12076-01. It comprises the cover sheet, the reverse side of the cover sheet and the following annex with a total of 05 pages.</p> <p>Registration number of the certificate: <b>D-PL-12076-01-05</b></p> <p>Frankfurt am Main, 09.06.2020</p> <p>by <i>Dr. Dipl.-Ing. (FH) Ralf Egnier</i> Head of Division</p> <p>The certificate together with its annex reflects the status at the time of the date of issue. The current status of the scope of accreditation can be found in the database of accredited bodies of Deutsche Akkreditierungsstelle GmbH. <a href="https://www.dakks.de/en/content/accredited-bodies-dakks">https://www.dakks.de/en/content/accredited-bodies-dakks</a> See notes essential.</p>	 <p>Deutsche Akkreditierungsstelle GmbH</p> <p>Office Berlin Spittelmarkt 10 10117 Berlin</p> <p>Office Frankfurt am Main Europa-Allee 52 60327 Frankfurt am Main</p> <p>Office Braunschweig Bundesallee 100 38116 Braunschweig</p> <p>The publication of extracts of the accreditation certificate is subject to the prior written approval by Deutsche Akkreditierungsstelle GmbH (DAkkS). Exempted is the unchanged form of separate disseminations of the cover sheet by the conformity assessment body mentioned overleaf.</p> <p>No impression shall be made that the accreditation also extends to fields beyond the scope of accreditation attested by DAkkS.</p> <p>The accreditation was granted pursuant to the Act on the Accreditation Body (AkkStelleG) of 31 July 2009 (Federal Law Gazette I p. 2625) and the Regulation (EC) No 765/2008 of the European Parliament and of the Council of 9 July 2008 setting out the requirements for accreditation and market surveillance relating to the marketing of products (Official Journal of the European Union L 218 of 9 July 2008, p. 30). DAkkS is a signatory to the Multilateral Agreements for Mutual Recognition of the European co-operation for Accreditation (EA), International Accreditation Forum (IAF) and International Laboratory Accreditation Cooperation (ILAC). The signatories to these agreements recognise each other's accreditations.</p> <p>The up-to-date state of membership can be retrieved from the following websites: EA: <a href="http://www.european-accreditation.org">www.european-accreditation.org</a> ILAC: <a href="http://www.ilac.org">www.ilac.org</a> IAF: <a href="http://www.iaf.nu">www.iaf.nu</a></p>

**Note: The current certificate annex is published on the websites (link see below).**

<https://www.dakks.de/files/data/as/pdf/D-PL-12076-01-05.pdf>

or

[https://ctcadvanced.com/app/uploads/2020/06/D-PL-12076-01-05\\_TCB\\_USA.pdf](https://ctcadvanced.com/app/uploads/2020/06/D-PL-12076-01-05_TCB_USA.pdf)

##### END OF TEST REPORT #####