

Yaber

型号:V12投影仪

Type:快速指引(合订)

材质:铜版纸105g, 封面封底157g过哑油

尺寸:130*160mm

设计师:Samuel

颜色:单色印刷

工艺:钉装, 正反面印刷

日期:2023/12/28

变更备注:1. 修改社媒信息&文案——23/12.28

Yaber

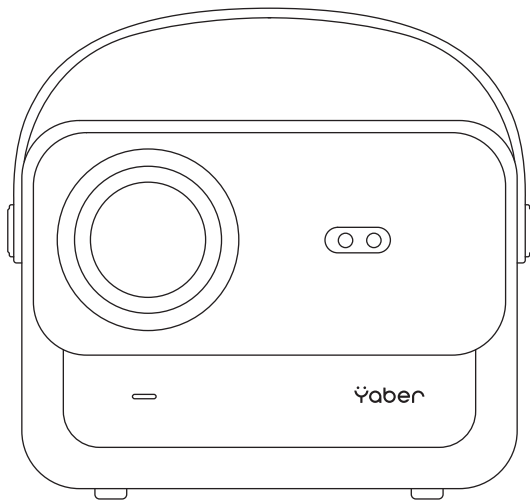

Quick Start Guide

V12 PROJECTOR **EN**

Package Contents

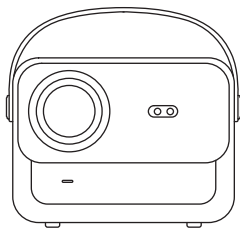

V12 Projector

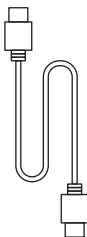

HDMI Cable

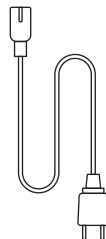

Power Cord



Remote Control

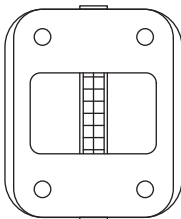

Projector Base

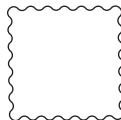

Cleaning Cloth

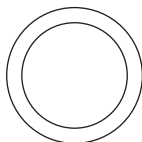

Lens Cover



Quick Start Guide

Product Overview

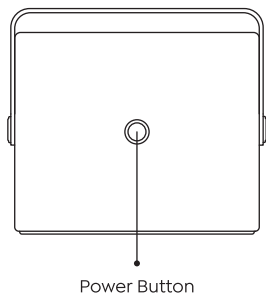
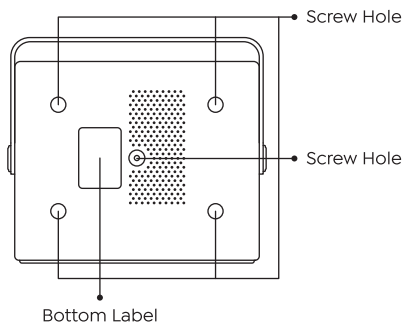
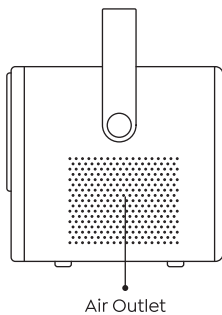
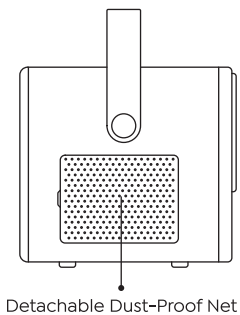
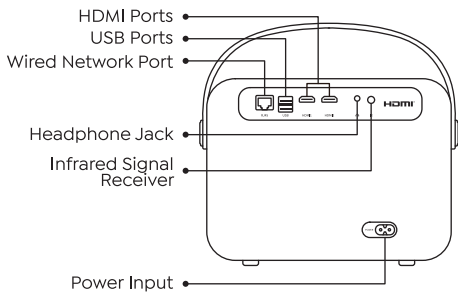
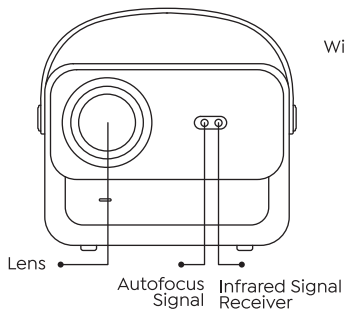

Remote Control

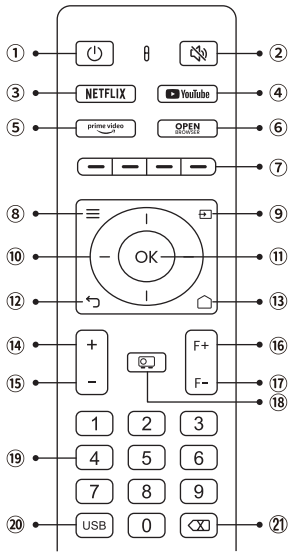

1. Power
2. Mute
3. NETFLIX
4. YouTube
5. Prime Video
6. Open BROWSER
7. Red/Green/Yellow/Blue keys
8. Menu
9. Source
10. Arrow keys
11. Confirmation key
12. Back
13. Homepage
14. Volume+
15. Volume-
16. Focus+
17. Focus-
18. Projection mode
19. Number
20. USB
21. Backspace

Base Installation

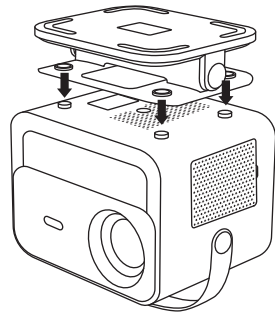
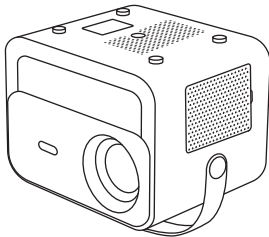

1. Turn the machine over, back side up.

2. Match the holes of the base to the screw holes on the projector.

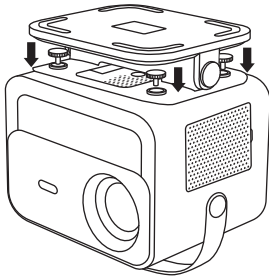

3. Tighten the screws in the accessory box.

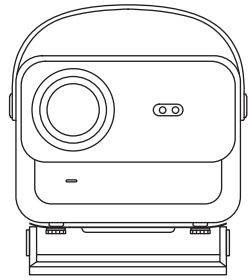

4. Complete the installation.

Turn on Yaber Projector

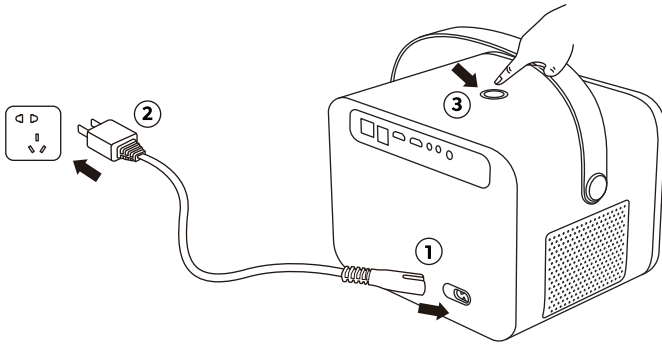

Adjust the Angle and Definition

Image Adjustment

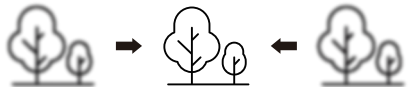
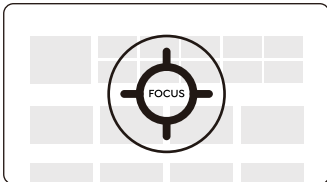

If the image is not clear. You can use the electric focus function, and press the focus buttons "F+" and "F-" on the remote control to adjust the focus of the lens, until the image is clear.

Note: If it is still blurry, please try moving projector to the best distance. The best projection distance is 2-3 meters.

Connect Devices

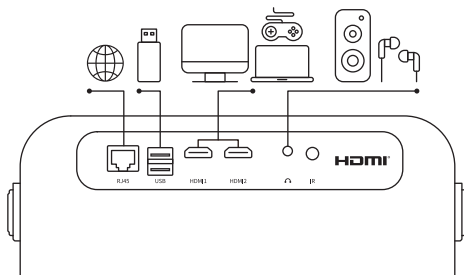

Yaber V12 projector has 6 ports, Wired Network Port, USB port*2 / HDMI port*2 / Headphone Port. Please select the correct connecting port to connect your device (PC, Phone, DVD Player, Sound bar, USB, PS4 etc.)

1.For other Devices

If you are using other system devices, please scan the QR at the end of this QSG to get more information for screen mirroring. Or please feel free to contact us at service@yaber.com

2.Miracast (for Android Devices)

To activate this function, your android device must support Multi-Screen/Wireless Display. The name of "Multi-Screen" may vary depending on various brands of Android devices.

Step 1: Connect your Phone to WiFi

Step 2: Turn on the projector, and open "ScreenCast" APP on the projector

Step 3: Turn on the "Multi-Screen/Wireless Display" of your Android device.

Step 4: Select "Yaber-V12 Projector/Smart Projector" from the search results to connect.

Step 5: Succeed.

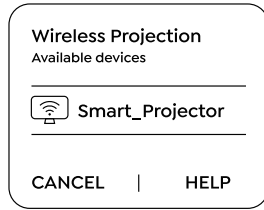
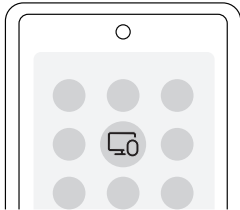
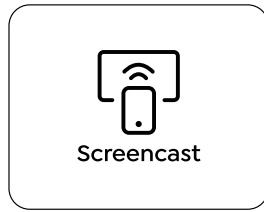
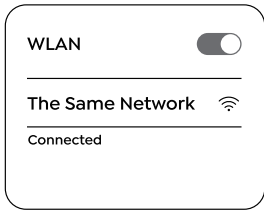

3.Connect the Devices via the HDMI port

1. Connect your TV stick or laptop to any HDMI port of the projector.

2.Enter the home page to select the corresponding HDMI as the signal source.

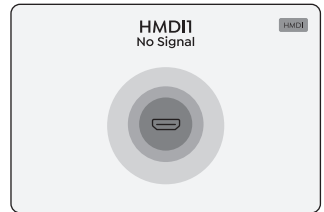

Bluetooth Settings

1. Open your Bluetooth device.

2. Go to home page - Select the [⌘] menu - Select the [Bluetooth Setting] menu - Open the Bluetooth function - Select your Bluetooth device - Press the OK button to connect.

Note:

The V12 projector is compatible with the Bluetooth headsets, Bluetooth speakers and AirPods, but not the Bluetooth keyboards or Bluetooth phones.



Scan and download the PDF user manual

Where to Get More Help

✉ service@yaber.com ✉ aftersales@yaber.com 🌐 www.yaber.com

▶ [@yaberofficial](https://www.youtube.com/@yaberofficial)  [Yaber](https://www.facebook.com/Yaber)  [yaberprojector.us](https://discord.com/invite/yaberprojector.us)

Yaber

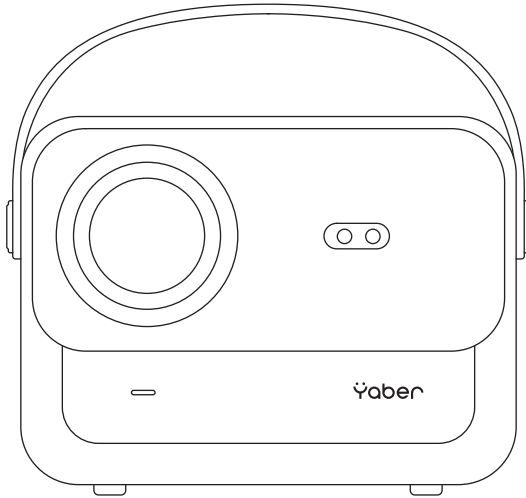

Gebrauchsanweisung

V12 PROJEKTOR **DE**

Lieferumfang

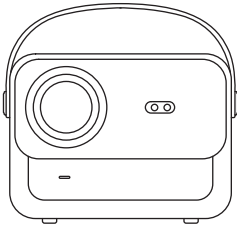

V12 Projektor

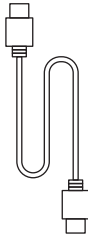

HDMI Kable

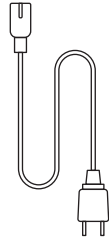

Netzanschl



Fernbedienung

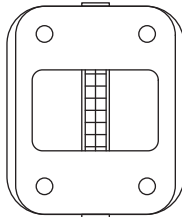

Halterung Abnehmbares

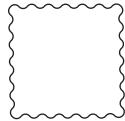

Reinigungs kits

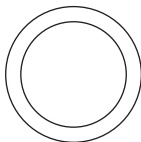

Objektivabdeckung



Schnellstartanleitung

Projektor-Übersicht

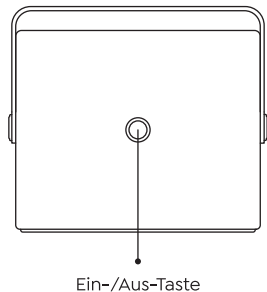
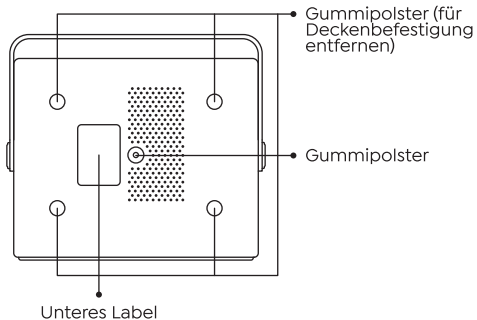
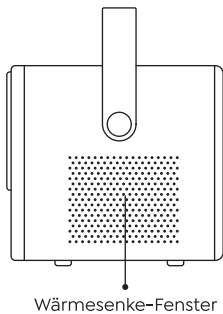
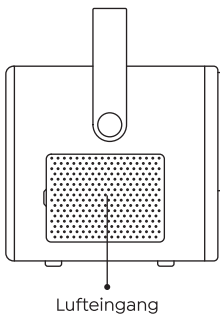
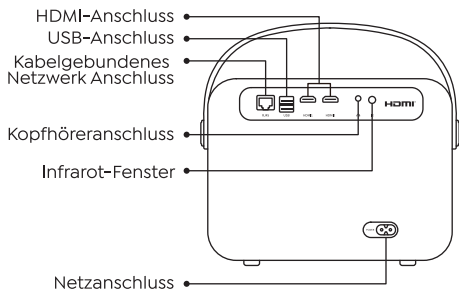
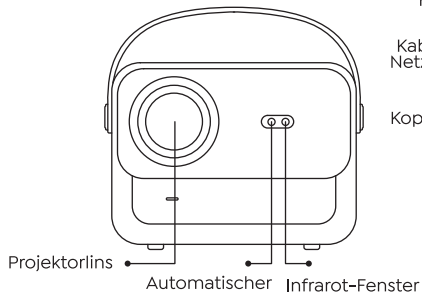

Fernbedienung

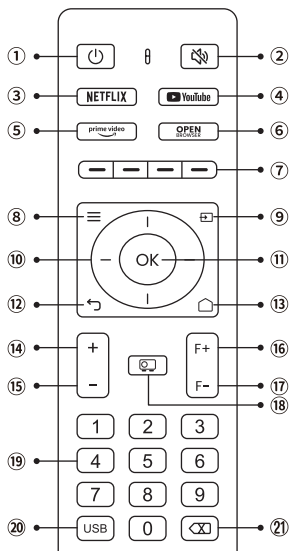

1. Bereitschaft ein/aus
2. Stumm
3. NETFLIX
4. YouTube
5. Prime Video
6. Öffnen Sie BROWSER
7. Rote/Grüne/Gelbe/Blau Tasten
8. Menü
9. Quelle
10. Pfeiltasten
11. OK
12. Zurück/Beenden
13. Hauptseite
14. Lautstärke+
15. Lautstärke-
16. Fokus+
17. Fokus-
18. Projektions-Modus
19. Zahlwort
20. USB
21. Rücktaste

Installation

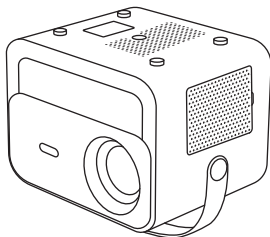

1. Drehen Sie der projektor mit dem Rücken nach oben um.

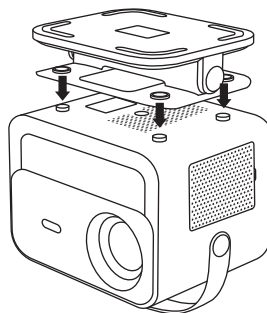

2. Passen Sie die Löcher des Sockels an die Schraube an Löcher am Projektor.

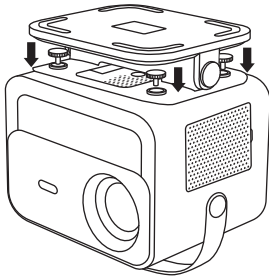

3. Ziehen Sie die Schrauben in der Zubehörbox fest.

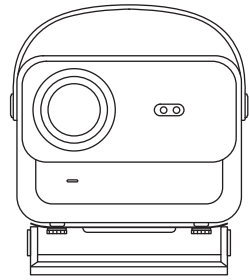

4. Schließen Sie die Installation ab.

Schalten Sie den Yaber-Projektor ein

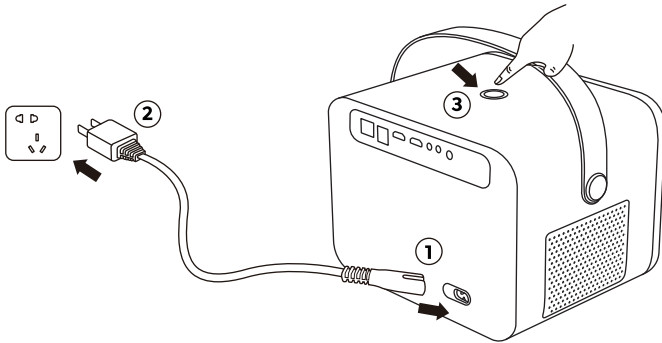

Anpassen des Winkels und der Definition

Bildanpassungen

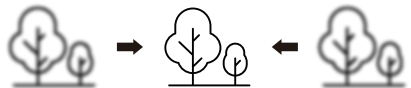
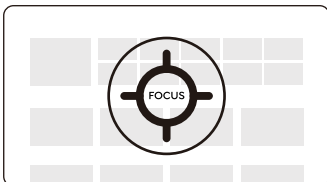

Wenn das Bild nicht klar ist. Sie können die elektrische Fokusfunktion verwenden und die Fokustasten "F+" und "F-" auf der Fernbedienung drücken, um den Fokus des Objektivs einzustellen, bis das Bild klar ist.

Hinweis: Wenn es immer noch verschwommen ist, versuchen Sie bitte, den Projektor in den besten Abstand zu bringen. Der beste Projektionsabstand beträgt 2-3 Meter.

Geräte Verbinden

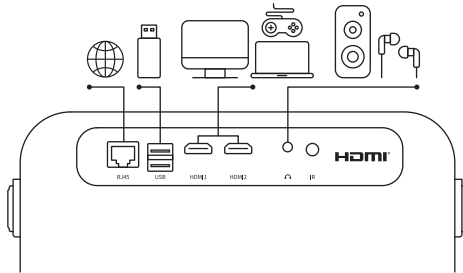

Der Yaber V12-Projektor verfügt über 6 Anschlüsse, einen kabelgebundenen Netzwerkanschluss, einen USB-Anschluss * 2 / einen HDMI-Anschluss * 2 / Kopfhöreranschluss. Bitte wählen Sie den richtigen Anschluss, um Ihr Gerät anzuschließen (PC, Telefon, DVD-Player, Soundbar, USB Stick, PS4 usw.)

1. Für andere Gerätes

Wenn Sie andere Systemgeräte verwenden, scannen Sie bitte den QR am Ende dieser gebrauchsanweisung, um weitere Informationen zur Bildschirm Spiegelung zu erhalten. Oder kontaktieren Sie uns gerne unter service@yaber.com

2. Miracast (für Android-Geräte)

Um diese Funktion zu aktivieren, muss Ihr Android-Gerät Multi-Screen/Wireless unterstützen. Zeigen. Der Name von "Multi-Screen" kann je nach Marke von Android-Geräten variieren.

Schritt 1: Verbinden Sie Ihr Telefon mit dem WLAN;

Schritt 2: Schalten Sie den Projektor ein und öffnen Sie die "ScreenCast"-APP auf dem Projektor;

Schritt 3: Schalten Sie das "Multi-Screen/Wireless Display" Ihres Android-Geräts ein;

Schritt 4: Wählen Sie "Yaber-V12 Projektor/Smart Projektor" aus den Suchergebnissen aus;

Schritt 5: Erfolgreich.

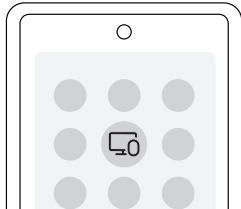
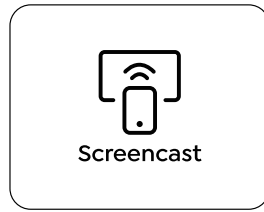
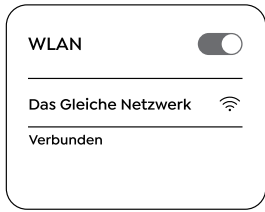

3. Schließen Sie die Geräte über den HDMI-Anschluss an

1. Schließen Sie Ihren TV-Stick oder Laptop an einen HDMI-Anschluss des Projektors an.
2. Rufen Sie die Startseite auf, um den entsprechenden HDMI-Anschluss als Signalquelle auszuwählen.

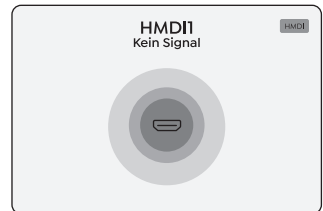

Bluetooth-Einstellungen

1. Öffnen Sie Ihr Bluetooth-Gerät.
2. Gehen Sie zur Startseite - Wählen Sie das [Menü] - Wählen Sie das Menü [Bluetooth-Einstellung] - Öffnen Sie die Bluetooth-Funktion - Wählen Sie Ihr Bluetooth-Gerät aus - Drücken Sie die Taste OK, um eine Verbindung herzustellen.

Tipps:

Der Yaber V12-Projektor ist mit Bluetooth-Headsets, Bluetooth-Lautsprechern und AirPods kompatibel, jedoch nicht mit Bluetooth-Tastaturen oder Bluetooth-Telefonen.



Scannen Sie das PDF-Benutzerhandbuch und laden Sie es herunter

Wo bekomme ich weitere Hilfe?

✉ service@yaber.com ✉ aftersales@yaber.com 🌐 www.yaber.com

▶ [@yaberofficial](https://www.youtube.com/@yaberofficial)  [Yaber](https://www.facebook.com/Yaber)  [yaberprojector.us](https://discord.com/invite/yaberprojector.us)

Yaber

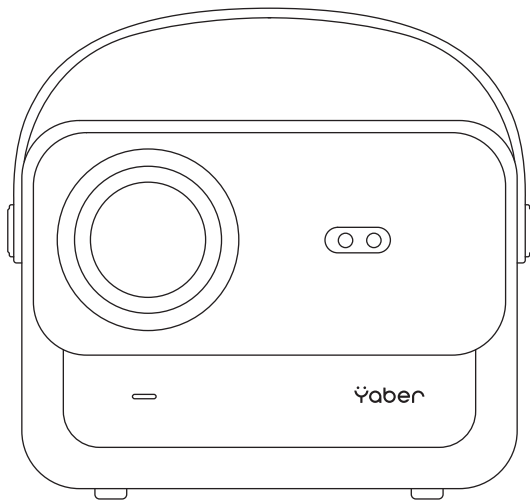

Guide de démarrage rapide

PROJECTEUR V12 **FR**

Contenu du colis

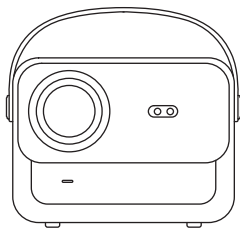

Projecteur V12

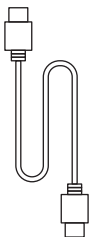

Câble HDMI

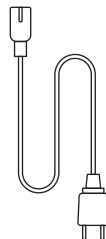

Cordon d'alimentation



Télécommande

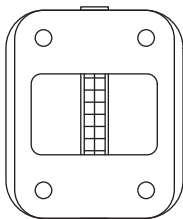

Socle du projecteur

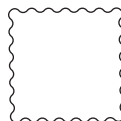

Chiffon de nettoyage

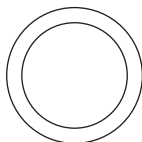

Cache-objectif



Guide de démarrage rapide

Présentation du produit

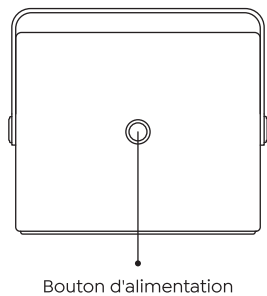
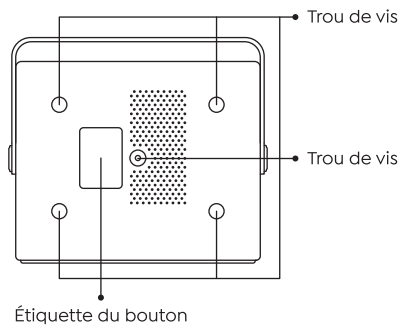
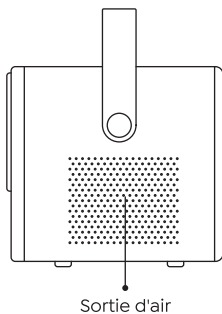
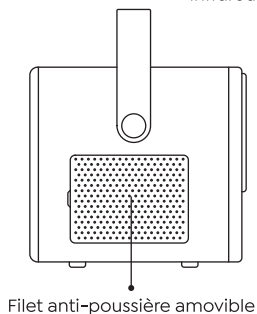
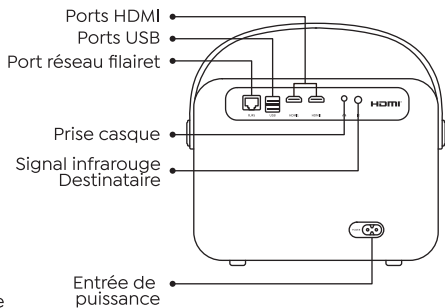
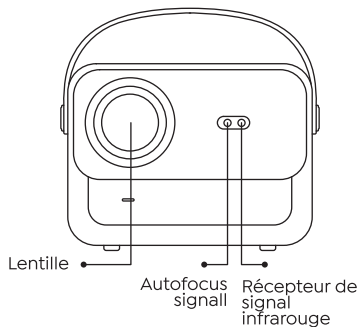

Télécommande

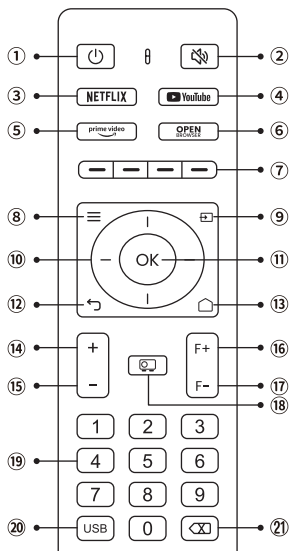

1. Puissance
2. Muet
3. NETFLIX
4. YouTube
5. Amazon Prime Vidéo
6. Ouvrez le navigateur
7. Touches rouge / Vert / Jaune / Bleu
8. Menu
9. Source
10. Touches fléchées
11. Touche de confirmation
12. Retour
13. Papier d'accueil
14. Volume+
15. Volume-
16. Concentration+
17. Concentration-
18. Mode de projection
19. Numéro
20. USB
21. Retour arrière

Installation du socle

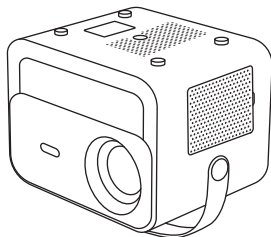

1. Retournez la machine, face arrière vers le haut.

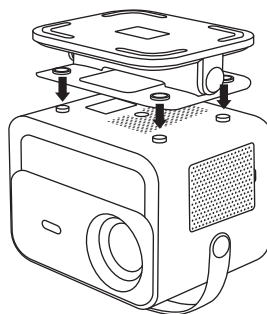

2. Faites correspondre les trous de la base avec les trous de vis du projecteur.

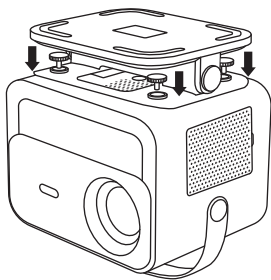

3. Serrez les vis dans la boîte d'accessoires.

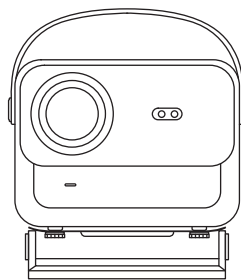

4. Terminez l'installation.

Allumez le Projecteur Yaber

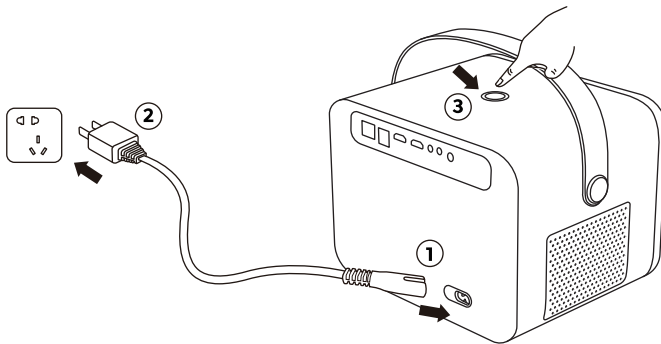

Ajuster l'angle et la définition

Ajustement de l'image

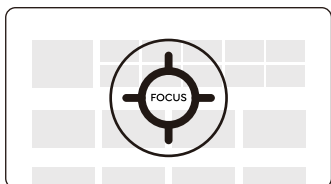

Si l'image n'est pas claire. Vous pouvez utiliser la fonction de mise au point électrique et appuyer sur les boutons de mise au point "F+" et "F-" de la télécommande pour régler la mise au point de l'objectif, jusqu'à ce que l'image soit claire.

Remarque: Si l'image reste floue, essayez de déplacer le projecteur à la meilleure distance. Le meilleur la distance de projection est de 2 à 3 mètres.

Connecter des appareils

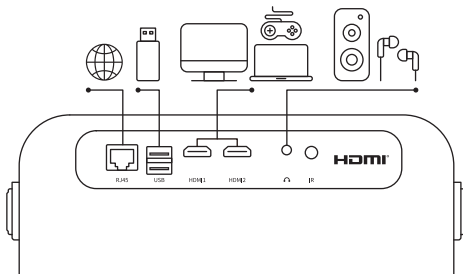

Le projecteur Yaber V12 dispose de 6 ports, d'un port réseau filaire, d'un port USB*2 / d'un port HDMI*2/Port casque. Veuillez sélectionner le bon port de connexion pour connecter votre appareil (PC, téléphone, lecteur DVD, barre de son, USB, PS4, etc.)

1. Pour les autres appareils

Si vous utilisez d'autres appareils système, veuillez scanner le QR à la fin de ce QSG pour obtenir plus d'informations sur la mise en miroir d'écran. Ou n'hésitez pas à nous contacter à service@yaber.com

2. Miracast (pour les appareils Android)

Pour activer cette fonction, votre appareil Android doit prendre en charge le multi-écran / sans fil Afficher. Le nom "Multi-écran" peut varier en fonction des différentes marques d'appareils Android.

Étape 1 : Connectez votre téléphone au WiFi

Étape 2 : Allumez le projecteur et ouvrez l'application " Screencast " sur le projecteur

Étape 3 : Activez " Affichage multi-écran/sans fil " de votre appareil Android.

Étape 4 : Sélectionnez " Projecteur Yaber-V12/Projecteur intelligent " dans les résultats de la recherche pour vous connecter.

Étape 5 : Réussir.

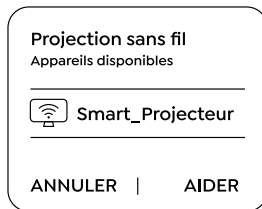
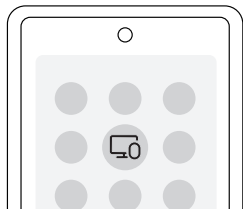
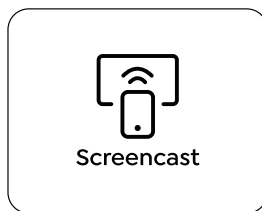

3. Connectez les appareils via le port HDMI

1. Connectez votre clé TV ou votre ordinateur portable à n'importe quel port HDMI du projecteur.
2. Accédez à la page d'accueil pour sélectionner le HDMI correspondant comme source de signal.

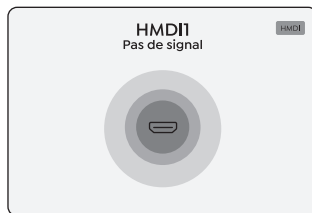

Paramètres Bluetooth

1. Ouvrez votre appareil Bluetooth.
2. Accédez à la page d'accueil - Sélectionnez le [🔗] - Sélectionnez le menu [Paramètres Bluetooth] - Ouvrez la fonction Bluetooth - Sélectionnez votre appareil Bluetooth - Appuyez sur le bouton OK pour vous connecter.

Note:

Le projecteur V12 est compatible avec les casques Bluetooth, les enceintes Bluetooth et les AirPods, mais pas les claviers Bluetooth ni les téléphones Bluetooth.



Scannez et téléchargez le manuel d'utilisation au format PDF

Où obtenir plus d'aide

✉ service@yaber.com ✉ aftersales@yaber.com 🌐 www.yaber.com

▶ [@yaberofficial](https://www.youtube.com/@yaberofficial)  [Yaber](https://www.facebook.com/Yaber)  [yaberprojector.us](https://www.soundcloud.com/yaberprojector.us)

Yaber

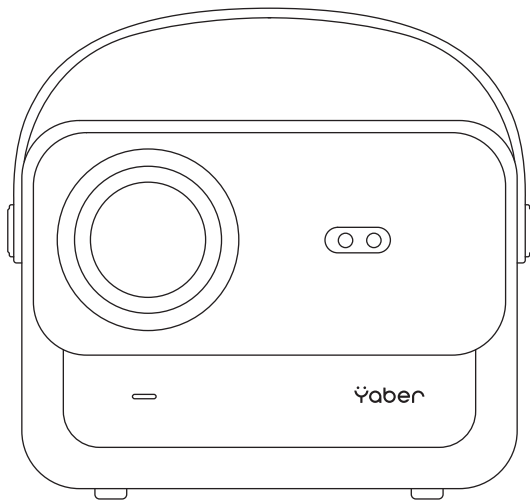

Guida Rapida

PROIETTORE V12 **IT**

Contenuto del Pacco

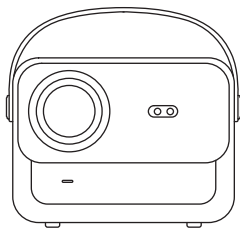

Proiettore V12

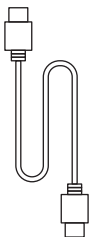

Cavo HDMI

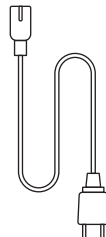

Cavo di Alimentazione



Telecomando

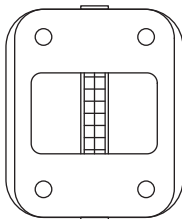

Base el Proiettore

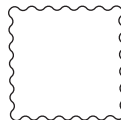

Pezza per Pulire

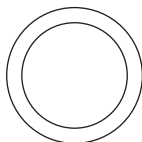

Copriobiettivo



Guida Rapida

Panoramica del Prodotto

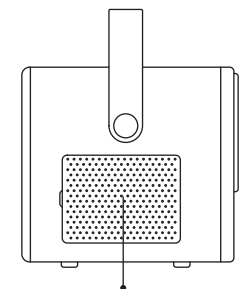
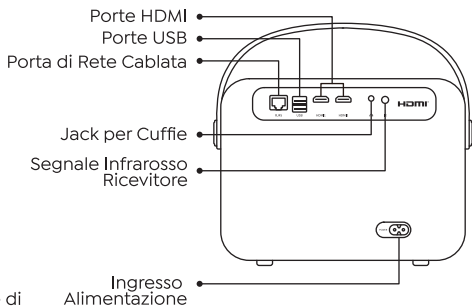
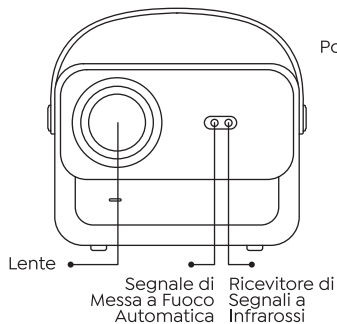

Rete Staccabile Antipolvere

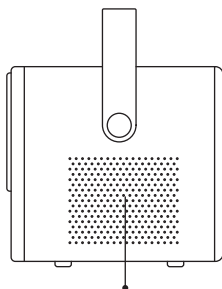

Uscita dell'Aria

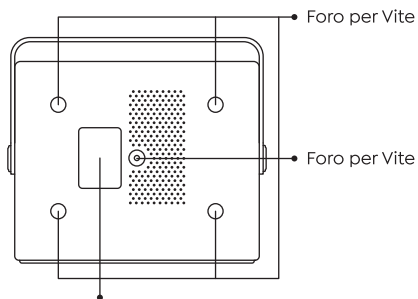

Etichetta del Pulsante

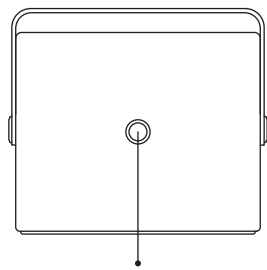

Pulsante di Accensione

Telecomando

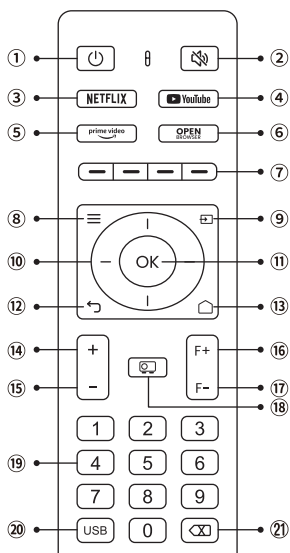

1. Potere
2. Disattiva audio
3. NETFLIX
4. YouTube
5. Primo Video
6. Apri BROWSER
7. Tasti Rosso/Verde/Giallo/Blu
8. Menù
9. Fonte
10. Tasti freccia
11. Tasto di conferma
12. Indietro
13. Homepaper
14. Volume+
15. Volume-
16. Focus+
17. Focus-
18. Modalità di proiezione
19. Numero
20. USB
21. Indietro

Installazione Della Base

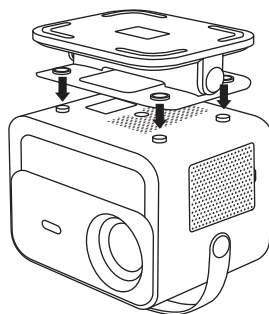
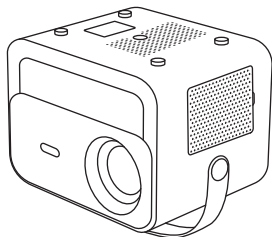

1. Capovolgere la macchina, con il lato posteriore rivolto verso l'alto.

2. Abbinare i fori della base ai fori delle viti sul proiettore.

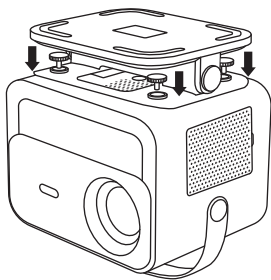

3. Stringere le viti nella scatola degli accessori.

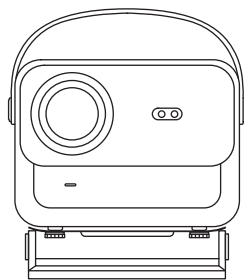

4. Completare l'installazione.

Accendi il Proiettore Yaber

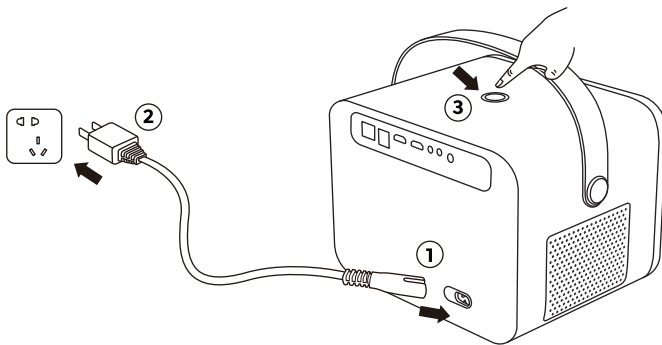

Regolare l'Angolo e la Definizione

Regolazione dell'Immagine

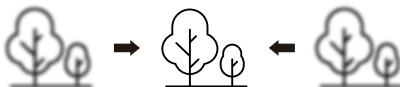
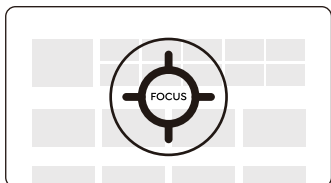

Se l'immagine non è chiara. È possibile utilizzare la funzione di messa a fuoco elettrica e premere i pulsanti di messa a fuoco "F+" e "F-" sul telecomando per regolare la messa a fuoco dell'obiettivo, fino a quando l'immagine è chiara.

Nota: se è ancora sfocato, provare a spostare il proiettore alla distanza migliore. La migliore distanza di proiezione è di 2-3 metri.

Connetti Dispositivi

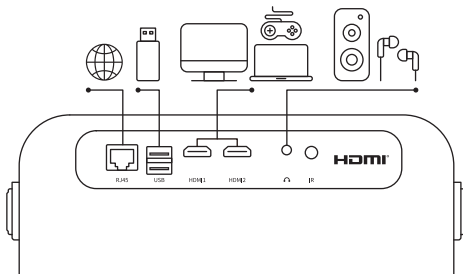

Il proiettore Yaber V12 è dotato di 6 porte, porta di rete cablata, porta USB*2/porta HDMI*2/porta per cuffie. Seleziona la porta di connessione corretta per collegare il tuo dispositivo (PC, telefono, lettore DVD, soundbar, USB, PS4 ecc.)

1.Per altri Dispositivi

Se utilizzi altri dispositivi di sistema, scansiona il QR alla fine di questo QSG per ottenere maggiori informazioni sul mirroring dello schermo. Oppure non esitare a contattarci all'indirizzo service@yaber.com

2.Miracast (Per Dispositivi Android)

Per attivare questa funzione, il tuo dispositivo Android deve supportare Multi-Screen / Wireless Schermo. Il nome "Multi-Screen" può variare a seconda delle varie marche di dispositivi Android.

Passaggio 1: collega il telefono al WiFi.

Passaggio 2: accendere il proiettore e aprire l'APP "ScreenCast" sul proiettore.

Passaggio 3: attiva il "Display multischermo/wireless" del tuo dispositivo Android.

Passaggio 4: selezionare "Proiettore Yaber-V12/Proiettore Smart" dai risultati della ricerca per connettersi.

Passaggio 5: successo.

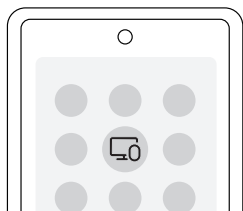
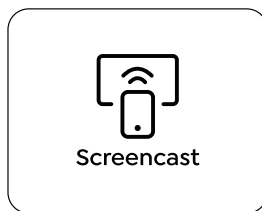
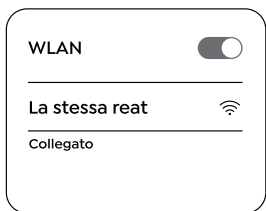

3. Collegare i Dispositivi Tramite la Porta HDMI

1. Collega la chiavetta TV o il laptop a qualsiasi porta HDMI del proiettore.
2. Accedere alla home page per selezionare l'HDMI corrispondente come sorgente del segnale.

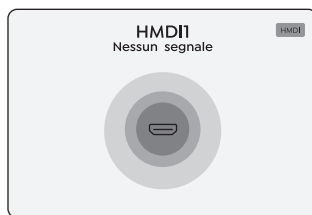

Impostazioni Bluetooth

1. Apri il tuo dispositivo Bluetooth.
2. Vai alla home page - Seleziona [🔗] - Seleziona il menu [Impostazioni Bluetooth] - Apri la funzione Bluetooth - Seleziona il tuo dispositivo Bluetooth - Premi il pulsante OK per connetterti.

Nota:

Il proiettore V12 è compatibile con le cuffie Bluetooth, gli altoparlanti Bluetooth e gli Airpod, ma non con le tastiere Bluetooth o i telefoni Bluetooth.



Scansiona e scarica il manuale utente in PDF

Dove Ottenere Ulteriore Aiuto

✉ service@yaber.com ✉ aftersales@yaber.com 🌐 www.yaber.com

▶ [@yaberofficial](https://www.youtube.com/@yaberofficial)  [Yaber](https://www.facebook.com/Yaber)  [yaberprojector.us](https://discord.com/invite/yaberprojector.us)

Yaber

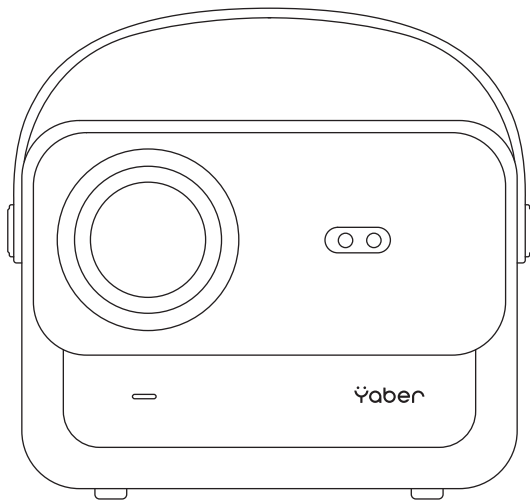

Guía de Inicio Rápido

V12 PROYECTOR **ES**

Contenidos del Paquete

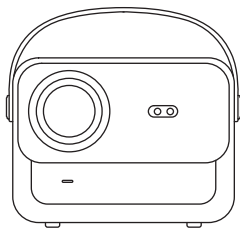

V12 Proyector

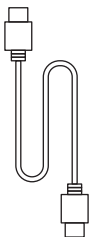

Cable HDMI

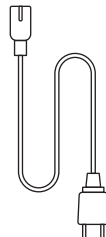

Cable de Energía



Control Remoto

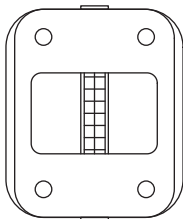

Base del Proyector

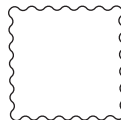

Paño de Limpieza

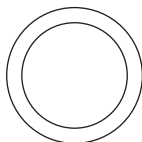

Cubierta de Lente



Guía de Inicio Rápido

Descripción del Producto

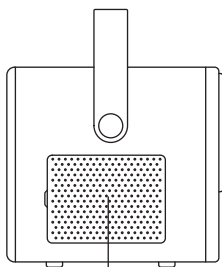
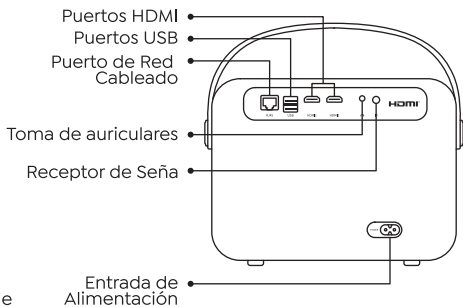
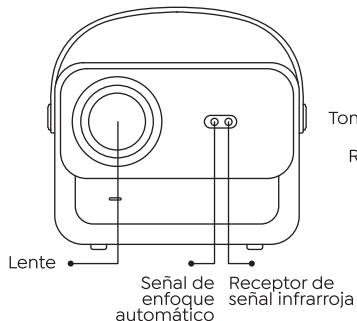

Red Desmontable a Prueba de Polvo

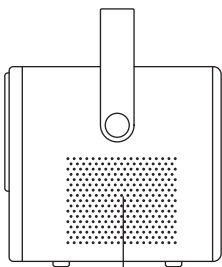

Salida de Aire

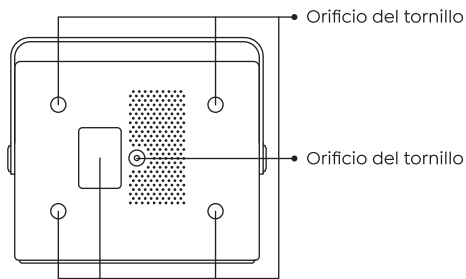

Etiqueta del Botón

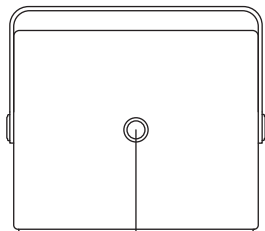

Botón de Encendido

Control Remoto

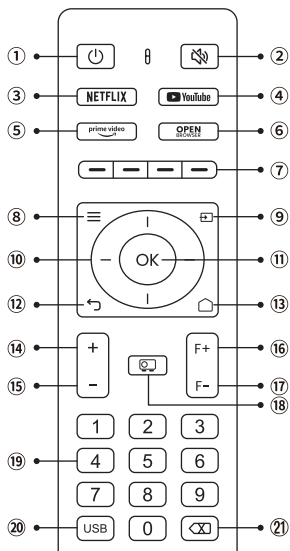

1. Poder
2. Silenciar
3. NETFLIX
4. YouTube
5. Prime Video
6. Navegador Abierto
7. Teclas Roja/Verde/Amarilla/Azul
8. Menú
9. Fuente
10. Teclas de Flecha
11. Clave de Confirmación
12. Atrás
13. Inicio
14. Volumen+
15. Volumen-
16. Focus+
17. Focus-
18. Modo de proyección
19. Número
20. USB
21. Retroceso

Instalación Básica

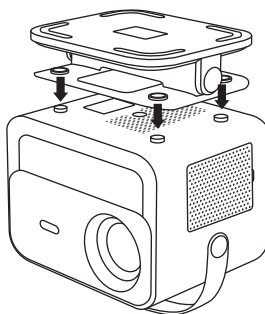
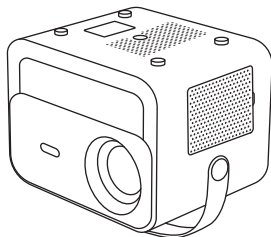

1. Dé la vuelta a la máquina, con la parte posterior hacia arriba.

2. Haga coincidir los agujeros de la base con el tornillo.

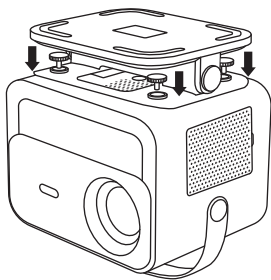

3. Apriete los tornillos en la caja de accesorios.

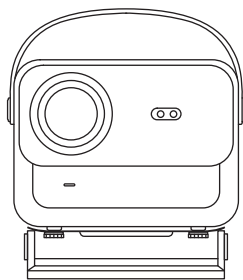

4. Complete la instalación.

Enciende el Proyector Yaber

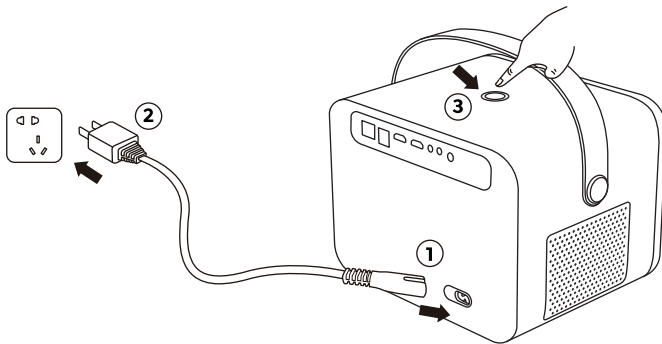

Ajustar el ángulo y la Definición

Ajuste de Imagen

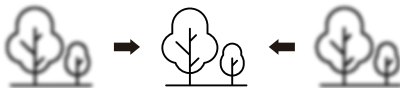
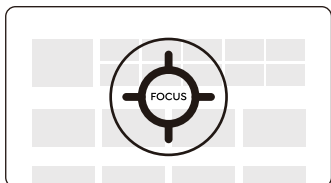

Si la imagen no es clara. Puede utilizar la función de enfoque eléctrico y presionar los botones de enfoque "F+" y "F-" en el control remoto para ajustar el enfoque de la lente, hasta que la imagen sea clara.

Nota: Si aún está borroso, intente mover el proyector a la mejor distancia. La mejor distancia de proyección es de 2 a 3 metros.

Conectar Dispositivos

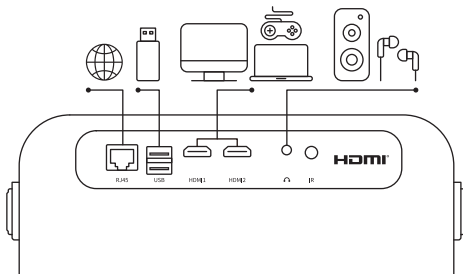

El proyector Yaber V12 tiene 6 puertos, puerto de red cableado, puerto USB*2/puerto HDMI*2/puerto para auriculares. Seleccione el puerto de conexión correcto para conectar su dispositivo (PC, teléfono, reproductor de DVD, barra de sonido, USB, PS4, etc.)

1.Para Otros Dispositivos

Si está utilizando otros dispositivos del sistema, escanee el QR al final de este QSG para obtener más información sobre la duplicación de pantalla. O no dude en contactarnos en service@yaber.com

2.Miracast (para dispositivos Android)

Para activar esta función, su dispositivo Android debe admitir pantalla múltiple/pantalla inalámbrica. El nombre de "Multipantalla" puede variar según las distintas marcas de dispositivos Android.

Paso 1: Conecta tu teléfono a WIFI

Paso 2: Encienda el proyector y abra la App "ScreenCast" en el proyector

Paso 3: Encienda la "Pantalla múltiple/Pantalla inalámbrica" de su dispositivo Android.

Paso 4: Seleccione "Proyector Yaber-V12/Proyector inteligente" de los resultados de la búsqueda para conectarse.

Paso 5: Tenga éxito.

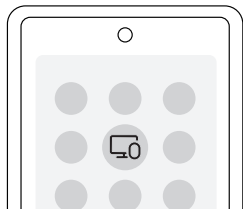
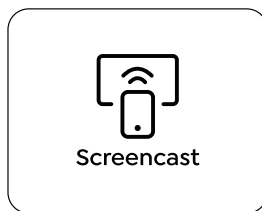

3. Conecte los dispositivos a través del puerto HDMI

1. Conecte su TV Stick o computadora portátil a cualquier puerto HDMI del proyector.
2. Ingrese a la página de inicio para seleccionar el HDMI correspondiente como fuente de señal.

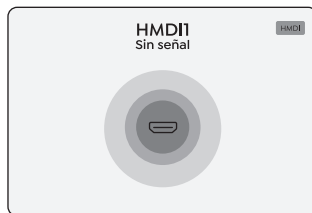

Configuración de Bluetooth

1. Abra su dispositivo Bluetooth.
2. Vaya a la página de inicio - Seleccione el menú [🔗] - Seleccione el menú [Configuración de Bluetooth] - Abra la función Bluetooth - Seleccione su dispositivo Bluetooth - Presione el botón OK para conectarse.

Nota:

El proyector V12 es compatible con auriculares Bluetooth, altavoces Bluetooth y AirPods, pero no con teclados Bluetooth ni teléfonos Bluetooth.



Escanee y descargue el manual de usuario en PDF

Dónde Obtener Más Ayuda

✉ service@yaber.com ✉ aftersales@yaber.com 🌐 www.yaber.com

▶ [@yaberofficial](https://www.youtube.com/@yaberofficial)  [Yaber](https://www.facebook.com/Yaber)  [yaberprojector.us](https://discord.com/invite/yaberprojector.us)

Yaber

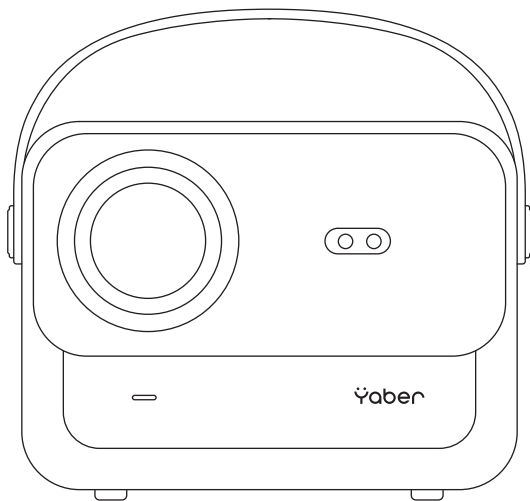

クイックスタートガイド

V12 プロジェクター **JP**

パッケージ内容

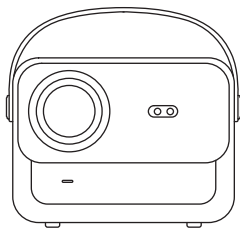

V12 プロジェクター

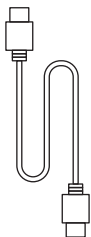

HDMI ケーブル

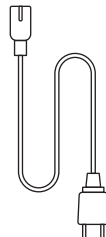

電源コード



プロジェクターリモコン

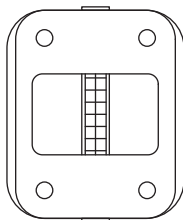

プロジェクターベース



クリーニング布

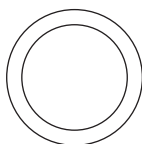

レンズカバー



クイックスタートガイド

製品概要

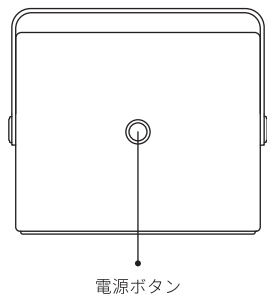
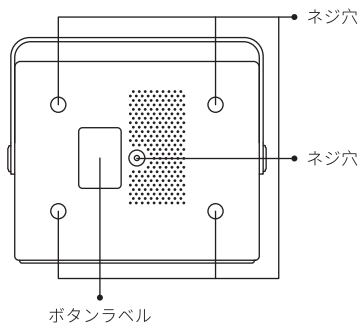
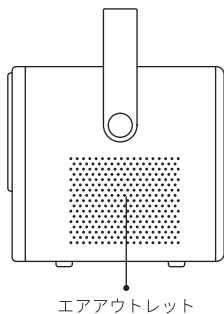
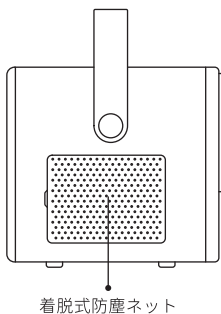
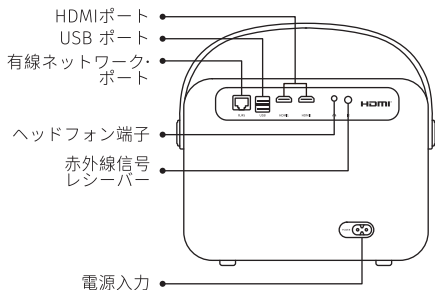
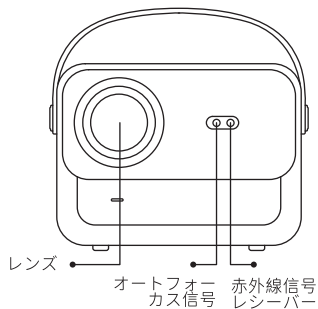

リモコン

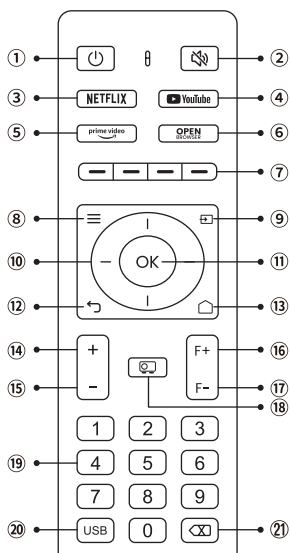

1. パワー
2. ミュート
3. ネットフリックス
4. YouTube
5. プライムビデオ
6. ブラウザを開く
7. 赤/緑/黄/青キー
8. メニュー
9. ソース
10. 矢印キー
11. 確認キー
12. 戻る
13. ホームページ
14. 音量+
15. 音量-
16. フォーカス+
17. フォーカス-
18. 投影モード
19. 数字
20. USB
21. バックスペース

ベース設置

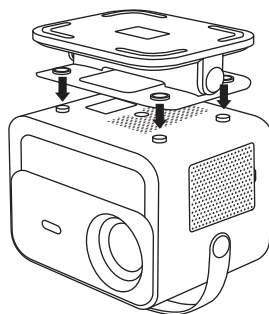
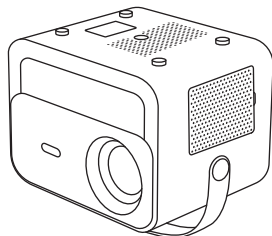

1. マシンを裏返し、裏側を上に出します。

2. ベースの穴をプロジェクターのネジに合わせます。

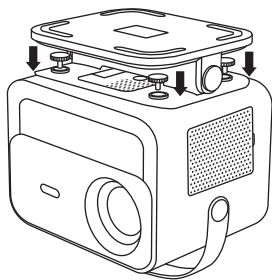

3. 付属品ボックスのネジを締めます。

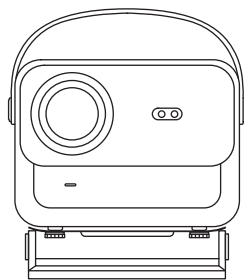

4. インストールを完了します。

Yaber プロジェクターを起動

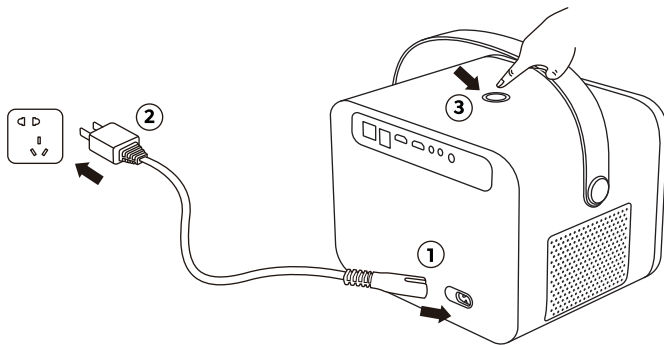

アングルとデフィニションの調整

画像調整

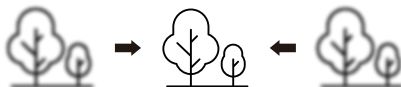
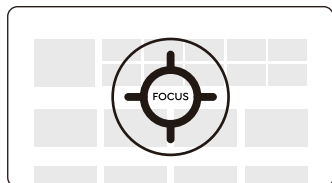

画像が鮮明でない場合。電動フォーカス機能を使用し、リモコンのフォーカスボタン「F+」と「F-」を押して、画像が鮮明になるまでレンズの焦点を調整できます。

注: それでもぼやける場合は、プロジェクターを最適な距離に移動してみてください。最適な投影距離は2~3メートルです。

デバイスを接続する

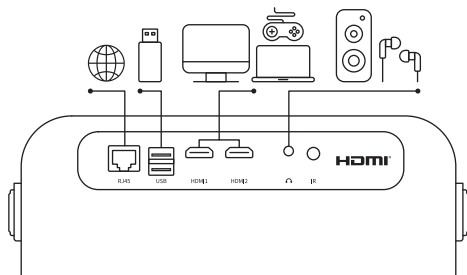

Yaber V12プロジェクターは6ポート、有線ネットワークポート、USBポート*2 / HDMIポート*2 / ヘッドフォンポート。デバイス(PC、電話、DVDプレーヤー、サウンドバー、USB、PS4など)を接続するには、正しい接続ポートを選択してください。

1.その他のデバイスの場合

他のシステムデバイスを使用している場合は、このQSGの最後にあるQRをスキャンして、画面ミラーリングの詳細情報を取得してください。または、service@yaber.comまでお気軽にお問い合わせください。

2.Miracast (Android デバイス用)

この機能を有効にするには、Androidデバイスがマルチスクリーン/ワイヤレスディスプレイをサポートする必要があります。「マルチスクリーン」の名前は、Androidデバイスのさまざまなブランドによって異なる場合があります。

Step 1: スマホをWiFiに接続する

Step 2: Tプロジェクターの電源を入れ、プロジェクターで「スクリーンキャスト」アプリを開きます。

Step 3: Androidデバイスの「マルチスクリーン/ワイヤレスディスプレイ」をオンにします。

Step 4: 検索結果から「Yaber-V12プロジェクター/スマートプロジェクター」を選択して接続します。

Step 5: 成功します。

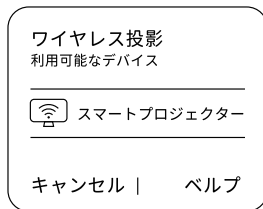
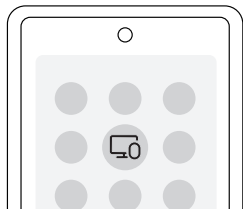

3.HDMIポート経由でデバイスを接続する

1. テレビスティックやノートパソコンをプロジェクターのHDMIポートに接続してください。
2. ホームページに入り、対応するHDMIを信号ソースとして選択します。



Bluetoothの設定

1. Bluetoothデバイスを開く。
2. ホーム画面に移動する - [設定] メニューを選択する - [Bluetooth設定] メニューを選択する - Bluetooth機能を開く - Bluetoothデバイスを選択する - OKボタンを押して接続する。

ノート:

V12プロジェクターは、Bluetoothヘッドセット、Bluetoothスピーカー、Airpodsには対応しているが、BluetoothキーボードやBluetooth電話には対応していない。



PDF取扱説明書をスキャンしてダウンロードする

その他のヘルプの入手先

✉ service@yaber.com ✉ aftersales@yaber.com 🌐 www.yaber.com

▶ [@yaberofficial](https://www.youtube.com/@yaberofficial)  [Yaber](https://www.facebook.com/Yaber)  [yaberprojector.us](https://discord.com/invite/yaberprojector.us)

FCC Warning

This device complies with part 15 of the FCC Rules. Operation is subject to the following two conditions: (1) This device may not cause harmful interference, and (2) this device must accept any interference received, including interference that may cause undesired operation.

Any Changes or modifications not expressly approved by the party responsible for compliance could void the user's authority to operate the equipment.

Note: This equipment has been tested and found to comply with the limits for a Class B digital device, pursuant to part 15 of the FCC Rules. These limits are designed to provide reasonable protection against harmful interference in a residential installation. This equipment generates uses and can radiate radio frequency energy and, if not installed and used in accordance with the instructions, may cause harmful interference to radio communications. However, there is no guarantee that interference will not occur in a particular installation. If this equipment does cause harmful interference to radio or television reception, which can be determined by turning the equipment off and on, the user is encouraged to try to correct the interference by one or more of the following measures:

- Reorient or relocate the receiving antenna.
- Increase the separation between the equipment and receiver.
- Connect the equipment into an outlet on a circuit different from that to which the receiver is connected.
- Consult the dealer or an experienced radio/TV technician for help.

This equipment complies with FCC radiation exposure limits set forth for an uncontrolled environment. This equipment should be installed and operated with minimum distance 20cm between the radiator & your body.

IC Warning

This device complies with Industry Canada's licence-exempt RSS standard(s). Operation is subject to the following two conditions:

- (1) this device may not cause interference, and
- (2) this device must accept any interference, including interference that may cause undesired operation of the device.

Le présent appareil est conforme aux CNR d'Industrie Canada applicables aux appareils radio exempts de licence. L'exploitation est autorisée aux deux conditions suivantes:

- (1) l'appareil n' doit pas produire de brouillage, et
- (2) l'utilisateur de l'appareil doit accepter tout brouillage radioélectrique subi, même si le brouillage est susceptible d'en compromettre le fonctionnement.

This Class B digital apparatus complies with Canadian ICES-003.

Cet appareil numérique de la classe B est conforme à la norme NMB-003 du Canada.

IC RF Statement:

When using the product, maintain a distance of 20cm from the body to ensure compliance with RF exposure requirements.

Déclaration IC RF:

Lors de l'utilisation du produit, maintenez une distance de 20 cm du corps pour garantir conformité aux exigences d' exposition aux RF.