



RF TEST REPORT

Applicant Quectel Wireless Solutions Co., Ltd
FCC ID XMR201912BG77
Product LTE Cat M1 & Cat NB2 Module
Brand Quectel
Model BG77
Marketing Quectel BG77
Report No. R1909A0576-R8
Issue Date March 13, 2020

TA Technology (Shanghai) Co., Ltd. tested the above equipment in accordance with the requirements in **FCC CFR47 Part 2 / FCC CFR 47 Part 90R**. The test results show that the equipment tested is capable of demonstrating compliance with the requirements as documented in this report.

Performed by: Peng Tao

Approved by: Kai Xu

TA Technology (Shanghai) Co., Ltd.

No.145, Jintang Rd, Tangzhen Industry Park, Pudong Shanghai, China

TEL: +86-021-50791141/2/3

FAX: +86-021-50791141/2/3-8000



TABLE OF CONTENT

1. Test Laboratory	4
1.1. Notes of the Test Report	4
1.2. Test facility	4
1.3. Testing Location	4
2. General Description of Equipment under Test.....	5
2.3. Applicant and Manufacturer Information	5
2.4. General Information.....	5
3. Applied Standards	6
4. Test Configuration.....	7
5. Test Case Results.....	8
5.1. RF Power Output and Effective Isotropic Radiated power.....	8
5.2. Occupied Bandwidth	11
5.3. Band Edge Compliance.....	14
5.4. Peak-to-Average Power Ratio (PAPR)	20
5.5. Frequency Stability.....	22
5.6. Spurious Emissions at Antenna Terminals	25
5.7. Radiates Spurious Emission	29
6. Main Test Instruments	33



Summary of measurement results

No.	Test Case	Clause in FCC rules	Verdict
1	RF power output and Effective Radiated Power	2.1046/90.635 (b)	PASS
2	Occupied Bandwidth	2.1049/ 90.209	PASS
3	Emission Masks	2.1051 / 90.543	PASS
4	Peak-to-Average Power Ratio	KDB 971168 D01(5.7)	PASS
5	Frequency Stability	90.539 (c)	PASS
6	Spurious Emissions at Antenna Terminals	90.543 (e)	PASS
7	Radiates Spurious Emission	90.543 (e)	PASS

Date of Testing: December 13, 2019 ~January 14, 2020

Note: PASS: The EUT complies with the essential requirements in the standard.
FAIL: The EUT does not comply with the essential requirements in the standard.
All indications of Pass/Fail in this report are opinions expressed by TA Technology (Shanghai) Co., Ltd. based on interpretations and/or observations of test results. Measurement Uncertainties were not taken into account and are published for informational purposes only.



1. Test Laboratory

1.1. Notes of the Test Report

This report shall not be reproduced in full or partial, without the written approval of **TA technology (shanghai) co., Ltd.** The results documented in this report apply only to the tested sample, under the conditions and modes of operation as described herein .Measurement Uncertainties were not taken into account and are published for informational purposes only. This report is written to support regulatory compliance of the applicable standards stated above.

1.2. Test facility

FCC (Designation number: CN1179, Test Firm Registration Number: 446626)

TA Technology (Shanghai) Co., Ltd. has been listed on the US Federal Communications Commission list of test facilities recognized to perform electromagnetic emissions measurements.

A2LA (Certificate Number: 3857.01)

TA Technology (Shanghai) Co., Ltd. has been listed by American Association for Laboratory Accreditation to perform electromagnetic emission measurement.

1.3. Testing Location

Company: TA Technology (Shanghai) Co., Ltd.
Address: No.145, Jintang Rd, Tangzhen Industry Park, Pudong
City: Shanghai
Post code: 201201
Country: P. R. China
Contact: Xu Kai
Telephone: +86-021-50791141/2/3
Fax: +86-021-50791141/2/3-8000
Website: <http://www.ta-shanghai.com>
E-mail: xukai@ta-shanghai.com

2. General Description of Equipment under Test

2.3. Applicant and Manufacturer Information

Applicant	Quectel Wireless Solutions Co., Ltd
Applicant address	Building 5, Shanghai Business Park Phase III (Area B), No.1016 Tianlin Road, Minhang District, Shanghai, China 200233
Manufacturer	Quectel Wireless Solutions Co., Ltd
Manufacturer address	Building 5, Shanghai Business Park Phase III (Area B), No.1016 Tianlin Road, Minhang District, Shanghai, China 200233

2.4. General Information

EUT Description			
Model	BG77		
IMEI	866349040016200		
Hardware Version	R1.2		
Software Version	BG77LAR02A02		
Power Supply	External Power Supply		
Antenna Type	The EUT don't have standard Antenna, The Antenna used for testing in this report is the after-market accessory (Dipole Antenna)		
Antenna Gain	4.45dBi		
Test Mode(s)	LTE Band 14;		
Test Modulation	QPSK 16QAM;		
LTE Category	M1		
Maximum E.R.P.	LTE Band 14: 22.47dBm		
Rated Power Supply Voltage	3.3V		
Extreme Voltage	Minimum: 2.6V Maximum: 4.8V		
Extreme Temperature	Lowest: -40°C Highest: +85°C		
Operating Frequency Range(s)	Band	Tx (MHz)	Rx (MHz)
	LTE Band 14	788 ~ 798	758 ~ 768
Note: 1. The EUT is sent from the applicant to TA and the information of the EUT is declared by the applicant.			



3. Applied Standards

According to the specifications of the manufacturer, it must comply with the requirements of the following standards:

Test standards:

FCC CFR 47 Part 90R (2019)

ANSI C63.26 (2015)

Reference standard:

FCC 47 CFR Part 2 (2019)

KDB 971168 D01 Power Meas License Digital Systems v03r01

4. Test Configuration

Radiated measurements are performed by rotating the EUT in three different orthogonal test planes. EUT stand-up position (Z axis), lie-down position (X, Y axis). Receiver antenna polarization (horizontal and vertical), the worst emission was found in position (X axis, horizontal polarization) and the worst case was recorded.

All mode and data rates and positions were investigated.

The following testing in LTE is set based on the maximum RF Output Power.

Test modes are chosen as the worst case configuration below for LTE Band 14

Test items	Bandwidth (MHz)		Modulation		RB			Test Channel		
	5	10	QPSK	16QAM	1	50%	100%	L	M	H
RF power output and Effective Isotropic Radiated power	O	O	O	O	O	O	O	O	O	O
Occupied Bandwidth	O	O	O	O	-	-	O	O	O	O
Band Edge Compliance	O	O	O	O	-	-	O	O	-	O
Peak-to-Average Power Ratio	O	O	O	O	-	-	O	O	O	O
Frequency Stability	O	O	O	O	-	-	O	O	O	O
Spurious Emissions at Antenna Terminals	O	O	O	-	O	-	-	O	O	O
Radiates Spurious Emission	O	O	O	-	O	-	-	-	O	-
Note	1. The mark "O" means that this configuration is chosen for testing. 2. The mark "-" means that this configuration is not testing.									

5. Test Case Results

5.1. RF Power Output and Effective Isotropic Radiated power

Ambient condition

Temperature	Relative humidity	Pressure
23°C ~25°C	45%~50%	101.5kPa

Methods of Measurement

1. The testing follows FCC KDB 971168 v03r01 Section 5.8 and **ANSI C63.26 (2015)**.

a) Connect the equipment as illustrated. Mount the equipment with the manufacturer specified antenna in a vertical orientation on a manufacturer specified mounting surface located on a non-conducting rotating platform of a RF anechoic chamber (preferred) or a standard radiation site.

b) Key the transmitter, then rotate the EUT 360° azimuthally and record spectrum analyzer power level (LVL) measurements at angular increments that are sufficiently small to permit resolution of all peaks. If a standard radiation test site is used, raise and lower the test antenna to obtain a maximum reading at each angular increment. (Note: several batteries may be needed to offset the effect of battery voltage droop, which should not exceed 5% of the manufactured specified battery voltage during transmission).

c) Replace the transmitter under test with a vertically polarized half-wave dipole (or an antenna whose gain is known relative to an ideal half-wave dipole). The center of the antenna should be at the same location as the center of the antenna under test.

d) Connect the antenna to a signal generator with a known output power and record the path loss (in dB) as LOSS. If a standard radiation test site is used, raise and lower the test antenna to obtain a maximum reading. $LOSS = \text{Generator Output Power (dBm)} - \text{Analyzer reading (dBm)}$

e) Determine the effective radiated output power at each angular position from the readings in steps b) and d) using the following equation: $ERP \text{ (dBm)} = LVL \text{ (dBm)} + LOSS \text{ (dB)}$

f) The maximum ERP is the maximum value determined in the preceding step.

g) When calculating ERP, in addition to knowing the antenna radiation and matching characteristics, it is necessary to know the loss values of all elements (e.g. transmission line attenuation, mismatches, filters, combiners) interposed between the point where transmitter output power is measured, and the point where power is applied to the antenna. ERP can then be calculated as follows:

$$EIRP \text{ (dBm)} = \text{Output Power (dBm)} - \text{Losses (dB)} + \text{Antenna Gain (dBi)}$$

where: dBd refers to gain relative to an ideal dipole.

$$EIRP \text{ (dBm)} = ERP \text{ (dBm)} + 2.15 \text{ (dB.)}$$

Test setup

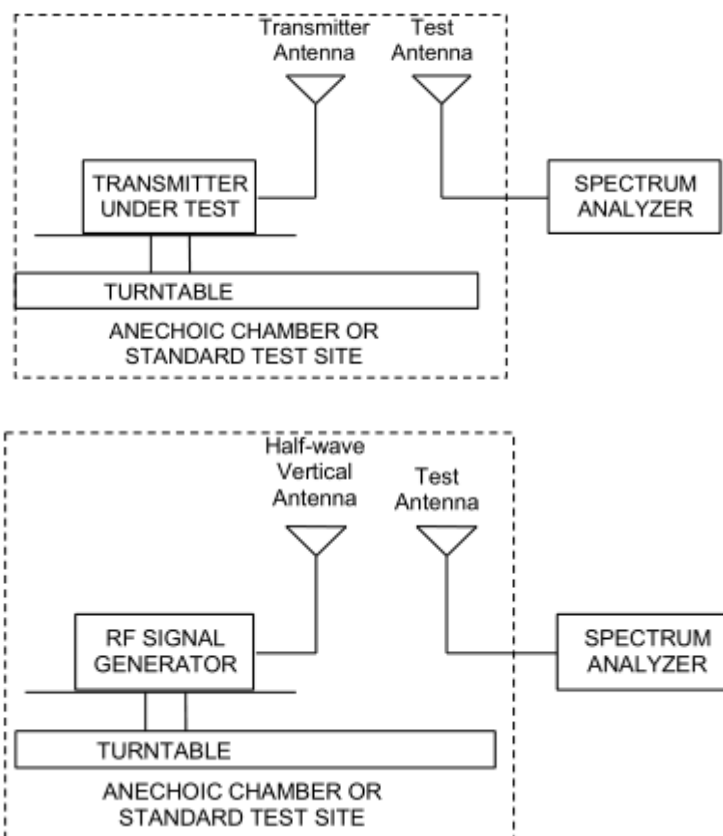

Note: Area side:2.4mX3.6m

The radiated emission was measured in the following position: EUT stand-up position (Z axis), lie-down position (X, Y axis). The worst emission was found in stand-up position (Z axis) and the worst case was recorded.

Limits

90.542(7) Portable stations (hand-held devices) transmitting in the 758-768 MHz band and the 788-798 MHz band are limited to 3 watts ERP.

Part 90.635 (b) the maximum output power of the transmitter for mobile stations is 100 watts.

Measurement Uncertainty

The assessed measurement uncertainty to ensure 95% confidence level for the normal distribution is with the coverage factor $k = 2$, $U = 0.4$ dB.

**Test Results**

LTE Band14	Channel/ Frequency(MHz)	Index	RB# RBstart	Conducted Power (dBm)		ERP (dBm)	
				QPSK	16QAM	QPSK	16QAM
5MHz	23305/790.5	0	1#0	20.84	20.53	22.16	21.85
		0	6#0	19.80	19.07	21.12	20.39
	23330/793	0	1#0	20.90	20.58	22.22	21.90
		0	6#0	19.85	19.14	21.17	20.46
	23355/795.5	3	1#5	21.01	20.66	22.33	21.98
		3	6#0	20.03	19.23	21.35	20.55
10MHz	23330/793	0	1#0	20.70	21.15	22.02	22.47
		0	4#0	20.78	20.09	22.10	21.41

5.2. Occupied Bandwidth

Ambient condition

Temperature	Relative humidity	Pressure
23°C ~25°C	45%~50%	101.5kPa

Method of Measurement

The EUT was connected to Spectrum Analyzer and Base Station Simulator via power Splitter. The occupied bandwidth is measured using spectrum analyzer.

RBW is set to 51 kHz, VBW is set to 160 kHz for LTE Band 14 (5MHz/10MHz).

99% power and -26dBc occupied bandwidths are recorded. Spectrum analyzer plots are included on the following pages.

Test Setup

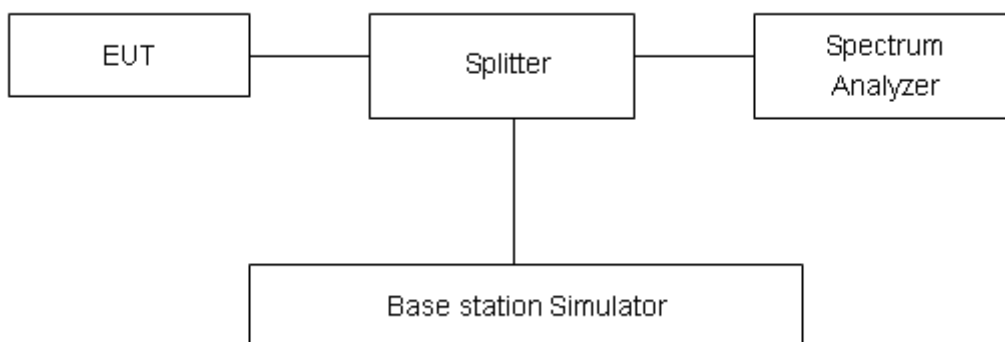

Limits

No specific occupied bandwidth requirements in part 2.1049.

Part 90.209 (a) Each authorization issued to a station licensed under this part will show an emission designator representing the class of emission authorized. The designator will be prefixed by a specified necessary bandwidth. This number does not necessarily indicate the bandwidth occupied by the emission at any instant. In those cases where part 2.202 of this chapter does not provide a formula for the computation of necessary bandwidth, the occupied bandwidth, as defined in part 2 of this chapter, may be used in lieu of the necessary bandwidth.

Measurement Uncertainty

The assessed measurement uncertainty to ensure 95% confidence level for the normal distribution is with the coverage factor $k = 2$, $U = 624\text{Hz}$.

**Test Result**

Mode	Bandwidth	Modulation	Channel/ Frequency(MHz)	RB	Index	Bandwidth(MHz)	
						99% Power	-26dBc
Band14	5MHz	QPSK	23330/793	6#0	0	1.1123	1.327
		16QAM	23330/793	6#0	0	0.9472	1.248
	10MHz	QPSK	23330/793	6#0	0	1.1141	1.327
		16QAM	23330/793	6#0	0	0.9631	1.173

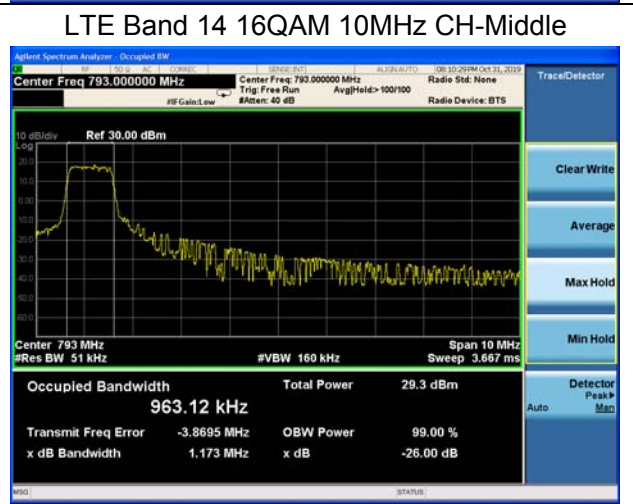
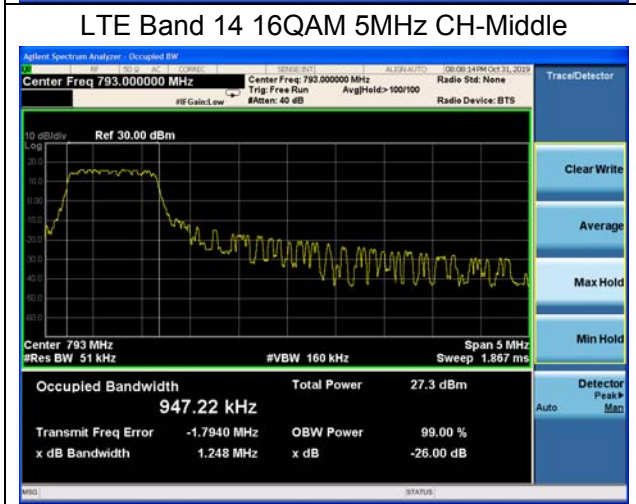
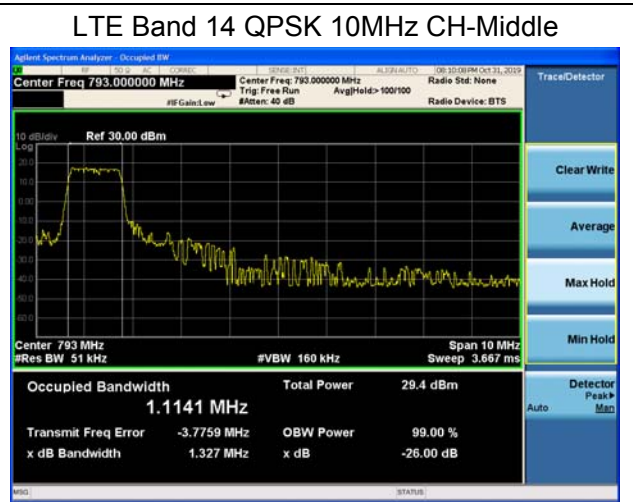
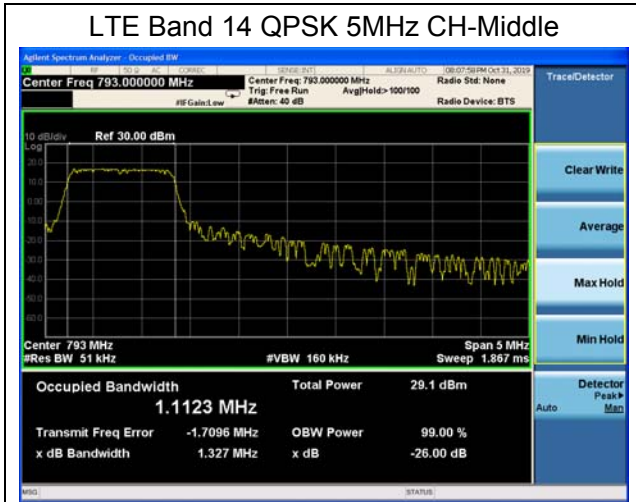

5.3. Band Edge Compliance

Ambient condition

Temperature	Relative humidity	Pressure
23°C ~25°C	45%~50%	101.5kPa

Method of Measurement

The EUT was connected to Spectrum Analyzer and Base Station Simulator via power Splitter. The band edge of the lowest and highest channels were measured.

The testing follows KDB 971168 v03r01 Section 6.0

- 1.The EUT was connected to spectrum analyzer and system simulator via a power divider.
2. The band edges of low and high channels for the highest RF powers were measured. RBW is set to 6.8 kHz, VBW is set to 22 kHz for LTE Band 14 (769MHz~775MHz). RBW is set to 100 kHz, VBW is set to 300 kHz for LTE Band 14 (775MHz~787.9MHz). RBW is set to 6.8 kHz, VBW is set to 22 kHz for LTE Band 14 (799MHz~805MHz).
3. Set spectrum analyzer with RMS detector.
4. The RF fundamental frequency should be excluded against the limit line in the operating frequency band.
5. Checked that all the results comply with the emission limit line.

Test Setup

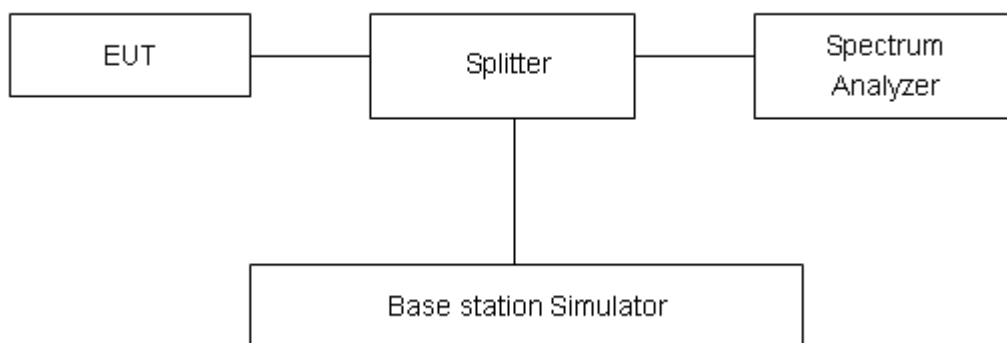

Limits

90.543 Emission limitations (e) For operations in the 758-768 MHz and the 788-798 MHz bands, the power of any emission outside the licensee's frequency band(s) of operation shall be attenuated below the transmitter power (P) within the licensed band(s) of operation, measured in watts, in accordance with the following:

- (1) On all frequencies between 769-775 MHz and 799-805 MHz, by a factor not less than $76 + 10 \log(P)$ dB in a 6.25 kHz band segment, for base and fixed stations.



(2) On all frequencies between 769-775 MHz and 799-805 MHz, by a factor not less than $65 + 10 \log (P)$ dB in a 6.25 kHz band segment, for mobile and portable stations.

(3) On any frequency between 775-788 MHz, above 805 MHz, and below 758 MHz, by at least $43 + 10 \log (P)$ dB.

(4) Compliance with the provisions of paragraphs (e)(1) and (2) of this section is based on the use of measurement instrumentation such that the reading taken with any resolution bandwidth setting should be adjusted to indicate spectral energy in a 6.25 kHz segment.

(5) Compliance with the provisions of paragraph (e)(3) of this section is based on the use of measurement instrumentation employing a resolution bandwidth of 100 kHz or greater. However, in the 100 kHz bands immediately outside and adjacent to the frequency block, a resolution bandwidth of 30 kHz may be employed.

(f) For operations in the 758-775 MHz and 788-805 MHz bands, all emissions including harmonics in the band 1559-1610 MHz shall be limited to -70 dBW/MHz equivalent isotropically radiated power (EIRP) for wideband signals, and -80 dBW EIRP for discrete emissions of less than 700 Hz bandwidth. For the purpose of equipment authorization, a transmitter shall be tested with an antenna that is representative of the type that will be used with the equipment in normal operation.

Measurement Uncertainty

The assessed measurement uncertainty to ensure 95% confidence level for the normal distribution is with the coverage factor $k = 1.96$, $U=0.684$ dB.



Test Result:

LTE Band 14 QPSK 5MHz 1 RB
(769MHz ~775MHz)

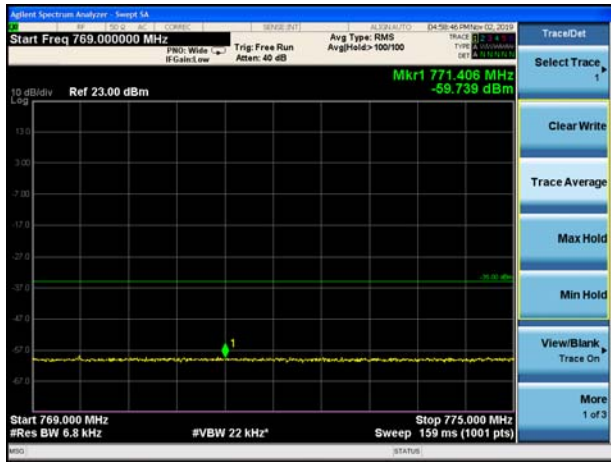

LTE Band 14 QPSK 10MHz 1 RB
(769MHz ~775MHz)

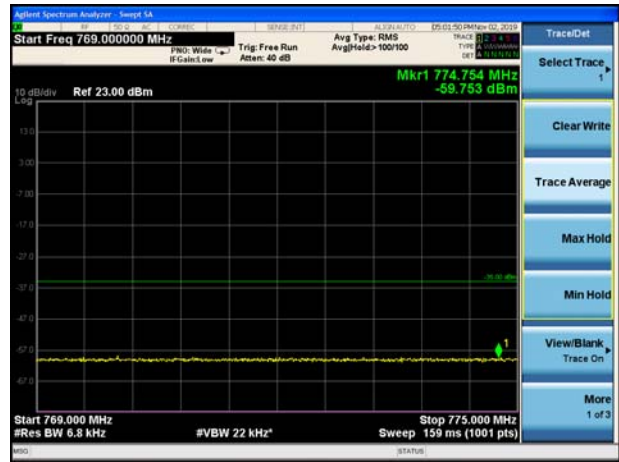

LTE Band 14 QPSK 5MHz 1 RB
(775MHz ~787.9MHz)

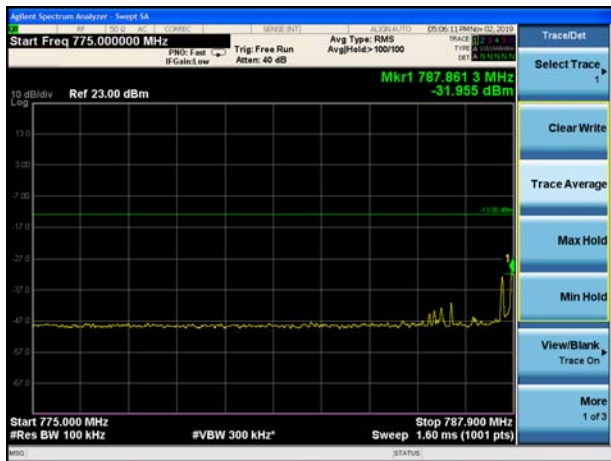

LTE Band 14 QPSK 10MHz 1 RB
(775MHz ~787.9MHz)

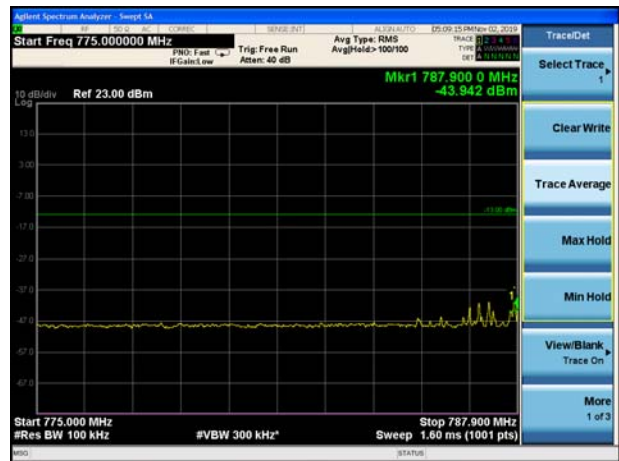

LTE Band 14 QPSK 5MHz 1 RB
(799MHz ~805MHz)

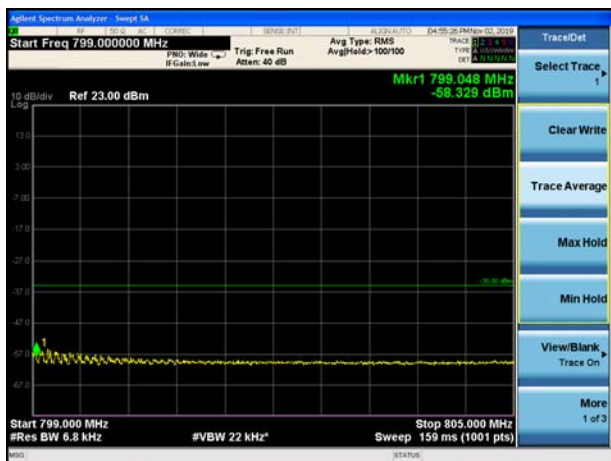

LTE Band 14 QPSK 10MHz 1 RB
(799MHz ~805MHz)

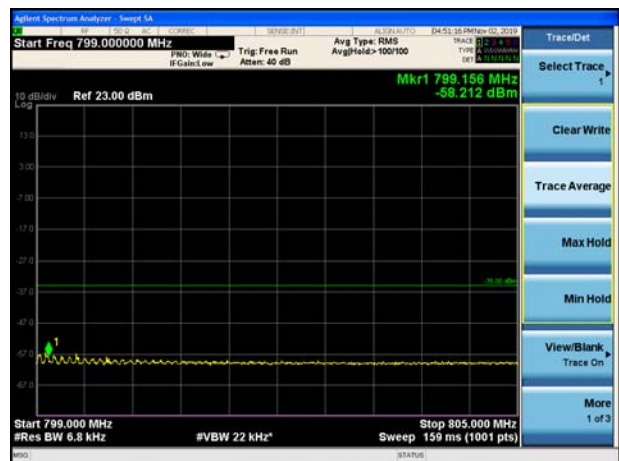



LTE Band 14 QPSK 5MHz 100%RB
(769MHz ~775MHz)

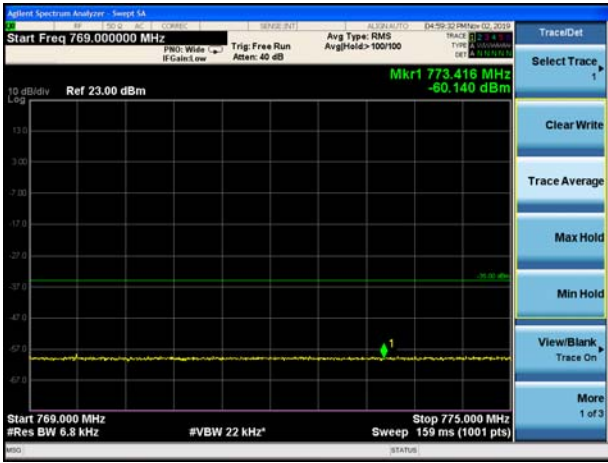

LTE Band 14 QPSK 10MHz 100%RB
(769MHz ~775MHz)

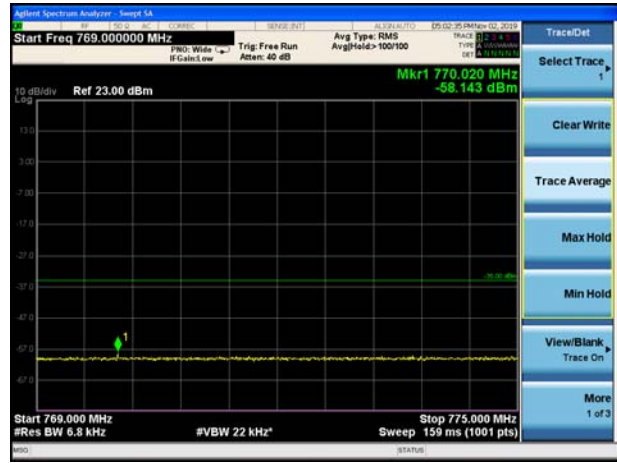

LTE Band 14 QPSK 5MHz 100%RB
(775MHz ~787.9MHz)



LTE Band 14 QPSK 10MHz 100%RB
(775MHz ~787.9MHz)



LTE Band 14 QPSK 5MHz 100%RB
(799MHz ~805MHz)

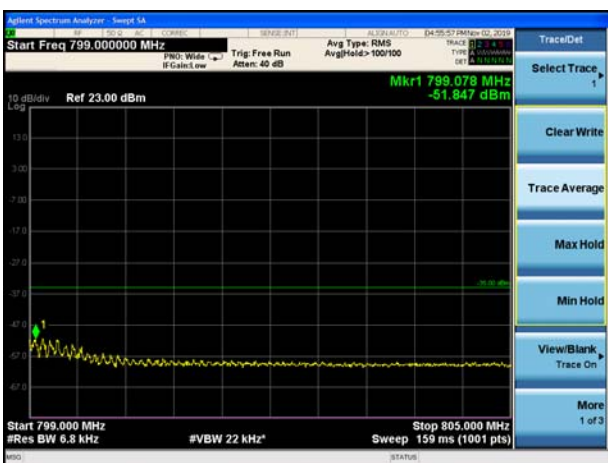

LTE Band 14 QPSK 10MHz 100%RB
(799MHz ~805MHz)

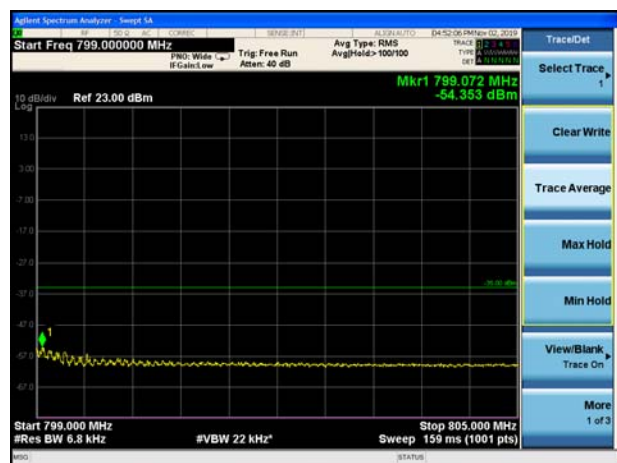



LTE Band 14 16QAM 5MHz 1 RB
(769MHz ~775MHz)

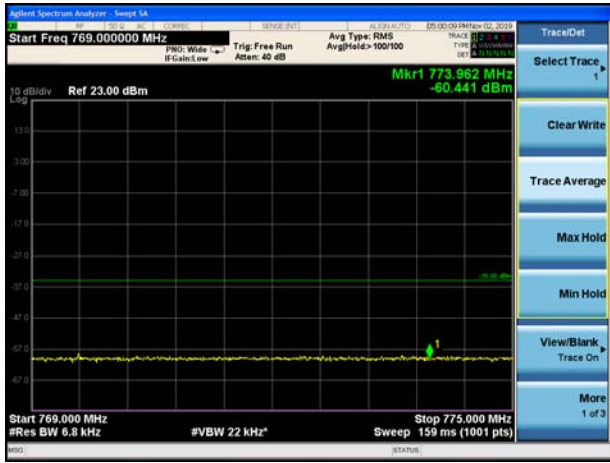

LTE Band 14 16QAM 10MHz 1 RB
(769MHz ~775MHz)

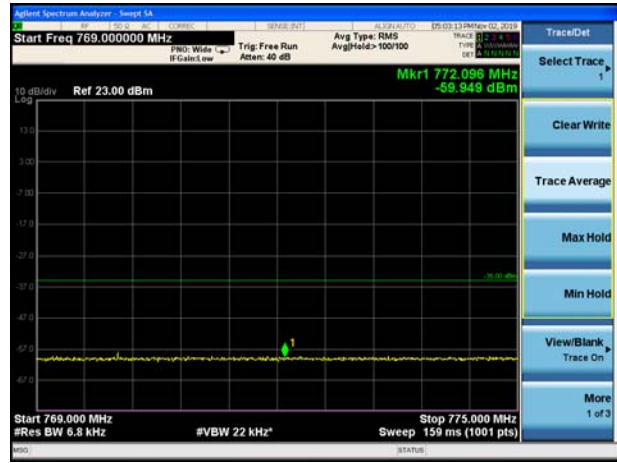

LTE Band 14 16QAM 5MHz 1 RB
(775MHz ~787.9MHz)

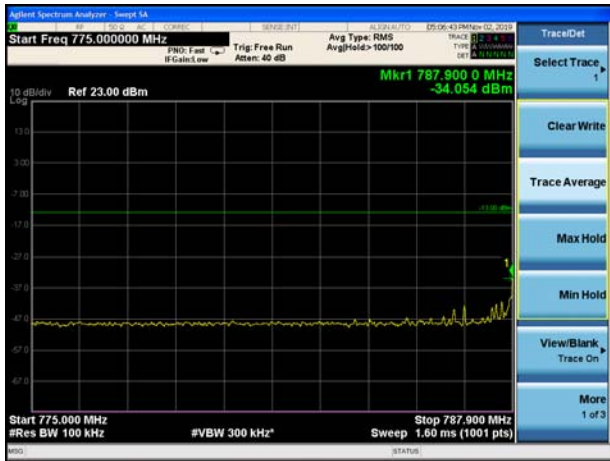

LTE Band 14 16QAM 10MHz 1 RB
(775MHz ~787.9MHz)

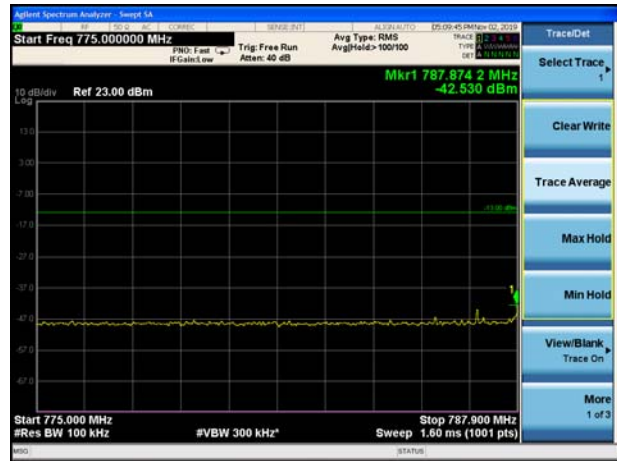

LTE Band 14 16QAM 5MHz 1 RB
(799MHz ~805MHz)

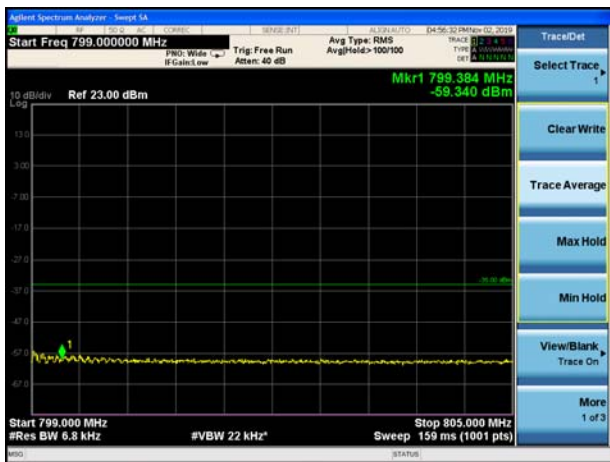

LTE Band 14 16QAM 10MHz 1 RB
(799MHz ~805MHz)

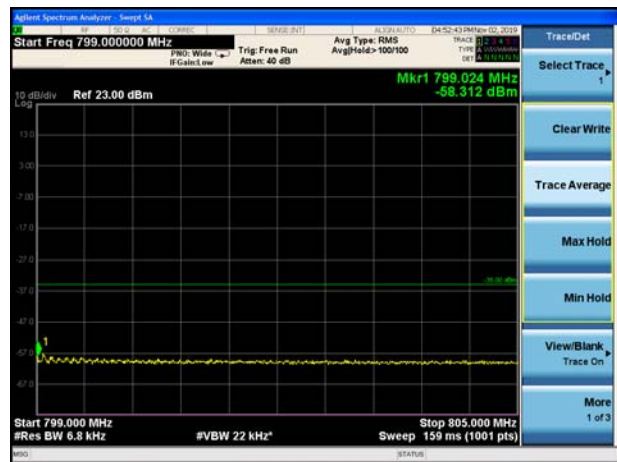



LTE Band 14 16QAM 5MHz 100%RB
(769MHz ~775MHz)

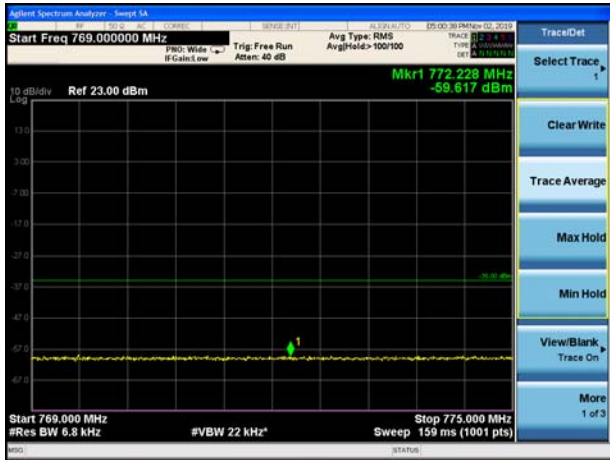

LTE Band 14 16QAM 10MHz 100%RB
(769MHz ~775MHz)



LTE Band 14 16QAM 5MHz 100%RB
(775MHz ~787.9MHz)



LTE Band 14 16QAM 10MHz 100%RB
(775MHz ~787.9MHz)



LTE Band 14 16QAM 5MHz 100%RB
(799MHz ~805MHz)

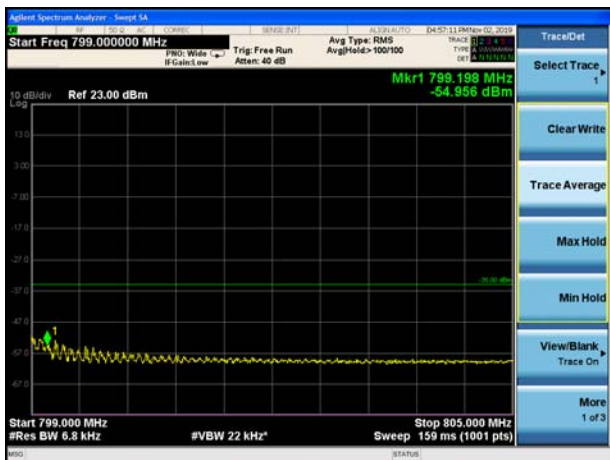

LTE Band 14 16QAM 10MHz 100%RB
(799MHz ~805MHz)

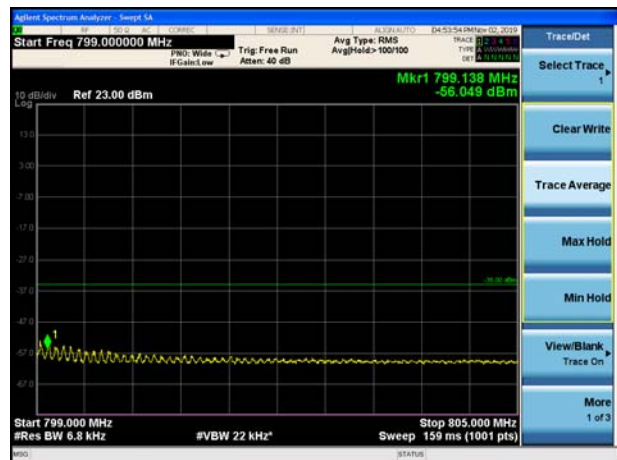

5.4. Peak-to-Average Power Ratio (PAPR)

Ambient condition

Temperature	Relative humidity	Pressure
23°C ~25°C	45%~50%	101.5kPa

Methods of Measurement

Measure the total peak power and record as PPK. And measure the total average power and record as PAvg. Both the peak and average power levels must be expressed in the same logarithmic units (e.g., dBm). Determine the PAPR from:

$$PAPR (dB) = PPK (dBm) - PAvg (dBm).$$

Test Setup

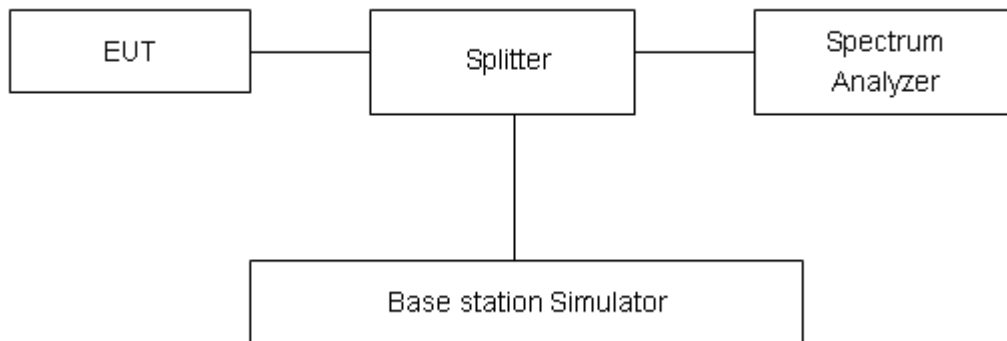

Limits

In measuring transmissions in this band using an average power technique, the peak-to-average ratio (PAR) of the transmission may not exceed 13 dB in 24.232(d).

Measurement Uncertainty

The assessed measurement uncertainty to ensure 95% confidence level for the normal distribution is with the coverage factor $k = 2$, $U = 0.4$ dB.

**Test Results**

Mode	Bandwidth	Modulation	Channel/ Frequency(MHz)	Peak-to-Average Power Ratio (PAPR)		
				Peak(dBm)	Avg(dBm)	PAPR(dB)
Band14	5MHz	QPSK	23330/793	24.87	15.02	9.85
		16QAM	23330/793	24.76	14.57	10.19
	10MHz	QPSK	23330/793	24.92	15.52	9.40
		16QAM	23330/793	25.33	16.10	9.23

5.5. Frequency Stability

Ambient condition

Temperature	Relative humidity	Pressure
23°C ~25°C	45%~50%	101.5kPa

Method of Measurement

1. Frequency Stability (Temperature Variation)

The temperature inside the climate chamber is varied from -40°C to +85°C in 10°C step size,

(1) With all power removed, the temperature was decreased to 0°C and permitted to stabilize for three hours.

(2) Measure the carrier frequency with the test equipment in a “call mode”. These measurements should be made within 1 minute of powering up the mobile station, to prevent significant self warming.

(3) Repeat the above measurements at 10°C increments from -40°C to +85°C. Allow at least 1.5 hours at each temperature, un-powered, before making measurements.

2. Frequency Stability (Voltage Variation)

The frequency stability shall be measured with variation of primary supply voltage as follows:

(1) Vary primary supply voltage from 85 to 115 percent of the nominal value for other than hand carried battery equipment.

(2) For hand carried, battery powered equipment, reduce primary supply voltage to the battery-operating end point which shall be specified by the manufacturer.

This transceiver is specified to operate with an input voltage of between 2.6 V and 4.8V, with a nominal voltage of 3.3V.

Test setup

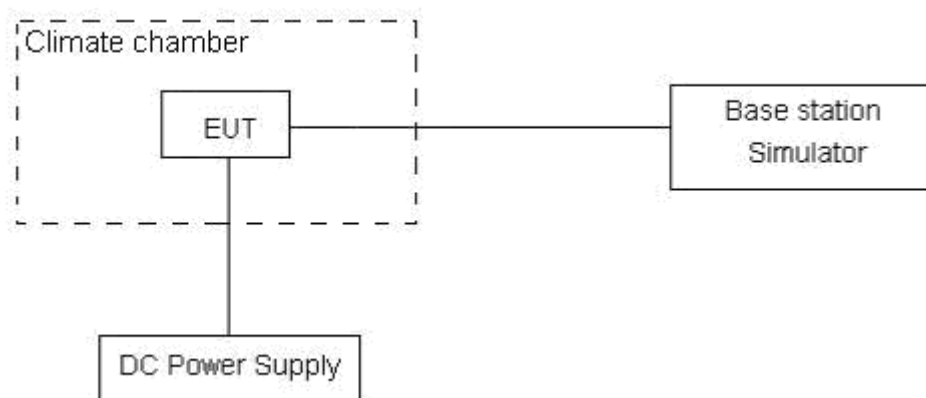

**Limits**

90.539 (c) The frequency stability of mobile, portable, and control transmitters operating in the narrowband segment must be 400 parts per billion or better when AFC is locked to the base station. When AFC is not locked to the base station, the frequency stability must be at least 1.0 ppm for 6.25 kHz, 1.5 ppm for 12.5 kHz (2 channel aggregate), and 2.5 ppm for 25 kHz (4 channel aggregate).

Measurement Uncertainty

The assessed measurement uncertainty to ensure 99.75% confidence level for the normal distribution is with the coverage factor $k = 3$, $U = 0.01\text{ppm}$.

Test Result

LTE Band 14						
Condition		Freq.Error (Hz)	Freq.Error (Hz)	Frequency Stability (ppm)	Frequency Stability (ppm)	Verdict
BANDWIDTH	10MHz	16QAM	QPSK	16QAM	QPSK	
Temperature	Voltage	16QAM	QPSK	16QAM	QPSK	
Normal (25°C)	Normal	11.90	7.03	0.00633	0.00374	PASS
Extreme (85°C)		17.44	5.25	0.00928	0.00279	PASS
Extreme (80°C)		6.43	7.65	0.00342	0.00407	PASS
Extreme (70°C)		2.88	11.65	0.00153	0.00620	PASS
Extreme (60°C)		11.88	11.48	0.00632	0.00611	PASS
Extreme (50°C)		16.39	2.41	0.00872	0.00128	PASS
Extreme (40°C)		12.99	15.33	0.00691	0.00815	PASS
Extreme (30°C)		12.66	16.04	0.00673	0.00853	PASS
Extreme (20°C)		17.06	17.83	0.00907	0.00948	PASS
Extreme (10°C)		2.96	17.66	0.00158	0.00939	PASS
Extreme (0°C)		7.93	16.56	0.00422	0.00881	PASS
Extreme (-10°C)		16.04	13.68	0.00853	0.00728	PASS
Extreme (-20°C)		13.02	15.10	0.00693	0.00803	PASS
Extreme (-30°C)		12.47	1.14	0.00663	0.00060	PASS
Extreme (-40°C)		4.15	15.79	0.00221	0.00840	PASS
25°C	LV	1.95	4.55	0.00104	0.00242	PASS
	HV	16.31	12.09	0.00868	0.00643	PASS

5.6. Spurious Emissions at Antenna Terminals

Ambient condition

Temperature	Relative humidity	Pressure
23°C ~25°C	45%~50%	101.5kPa

Method of Measurement

The EUT was connected to Spectrum Analyzer and Base Station Simulator via power Splitter. The measurement is carried out using a spectrum analyzer. The spectrum analyzer scans from 30MHz to the 10th harmonic of the carrier. The peak detector is used. Set RBW 1MHz and VBW 3MHz, Sweep is set to ATUO.

Of those disturbances below (limit – 20 dB), the mark is not required for the EUT.

Test setup

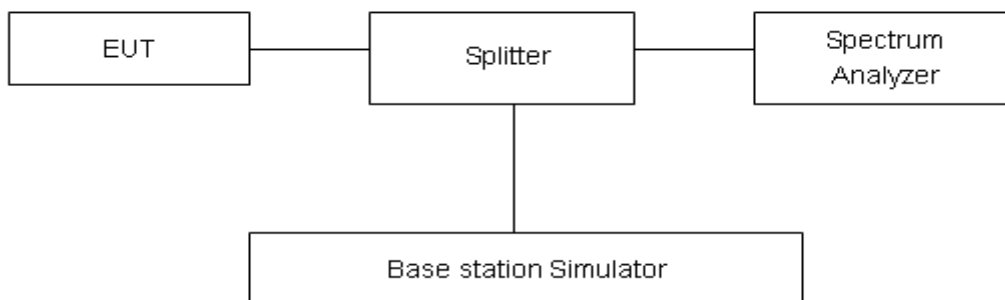

Limits

90.543 Emission limitations (e) For operations in the 758-768 MHz and the 788-798 MHz bands, the power of any emission outside the licensee's frequency band(s) of operation shall be attenuated below the transmitter power (P) within the licensed band(s) of operation, measured in watts, in accordance with the following:

- (1) On all frequencies between 769-775 MHz and 799-805 MHz, by a factor not less than $76 + 10 \log (P)$ dB in a 6.25 kHz band segment, for base and fixed stations.
- (2) On all frequencies between 769-775 MHz and 799-805 MHz, by a factor not less than $65 + 10 \log (P)$ dB in a 6.25 kHz band segment, for mobile and portable stations.
- (3) On any frequency between 775-788 MHz, above 805 MHz, and below 758 MHz, by at least $43 + 10 \log (P)$ dB.
- (4) Compliance with the provisions of paragraphs (e)(1) and (2) of this section is based on the use of measurement instrumentation such that the reading taken with any resolution bandwidth setting should be adjusted to indicate spectral energy in a 6.25 kHz segment.



(5) Compliance with the provisions of paragraph (e)(3) of this section is based on the use of measurement instrumentation employing a resolution bandwidth of 100 kHz or greater. However, in the 100 kHz bands immediately outside and adjacent to the frequency block, a resolution bandwidth of 30 kHz may be employed.

(f) For operations in the 758-775 MHz and 788-805 MHz bands, all emissions including harmonics in the band 1559-1610 MHz shall be limited to -70 dBW/MHz equivalent isotropically radiated power (EIRP) for wideband signals, and -80 dBW EIRP for discrete emissions of less than 700 Hz bandwidth. For the purpose of equipment authorization, a transmitter shall be tested with an antenna that is representative of the type that will be used with the equipment in normal operation.

Measurement Uncertainty

The assessed measurement uncertainty to ensure 99.75% confidence level for the normal distribution is with the coverage factor $k = 1.96$.

Frequency	Uncertainty
100kHz-1GHz	0.684 dB
1GHz-12.75GHz	1.407 dB

Test Result

If disturbances were found more than 20dB below limit line, the mark is not required for the EUT.
The signal beyond the limit is carrier.

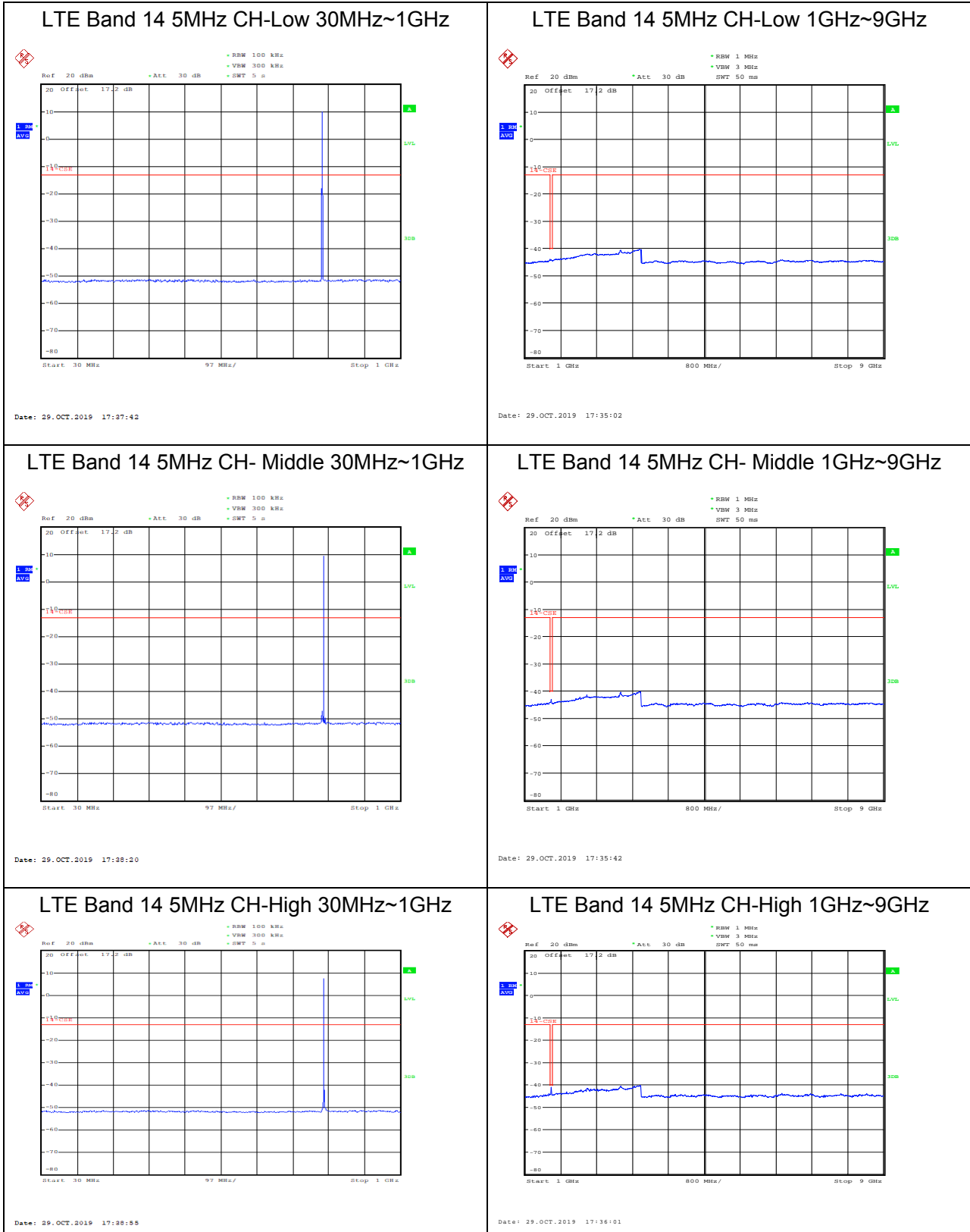



LTE Band 14 10MHz CH- Middle 30MHz~1GHz

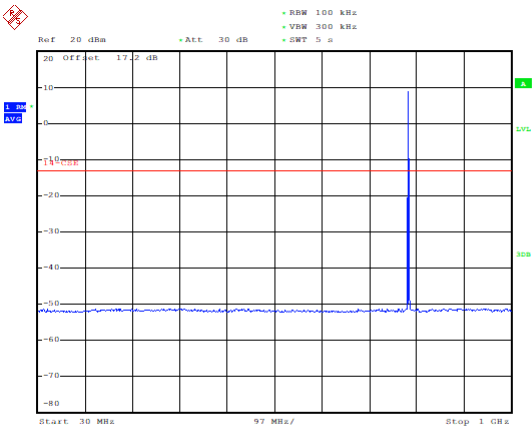

Date: 29.OCT.2019 17:36:51

LTE Band 14 10MHz CH- Middle 1GHz~9GHz

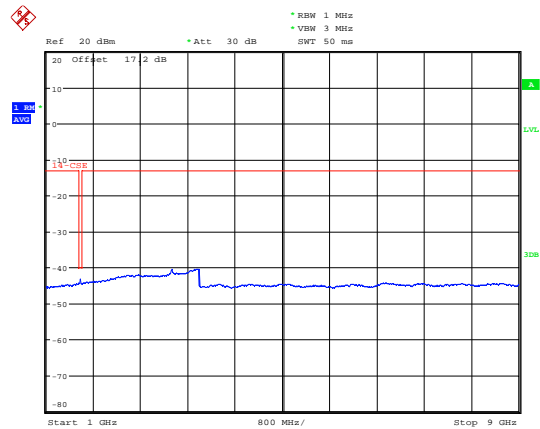

Date: 29.OCT.2019 17:36:24

5.7. Radiates Spurious Emission

Ambient condition

Temperature	Relative humidity	Pressure
23°C ~25°C	45%~50%	101.5kPa

Method of Measurement

1. The testing follows FCC KDB 971168 D01 v03r01 Section 5.8 and ANSI C63.26 (2015).
2. Above 30MHz: The EUT is placed on a turntable 0.8 meters above the ground in the chamber, 3 meter away from the antenna. The maximal emission value is acquired by adjusting the antenna height, polarisation and turntable azimuth. Normally, the height range of antenna is 1 m to 4 m, the azimuth range of turntable is 0° to 360° , and the receive antenna has two polarizations Vertical (V) and Horizontal (H). Above 1GHz: (Note: the FCC' s permission to use 1.5m as an alternative per TCBC Conf call of Dec. 2, 2014.) The EUT is placed on a turntable 1.5 meters above the ground in the chamber, 3 meter away from the antenna. The maximal emission value is acquired by adjusting the antenna height, polarisation and turntable azimuth. Normally, the height range of antenna is 1 m to 4 m, the azimuth range of turntable is 0° to 360° , and the receive antenna has two polarizations Vertical (V) and Horizontal (H).
3. A loop antenna, A log-periodic antenna or horn antenna shall be substituted in place of the EUT. The log-periodic antenna will be driven by a signal generator and the level will be adjusted till the same power value on the spectrum analyzer or receiver. The level of the spurious emissions can be calculated through the level of the signal generator, cable loss, the gain of the substitution antenna and the reading of the spectrum analyzer or receiver.
4. The EUT is then put into continuously transmitting mode at its maximum power level during the test. Set Test Receiver or Spectrum RBW=200Hz,VBW=600Hz for 9kHz150kHz , RBW=10kHz, VBW=30kHz 150kHz-30MHz , RBW=100kHz,VBW=300kHz for 30MHz to 1GHz and RBW=1MHz, VBW=3MHz for above 1GHz, And the maximum value of the receiver should be recorded as (Pr).
5. The EUT shall be replaced by a substitution antenna. In the chamber, an substitution antenna for the frequency band of interest is placed at the reference point of the chamber. An RF Signal source for the frequency band of interest is connected to the substitution antenna with a cable that has been constructed to not interfere with the radiation pattern of the antenna. A power (PMea) is applied to the input of the substitution antenna, and adjust the level of the signal generator output until the value of the receiver reach the previously recorded (Pr). The power of signal source (PMea) is recorded. The test should be performed by rotating the test item and adjusting the receiving antenna polarization.
6. A amplifier should be connected to the Signal Source output port. And the cable should be connect between the Amplifier and the Substitution Antenna. The cable loss (Pcl) ,the Substitution Antenna Gain (Ga) and the Amplifier Gain (PAg) should be recorded after test.
7. The measurement results are obtained as described below:
Power(EIRP)=PMea- PAg - Pcl + Ga
The measurement results are amend as described below:
Power(EIRP)=PMea- Pcl + Ga
8. This value is EIRP since the measurement is calibrated using an antenna of known gain (2.15 dBi)

and known input power. ERP can be calculated from EIRP by subtracting the gain of the dipole, $ERP = EIRP - 2.15\text{dBi}$.

The modulation mode and RB allocation refer to section 5.1, using the maximum output power configuration.

Test setup

9KHz ~ 30MHz

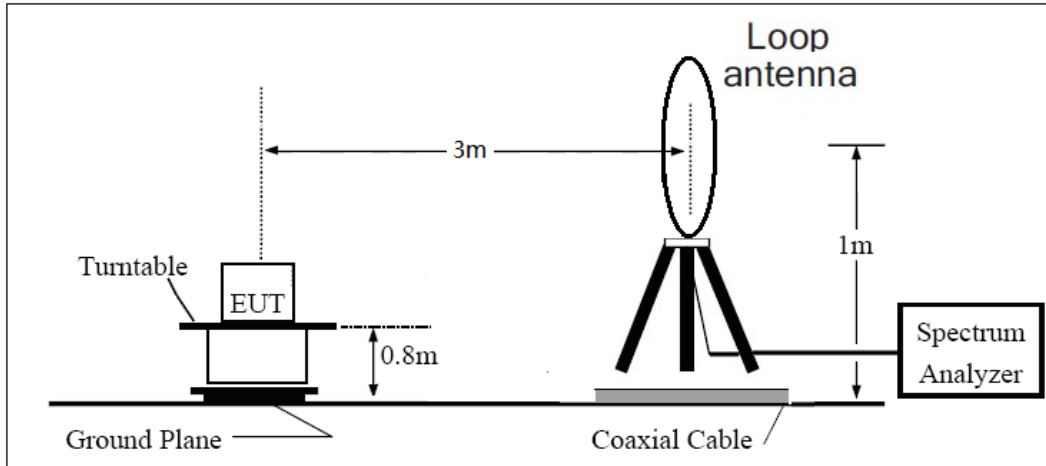

30MHz ~ 1GHz

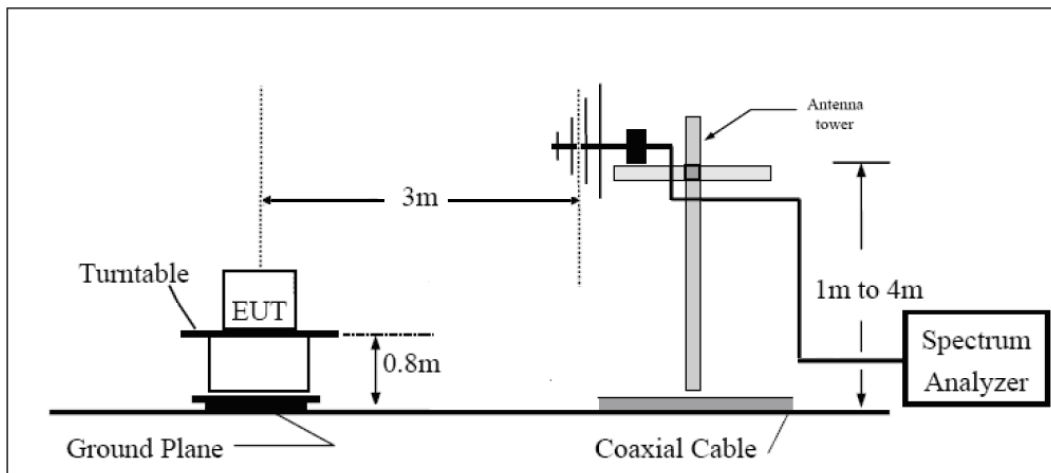

Above 1GHz

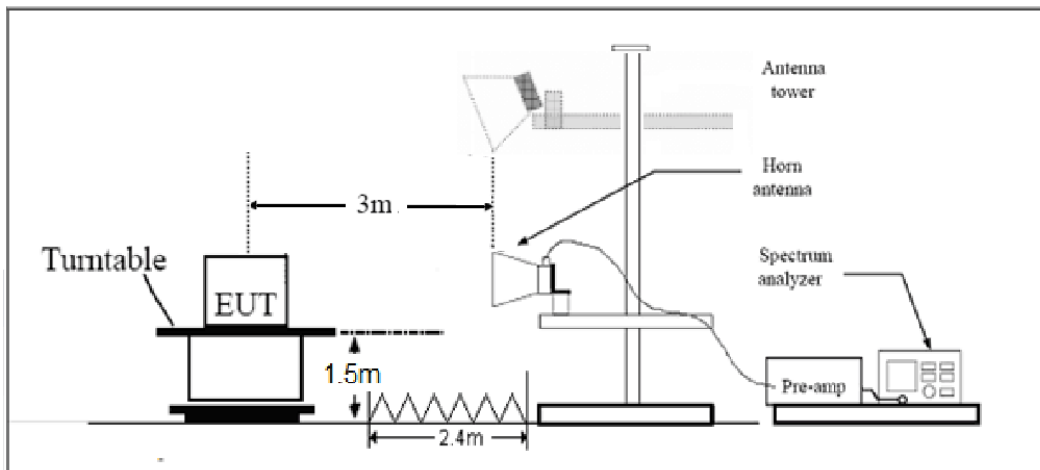

Note: Area side: 2.4mX3.6m

Limits

90.543 Emission limitations (e) For operations in the 758-768 MHz and the 788-798 MHz bands, the power of any emission outside the licensee's frequency band(s) of operation shall be attenuated below the transmitter power (P) within the licensed band(s) of operation, measured in watts, in accordance with the following:

(1) On all frequencies between 769-775 MHz and 799-805 MHz, by a factor not less than $76 + 10 \log (P)$ dB in a 6.25 kHz band segment, for base and fixed stations.

(2) On all frequencies between 769-775 MHz and 799-805 MHz, by a factor not less than $65 + 10 \log (P)$ dB in a 6.25 kHz band segment, for mobile and portable stations.

(3) On any frequency between 775-788 MHz, above 805 MHz, and below 758 MHz, by at least $43 + 10 \log (P)$ dB.

(4) Compliance with the provisions of paragraphs (e)(1) and (2) of this section is based on the use of measurement instrumentation such that the reading taken with any resolution bandwidth setting should be adjusted to indicate spectral energy in a 6.25 kHz segment.

(5) Compliance with the provisions of paragraph (e)(3) of this section is based on the use of measurement instrumentation employing a resolution bandwidth of 100 kHz or greater. However, in the 100 kHz bands immediately outside and adjacent to the frequency block, a resolution bandwidth of 30 kHz may be employed.

(f) For operations in the 758-775 MHz and 788-805 MHz bands, all emissions including harmonics in the band 1559-1610 MHz shall be limited to -70 dBW/MHz equivalent isotropically radiated power (EIRP) for wideband signals, and -80 dBW EIRP for discrete emissions of less than 700 Hz bandwidth. For the purpose of equipment authorization, a transmitter shall be tested with an antenna that is representative of the type that will be used with the equipment in normal operation.

Measurement Uncertainty

The assessed measurement uncertainty to ensure 95% confidence level for the normal distribution is with the coverage factor $k = 1.96$, $U = 3.55$ dB.

**Test Result**

Sweep the whole frequency band through the range from 9kHz to the 10th harmonic of the carrier, the emissions below the noise floor will not be recorded in the report.

LTE Band 14 QPSK 5MHz CH-Middle, RB 1

Harmonic	Frequency (MHz)	SG (dBm)	Cable Loss (dB)	Gain (dBi)	Antenna Polarization	ERP Level (dBm)	Limit (dBm)	Margin (dB)	Azimuth (deg)
2	1581.6	-51.04	2.00	10.75	Horizontal	-44.44	-13.00	31.44	135
3	2379.0	-44.17	2.51	11.05	Horizontal	-37.78	-13.00	24.78	45
4	3172.0	-51.65	4.20	11.15	Horizontal	-46.85	-13.00	33.85	125
5	3965.0	-60.28	5.20	11.15	Horizontal	-56.48	-13.00	43.48	180
6	4758.0	-59.81	5.50	11.95	Horizontal	-55.51	-13.00	42.51	90
7	5551.0	-61.31	5.70	13.55	Horizontal	-55.61	-13.00	42.61	0
8	6344.0	-58.31	6.30	13.75	Horizontal	-53.01	-13.00	40.01	315
9	7137.0	-53.95	6.80	13.85	Horizontal	-49.05	-13.00	36.05	45
10	7930.0	-54.26	6.90	14.25	Horizontal	-49.06	-13.00	36.06	315

Note: 1.The other Spurious RF Radiated emissions level is no more than noise floor.

2. The worst emission was found in the antenna is Horizontal position.

LTE Band 14 QPSK 10MHz CH-Middle, RB 1

Harmonic	Frequency (MHz)	SG (dBm)	Cable Loss (dB)	Gain (dBi)	Antenna Polarization	ERP Level (dBm)	Limit (dBm)	Margin (dB)	Azimuth (deg)
2	1577.1	-53.53	2.00	10.75	Horizontal	-46.93	-40.00	6.93	180
3	2378.4	-43.93	2.51	11.05	Horizontal	-37.54	-13.00	24.54	225
4	3172.0	-50.10	4.20	11.15	Horizontal	-45.30	-13.00	32.30	315
5	3965.0	-59.20	5.20	11.15	Horizontal	-55.40	-13.00	42.40	45
6	4758.0	-60.00	5.50	11.95	Horizontal	-55.70	-13.00	42.70	0
7	5551.0	-61.50	5.70	13.55	Horizontal	-55.80	-13.00	42.80	90
8	6344.0	-58.30	6.30	13.75	Horizontal	-53.00	-13.00	40.00	45
9	7137.0	-54.40	6.80	13.85	Horizontal	-49.50	-13.00	36.50	315
10	7930.0	-52.60	6.90	14.25	Horizontal	-47.40	-13.00	34.40	135

Note: 1.The other Spurious RF Radiated emissions level is no more than noise floor.

2. The worst emission was found in the antenna is Horizontal position.



6. Main Test Instruments

Name	Manufacturer	Type	Serial Number	Calibration Date	Expiration Date
Base Station Simulator	R&S	CMW500	113645	2019-05-19	2020-05-18
Power Splitter	Hua Xiang	SHX-GF2-2-13	10120101	/	/
Spectrum Analyzer	Agilent	N9010A	MY50210259	2019-05-19	2020-05-18
Universal Radio Communication Tester	Agilent	E5515C	MY48367192	2019-05-19	2020-05-18
Signal Analyzer	R&S	FSV40	15195-01-00	2019-05-19	2020-05-18
Trilog Antenna	SCHWARZBECK	VUBL 9163	9163-201	2017-11-18	2020-11-17
Horn Antenna	R&S	HF907	100126	2018-07-07	2020-07-06
Signal generator	R&S	SMB 100A	102594	2019-05-19	2020-05-18
Climatic Chamber	ESPEC	SU-242	93000506	2017-12-17	2020-12-16
RF Cable	Agilent	SMA 15cm	0001	2019-12-13	2020-6-12
Software	R&S	EMC32	9.26.0	/	/

*****END OF REPORT *****