

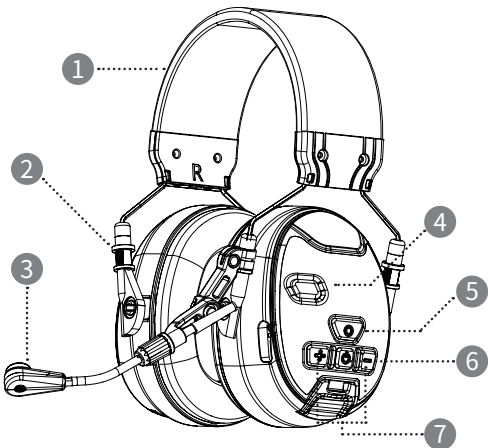

**C51**

Thanks for your choosing EARMOR®  
EARMOR® Hearing Protectors designed to protect users from harmful noise.

## PARTS



- |                      |                   |
|----------------------|-------------------|
| 1. Headband          | 5. Bluetooth Mode |
| 2. Slider            | 6. ON/ OFF        |
| 3. Microphone        | 7. Volume buttons |
| 4. Microphone Pickup |                   |

## APPROVED

EARMOR® C51 electronic Hearing Protector are tested and certified according to the following standards:

ANSI S3.19-1974

EN 352-1 : 2020

EN 352-6 : 2020

Noise Reduction Rating - 24dB

EARMOR® C51 Attenuation data, American National Standards Institute specifications ANSI S3.19-1974

TEST FREQ.(HZ)	125	250	500	1000	2000	3150	4000	6300	8000	NRR
MEAN ATTENUATION (DB)	12.3	24.7	37.3	35.7	35.2	40.5	34.8	27.0	13.9	26
STANDARD DEVEATION(DB)	1.1	0.3	1.0	1.7	3.1	2.4	4.4	2.8	1.3	

## DESCRIPTION

EARMOR® C51 electronic noise reduction headsets can provide hearing protection in noisy environments, and can sense the environment through the sound pickup function. With the Bluetooth function, you can connect to Bluetooth devices for telephone communication, send voice messages or listen to music during work. Suitable for many industries: oil and gas industry, mining industry, automobile manufacturing, building construction, design, food and beverage manufacturing, forestry, industrial maintenance, metal manufacturing, military maintenance, equipment maintenance, pharmaceuticals, racing, transportation.

## INFORMATIONS

For the best protection, ear cushion sealing ring should seal firmly against head, Anything that interferes with the seal --- such as long hair(pull back to the extent possible), thick or poorly fitting eyeglass temples, pencils or caps will lessen the protection.

- Earmuffs must be regularly inspected for cracks or worn parts and replaced as needed. Typical life for foam cushion sealing rings is 12 months.
- Clean the exterior of the hearing protector regularly with soap and warm water. Do not immerse the whole headset in water.
- Do not store the hearing protector behind a windshield or at temperatures above 131°F(55°C).
- Certain chemical substances may damage this product. Contact the manufacturer for more information.

## CAUTION

If instructions are not followed, bodily injury may result or protection may be severely reduced. These hearing protectors help reduce exposure to hazardous noise and other loud sounds. Misuse or failure to wear hearing protectors at all times when you are exposed to noise may result in hearing loss or injury.

If there is any drainage from your ear or if you have an ear infection, consult with your physician before wearing hearing protection. Failure to do so may result in hearing loss or injury.

For proper use, see user instructions or contact EARMOR customer service Email: [csf@opsmen.com](mailto:csf@opsmen.com)

## TO REDUCE THE SAFETY RISK WHEN USING THE PRODUCT

- Only use the specified type of battery provided by OPSMEN.
- When using lithium ion batteries, there is a risk of fire and burning. Do not open, squeeze, heat above 50°C (122°F) or incinerate.
- If there is any damage or malfunction of the headset or accessories, stop using it.
- Contact OPSMEN official after-sales mailbox [CSF@OPSMEN.COM](mailto:CSF@OPSMEN.COM) for maintenance service.

## TO REDUCE THE SAFETY RISK WHEN USING THE PRODUCT

- Only use the specified type of battery provided by OPSMEN.
- When using lithium ion batteries, there is a risk of fire and burning. Do not open, squeeze, heat above 50°C (122°F) or incinerate.
- If there is any damage or malfunction of the headset or accessories, stop using it.
- Contact OPSMEN official after-sales mailbox [CSF@OPSMEN.COM](mailto:CSF@OPSMEN.COM) for maintenance service.

## NOISE REDUCTION MODE

1. Press and hold  two seconds to turn on the device for two seconds and enter the noise reduction mode when you hear "Ambient listening Mode".

\*After power on, the volume is the volume used last time.

2. Press  Increase the ambient volume, keep pressing the volume will increase to the maximum.

Press  Reduce the ambient volume, keep pressing the volume will reduce to mute.

\* Total of 5 levels of ambient volume to adjust.

3. Press and hold  for two second to turn off, you will hear "power off".

## EN 352 SAFETY INFORMATION :

- The output of the level-dependent circuit of the hearing protector may exceed the external sound level.
- Installing the sanitary cover on the cushion may affect the acoustic performance of the earmuffs.
- Performance will decrease with battery consumption. The expected continuous use time of the battery is approximately 8-13 hours.
- Maybe adversely affected by certain chemical substances. More information can be get from the manufacturer.



This product contains electrical and electronic components and must not be disposed of using standard garbage collection. Please consult your local electrical and electronic equipment disposal instructions.

## TO REDUCE THE RISKS ASSOCIATED WITH HARMFUL NOISE

- Listening to music or audio communication may reduce situational awareness and the ability to hear warning signals. Stay alert and adjust the volume to the lowest acceptable level.
- Use and maintain the hearing protector properly. Check the hearing protector before each use. If it is damaged, please choose an undamaged hearing protector or avoid a noisy environment.
- Do not bend or reshape the headband, and ensure that there is enough clamping force to fix the earmuffs
- Earmuffs must be regularly inspected for cracks and leaks to be worn properly, replaced as needed.
- The output of the electronic audio circuit of this hearing protector may exceed the daily limit sound level. Please adjust the audio volume to the lowest acceptable level

## BLUETOOTH MODE



1. Press and hold  for two seconds after turn on, you will hear "Bluetooth mode", and LED will blink blue light is Bluetooth mode.



2. After switching the mode, the indicator light flashes in red and blue to be a connectable mode, and the prompt sound when the device is paired is "Bluetooth mode, Pairing On", this device is C51, After the selected device is successfully paired, you will hear "connected".

\*If the device is not connected to the mobile phone for more than five minutes, it will automatically exit the Bluetooth mode and hear "Ambient listening Mode".

3. After entering the Bluetooth "  " mode, the sound pickup and noise reduction effect will still be retained, press buttons to adjust the ambient volume.

\*The volume of the Bluetooth needs to be adjusted by the mobile phone, and the C51 adjustment is only for the sound effect of pickup and noise reduction

4. Click the button  to answer when a call comes in, long press the  button for 2 seconds to reject the call, and click the button  to hang up during a call.

5. Click the button  to play the music in the connected state, and then click the music to  pause.

6. Press and hold  for two seconds, you will hear "Ambient listening Mode", Exit the Bluetooth mode and enter the noise reduction mode.

\*In Bluetooth mode, the microphone can be used to make calls or send voice messages.

## CHARGING INSTRUCTION

\* Connect the TYPE-C interface through the charging cable for charging. When the headset is in the charging state, the indicator light is red; and when the headset is fully charged, it is green.

\*Do not open the battery compartment or replace the battery by yourself

\* Low Battery Warning

## FCC WARNING

This device complies with part 15 of the FCC Rules. Operation is subject to the following two conditions: (1) This device may not cause harmful interference, and (2) this device must accept any interference received, including interference that may cause undesired operation.

**Note:** This equipment has been tested and found to comply with the limits for a Class B digital device, pursuant to part 15 of the FCC Rules. These limits are designed to provide reasonable protection against harmful interference in a residential installation. This equipment generates, uses and can radiate radio frequency energy and, if not installed and used in accordance with the instructions, may cause harmful interference to radio communications. However, there is no guarantee that interference will not occur in a particular installation. If this equipment does cause harmful interference to radio or television reception, which can be determined by turning the equipment off and on, the user is encouraged to try to correct the interference by one or more of the following measures:

- Reorient or relocate the receiving antenna.
- Increase the separation between the equipment and receiver.
- Connect the equipment into an outlet on a circuit different from that to which the receiver is connected.
- Consult the dealer or an experienced radio/TV technician for help.

**Note:** The Grantee is not responsible for any changes or modifications not expressly approved by the party responsible for compliance. such modifications could void the user's authority to operate the equipment.

The device has been evaluated to meet general RF exposure requirement. This equipment complies with FCC's RF radiation exposure limits set forth for an uncontrolled environment. This device and its antenna(s) must not be co-located or conjunction with any other antenna or transmitter.

## SPECIFICATIONS:

Life time: 32 hours

Battery capacity: 800mAh

Charging current: 280mA

Use current: 15mA (70% volume Bluetooth music playback operating current)

Working temperature: -20 C° to 50C°

Storage temperature (full set): -20C° to 50 C°

Charging temperature: 0 C° to 50 C°

Protection level: IP42

## AUDIO INPUT LEVEL

The audio level in the hearing protector is dependent on the audio input level.

To prevent harmful noise levels, the hearing protector audio levels is limited to 82dB when connected to a Personal Music Player (PMP). If the hearing protector is connected to a PMP or other device with very high output level ,it is the user's responsibility to set the audio input level to a safe level.

## WARRANTY

EARMOR® C51 hearing protector is warranted to be free of defects in material and workmanship for a period of 1 year from the date of original purchase.

The warranty is nullified in all of the following situations:

1. The product(s) is/are broken down, reconstructed and/or modified by unauthorized parties.
2. The product(s) is/are damaged through improper use.
3. The product(s) is/are damaged by leakage of batteries.

## CONTACT

For the latest information on OPSMEN/EARMOR products and services

Please contact a local distributor or email OPSMEN distributor : [info@opsmen.com](mailto:info@opsmen.com) / [cs@opsmen.com](mailto:cs@opsmen.com)

OPSMEN official website <http://www.opsmen.com/> shall prevail in case of any product data changes.