



HUIPANG SPORTS

S-1001 Using manual



HUIPANG Lights Up Your Games

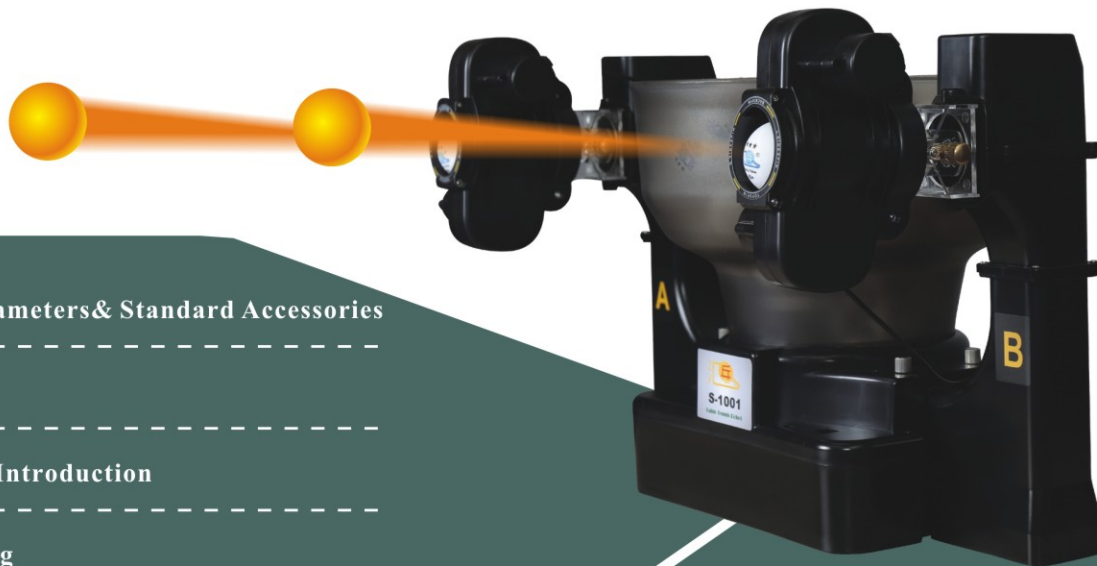

P2 Technical Parameters& Standard Accessories

P3 Installation

P4-P11 Function Introduction

P12 Fault Handling

P13 Special attention

P14 Parts Replacement

Catalog

Technical Parameters

G.W :5.1KG

N.W: 4 KG

Packing Dimensions : 41 * 36* 32CM

Rated Voltage :100-240V

Rated Power :36W

Spin: Topspin , Backspin , non-spin , left and right sidespin

Serving Frequency :32-80/Min

Serving Speed 4-40m/s

Minimum Ball Capacity: 120 balls

Maximum Ball Capacity : 10 balls

Point of fall : Random

Colors : Black

Can serve 9 spin balls and 1 non-spin ball

Can be up and down to adjust the radian

Can be left and right to adjust the spin ball

Can serve different spin balls and long short balls

Standard Accessories

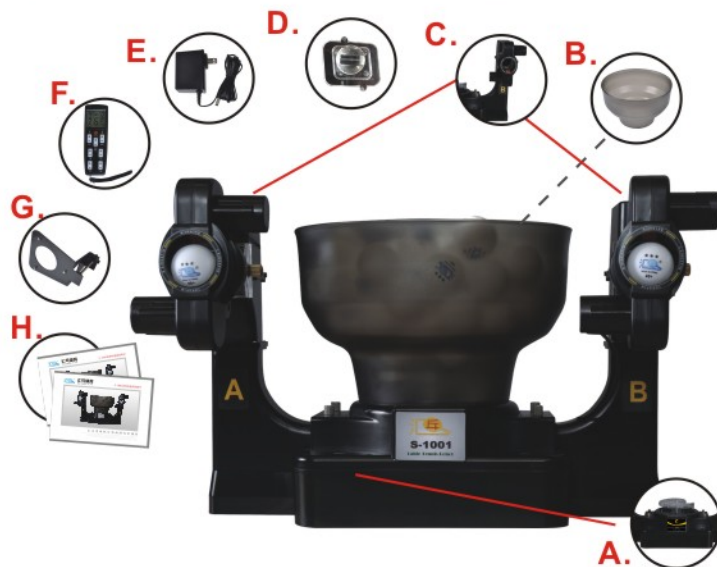

A · Main engine

B · Ball storage bucket

C · Robot heads(A & B)

D · Ball cover

E · Power

F · Remote control

G · Iron support

H · Using manual

Installation



①Unpack and check the accessories



②Connect the robot head A and B to the main engine



③Fix the ball storage bucket to the main engine and rotate to fix it.



④Connect the USB line of robot head A to the port of the main engine.



⑤Connect the USB line of robot head B to the port of the main engine.



⑥Link the power line .

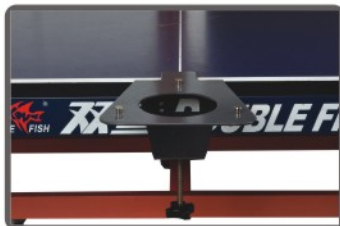

⑦Install the iron support



⑧Finish.

Note : Make sure to link well or the machine can't work correctly.

Function Introduction

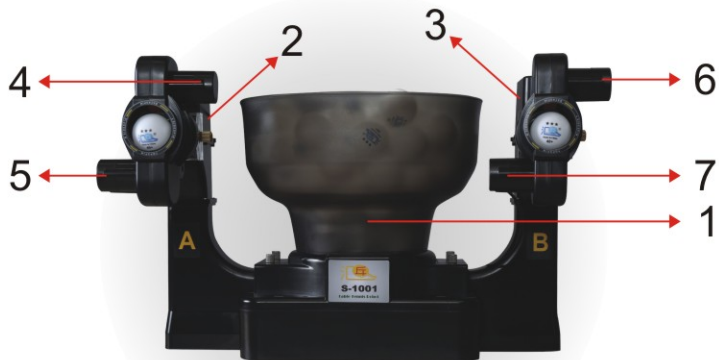

1. Ball serving frequency

2. Swing frequency of Fairway A

4. Topspin speed of Fairway A

5. Underspin speed of Fairway A

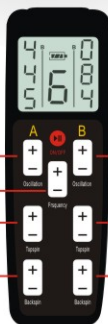

3. Swing frequency of Fairway B

6. Topspin speed of Fairway B

7. Underspin speed of Fairway B

Turn them up, the balls can hit wider area



控制上旋轮转速



Turn them up, the speed of topspin ball can get stronger.

控制下旋轮转速



Turn them up, the speed of underspin ball can get stronger.

Function Introduction

Remote control instruction

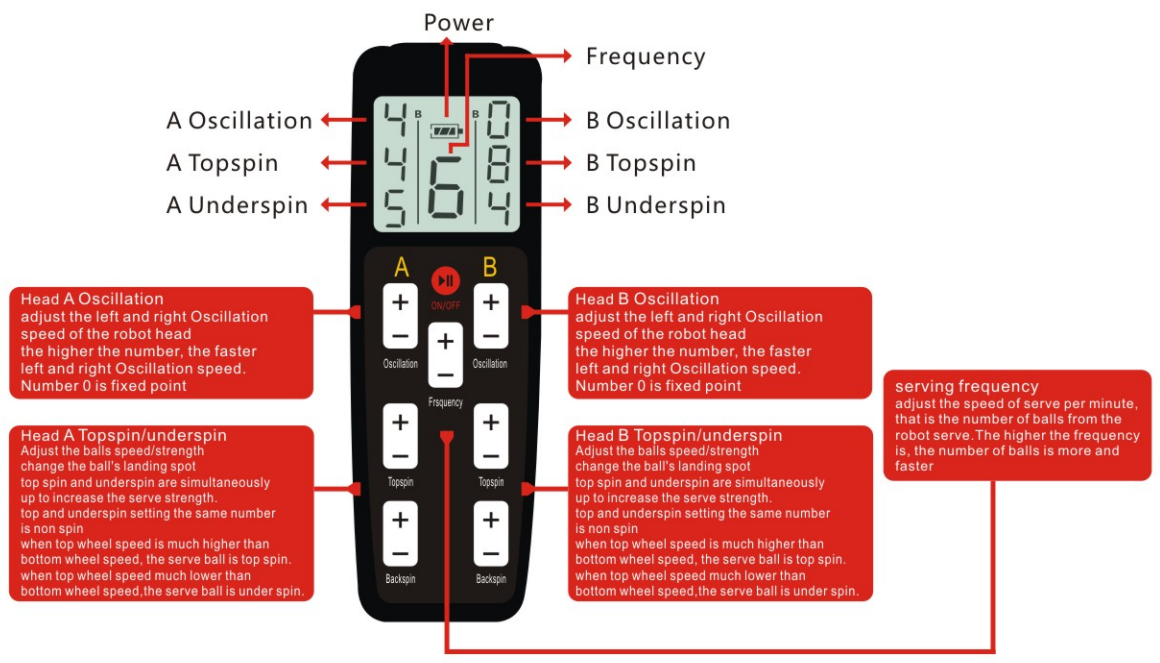

Function Introduction

Oscillation range

Tips: When the oscillation speed is zero , it is designated to serve.
When it works with the adjusting rod , it is random.

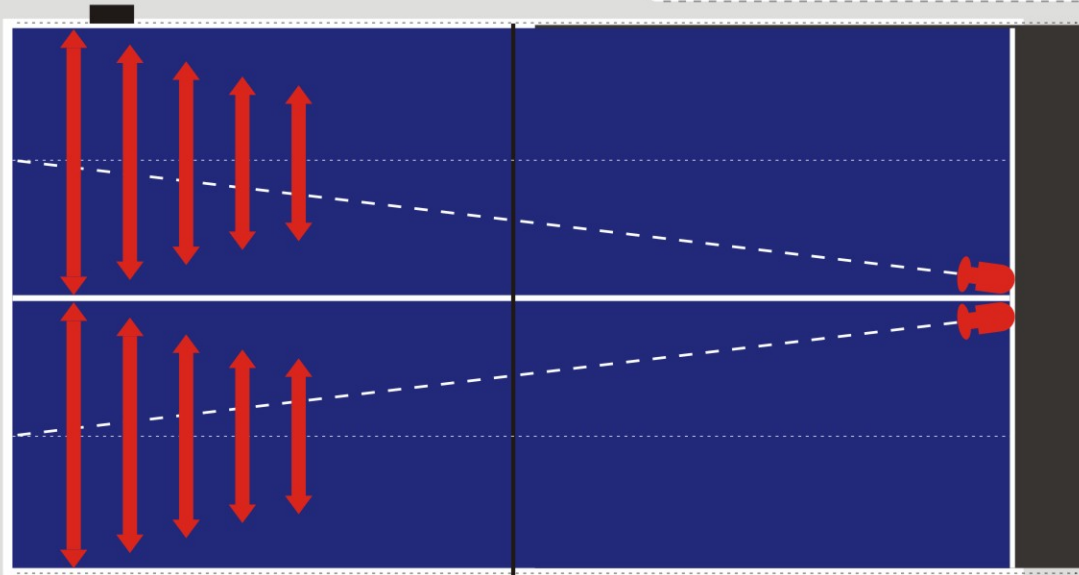

Serve point range diagram

Robot head A&B can be adjusted separately.

Function Introduction

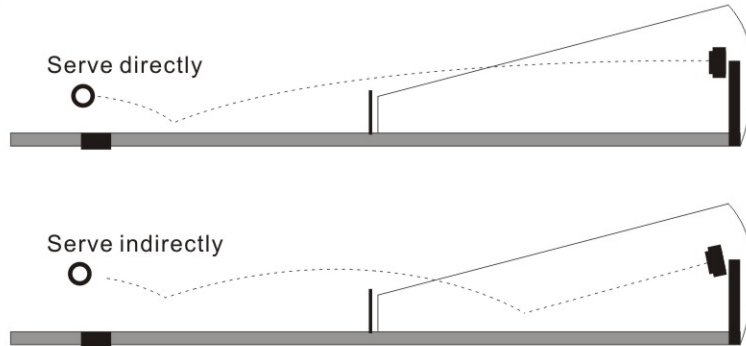

Serve Type Diagram

Serve type: Can serve ball directly and indirectly

Indirectly type : With a proper speed and spin ,it is much more suitable for beginners to practice different skills of serving and receiving balls.

Directly type : Compare with indirectly type ,it is stronger on its speed and spin. At a proper speed and spin ,it can give loop , smash ,lob etc.

It is suitable for daily practice.

Function Introduction

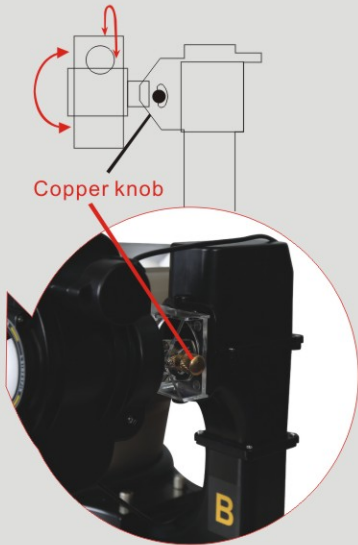

Must loosen the copper knob when you adjust the elevation of robot head. No adjustment when it is working .



Adjusting the speed of top-wheels & bottom-wheels and the direction of the robot heads can rotate the robot. Robot can serve 9 spin balls and 1 non-spin. The head can oscillate between 180 angles (horizontal line).

- 1 Position: The rotation of top-wheel is top spin, of the bottom-wheel is the under spin. With the same position is non-spin.
 - 2. Position: The rotation of top-wheel is left spin, of the bottom-wheel is the right spin. With the same position is non-spin.
 - 3. Position: The rotation of top-wheel is right spin, of the bottom-wheel is the left spin. With the same position is non-spin.
- Adjust two wheels and speed between 1 to 2 or among 1 to 3 ,can combine different kinds of spins.

Function Introduction



Put the ball cover on the ball mouth A or B



If the ball mouth B is covered, the ball mouth A is serving.



Function Introduction

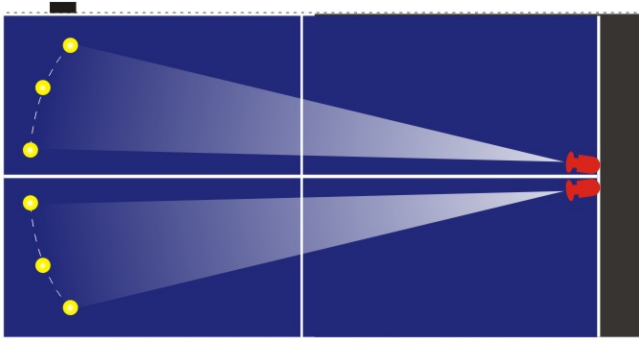

Random : Robot head A and B are oscillation.

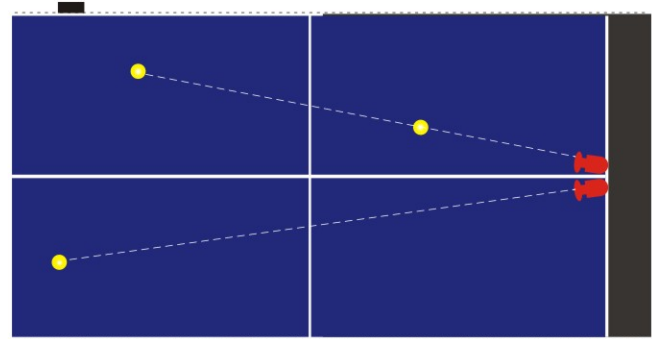

Backhand two jump ,Forehand one-point : Robot head A and B are not oscillation.

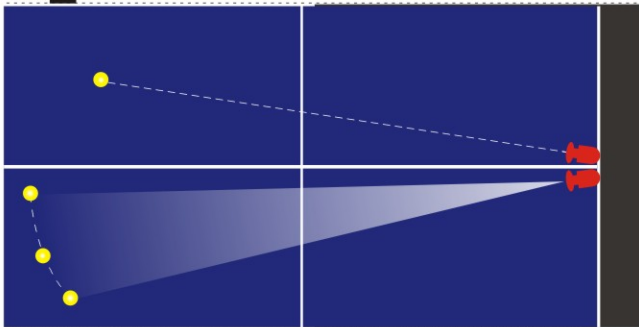

Backhand one -point , Forehand different points: Robot head A are not oscillation and B is oscillation.

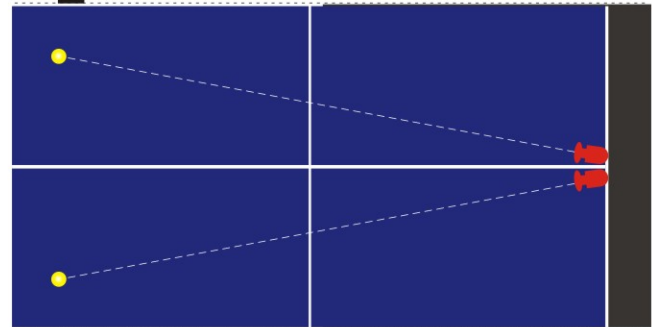

Two points practice , top-spin and under-spin can be set.

Function Introduction

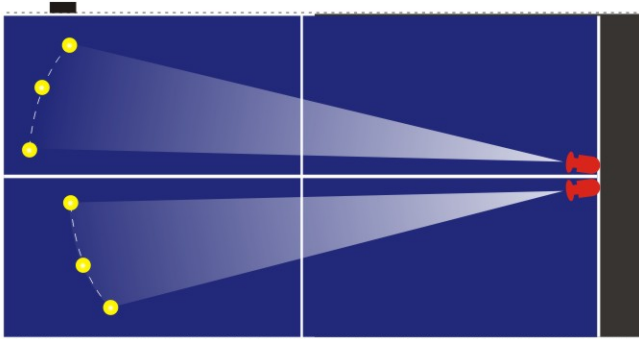

Random : Robot head A and B are oscillation.

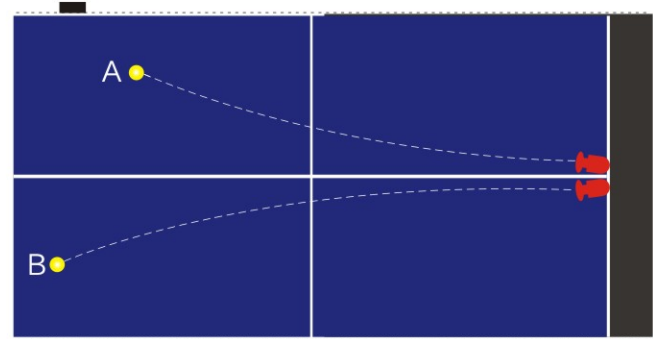

Point A is left sidespin ,Point B is right sidespin. Spin can be set.

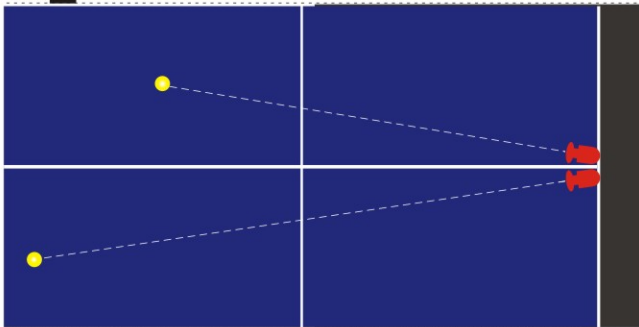

Two points long short balls practice: Robot head A and B are not oscillation. (The top-spin and under-spin of both robot heads can be set)

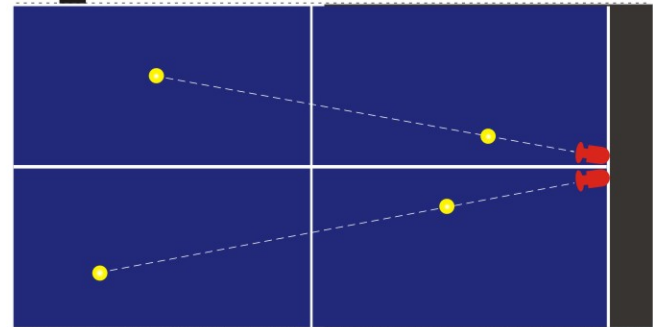

Two points and two jump ball, top-spin and under-spin can be set.

Fault Handing

Fault phenomenon	Failure cause	Treating method
Power with no reation	Power failure	Replace power supply
	Connection is not good	Replug power cord
Balls are not out	Ball groove is dirty	Take down the robot head ,then clean the ball groove and balls
	Balls are broken,dirty or not standard	Change to standard 40mm new balls
	Motor is broken	Replace
	Speed changing box is broken	Replace
Serve ball weakly	Motor for serving ball is broken	Replace
	Connection of power socket is not good	Replug
	Line of the motor is disconnected	Replug
No oscillation	Motor of oscillation is broken	Replace
	Speed changing box is broken	Replace
	Connection of power socket is not good	Replug
	Line of the motor is disconnected	Replug



When the balls are not out, please take down that robot head if you can distinguish. If you can't, you have to take down two robot heads, then clean the ball groove and the balls.

Notes

Warning:

- 1.Children must use the robot correctly by the guide of adults or parents.
- 2.Use the standard 40 mm balls. You can choose HUIPANG, DHS, Double Fish training balls or other more than one star balls. Please don't use the balls that are too soft or irregular to avoid clamping balls.
- 3.Clean the ball groove regularly to avoid clamping balls.(Because the force of friction of the ball groove will increase by using it)**
- 4.Clean the new balls with clear water or cleaning agent and dry them before you use them. And clean the balls and the ball groove termly to keep the machine clean and reduce the failure.
5. Add the balls to the storage tube when the machine is off to avoid clamping balls.
- 6.If you don't use the robot in a long time ,please clean it up and with good storage bags.
7. If you have any problems ,please contact our after-sale service.

Exchange accessory

Please use robot in clean environment, clean the dust and wash the balls in a certain time.



In the case the driving wheel is not working and not deliver balls, after troubleshooting, might you need to exchange the motor; in the case that the driving wheel is demanged or out of shape, might you need to exchange the driving wheel.

A . Exchange Driving Wheel

①Check which driving wheel is demanged.



②Disassemble 4 screws from side board.



③Disassemble the screw from the driving wheel, take out the demanged wheel.



④Take a new wheel, and put it inside follow the process before.

FCC Caution:

This device complies with part 15 of the FCC Rules. Operation is subject to the following two conditions: (1) this device may not cause harmful interference, and (2) this device must accept any interference received, including interference that may cause undesired operation.

Any changes or modifications not expressly approved by the party responsible for compliance could void the user's authority to operate the equipment.

NOTE: This equipment has been tested and found to comply with the limits for a Class B digital device, pursuant to Part 15 of the FCC Rules. These limits are designed to provide reasonable protection against harmful interference in a residential installation. This equipment generates, uses and can radiate radio frequency energy and, if not installed and used in accordance with the instructions, may cause harmful interference to radio communications. However, there is no guarantee that interference will not occur in a particular installation.

If this equipment does cause harmful interference to radio or television reception, which can be determined by turning the equipment off and on, the user is encouraged to try to correct the interference by one or more of the following measures:

- Reorient or relocate the receiving antenna.
- Increase the separation between the equipment and receiver.
- Connect the equipment into an outlet on a circuit different from that to which the receiver is connected.
- Consult the dealer or an experienced radio/TV technician for help.

From "To maintain compliance with FCC's RF Exposure guidelines, this equipment should be installed and operated with minimum distance between 0cm the radiator your body: Use only the supplied antenna." To: "This equipment has been evaluated to meet the FCC general RF exposure requirement. The device can be used in portable exposure condition without restriction."

FCC ID: 2A4HT-S1001



HUIPANG SPORTING EQUIPMENT Co.,LTD

Address: NO.169 Jinxing street,Guihu town,Chaozhou,GD province

Phone:+86-768-6754188

Email:huipang22@126.com

Web:www.huipang.net