

DEWALT®



**Instruction Manual
Guide D'utilisation
Manual de instrucciones**

TWO-WAY RADIO MODEL

DXFRS800

Owner's Manual

Definitions: Safety Alert Symbols and Words

This instruction manual uses the following safety alert symbols and words to alert you to hazardous situations and your risk of personal injury or property damage.

⚠ DANGER: Indicates an imminently hazardous situation which, if not avoided, **will** result in **death or serious injury**.

⚠ WARNING: Indicates a potentially hazardous situation which, if not avoided, **could** result in **death or serious injury**.

⚠ CAUTION: Indicates a potentially hazardous situation which, if not avoided, **may** result in **minor or moderate injury**.

⚠ (Used without word) Indicates a safety related message.

NOTICE: Indicates a practice **not related to personal injury** which, if not avoided, **may** result in **property damage**.

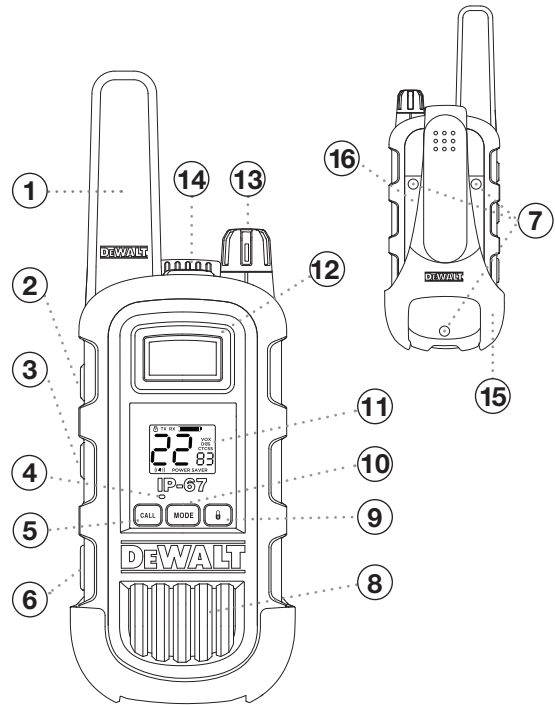

- | | |
|------------------------|---|
| 1. Antenna | 9. Lock Button |
| 2. Up Button | 10. Mode Button |
| 3. Down Button | 11. Backlit LCD Display |
| 4. Microphone | 12. Talk Button |
| 5. Call Button | 13. Power On/Off/Volume Knob |
| 6. USB Charge Jack | 14. External Speaker /
Microphone Jack |
| 7. Battery Door Screws | 15. Holster with Swivel Clip |
| 8. Speaker | 16. Battery Compartment |

Backlit LCD Display

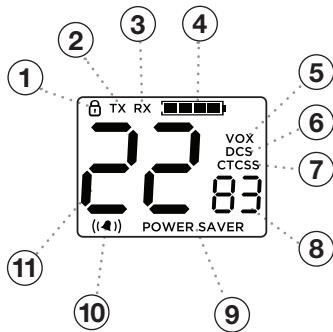

Features

- 22 Channels
 - 121 Privacy Codes
(38 CTCSS codes/
83 DCS codes)
 - IP67 Water Proof and
Dust Proof Rating
 - Hands-Free Operation
(VOX)
 - Backlit LCD Display
 - Call Alert
 - Button Lock
 - Speaker/ Microphone/
Charge Jack
 - Roger Beep
 - Battery/Power Saver
 - Keystroke Tones
 - Battery Level
Indicator
 - Low Battery
Audible Alert
 - Auto Squelch
 - Holster
1. Lock Icon
 2. Transmit Icon
 3. Receive Icon
 4. Battery Level Indicator
 5. VOX Icon
 6. DCS Icon
 7. CTCSS Icon
 8. DCS / CTCSS Privacy
Code Numbers
 9. Power Saver Icon
 10. Vibration Alert Icon
 11. Channel Numbers

Important Safety Instructions

⚠ WARNING: To reduce risk of injury:

Before any use, be sure everyone using this unit reads and understands all safety instructions and other information contained in this manual. Save these instructions and review frequently.

1. Only accessories included in this package or specified by the manufacturer should be used with the radio. The 5V USB-C charging input is compatible with most high quality USB-C chargers that fully conform to the USB standards.
2. Do not use cleaners or solvents to clean the exterior of the radio. Use only a damp or dry cloth.
3. Do not expose this product to splashing or dripping water.
4. Do not attempt to service the receiver yourself. Removing the cover will void the warranty. Changes or modifications not expressly approved by DEWALT may void the user's authority granted by the FCC to operate this device and should not be made.
5. Do not plug the wall adaptor into the power outlet if the outlet is wet.
6. Do not use any portable radio that has a damaged antenna. If a damaged antenna comes into contact with your skin, a minor burn can result.

Important Safety Instructions for Battery

⚠ WARNING: Read all safety warnings and all instructions:

Failure to follow the warnings and instructions may result in fire and/or serious injury

- Do not incinerate the battery even if it is severely damaged or is completely worn out.
- Do not discard battery in a fire. The battery pack can explode in a fire.
- Do not replace battery in any area labeled "Hazardous Atmosphere". Any sparks created in a potentially explosive atmosphere can cause an explosion or fire.
- Do not disassemble, crush, puncture, shred, or otherwise attempt to change the form of your battery.
- Do not dry a wet or damp battery with an appliance or heat source, such as a hair dryer or microwave oven.
- A small leakage of liquid from the battery cells may occur under extreme usage or temperature conditions. This does not indicate a failure. Do not open, deform or mutilate the battery as there may be corrosive materials which can cause damage to eyes or skin and may be toxic if swallowed.

However, if the outer seal is broken and this leakage gets on your skin:

- a. Wash quickly with soap and water.
- b. Neutralize with a mild acid such as lemon juice or vinegar.
- c. If battery liquid gets into your eyes, flush them with clean water for a minimum of 10 minutes and seek immediate medical attention.

This product uses Lithium Polymer Battery. Do not transport package if damaged, a fire hazard could exist.

For more information, please call our customer support line at (855) 224-5127, or email us at cs@shineflexglobal.com.

Recycle Battery

Local, state or federal laws may prohibit disposal of batteries in ordinary trash. Consult your local waste authority for information regarding available recycling and/or disposal options.



Introduction

Making Life Easier and Safer

Staying in touch is convenient and easy when using your radio. Some of the many uses you will discover include:

Communicating with others while hiking, biking, and working; keeping track of family and friends at a crowded public event; checking with travel companions; connecting with neighbors; arranging meeting spots with others while shopping at the mall, talking with your colleagues in store or warehouse.

Holster

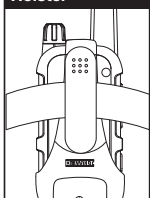

Secure your radio while on the go.

Carrying your radio with you is easy when using the holster.

The holster easily attaches to your belt, purse, or backpack.



Customer Assistance

Product Service & Support

For any questions about operating this new DEWALT branded product, PLEASE CONTACT US FIRST... do not return this product to the retail store. The contact information for support will vary depending on the country in which you purchased and utilize the product.

To obtain warranty service or other information for products purchased from Shine Flex itself or through its authorized reseller or agent and utilized in the U.S.A., please email us at cs@shineflexglobal.com. You will receive instructions on how to ship the products at your expense to an our Authorized Service Center. To obtain service, you must include: (a) a copy of your receipt, bill of sale or other comparable proof of purchase; (b) a written description of the problem; and, most importantly; (c) your address and telephone number.

For further information needed on its features, please visit www.shineflexglobal.com for frequently asked questions and the electronic manual.

© 2022 Shine Flex US LLC, Illinois, USA

⚠ CAUTION:

Exposure to high volume sound levels may cause temporary or permanent damage to your hearing. Although there is no single volume setting that is appropriate for everyone, you should always use your radio with the volume set at low level and avoid prolonged exposure to high volume sound levels.

1. Set the volume control in a low position and use as low a volume as possible.
2. Avoid turning up the volume to block out noisy surroundings. Whenever possible, use your radio in a quiet environment with low background noise.
3. Limit the amount of time you use headsets or earpiece at high volume levels.
4. When using the radio without a headset or earpiece, do not place the radio's speaker directly against your ear.
5. Observe all signs and instructions that require an electrical device or RF radio product to be switched off in designated areas, such as gas/refueling stations, hospitals, blasting areas, potentially explosive atmospheres, or aircraft.
6. If you experience a skin irritation after using this product, discontinue use and seek medical attention.
7. If the product or charger: overheats; has a damaged cord or plug; has been dropped or damaged; has been dropped into water, disconnect any charger from its power supply, discontinue use of the product.

Electromagnetic Interference

Nearly every electronic device is susceptible to electromagnetic interference (EMI) if inadequately shielded, designed, or otherwise configured for electromagnetic compatibility. Turn off your radio in any facility where posted notices instruct you to do so. These facilities may include hospitals or health care facilities that may be using equipment that is sensitive to external RF energy.

- When instructed to do so, turn off your radios when on board an aircraft. Any use of a RF device must be in accordance with applicable laws, regulations and airline crew instructions.
- Some radios may interfere with some hearing aids. In the event of such interference, you may want to consult your hearing aid manufacturer or physician to discuss alternatives.
- If you use any other personal medical device, consult the manufacturer of your device to determine if it is adequately shielded from RF energy. Your doctor or physician may be able to assist you in obtaining this information.



Introduction

Caring for Your Radio

Your radio will give you years of trouble-free service if cared for properly. Handle the radio gently. Keep the radio away from dust. Never put the radio in water or in a damp place. Avoid exposure to extreme temperatures.

Installing Batteries

Remove Holster



1. Remove Holster by releasing the belt clip latch and slide the holster downward.
2. Unscrew 3 screws at battery door with Philips #1 screwdriver, then open the battery compartment cover. Connect the connector of the battery to the socket of the radio inside the battery compartment.
3. Place the battery inside the battery compartment and align the wire as shown.

Battery Door Screws



- (Make sure the wire does not block the screw holes)
4. Replace the battery compartment cover, screw down the screws mildly.
(Screw nuts may be damaged if applying too strong force when tightening)

Battery connector

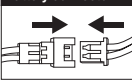

5. Re-attach the holster

To charge batteries in radio:

1. Check to see that the batteries have been inserted properly.
2. Insert the cable into the charge jack located at the left side of the radio.
3. Plug the cable into USB-compatible power port.

Wires alignment



Only use the supplied rechargeable batteries and desktop charger for recharging your DEWALT radio.

DEWALT recommends your radio is turned off while being charged.

NOTICE: To protect the lithium battery, the charging circuit allows the battery to be charged in environments ranging from 50°F (10°C) to 113°F (45°C).



Operation

Using Your Radio

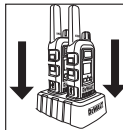

For charging radio(s) in desktop charger:

1. Insert radio(s) into desktop charger as shown.
2. Insert the USB-C cable into jack on back of charger.
3. Plug the cable into USB compatible power port. For pluggable equipment, the socket-outlet shall be installed near the equipment and shall be easily accessible.

To protect the lithium battery, the charging circuit allows the battery to be charged in environments ranging from 50°F (10°C) to 113°F (45°C).

If charging light is not **on**, check position of radio. Radio should be upright. The charge indicator light will stay **on** as long as the radio is in the charging mode, and the light will go **off** when charging is complete.

Note: To charge a single radio, you can bypass the desktop charger and simply insert the USB-C connector directly into the charge jack located on the left side of the radio.

The radio will display flashing battery icon while charging.

DEWALT recommends your radio be turned **off** while being charged.



Quick Start

1. Turn On/Off VOL Knob clockwise to turn the radio on and counter clockwise to turn the radio off.
2. Select a desired channel.



Both radios must be tuned to the same channel/privacy code to communicate.

3. Press and hold the **Talk** button while speaking into the microphone.
4. When finished talking, release the **Talk** button and listen for a response.



This radio is equipped with **default Privacy Code on each channel** for minimizing unwanted signals from others. See page 8 to 9 for procedures changing your radio from default Privacy Code to a different Privacy Code or disabling Privacy Code.

Turning on Your Radio

Turn  clockwise to turn the radio on and counterclockwise to turn the radio off.

1. In the ON position, the radio chirps and briefly shows all feature icons available on the radio.
2. The display screen then shows the current channel, code and all features that are enabled.

Battery Low

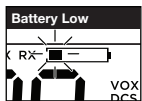

When battery power is low, the final bar in the **Battery Low** icon will blink and an audible tone will sound twice before the radio shuts off. Your batteries need to be recharged.



The radio will display flashing battery icon while charging if the radio is on.

Auto Battery Save

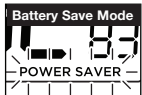

If there are no transmissions within 10 seconds, the radio will automatically switch to **Battery Save** mode and the **Power Saver** icon will flash in the display. This will not affect the radio's ability to receive incoming transmissions.



Helpful Tip

Accessories

Recommended accessories for use with your radios are available from your local dealer or authorized service center.

If you need assistance regarding accessories, please visit www.shineflexglobal.com

Communicating with Another Person



1. Press and hold the **Talk** button.
2. Position the microphone about two inches (5 cm) from your mouth, speak in a normal voice.
3. Release the **Talk** button when you are finished talking and listen for a response.

You cannot receive incoming calls while pressing the **Talk** button.



Both radios must be tuned to the same channel and privacy code to communicate.

To Select a Channel

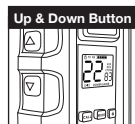

Press **Mode** button once, then press **Up** button or **Down** button.



Both radios must be tuned to the same channel to communicate.





See [page 12](#) for frequency allocations charts.

Listening for a Response



Release the **Talk** button to receive incoming transmissions. Your radio is always in **Standby** mode while the **Talk** or **Call** buttons are not pressed.

To Adjust Volume

1. Rotate  clockwise to increase the volume.
2. Rotate  counterclockwise to decrease the volume.

Do not hold the radio close to your ear. If the volume is set to an uncomfortable level, it could hurt your ear.

Call Button

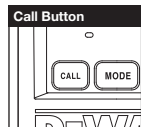

Press and release the **Call** button.

The other person will hear a three second call tone. This tone is used only to establish voice communications.

Auto Squelch

Your radio will automatically shut **off** weak transmissions and unwanted noise due to terrain, conditions limit.

Lock Function

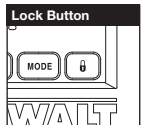

The **Lock** function locks the **Up**, **Down** and **Mode** buttons to prevent accidental operation.

To turn the lock on or off:

– Press and hold the **Lock** button for two seconds.

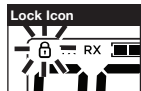

A double beep sound is used to confirm your lock **enabled**. When in **Lock** mode, the **Lock** icon will be displayed also.

Range



Your range will vary depending on terrain and conditions.

In flat, open country your radio will operate at maximum range.



Buildings and foliage in the path of the signal can reduce the range of the radio.

Dense foliage and hilly terrain will further reduce the range of the radio.



On Channels 8 through 14, your radio automatically switches to low power, which will limit the range the radio can communicate.



Operation

Mode Functions

Scrolling Through the Mode Function

By scrolling through the **Mode** function, you will be able to select or turn **on** preferred features of your radio. When scrolling through the **Mode** function, your radio features will be displayed in the same predetermined order:

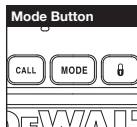

Channel	22 channels with default privacy code
↓	
VOX on/off	On or off shown on LCD
↓	
VOX sensitivity	5 levels
↓	
Vibration Alert selection	0:Off, 1:Enable
↓	
CTCSS code setting	38 codes for setting
↓	
DCS code setting	83 codes for setting

Privacy Codes

Your radio incorporates two advanced coded squelch systems that can help to reduce interference from other users on any given channel. CTCSS (Continuous Tone Coded Squelch System) provides 38 privacy codes and DCS (Digitally Coded Squelch) provides 83 privacy codes. This provides a total of 121 **Privacy Codes**. Either system can be used on all channels, but both systems cannot be used on the same channel at the same time.

For ease of use and reduce interference from other users, the 22 channels of your radio has been customized, see **Channel and Default Privacy Code Table**.

Channel and Default Privacy Code Table

Channel	Privacy Code	
	Type	Number
1	CTCSS	1
2	CTCSS	11
3	CTCSS	22
4	CTCSS	33
5	DCS	1
6	DCS	11
7	DCS	22
8	DCS	33
9	DCS	44
10	DCS	55
11	DCS	66

Channel	Privacy Code	
	Type	Number
12	DCS	77
13	CTCSS	1
14	CTCSS	11
15	CTCSS	22
16	CTCSS	33
17	DCS	1
18	DCS	11
19	DCS	22
20	DCS	33
21	DCS	44
22	DCS	55



You can change your radio to a different Privacy Codes for working with other radio with different privacy code or without privacy code. See page 8 and 9 for procedures.

Set CTCSS Privacy Codes

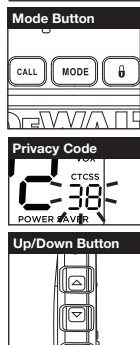

To select a CTCSS privacy code:

1. After selecting a channel, press the **Mode** button until the **CTCSS** icon appears and the small numbers next to the channel number flash on the display.



If DCS is turned on at the channel selected, the display will flash the CTCSS icon and "OFF." To switch from DCS to CTCSS, press the **Up** or **Down** button while the display is flashing "OFF." The display will then show the small numbers flashing and you will then be able to proceed to step 2.

2. Press using the **Up** or **Down** button to select a privacy code. You can hold the **Up** or **Down** button for fast advance.

3. When your desired CTCSS privacy code is displayed, choose one of the following:

- Press the **Mode** button to enter the new setting and proceed to other functions.
- Press the **Talk** button to return to **Standby** mode.
- Do not press any buttons for 6 seconds to return to **Standby** mode.

Set DCS Privacy Codes



To select a DCS privacy code:

1. After selecting a channel, press the **Mode** button until the DCS icon appears and the small numbers flash on the display (00 through 83).



If CTCSS is turned **on** at the channel selected, the display will flash the DCS icon and “OFF.” To switch from CTCSS to DCS, press the **Up** or **Down** button while the display is flashing “OFF.” The display will then show the small numbers flashing and you will then be able to proceed to step 2.

2. Press the **Up** or **Down** button to select a DCS privacy code. You can hold the **Up** or **Down** button for fast advance.
3. When DCS privacy code is displayed, choose one of the following:
 - a. Press the **Mode** button to enter the new setting and proceed to other functions.
 - b. Press the **Talk** or **Call** button to return to **Standby** mode.
 - c. Do not press any buttons for 6 seconds to enter the new settings and to return to **Standby** mode.



To successfully communicate using a privacy code, both the sending and receiving radios must be tuned to the same channel and to the same privacy code system (CTCSS or DCS) and privacy code number. Each channel will remember the last privacy code system and number you select.



The privacy code 00 is not a privacy code, but allows all signals to be heard on a channel that is set to 00 on both the CTCSS and DCS systems.

Voice Activated Transmit (VOX)

In **VOX** mode, your radio can be used “hands-free,” automatically transmitting when you speak. You can set the **VOX** sensitivity level to fit the volume of your voice and avoid transmissions triggered by background noise.

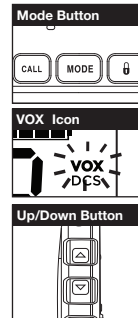

To turn **VOX** mode on or off:

1. Press the **Mode** button until the **VOX** icon shown on the display. The current **On** or **Off** setting is displayed.
2. Press the **Up** or **Down** button to turn **VOX On** or **Off**.
3. Choose one of the following:
 - a. Press the **Mode** button to enter the new setting and proceed to other functions.
 - b. Press the **Talk** or **Call** button to return to **Standby** mode.

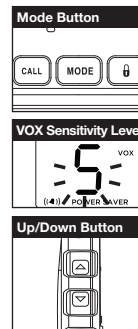

To set **VOX** sensitivity:

1. Press the **Mode** button until the **VOX** icon flashes and the current sensitivity level is displayed.
-  The current **VOX** sensitivity level is displayed with letters “L” and a Number 1 through 5, with Number 5 being the most sensitive level and Number 1 being the least sensitive level.
2. Press the **Up** or **Down** button to change the setting.
 3. Choose one of the following:
 - a. Press the **Mode** button to enter the new setting and proceed to other functions.
 - b. Press the **Talk** or **Call** button to return to **Standby** mode.
 - c. Do not press any buttons for 6 seconds to return to **Standby** mode.

Vibration Alert and Call Alert

Your radio can alert you to incoming signals by sounding an audible call tone or an audible tone with Vibration Alert.



To change call settings:

1. Press the **Mode** button until the **Call Setting** icon is shown on the display. The current setting ("0" ring only, "1" vibrate + ring) is displayed.
2. Press the **Up** or **Down** button to change the call setting.
3. Choose one of the following:
 - a. Press the **Mode** button to enter the new setting and proceed to other functions.
 - b. Press **Talk** or **Call** button to return to **Standby** mode.
 - c. Do not press any buttons for 6 seconds to return to **Standby** mode.

Note: Vibration Alert will be suspended during charging



Roger Beep Confirmation Tone

Your listener will hear an audible tone when you release the **Talk** button. This alerts the other party that you have finished talking and it is OK for them to speak.

Key Tone

Key Tone is an audible tone which will sound each time a button is pressed.

NOTE: Both Roger Beep and Key Tone can be toggled (Enabling or Disabling) as following.

To turn both Roger Beep and Key Tone on or off:

1. Turn **OFF** the radio.
2. Press and hold the **Call** button, and then turn **ON** the radio at the same time, tones enabling or disabling confirmation would be heard.
3. Release the **Call** button.



Operation

General Specifications

Frequency Allocation and Compatibility

A = Channel No. for 22 Channel Models

B = Frequency in MHz

C = Power Output

A	B	C
1	462.5625	High
2	462.5875	High
3	462.6125	High
4	462.6375	High
5	462.6625	High
6	462.6875	High
7	462.7125	High
8	467.5625	Low
9	467.5875	Low
10	467.6125	Low
11	467.6375	Low
12	467.6625	Low
13	467.6875	Low
14	467.7125	Low
15	462.5500	High
16	462.5750	High
17	462.6000	High
18	462.6250	High
19	462.6500	High
20	462.6750	High
21	462.7000	High
22	462.7250	High

IMPORTANT NOTICE:

Changes or modifications to this unit not expressly approved by the party responsible for compliance could void the user's authority to operate the equipment.

This device complies with Part 15 of the FCC Rules. Operation is subject to the following two conditions: 1) This device may not cause harmful interference, and 2) this device must accept any interference received, including interference that may cause undesired operation.

This equipment has been tested and found to comply with the limits for a Class B digital device, pursuant to Part 15 of the FCC Rules. These limits are designed to provide reasonable protection against harmful interference in a residential installation. This equipment generates, uses and radiate radio frequency energy and, if not installed and used in accordance with the instructions, may cause harmful interference to radio communications.

However, there is no guarantee that interference will not occur in a particular installation. If this equipment does cause harmful interference to radio or television reception, which can be determined by turning the equipment off and on, the user is encouraged to try to correct the interference by one or more of the following measures:

- Reorient or relocate the receiving antenna.
- Increase the separation between the equipment and receiver.
- Connect the equipment into an outlet on a circuit different from that to which the receiver is connected.
- Consult the dealer or an experienced radio/TV technician for help.

Safety Information for Radios

Your wireless handheld portable transceiver contains a low power transmitter. When the talk button is pushed, it sends out radio frequency (RF) signals. The device is authorized to operate at a duty factor not to exceed 50%. In August 1996, the Federal Communications Commissions (FCC) adopted RF exposure guidelines with safety levels for handheld wireless devices

Important

FCC RF Exposure Requirements: For body-worn operation, this radio has been tested and meets the FCC RF exposure guidelines when used with DeWALT accessories supplied or designated for this product. Use of other accessories may not ensure compliance with FCC RF exposure guidelines. Use only the supplied antenna. Unauthorized antennas, modifications or attachments could damage the transmitter and may violate FCC regulations.

Normal Position

Hold the transmitter approximately 1 inch (25mm) from your face and speak in a normal voice, with the antenna pointed up and away.

FCC Part 15.21 Warning Statement-

NOTE: THE GRANTEE IS NOT RESPONSIBLE FOR ANY CHANGES OR MODIFICATIONS NOT EXPRESSLY APPROVED BY THE PARTY RESPONSIBLE FOR COMPLIANCE. SUCH MODIFICATIONS COULD VOID THE USER'S AUTHORITY TO OPERATE THE EQUIPMENT.

ISED C Warning

This device complies with Innovation, Science, and Economic Development Canada licence-exempt RSS standard(s). Operation is subject to the following two conditions:

- (1) this device may not cause interference, and
- (2) this device must accept any interference, including interference that may cause undesired operation of the device.

Le présent appareil est conforme aux CNR d'Innovation, Sciences et Développement économique Canada applicables aux appareils radio exempts de licence. L'exploitation est autorisée aux deux conditions suivantes :

- (1) l'appareil ne doit pas produire de brouillage, et
- (2) l'utilisateur de l'appareil doit accepter tout brouillage radioélectrique subi, même si le brouillage est susceptible d'en compromettre le fonctionnement.

ISED Radiation Exposure Statement

For body worn operation, this model device has been tested and meets the ISED RF exposure guidelines when used with an accessory designated for this product or when used with an accessory that Contains no metal and that positions of the face up minimum distance is 25 mm.

Any Changes or modifications not expressly approved by the party responsible for compliance could void the user's authority to operate the equipment.

Pour le corps, ce modèle d'appareil a été testé et adapté à la RF renforcée Lignes directrices relatives à l'exposition lorsqu'elles sont utilisées avec un accessoire pour ce produit ou lorsqu'elles sont utilisées avec celui-ci Un accessoire ne contenant pas de métal et dont la distance minimale de la face est de 25 mm.

Tout changement ou modification non expressément approuvé par la partie responsable de la conformité à l'équipement.

Your wireless handheld portable transceiver contains a low power transmitter. When the talk button is pushed, it sends out radio frequency (RF) signals. The device is authorized to operate at a duty factor not to exceed 50%.

Votre émetteur-récepteur portable sans fil contient un émetteur de faible puissance. Lorsque le bouton de conversation est enfoncé, il envoie des signaux de radiofréquence (RF). L'appareil est autorisé à fonctionner avec un facteur d'utilisation ne dépassant pas 50%.



MODEL DXFRS800:

This device complies with part 15 of the FCC Rules. Operation is subject to the following two conditions: 1) This device may not cause harmful interference, and 2) this device must accept any interference received, including interference that may cause undesired operation.

FCC Warnings: Replacement or substitution of transistors, regular diodes or other parts of a unique nature, with parts other than those recommended by DeWALT may cause a violation of the technical regulations of part 95 of the FCC rules, or violation of type acceptance requirements of part 2 of the rules.

Warranty & Trademark Acknowledgment

Limited Lifetime Warranty on Radio

Shine Flex warrants to the original consumer purchaser only that this product and the component parts thereof, will be free from defects in workmanship and materials. During this period, Shine Flex will, repair or replace, at its sole option and discretion, this product or any defective parts. Shine Flex's liability hereunder shall be limited to repair or replacement of the defective part or parts, and such correction shall constitute a fulfillment of all of Shine Flex's warranties hereunder.

This limited warranty does not apply to accessories and consumables and is only valid for the original consumer purchaser in limited jurisdictions and is not transferrable. This limited warranty will automatically terminate prior to expiration if this product is sold or otherwise transferred to another party. The product must be purchased from Shine Flex or an authorized dealer or the warranty is void. This limited warranty is valid only for products purchased and utilized in specific jurisdictions. Please visit our website at www.shineflexglobal.com for a list of jurisdictions wherein this limited warranty is valid.

This limited warranty does not cover damage due to misuse, abuse, negligence, acts of God, accident, commercial use or modification of, or to any part of this product. This warranty does not cover damage due to improper operation, maintenance or installation; ordinary wear and tear; or attempted alterations or repairs by anyone other than Shine Flex or someone authorized by Shine Flex to do warranty work. Any unauthorized alterations or repairs will void this warranty. This limited warranty does not cover product sold AS IS or WITH ALL FAULTS. This limited warranty is invalid if the factory applied serial number or date stamp has been altered, defaced or removed from this product. This limited warranty does not cover product purchased or utilized in a jurisdiction not covered.

The procedure for obtaining service and support, and the applicability of this warranty, will vary depending on the country or jurisdiction in which you purchase and utilize the product. For details on obtaining product service, support and other warranty information please visit www.shineflexglobal.com.

This warranty gives you specific legal rights, and you may also have other rights which vary from state to state and country to country.

EXCEPT AS EXPRESSLY SET FORTH IN THIS WARRANTY, SHINE FLEX MAKES NO OTHER WARRANTIES, EXPRESSED OR IMPLIED, INCLUDING ANY IMPLIED WARRANTIES OF MERCHANTABILITY AND FITNESS FOR A PARTICULAR PURPOSE. SHINE FLEX EXPRESSLY DISCLAIMS ALL WARRANTIES NOT STATED IN THIS LIMITED WARRANTY. ANY IMPLIED WARRANTIES THAT MAY BE IMPOSED BY LAW ARE LIMITED TO THE TERMS OF THIS EXPRESSED WARRANTY.

LIMITATION OF REMEDIES AND DAMAGES. REPAIR OR REPLACEMENT AS PROVIDED UNDER THIS WARRANTY IS THE EXCLUSIVE REMEDY OF THE CONSUMER. SHINE FLEX SHALL NOT BE LIABLE FOR ANY INCIDENTAL OR CONSEQUENTIAL DAMAGES, INCLUDING BUT NOT LIMITED TO ATTORNEYS' FEES AND/OR COSTS OF LITIGATION, FOR BREACH OF ANY EXPRESS OR IMPLIED WARRANTY ON THIS PRODUCT. SHINE FLEX IS NOT LIABLE FOR ANY DAMAGES CAUSED BY THE PRODUCT OR BY THE PRODUCT TO PERFORM, INCLUDING ANY LOST PROFITS, LOST SAVINGS, INCIDENTAL DAMAGES, OR CONSEQUENTIAL DAMAGES. SHINE FLEX IS NOT LIABLE FOR ANY CLAIM MADE BY A THIRD PARTY OR MADE BY YOU FOR A THIRD PARTY. THIS LIMITATION APPLIES WHETHER DAMAGES ARE SOUGHT, OR A CLAIM



Notes

MADE, UNDER THIS WARRANTY OR AS A TORT CLAIM (INCLUDING NEGLIGENCE OR STRICT PRODUCT LIABILITY), A CONTRACT CLAIM, OR ANY OTHER CLAIM. THIS LIMITATION CANNOT BE WAIVED OR AMENDED BY ANY PERSON. THIS LIMITATION OF LIABILITY WILL BE EFFECTIVE EVEN IF SHINE FLEX OR AN AUTHORIZED REPRESENTATIVE OF SHINE FLEX HAS BEEN ADVISED BY YOU OF THE POSSIBILITY OF ANY SUCH DAMAGES.

Some states and countries do not allow limitations on how long an implied warranty lasts and do not allow the exclusion or limitation of incidental or consequential damages, so the above limitations may not apply to you. This warranty gives you specific legal rights, and you may also have other rights which vary from state to state and country to country.

Provided that the product was purchased from Shine Flex itself or through its authorized reseller or agent and utilized in the U.S.A., Shine Flex will, without charge, repair or replace, at its option, defective products, products or component parts upon delivery to the authorized Shine Flex Authorized Service Center, accompanied by proof of the date of first customer purchase, such as a duplicated copy of a sales receipt.

You must pay any initial shipping charges required to ship the product for warranty service, but the return charges, to an address in the U.S.A, will be at Shine Flex's expense, if the product is under warranty.

For Products Purchased Outside the U.S.A.

Please contact your authorized local reseller or agent for warranty information.

Trademark Acknowledgment

DeWALT® and the DeWALT Logo are trademarks of the DeWALT Industrial Tool Co., or an affiliate thereof and are used under license.

The yellow/black color scheme is a trademark for DeWALT power tools & accessories.

© 2022 DeWALT

U.S. & Canada Only

Product Manufactured by:

Shine Flex US LLC, Illinois, USA.

For product, service or warranty information contact us at:

www.shineflexglobal.com (855) 224-5127