



LEQISMART

LEQISMART ELECTRIC SCOOTER A8

USER MANUAL

More Information Visit
www.leqismart.com

Function

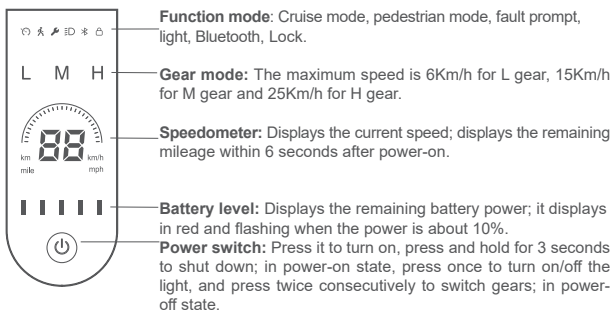
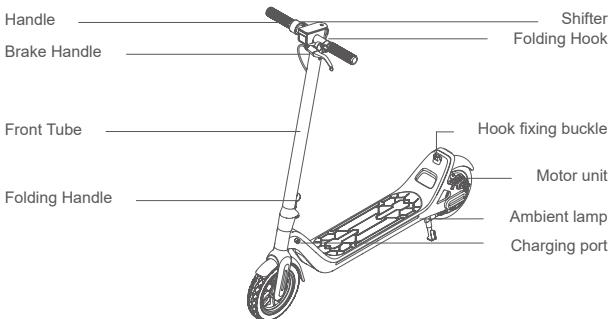

Packing List



User Manual



Service Card



Power Adapter



T-shape
Allen Key



Screw

Parameters

Model	A8
Net weight	15.5KG
Expanded size	112.4×44×118CM
Applicable age	16~50 years
Applicable height	130~200CM
Maximum load	100KG
Maximum speed	25Km/h
Distance per charge	About 40KM
Gradeability	About 15%
Protection grade	IPX5
Charging time	About 5.5 hours
BMS management	Over-charge, over-temperature, over-discharge, over-current, short circuit, over-voltage
Brake system	Manual disc brake + electronic brake
Connection method	Bluetooth
Tire size	9 inch tubeless tire

Assembly

1. Pull the folding handle upwards until there is a click sound, and pull the folding handle to confirm whether it is locked.
2. Manually connect the fixing seat and the data cable in the front tube, and check whether it is turned on normally.
3. Insert the fixing seat into the front tube, and use a hexagon wrench to tighten the six screws.



1

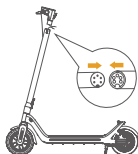

2

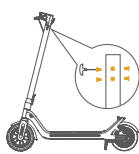

3

Charger Connection

1. Connect the charger to the power supply, and the indicator light of the charger turns green.
2. Insert the charging plug, and the indicator light turns from green to red.
3. After charging, the indicator light turns from red to green.

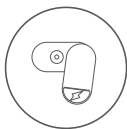
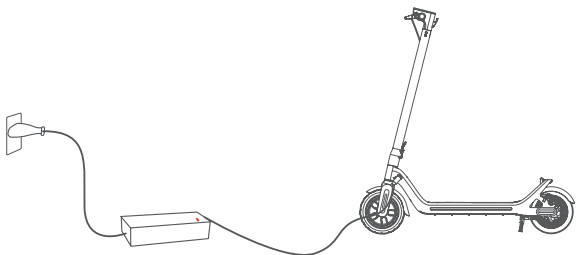

Lift up the rubber flap

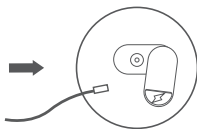

Plug the power adapter into the charging port

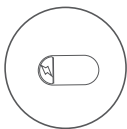

Put back the rubber flap.

i Attention:

1. The best charging ambient temperature is 0-45°C .
2. Use only the original power adapter when charging.
3. Keep away from children and animals while charging, and keep away from flammable objects.
4. Do not charge or use the battery if it smells, overheats or leaks.
5. There are dangerous substances in the battery. Do not open the battery pack or insert anything into the charging port.
6. When not in use for more than 30 days, please fully charge, store in a cool, dry place, and fully charge every 30 days.

Learn to Ride

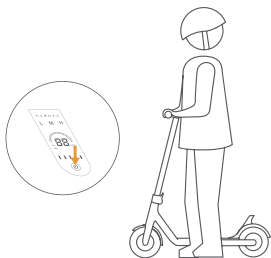

1. Press the power button to turn on the scooter and check the battery level. If the battery level is too low, please charge it in time.

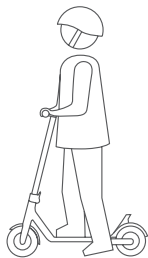

2. Stand with your right foot on the pedal and thrust against the ground with your left foot. When the speed of the scooter is $\geq 4\text{Km/h}$, start the motor.

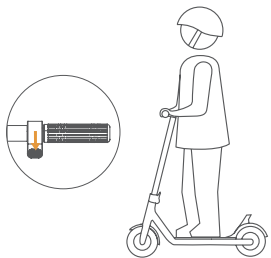

3. During the sliding, keep your balance, place the other foot on the pedal and lightly press the shifter to move forward.

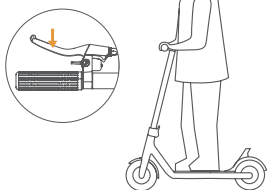

4. When steering or decelerating, release the shifter and use the brake lever to brake.

Fold

Turn off the scooter, press the red safety lock, and release the folding handle; fold the front tube clamp, align the folding hook and put it into the hook fixing buckle; lift the front tube and confirm whether it is fastened firmly.

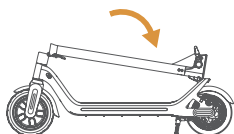
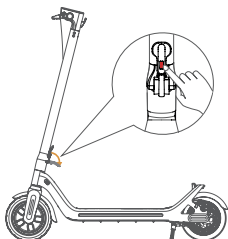

Unfold

Press the red button in the folding hook to remove the folding hook from the hook fixing buckle, straighten the front tube, close the folding handle until there is a “click” sound; flip the folding handle and confirm whether it is locked.

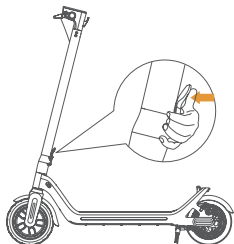
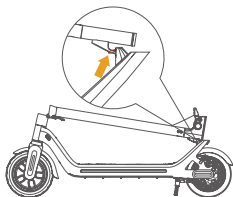

LEQISMART APP

Scan QR code with your mobile phone, or search "LEQISMART " in the Application market, download and install the APP.

- i** If the LEQISMART APP has been installed on your mobile phone, make sure that the APP is the latest.



STEP 1

Press the button to turn on the scooter and turn on the Bluetooth function of the mobile phone.



STEP 2

Open the LEQISMART APP. For the first use, please register/log in to your account according to the APP guide.



STEP 3

Enter on APP homepage, select "Search the binding".The APP will scan the scooter to be configured and add the device according to the prompt in the APP interface.

Safety Precautions

1. Please carefully read the User Manual, which will assist in explaining the basic working principles and provide tips on how to best enjoy your scooter experience.
2. Please wear all appropriate safety and protective gear as previously mentioned in the User Manual before operating the scooter.
3. Obligation to always wear shoes, Make sure to wear comfortable clothes.
4. A statement that accessories and any additional items which are not approved by the manufacturer shall not be used. Do not try to open or modify your scooter, as doing so will void your manufacturer warranty, and may cause failure to your device leading to serious bodily injury or death.
5. WARNING! Keep plastic covering away from children to avoid suffocation.
6. Do not operate the scooter while under the influence of drugs and/or alcohol.
7. Do not operate the scooter when you are restless or sleepy.
8. Use your best judgment to keep yourself out of dangerous situations with your scooter.
9. The scooters have a range of about 40KM and a maximum speed of 25Km/h.
10. Do not turn sharply, especially at high speeds.
11. Do not abuse your scooter, doing so can damage your unit and cause failure to the operating system leading to injury.
12. Do not drive in or near puddles of water, mud, sand, stones, gravel, debris or near rough and rugged terrain.
13. The scooter can be used on paved roads that are flat and even. If you encounter uneven pavement, please lift your scooter over and past the obstruction.
14. Do not ride in inclement weather: snow, rain, hail, sleet, on icy roads or in extreme heat.
15. Do not ride in or near pools or other large bodies of water.
16. Traffic in the city has many obstacles to cross such as curbs or steps. It is recommended to avoid obstacle jumps. It is important to anticipate and adapt your trajectory and speed to those of a pedestrian before crossing these obstacles. It is also recommended to get out of the vehicle when these obstacles become dangerous due to their shape, height or slippage.
17. Do not attempt to ride over bumps or objects greater than 1.5CM even when prepared and bending your knees.
18. PAY ATTENTION - look at where you are riding and be cognoscente of the road conditions, people, places, property and objects around you.
19. Do not operate the scooter in crowded areas.
20. Operate your scooter with extreme caution when indoors, especially around people, property, and narrow spaces like doorways and other narrow spaces.
21. Others recommendations such as: special precautions for use at dark; not to touch the brake disc.
22. Do not operate the scooter while talking, texting, or looking at your phone.
23. Do not ride your scooter where it is not permitted.
24. Do not ride your scooter near motor vehicles or on public roads.
25. Do not climb or travel down steep hills with your scooter.
26. The scooter is intended for use by a single individual, Do not attempt to operate the scooter with two or more people.
27. A statement that any load attached to the handlebar will affect the stability of the vehicle. Do not carry anything while riding the scooter.
28. Individuals with lack of balance should not attempt to operate the scooter.
29. Women who are pregnant or are preparing for pregnancy should not operate the scooter.
30. Young children and the elderly should not operate the scooter without proper

instruction and supervision from a Certified scooter trainer.

31. At higher speeds, always take into consideration longer stopping distances.
32. Do not step forward off your scooter.
33. Do not attempt to jump on or off your scooter.
34. Do not attempt any stunts or tricks with your scooter.
35. Do not ride the scooter in dark or poorly lit areas.
36. Do not ride the scooter near or over potholes, cracks or uneven pavement.
37. Do not operate your scooter off-road.
38. Do not exceed the maximum weight limit of 100KG.
39. Avoid driving the scooter in unsafe places, including near areas with flammable gas, steam, liquid, dust, fiber, which could cause fire and explosion accidents.
40. Scooter users are recommended to be 14 to 60 years and 130 to 200CM tall.
41. In any case, anticipate your trajectory and your speed while respecting the code of the road, the code of the sidewalk and the most vulnerable.
42. Notify your presence when approaching a pedestrian or cyclist when you are not seen or heard.
43. Cross the protected passages while walking.
44. In all cases, take care of yourself and others.
45. Do not divert the use of the vehicle.
46. This vehicle is not intended for acrobatic use.
47. Caution, the brake may become hot in use. Do not touch after use.
48. Warning aiming to draw the user's attention to any damages related to intensive use and to recommend periodic inspections of the frame, fork and suspension attachments (if any).
49. Regularly check the tightening of the various bolted elements, in particular the wheel axles, the folding system, the steering system and the brake shaft.
50. Do not modify or transform the vehicle, including the steering tube and sleeve, stem, folding mechanism and rear brake.
51. For pneumatic tires, the recommended maximum tire pressure is 45-50Psi.
52. Warning aiming to draw the user's attention to any damages related to intensive use and to recommend periodic inspections of the frame, fork and suspension attachments (if any).
53. **WARNING !** As with any mechanical component, a vehicle is subject to high stresses and wear. The various materials and components may react differently to wear or fatigue. If the expected service life for a component has been exceeded, it may break suddenly, therefore risking causing injuries to the user. Cracks, scratches and discoloration in the areas subject to high stresses indicate that the component has exceeded its service life and should be replaced.
54. List regarding the maintenance that can be performed by the user himself; Instructions for routine inspection, maintenance, cleaning and/or cleaning. Instructions for routine inspection, maintenance, cleaning and/or cleaning.
55. Instructions covering all functions of the vehicle, specially driving power assistance start mode (e.g. pushing the vehicle by more than 4 km/h and activating the power assistance mode).
56. Do not place the scooter in a high temperature higher than 50°C or a low temperature lower than -20°C (for example, do not put the scooter in a car exposed to the sun in summer). Do not put the scooter into a fire, otherwise it may lead to battery failure, overheating, and even fire risk.
57. Environmental conditions (e.g. outdoor or indoor charging); requirement to power-off the vehicle during charging, or into a certain non-operational mode.
58. When not in use for more than 30 days, fully charge, store in a cool, dry place,

and fully charge every 30 days.

59. The equipment contains a radio transmitting module with type approval code CMIIT ID:2021DP11017; Do not use wireless devices in places where the use of wireless devices is prohibited. Otherwise, it may interfere with other electronic devices or cause other risks.

60. Take the time to learn the basics of the practice to avoid any serious accident that can take place in the first months.

61. An instruction to keep the printed instructions for further reference and to be read carefully before use.

Cleaning and Storage

If there are stains on the surface of the scooter, use a soft cloth to dip in a small amount of water to wipe; If there are stains that are difficult to clean, smear them with toothpaste and brush them repeatedly, then clean them with a damp cloth. If the plastic parts of the body are scratched, use sandpaper or other abrasive materials to polish them.

Attention:

Do not use alcohol, gasoline, kerosene or other corrosive and volatile chemical solvents to clean, otherwise it will seriously damage the appearance and internal structure of the car body. It is forbidden to use pressure water gun to spray and wash. Ensure that the scooter is off and the charging port rubber cover is tightly fastened during cleaning, otherwise electric shock or serious failure may occur due to internal water inflow. When not in use, store in a dry and cool place indoors. Avoid outdoor storage for a long time. Long-term sun exposure, overheating and cold outdoor environment will accelerate the appearance and tire aging of the scooter, and reduce the service life of the scooter and battery pack.

Tire inflation maintenance

This product tire is vacuum tire, when the tire height sinks 20%-30%, need to inflate. The recommended tire pressure is 45-50Psi after inflation, and the tire should be inflated at least once every 2-3 months. Regular inflation and cleaning of tire surface debris can prolong the service life of the tire.

Battery Maintenance

1. Do not use battery packs of other models or brands, or else there may be safety risks.
2. It is strictly forbidden to disassemble, squeeze, or puncture this product; it is forbidden to throw this product into water, fire (including heat sources such as stove, heater, etc.) or expose it to

an environment with a temperature higher than 50°C.

3. Water entering the battery may cause damage to the internal circuit, and there is a risk of fire or even explosion; if the battery is suspected of water entering, please stop using it immediately and contact the after-sales service.

4. Do not touch the battery contacts, disassemble or puncture the case. Avoid metal objects contacting the battery contacts, or else it may cause short circuits, damage to the battery or personal injury or death.

5. Avoid recharging after the battery is completely depleted, and try to charge as soon as possible, so as to prolong the service life of the battery.

6. Only use the original power adapter when charging, or else there is a danger of damage or fire.

7. Please fully charge the battery before storing after each use, which will help to extend the battery life.

8. Do not place the scooter in an environment above 50°C or below -20°C (for example: in a car exposed to the sun in summer). It is forbidden to throw the scooter into a fire, or else it may cause the battery to fail, overheat, and even cause fire.

9. When used at normal temperature, the battery pack can exert a higher range and performance; if used in an environment below 0°C, the battery life and performance will decrease. For details, please refer to the remaining mileage display in the APP.

10. If it won't be used for a long time, please fully charge it first, store in a cool and dry place, and fully charge it every 30 days, or else the battery may be damaged and such damage is not covered by the warranty.

11. Improper disposal of used batteries may seriously pollute the environment. Please abide by local regulations when disposing of the battery pack. Do not throw away the battery pack in order to protect the natural environment.

Environmental Protection

This product contains battery or recyclable electronic waste, and the built-in rechargeable battery contains substances that may pollute the environment. When disposing of the product, please do not pile it with general household waste, but hand it to the electronic waste collection point designated by the state, which is beneficial to environmental protection.

ShenZhen LEQI Intelligent Technology Co., Ltd.

Address: Factory Room 202, No. 340 Guihua Road, Guixiang Community,
Guanlan Sub-district, Longhua District, Shenzhen, Guangdong, China

Tel: +86 400-088-7917 Web:www.leqismart.com

Federal Communications Commission (FCC) Statement. This device complies with part 15 of the FCC Rules. Operation is subject to the following two conditions:

- (1) This device may not cause harmful interference, and
- (2) this device must accept any interference received,

including interference that may cause undesired operation. Note: This equipment has been tested and found to comply with the limits for a Class B digital device, pursuant to part 15 of the FCC Rules. These limits are designed to provide Reasonable protection against harmful interference in a residential installation. This equipment generates, uses and can radiate radio frequency energy and, if not installed and used in accordance with the instructions, may cause harmful interference to radio communications. However, there is no guarantee that interference will not occur in a particular installation. If this equipment does cause harmful interference to radio or television reception, which can be determined by turning the equipment off and on, the user is encouraged to try to correct the interference by one or more of the following measures:

- Reorient or relocate the receiving antenna.
- Increase the separation between the equipment and receiver.
- Connect the equipment into an outlet on a circuit different from that to which the receiver is connected.
- Consult the dealer or an experienced radio/TV technician for help.

Warning: Changes or modifications made to this device not expressly approved by **Shenzhen LEQI Intelligent Technology Co., Ltd.** may void the FCC authorization to operate this device. Note: The manufacturer is not responsible for any radio or TV interference caused by unauthorized modifications to this equipment. Such modifications could void the user's authority to operate the equipment.

RF exposure statement:

The device complies RF exposure requirement and can be installed and used without restriction